

Keysight InfiniiVision 3000T X-Series Oscilloscopes

Notices

© Keysight Technologies, Inc. 2005-2016

No part of this manual may be reproduced in any form or by any means (including electronic storage and retrieval or translation into a foreign language) without prior agreement and written consent from Keysight Technologies, Inc. as governed by United States and international copyright laws.

Revision

Version 04.08.0000

Edition

July 15, 2016

Available in electronic format only

Published by:
Keysight Technologies, Inc.
1900 Garden of the Gods Road
Colorado Springs, CO 80907 USA

Warranty

The material contained in this document is provided "as is," and is subject to being changed, without notice, in future editions. Further, to the maximum extent permitted by applicable law, Keysight disclaims all warranties, either express or implied, with regard to this manual and any information contained herein, including but not limited to the implied warranties of merchantability and fitness for a particular purpose. Keysight shall not be liable for errors or for incidental or consequential damages in connection with the furnishing, use, or performance of this document or of any information contained herein. Should Keysight and the user have a separate written agreement with warranty terms covering the material in this document that conflict with these terms, the warranty terms in the separate agreement shall control.

Technology License

The hardware and/or software described in this document are furnished under a license and may be used or copied only in accordance with the terms of such license.

U.S. Government Rights

The Software is "commercial computer software," as defined by Federal Acquisition Regulation ("FAR") 2.101. Pursuant to FAR 12.212 and 27.405-3 and Department of Defense FAR Supplement ("DFARS") 227.7202, the U.S. government acquires commercial computer software under the same terms by which the software is customarily provided to the public. Accordingly, Keysight provides the Software to U.S. government customers under its standard commercial license, which is embodied in its End User License Agreement (EULA), a copy of which can be found at www.keysight.com/find/sweula. The license set forth in the EULA represents the exclusive authority by which the U.S. government may use, modify, distribute, or disclose the Software. The EULA and the license set forth therein, does not require or permit, among other things, that Keysight: (1) Furnish technical information related to commercial computer software or commercial computer software documentation that is not customarily provided to the public; or (2) Relinquish to, or otherwise provide, the government rights in excess of these rights customarily provided to the public to use, modify, reproduce, release, perform, display, or disclose commercial computer software or commercial computer software documentation. No additional government requirements beyond those set forth in the EULA shall apply, except to the extent that those terms, rights, or licenses are explicitly required from all providers of commercial computer software pursuant to the FAR and the DFARS and are set forth specifically in writing elsewhere in the EULA. Keysight shall be under no obligation to update, revise or otherwise modify the Software. With respect to any technical data as defined by FAR 2.101, pursuant to FAR 12.211 and 27.404.2 and DFARS 227.7102, the U.S. government acquires no greater than Limited Rights as defined in FAR 27.401 or DFAR 227.7103-5 (c), as applicable in any technical data.

Safety Notices

CAUTION

A **CAUTION** notice denotes a hazard. It calls attention to an operating procedure, practice, or the like that, if not correctly performed or adhered to, could result in damage to the product or loss of important data. Do not proceed beyond a **CAUTION** notice until the indicated conditions are fully understood and met.

WARNING

A **WARNING** notice denotes a hazard. It calls attention to an operating procedure, practice, or the like that, if not correctly performed or adhered to, could result in personal injury or death. Do not proceed beyond a **WARNING** notice until the indicated conditions are fully understood and met.

In This Book

This book is your guide to programming the 3000T X-Series oscilloscopes:

Table 1 InfiniiVision 3000T X-Series Oscilloscope Models, Bandwidths, Sample Rates

Band width	100 MHz	200 MHz	350 MHz	500 MHz	1 GHz
Sample Rate (interleaved, non-interleaved)	5 GSa/s, 2.5 GSa/s	5 GSa/s, 2.5 GSa/s	5 GSa/s, 2.5 GSa/s	5 GSa/s, 2.5 GSa/s	5 GSa/s, 2.5 GSa/s
2-Channel + 16 Logic Channels MSO	MSO-X 3012T	MSO-X 3022T	MSO-X 3032T	MSO-X 3052T	MSO-X 3102T
4-Channel + 16 Logic Channels MSO	MSO-X 3014T	MSO-X 3024T	MSO-X 3034T	MSO-X 3054T	MSO-X 3104T
2-Channel DSO	DSO-X 3012T	DSO-X 3022T	DSO-X 3032T	DSO-X 3052T	DSO-X 3102T
4-Channel DSO	DSO-X 3014T	DSO-X 3024T	DSO-X 3034T	DSO-X 3054T	DSO-X 3104T

The first few chapters describe how to set up and get started:

- **Chapter 1**, “What’s New,” starting on page 37, describes programming command changes in the latest version of oscilloscope software.
- **Chapter 2**, “Setting Up,” starting on page 53, describes the steps you must take before you can program the oscilloscope.
- **Chapter 3**, “Getting Started,” starting on page 61, gives a general overview of oscilloscope program structure and shows how to program the oscilloscope using a few simple examples.
- **Chapter 4**, “Commands Quick Reference,” starting on page 75, is a brief listing of the 3000T X-Series oscilloscope commands and syntax.

The next chapters provide reference information on common commands, root level commands, other subsystem commands, and error messages:

- **Chapter 5**, “Common (*) Commands,” starting on page 187, describes commands defined by the IEEE 488.2 standard that are common to all instruments.
- **Chapter 6**, “Root (:) Commands,” starting on page 213, describes commands that reside at the root level of the command tree and control many of the basic functions of the oscilloscope.
- **Chapter 7**, “:ACQUIRE Commands,” starting on page 253, describes commands for setting the parameters used when acquiring and storing data.
- **Chapter 8**, “:BUS<n> Commands,” starting on page 267, describes commands that control all oscilloscope functions associated with the digital channels bus display.
- **Chapter 9**, “:CALIBRATE Commands,” starting on page 277, describes utility commands for determining the state of the calibration factor protection button.

- **Chapter 10**, “:CHANnel<n> Commands,” starting on page 289, describes commands that control all oscilloscope functions associated with individual analog channels or groups of channels.
- **Chapter 11**, “:COUNter Commands,” starting on page 313, describes commands that control the optional DSOXDMCTR counter analysis feature.
- **Chapter 12**, “:DEMO Commands,” starting on page 325, describes commands that control the education kit (Option EDU) demonstration signals that can be output on the oscilloscope's Demo 1 and Demo 2 terminals.
- **Chapter 13**, “:DIGital<d> Commands,” starting on page 333, describes commands that control all oscilloscope functions associated with individual digital channels.
- **Chapter 14**, “:DISPlay Commands,” starting on page 341, describes commands that control how waveforms, graticule, and text are displayed and written on the screen.
- **Chapter 15**, “:DVM Commands,” starting on page 359, describes commands that control the optional DSOXDVM digital voltmeter analysis feature.
- **Chapter 16**, “:EXTernal Trigger Commands,” starting on page 365, describes commands that control the input characteristics of the external trigger input.
- **Chapter 17**, “:FFT Commands,” starting on page 371, describes commands that control the FFT function in the oscilloscope.
- **Chapter 18**, “:FUNction<m> Commands,” starting on page 391, describes commands that control math waveforms.
- **Chapter 19**, “:HARDcopy Commands,” starting on page 431, describes commands that set and query the selection of hardcopy device and formatting options.
- **Chapter 20**, “:LISTer Commands,” starting on page 449, describes commands that turn on/off the Lister display for decoded serial data and get the Lister data.
- **Chapter 21**, “:MARKer Commands,” starting on page 453, describes commands that set and query the settings of X-axis markers (X1 and X2 cursors) and the Y-axis markers (Y1 and Y2 cursors).
- **Chapter 22**, “:MEASure Commands,” starting on page 475, describes commands that select automatic measurements (and control markers).
- **Chapter 23**, “:MEASure Power Commands,” starting on page 557, describes measurement commands that are available when the DSOX4PWR power measurements and analysis application is licensed and enabled.
- **Chapter 24**, “:MTEST Commands,” starting on page 581, describes commands that control the mask test features provided with Option LMT.
- **Chapter 25**, “:POD Commands,” starting on page 615, describes commands that control all oscilloscope functions associated with groups of digital channels.
- **Chapter 26**, “:POWER Commands,” starting on page 621, describes commands that control the DSOX4PWR power measurement application.

- **Chapter 27**, “:RECall Commands,” starting on page 715, describes commands that recall previously saved oscilloscope setups, reference waveforms, or masks.
- **Chapter 28**, “:SAVE Commands,” starting on page 725, describes commands that save oscilloscope setups, screen images, and data.
- **Chapter 29**, “:SBUS<n> Commands,” starting on page 755, describes commands that control oscilloscope functions associated with the serial decode bus and serial triggering.
- **Chapter 30**, “:SEARCh Commands,” starting on page 969, describes commands that control oscilloscope functions associated with searching for waveform events.
- **Chapter 31**, “:SYSTem Commands,” starting on page 1061, describes commands that control basic system functions of the oscilloscope.
- **Chapter 32**, “:TIMEbase Commands,” starting on page 1085, describes commands that control all horizontal sweep functions.
- **Chapter 33**, “:TRIGger Commands,” starting on page 1097, describes commands that control the trigger modes and parameters for each trigger type.
- **Chapter 34**, “:WAVEform Commands,” starting on page 1195, describes commands that provide access to waveform data.
- **Chapter 35**, “:WGEN<w> Commands,” starting on page 1231, describes commands that control waveform generator (Option WGN) functions and parameters.
- **Chapter 36**, “:WMEMory<r> Commands,” starting on page 1273, describes commands that control reference waveforms.
- **Chapter 37**, “Obsolete and Discontinued Commands,” starting on page 1283, describes obsolete commands which still work but have been replaced by newer commands and discontinued commands which are no longer supported.
- **Chapter 38**, “Error Messages,” starting on page 1341, lists the instrument error messages that can occur while programming the oscilloscope.

The command descriptions in this reference show upper and lowercase characters. For example, :AUToscale indicates that the entire command name is :AUTOSCALE. The short form, :AUT, is also accepted by the oscilloscope.

Then, there are chapters that describe programming topics and conceptual information in more detail:

- **Chapter 39**, “Status Reporting,” starting on page 1349, describes the oscilloscope's status registers and how to check the status of the instrument.
- **Chapter 40**, “Synchronizing Acquisitions,” starting on page 1373, describes how to wait for acquisitions to complete before querying measurement results or performing other operations with the captured data.
- **Chapter 41**, “More About Oscilloscope Commands,” starting on page 1383, contains additional information about oscilloscope programming commands.

Finally, there is a chapter that contains programming examples:

- **Chapter 42**, "Programming Examples," starting on page 1393.

**Mixed-Signal
Oscilloscope
Channel
Differences**

Because both the "analog channels only" oscilloscopes (DSO models) and the mixed-signal oscilloscopes (MSO models) have analog channels, topics that describe analog channels refer to all oscilloscope models. Whenever a topic describes digital channels, that information applies only to the mixed-signal oscilloscope models.

See Also

- For more information on using the SICL, VISA, and VISA COM libraries in general, see the documentation that comes with the Keysight IO Libraries Suite.
- For information on controller PC interface configuration, see the documentation for the interface card used (for example, the Keysight 82350B GPIB interface).
- For information on oscilloscope front-panel operation, see the *User's Guide*.
- For detailed connectivity information, refer to the *Keysight Technologies USB/LAN/GPIB Connectivity Guide*. For a printable electronic copy of the *Connectivity Guide*, direct your Web browser to www.keysight.com and search for "Connectivity Guide".
- For the latest versions of this and other manuals, see:
<http://www.keysight.com/find/3000T-X-Series-manual>

Contents

In This Book / 3

1 What's New

- What's New in Version 4.08 / 38
- What's New in Version 4.07 / 41
- What's New in Version 4.06 / 43
- What's New in Version 4.05 / 44
- Version 4.00 at Introduction / 46
- Command Differences From 4000 X-Series Oscilloscopes / 47

2 Setting Up

- Step 1. Install Keysight IO Libraries Suite software / 54
- Step 2. Connect and set up the oscilloscope / 55
 - Using the USB (Device) Interface / 55
 - Using the LAN Interface / 55
 - Using the GPIB Interface / 56
- Step 3. Verify the oscilloscope connection / 57

3 Getting Started

- Basic Oscilloscope Program Structure / 62
 - Initializing / 62
 - Capturing Data / 62
 - Analyzing Captured Data / 63

Programming the Oscilloscope /	64
Referencing the IO Library /	64
Opening the Oscilloscope Connection via the IO Library /	65
Initializing the Interface and the Oscilloscope /	65
Using :AUToscale to Automate Oscilloscope Setup /	66
Using Other Oscilloscope Setup Commands /	66
Capturing Data with the :DIGitize Command /	67
Reading Query Responses from the Oscilloscope /	69
Reading Query Results into String Variables /	70
Reading Query Results into Numeric Variables /	70
Reading Definite-Length Block Query Response Data /	70
Sending Multiple Queries and Reading Results /	71
Checking Instrument Status /	72
Other Ways of Sending Commands /	73
Telnet Sockets /	73
Sending SCPI Commands Using Browser Web Control /	73

4 Commands Quick Reference

Command Summary /	76
Syntax Elements /	183
Number Format /	183
<NL> (Line Terminator) /	183
[] (Optional Syntax Terms) /	183
{ } (Braces) /	183
::= (Defined As) /	183
< > (Angle Brackets) /	184
... (Ellipsis) /	184
n,...,p (Value Ranges) /	184
d (Digits) /	184
Quoted ASCII String /	184
Definite-Length Block Response Data /	184

5 Common (*) Commands

*CLS (Clear Status) /	191
*ESE (Standard Event Status Enable) /	192
*ESR (Standard Event Status Register) /	194
*IDN (Identification Number) /	196
*LRN (Learn Device Setup) /	197
*OPC (Operation Complete) /	198
*OPT (Option Identification) /	199

- *RCL (Recall) / 201
- *RST (Reset) / 202
- *SAV (Save) / 205
- *SRE (Service Request Enable) / 206
- *STB (Read Status Byte) / 208
- *TRG (Trigger) / 210
- *TST (Self Test) / 211
- *WAI (Wait To Continue) / 212

6 Root (:) Commands

- :ACTivity / 217
- :AER (Arm Event Register) / 218
- :AUToscale / 219
- :AUToscale:AMODE / 221
- :AUToscale:CHANnels / 222
- :AUToscale:FDEBug / 223
- :BLANk / 224
- :DIGitize / 225
- :HWEenable (Hardware Event Enable Register) / 227
- :HWERegister:CONDition (Hardware Event Condition Register) / 229
- :HWERegister[:EVENT] (Hardware Event Event Register) / 230
- :MTEenable (Mask Test Event Enable Register) / 231
- :MTERegister[:EVENT] (Mask Test Event Event Register) / 233
- :OPEE (Operation Status Enable Register) / 235
- :OPERegister:CONDition (Operation Status Condition Register) / 237
- :OPERegister[:EVENT] (Operation Status Event Register) / 239
- :OVLenable (Overload Event Enable Register) / 241
- :OVLRegister (Overload Event Register) / 243
- :PRINt / 245
- :RUN / 246
- :SERial / 247
- :SINGle / 248
- :STATus / 249
- :STOP / 250
- :TER (Trigger Event Register) / 251
- :VIEW / 252

7 :ACQUIRE Commands

- :ACQUIRE:COMPLete / 255
- :ACQUIRE:COUNt / 256
- :ACQUIRE:MODE / 257

:ACQUIRE:POINTS / 258
:ACQUIRE:SEGMENTED:ANALYZE / 259
:ACQUIRE:SEGMENTED:COUNT / 260
:ACQUIRE:SEGMENTED:INDEX / 261
:ACQUIRE:SRATE / 264
:ACQUIRE:TYPE / 265

8 :BUS<n> Commands

:BUS<n>:BIT<m> / 269
:BUS<n>:BITS / 270
:BUS<n>:CLEAR / 272
:BUS<n>:DISPLAY / 273
:BUS<n>:LABEL / 274
:BUS<n>:MASK / 275

9 :CALIBRATE Commands

:CALIBRATE:DATE / 279
:CALIBRATE:LABEL / 280
:CALIBRATE:OUTPUT / 281
:CALIBRATE:PROTECTED / 283
:CALIBRATE:START / 284
:CALIBRATE:STATUS / 285
:CALIBRATE:TEMPERATURE / 286
:CALIBRATE:TIME / 287

10 :CHANNEL<n> Commands

:CHANNEL<n>:BWLIMIT / 292
:CHANNEL<n>:COUPLING / 293
:CHANNEL<n>:DISPLAY / 294
:CHANNEL<n>:IMPEDANCE / 295
:CHANNEL<n>:INVERT / 296
:CHANNEL<n>:LABEL / 297
:CHANNEL<n>:OFFSET / 298
:CHANNEL<n>:PROBE / 299
:CHANNEL<n>:PROBE:HEAD[:TYPE] / 300
:CHANNEL<n>:PROBE:ID / 301
:CHANNEL<n>:PROBE:MMODEL / 302
:CHANNEL<n>:PROBE:RSENSE / 303
:CHANNEL<n>:PROBE:SKEW / 304
:CHANNEL<n>:PROBE:STYPE / 305
:CHANNEL<n>:PROBE:ZOOM / 306

:CHANnel<n>:PROTection / 307
:CHANnel<n>:RANGe / 308
:CHANnel<n>:SCALe / 309
:CHANnel<n>:UNITs / 310
:CHANnel<n>:VERNier / 311

11 :COUNter Commands

:COUNter:CURRent / 315
:COUNter:ENABle / 316
:COUNter:MODE / 317
:COUNter:NDIGits / 318
:COUNter:SOURce / 319
:COUNter:TOTAlize:CLEar / 320
:COUNter:TOTAlize:GATE:ENABle / 321
:COUNter:TOTAlize:GATE:POLarity / 322
:COUNter:TOTAlize:GATE:SOURce / 323
:COUNter:TOTAlize:SLOPe / 324

12 :DEMO Commands

:DEMO:FUNcTion / 326
:DEMO:FUNcTion:PHASe:PHASe / 330
:DEMO:OUTPut / 331

13 :DIGital<d> Commands

:DIGital<d>:DISPlay / 335
:DIGital<d>:LABel / 336
:DIGital<d>:POSition / 337
:DIGital<d>:SIZE / 338
:DIGital<d>:THReshold / 339

14 :DISPlay Commands

:DISPlay:ANNotation<n> / 344
:DISPlay:ANNotation<n>:BACKground / 345
:DISPlay:ANNotation<n>:COLor / 346
:DISPlay:ANNotation<n>:TEXT / 347
:DISPlay:ANNotation<n>:X1Position / 348
:DISPlay:ANNotation<n>:Y1Position / 349
:DISPlay:CLEar / 350
:DISPlay:DATA / 351
:DISPlay:INTensity:WAVEform / 352
:DISPlay:LABel / 353

:DISPlay:LABList / 354
:DISPlay:MENU / 355
:DISPlay:SIDebar / 356
:DISPlay:PERsistence / 357
:DISPlay:VECTors / 358

15 :DVM Commands

:DVM:ARANge / 360
:DVM:CURRent / 361
:DVM:ENABle / 362
:DVM:MODE / 363
:DVM:SOURce / 364

16 :EXTErnal Trigger Commands

:EXTErnal:BWLimit / 366
:EXTErnal:PROBe / 367
:EXTErnal:RANGe / 368
:EXTErnal:UNITs / 369

17 :FFT Commands

:FFT:AVERage:COUNT / 373
:FFT:CENTer / 374
:FFT:CLEar / 375
:FFT:DISPlay / 376
:FFT:DMODE / 377
:FFT:FREQuency:STARt / 379
:FFT:FREQuency:STOP / 380
:FFT:GATE / 381
:FFT:OFFSet / 382
:FFT:RANGe / 383
:FFT:REFerence / 384
:FFT:SCALE / 385
:FFT:SOURce1 / 386
:FFT:SPAN / 387
:FFT:VTYPe / 388
:FFT:WINDow / 389

18 :FUNCTion<m> Commands

:FUNCTion<m>:AVERage:COUNT / 396
:FUNCTion<m>:BUS:CLOCK / 397
:FUNCTion<m>:BUS:SLOPe / 398

:FUNCTION<m>:BUS:YINCrement / 399
 :FUNCTION<m>:BUS:YORigin / 400
 :FUNCTION<m>:BUS:YUNits / 401
 :FUNCTION<m>:CLEar / 402
 :FUNCTION<m>:DISPlay / 403
 :FUNCTION<m>[:FFT]:CENTer / 404
 :FUNCTION<m>[:FFT]:FREQuency:START / 405
 :FUNCTION<m>[:FFT]:FREQuency:STOP / 406
 :FUNCTION<m>[:FFT]:GATE / 407
 :FUNCTION<m>[:FFT]:PHASe:REFeRence / 408
 :FUNCTION<m>[:FFT]:SPAN / 409
 :FUNCTION<m>[:FFT]:VTYPE / 410
 :FUNCTION<m>[:FFT]:WINDow / 411
 :FUNCTION<m>:FREQuency:HIGHpass / 412
 :FUNCTION<m>:FREQuency:LOWPass / 413
 :FUNCTION<m>:INTEgrate:IOFFset / 414
 :FUNCTION<m>:LINear:GAIN / 415
 :FUNCTION<m>:LINear:OFFSet / 416
 :FUNCTION<m>:OFFSet / 417
 :FUNCTION<m>:OPERation / 418
 :FUNCTION<m>:RANGe / 422
 :FUNCTION<m>:REFeRence / 423
 :FUNCTION<m>:SCALE / 424
 :FUNCTION<m>:SMOoth:POINTs / 425
 :FUNCTION<m>:SOURce1 / 426
 :FUNCTION<m>:SOURce2 / 428
 :FUNCTION<m>:TRENd:MEASurement / 429

19 :HARDcopy Commands

:HARDcopy:AREA / 433
 :HARDcopy:APRinter / 434
 :HARDcopy:FACTors / 435
 :HARDcopy:FFEed / 436
 :HARDcopy:INKSaver / 437
 :HARDcopy:LAYout / 438
 :HARDcopy:NETWork:ADDResS / 439
 :HARDcopy:NETWork:APPLY / 440
 :HARDcopy:NETWork:DOMain / 441
 :HARDcopy:NETWork:PASSword / 442
 :HARDcopy:NETWork:SLOT / 443
 :HARDcopy:NETWork:USERname / 444

:HARDcopy:PALETTE / 445
:HARDcopy:PRINter:LIST / 446
:HARDcopy:STARt / 447

20 :LISTer Commands

:LISTer:DATA / 450
:LISTer:DISPlay / 451
:LISTer:REFerence / 452

21 :MARKer Commands

:MARKer:DYDX / 456
:MARKer:MODE / 457
:MARKer:X1:DISPlay / 458
:MARKer:X1Position / 459
:MARKer:X1Y1source / 460
:MARKer:X2:DISPlay / 461
:MARKer:X2Position / 462
:MARKer:X2Y2source / 463
:MARKer:XDELta / 464
:MARKer:XUNits / 465
:MARKer:XUNits:USE / 466
:MARKer:Y1:DISPlay / 467
:MARKer:Y1Position / 468
:MARKer:Y2:DISPlay / 469
:MARKer:Y2Position / 470
:MARKer:YDELta / 471
:MARKer:YUNits / 472
:MARKer:YUNits:USE / 473

22 :MEASure Commands

:MEASure:ALL / 492
:MEASure:AREa / 493
:MEASure:BRATe / 494
:MEASure:BWIDth / 495
:MEASure:CLEar / 496
:MEASure:COUNter / 497
:MEASure:DEFine / 499
:MEASure:DELay / 502
:MEASure:DUAL:CHARge / 504
:MEASure:DUAL:VAMPLitude / 505
:MEASure:DUAL:VAVerage / 506

:MEASure:DUAL:VBASe / 507
:MEASure:DUAL:VPP / 508
:MEASure:DUAL:VRMS / 509
:MEASure:DUTYcycle / 510
:MEASure:FALLtime / 511
:MEASure:FREQuency / 512
:MEASure:NDUTy / 513
:MEASure:NEDGes / 514
:MEASure:NPULses / 515
:MEASure:NWIDth / 516
:MEASure:OVERshoot / 517
:MEASure:PEDGes / 519
:MEASure:PERiod / 520
:MEASure:PHASe / 521
:MEASure:PPULses / 522
:MEASure:PREShoot / 523
:MEASure:PWIDth / 524
:MEASure:RESults / 525
:MEASure:RISetime / 528
:MEASure:SDEViation / 529
:MEASure:SHOW / 530
:MEASure:SOURce / 531
:MEASure:STATistics / 533
:MEASure:STATistics:DISPlay / 534
:MEASure:STATistics:INCRement / 535
:MEASure:STATistics:MCOunt / 536
:MEASure:STATistics:RESet / 537
:MEASure:STATistics:RSDeViation / 538
:MEASure:TEDGe / 539
:MEASure:TVALue / 541
:MEASure:VAMPLitude / 543
:MEASure:VAverage / 544
:MEASure:VBASe / 545
:MEASure:VMAX / 546
:MEASure:VMIN / 547
:MEASure:VPP / 548
:MEASure:VRATio / 549
:MEASure:VRMS / 550
:MEASure:VTIMe / 551
:MEASure:VTOp / 552
:MEASure:WINDow / 553
:MEASure:XMAX / 554

:MEASure:XMIn / 555

23 :MEASure Power Commands

:MEASure:ANGLe / 561
:MEASure:APParent / 562
:MEASure:CPLoss / 563
:MEASure:CRESt / 564
:MEASure:EFFiciency / 565
:MEASure:ELOSs / 566
:MEASure:FACTor / 567
:MEASure:IPOWer / 568
:MEASure:OFFTime / 569
:MEASure:ONTime / 570
:MEASure:OPOWer / 571
:MEASure:PCURrent / 572
:MEASure:PLOSs / 573
:MEASure:RDSON / 574
:MEASure:REACTive / 575
:MEASure:REAL / 576
:MEASure:RIPple / 577
:MEASure:TRESponse / 578
:MEASure:VCESat / 579

24 :MTEST Commands

:MTEST:ALL / 586
:MTEST:AMASK:CREate / 587
:MTEST:AMASK:SOURce / 588
:MTEST:AMASK:UNITs / 589
:MTEST:AMASK:XDELta / 590
:MTEST:AMASK:YDELta / 591
:MTEST:COUNt:FWAVEforms / 592
:MTEST:COUNt:RESet / 593
:MTEST:COUNt:TIME / 594
:MTEST:COUNt:WAVEforms / 595
:MTEST:DATA / 596
:MTEST:DELeTe / 597
:MTEST:ENABle / 598
:MTEST:LOCK / 599
:MTEST:RMODE / 600
:MTEST:RMODE:FACTion:MEASure / 601
:MTEST:RMODE:FACTion:PRINt / 602

:MTEST:RMODE:FACTion:SAVE / 603
:MTEST:RMODE:FACTion:STOP / 604
:MTEST:RMODE:SIGMa / 605
:MTEST:RMODE:TIME / 606
:MTEST:RMODE:WAVEforms / 607
:MTEST:SCALE:BIND / 608
:MTEST:SCALE:X1 / 609
:MTEST:SCALE:XDELta / 610
:MTEST:SCALE:Y1 / 611
:MTEST:SCALE:Y2 / 612
:MTEST:SOURce / 613
:MTEST:TITLe / 614

25 :POD Commands

:POD<n>:DISPlay / 617
:POD<n>:SIZE / 618
:POD<n>:THReshold / 619

26 :POWER Commands

:POWER:CLResponse / 628
:POWER:CLResponse:APPLY / 629
:POWER:CLResponse:DATA / 630
:POWER:CLResponse:FREQuency:MODE / 631
:POWER:CLResponse:FREQuency:START / 632
:POWER:CLResponse:FREQuency:STOP / 633
:POWER:CLResponse:PPDecade / 634
:POWER:CLResponse:SOURce:INPut / 635
:POWER:CLResponse:SOURce:OUTPut / 636
:POWER:CLResponse:WGEN:LOAD / 637
:POWER:CLResponse:WGEN:VOLTage / 638
:POWER:CLResponse:WGEN:VOLTage:PROFile / 639
:POWER:DESKew / 640
:POWER:EFFiciency:APPLY / 641
:POWER:EFFiciency:TYPE / 642
:POWER:ENABLE / 643
:POWER:HARMonics:APPLY / 644
:POWER:HARMonics:DATA / 645
:POWER:HARMonics:DISPlay / 646
:POWER:HARMonics:FAILcount / 647
:POWER:HARMonics:LINE / 648
:POWER:HARMonics:POWERfactor / 649

:POWer:HARMonics:RPOWer / 650
:POWer:HARMonics:RPOWer:USER / 651
:POWer:HARMonics:RUNCount / 652
:POWer:HARMonics:STANdard / 653
:POWer:HARMonics:STATus / 654
:POWer:HARMonics:THD / 655
:POWer:INRush:APPLy / 656
:POWer:INRush:EXIT / 657
:POWer:INRush:NEXt / 658
:POWer:ITYPe / 659
:POWer:MODulation:APPLy / 660
:POWer:MODulation:SOURce / 661
:POWer:MODulation:TYPE / 662
:POWer:ONOff:APPLy / 663
:POWer:ONOff:EXIT / 664
:POWer:ONOff:NEXt / 665
:POWer:ONOff:TEST / 666
:POWer:ONOff:THResholds / 667
:POWer:PSRR / 669
:POWer:PSRR:APPLy / 670
:POWer:PSRR:DATA / 671
:POWer:PSRR:FREQuency:MAXimum / 672
:POWer:PSRR:FREQuency:MINimum / 673
:POWer:PSRR:FREQuency:MODE / 674
:POWer:PSRR:PPDecade / 675
:POWer:PSRR:SOURce:INPut / 676
:POWer:PSRR:SOURce:OUTPut / 677
:POWer:PSRR:WGEN:LOAD / 678
:POWer:PSRR:WGEN:VOLTage / 679
:POWer:PSRR:WGEN:VOLTage:PROFile / 680
:POWer:QUALity:APPLy / 681
:POWer:RIPPlE:APPLy / 682
:POWer:SIGNals:AUTosetup / 683
:POWer:SIGNals:CYCLes:HARMonics / 684
:POWer:SIGNals:CYCLes:QUALity / 685
:POWer:SIGNals:DURation:EFFiciency / 686
:POWer:SIGNals:DURation:MODulation / 687
:POWer:SIGNals:DURation:ONOff:OFF / 688
:POWer:SIGNals:DURation:ONOff:ON / 689
:POWer:SIGNals:DURation:RIPPlE / 690
:POWer:SIGNals:DURation:TRANsient / 691
:POWer:SIGNals:IEXPected / 692

:POWer:SIGNals:OVERshoot / 693
:POWer:SIGNals:VMAXimum:INRush / 694
:POWer:SIGNals:VMAXimum:ONOff:OFF / 695
:POWer:SIGNals:VMAXimum:ONOff:ON / 696
:POWer:SIGNals:VSTeady:ONOff:OFF / 697
:POWer:SIGNals:VSTeady:ONOff:ON / 698
:POWer:SIGNals:VSTeady:TRANsient / 699
:POWer:SIGNals:SOURce:CURRent<i> / 700
:POWer:SIGNals:SOURce:VOLTage<i> / 701
:POWer:SLEW:APPLy / 702
:POWer:SLEW:SOURce / 703
:POWer:SWITCh:APPLy / 704
:POWer:SWITCh:CONDUction / 705
:POWer:SWITCh:IREFERENCE / 706
:POWer:SWITCh:RDS / 707
:POWer:SWITCh:VCE / 708
:POWer:SWITCh:VREFERENCE / 709
:POWer:TRANsient:APPLy / 710
:POWer:TRANsient:EXIT / 711
:POWer:TRANsient:INInitial / 712
:POWer:TRANsient:INEW / 713
:POWer:TRANsient:NEXT / 714

27 :RECall Commands

:RECall:ARBitrary[:START] / 717
:RECall:DBC[:START] / 718
:RECall:FILEname / 719
:RECall:LDF[:START] / 720
:RECall:MASK[:START] / 721
:RECall:PWD / 722
:RECall:SETup[:START] / 723
:RECall:WMEMemory<r>[:START] / 724

28 :SAVE Commands

:SAVE:ARBitrary[:START] / 729
:SAVE:FILEname / 730
:SAVE:IMAGe[:START] / 731
:SAVE:IMAGe:FACTors / 732
:SAVE:IMAGe:FORMat / 733
:SAVE:IMAGe:INKSaver / 734
:SAVE:IMAGe:PALette / 735

- :SAVE:LISTer[:START] / 736
- :SAVE:MASK[:START] / 737
- :SAVE:MULTi[:START] / 738
- :SAVE:POWer[:START] / 739
- :SAVE:PWD / 740
- :SAVE:RESults[:START] / 741
- :SAVE:RESults:FORMat:CURSor / 742
- :SAVE:RESults:FORMat:MASK / 743
- :SAVE:RESults:FORMat:MEASurement / 744
- :SAVE:RESults:FORMat:SEARch / 745
- :SAVE:RESults:FORMat:SEGmented / 746
- :SAVE[:SETup[:START]] / 747
- :SAVE:WAVEform[:START] / 748
- :SAVE:WAVEform:FORMat / 749
- :SAVE:WAVEform:LENGth / 750
- :SAVE:WAVEform:LENGth:MAX / 751
- :SAVE:WAVEform:SEGmented / 752
- :SAVE:WMEMory:SOURce / 753
- :SAVE:WMEMory[:START] / 754

29 :SBUS<n> Commands

- General :SBUS<n> Commands / 757
 - :SBUS<n>:DISPlay / 758
 - :SBUS<n>:MODE / 759
- :SBUS<n>:A429 Commands / 760
 - :SBUS<n>:A429:AUTosetup / 762
 - :SBUS<n>:A429:BASE / 763
 - :SBUS<n>:A429:COUNt:ERRor / 764
 - :SBUS<n>:A429:COUNt:RESet / 765
 - :SBUS<n>:A429:COUNt:WORD / 766
 - :SBUS<n>:A429:FORMat / 767
 - :SBUS<n>:A429:SIGNal / 768
 - :SBUS<n>:A429:SOURce / 769
 - :SBUS<n>:A429:SPEed / 770
 - :SBUS<n>:A429:TRIGger:LABel / 771
 - :SBUS<n>:A429:TRIGger:PATtern:DATA / 772
 - :SBUS<n>:A429:TRIGger:PATtern:SDI / 773
 - :SBUS<n>:A429:TRIGger:PATtern:SSM / 774
 - :SBUS<n>:A429:TRIGger:RANGe / 775
 - :SBUS<n>:A429:TRIGger:TYPE / 776
- :SBUS<n>:CAN Commands / 777

- :SBUS<n>:CAN:COUNT:ERRor / 780
- :SBUS<n>:CAN:COUNT:OVERload / 781
- :SBUS<n>:CAN:COUNT:RESet / 782
- :SBUS<n>:CAN:COUNT:SPEC / 783
- :SBUS<n>:CAN:COUNT:TOTal / 784
- :SBUS<n>:CAN:COUNT:UTILization / 785
- :SBUS<n>:CAN:DISPlay / 786
- :SBUS<n>:CAN:FDSPoint / 787
- :SBUS<n>:CAN:FDSTandard / 788
- :SBUS<n>:CAN:SAMPlepoint / 789
- :SBUS<n>:CAN:SIGNal:BAUDrate / 790
- :SBUS<n>:CAN:SIGNal:DEFinition / 791
- :SBUS<n>:CAN:SIGNal:FDBaudrate / 792
- :SBUS<n>:CAN:SOURce / 793
- :SBUS<n>:CAN:TRIGger / 794
- :SBUS<n>:CAN:TRIGger:IDFilter / 797
- :SBUS<n>:CAN:TRIGger:PATTern:DATA / 798
- :SBUS<n>:CAN:TRIGger:PATTern:DATA:DLC / 799
- :SBUS<n>:CAN:TRIGger:PATTern:DATA:LENGth / 800
- :SBUS<n>:CAN:TRIGger:PATTern:DATA:STARt / 801
- :SBUS<n>:CAN:TRIGger:PATTern:ID / 802
- :SBUS<n>:CAN:TRIGger:PATTern:ID:MODE / 803
- :SBUS<n>:CAN:TRIGger:SYMBolic:MESSage / 804
- :SBUS<n>:CAN:TRIGger:SYMBolic:SIGNal / 805
- :SBUS<n>:CAN:TRIGger:SYMBolic:VALue / 806
- :SBUS<n>:CXPI Commands / 807
 - :SBUS<n>:CXPI:BAUDrate / 809
 - :SBUS<n>:CXPI:PARity / 810
 - :SBUS<n>:CXPI:SOURce / 811
 - :SBUS<n>:CXPI:TOLerance / 812
 - :SBUS<n>:CXPI:TRIGger / 813
 - :SBUS<n>:CXPI:TRIGger:IDFilter / 815
 - :SBUS<n>:CXPI:TRIGger:PTYPE / 816
 - :SBUS<n>:CXPI:TRIGger:PATTern:DATA / 817
 - :SBUS<n>:CXPI:TRIGger:PATTern:DATA:LENGth / 818
 - :SBUS<n>:CXPI:TRIGger:PATTern:DATA:STARt / 819
 - :SBUS<n>:CXPI:TRIGger:PATTern:ID / 820
 - :SBUS<n>:CXPI:TRIGger:PATTern:INFO:CT / 821
 - :SBUS<n>:CXPI:TRIGger:PATTern:INFO:DLC / 822
 - :SBUS<n>:CXPI:TRIGger:PATTern:INFO:NM / 823
- :SBUS<n>:FLEXray Commands / 824

```

:SBUS<n>:FLEXray:AUTosetup / 826
:SBUS<n>:FLEXray:BAUDrate / 827
:SBUS<n>:FLEXray:CHANnel / 828
:SBUS<n>:FLEXray:COUNt:NULL / 829
:SBUS<n>:FLEXray:COUNt:RESet / 830
:SBUS<n>:FLEXray:COUNt:SYNC / 831
:SBUS<n>:FLEXray:COUNt:TOTal / 832
:SBUS<n>:FLEXray:SOURce / 833
:SBUS<n>:FLEXray:TRIGger / 834
:SBUS<n>:FLEXray:TRIGger:ERRor:TYPE / 835
:SBUS<n>:FLEXray:TRIGger:EVENT:AUToset / 836
:SBUS<n>:FLEXray:TRIGger:EVENT:BSS:ID / 837
:SBUS<n>:FLEXray:TRIGger:EVENT:TYPE / 838
:SBUS<n>:FLEXray:TRIGger:FRAMe:CCBase / 839
:SBUS<n>:FLEXray:TRIGger:FRAMe:CCRepetition / 840
:SBUS<n>:FLEXray:TRIGger:FRAMe:ID / 841
:SBUS<n>:FLEXray:TRIGger:FRAMe:TYPE / 842
:SBUS<n>:I2S Commands / 843
:SBUS<n>:I2S:ALIGNment / 845
:SBUS<n>:I2S:BASE / 846
:SBUS<n>:I2S:CLOCK:SLOPe / 847
:SBUS<n>:I2S:RWIDth / 848
:SBUS<n>:I2S:SOURce:CLOCK / 849
:SBUS<n>:I2S:SOURce:DATA / 850
:SBUS<n>:I2S:SOURce:WSElect / 851
:SBUS<n>:I2S:TRIGger / 852
:SBUS<n>:I2S:TRIGger:AUDio / 854
:SBUS<n>:I2S:TRIGger:PATTern:DATA / 855
:SBUS<n>:I2S:TRIGger:PATTern:FORMat / 857
:SBUS<n>:I2S:TRIGger:RANGe / 858
:SBUS<n>:I2S:TWIDth / 860
:SBUS<n>:I2S:WSLow / 861
:SBUS<n>:IIC Commands / 862
:SBUS<n>:IIC:ASIZe / 863
:SBUS<n>:IIC[:SOURce]:CLOCK / 864
:SBUS<n>:IIC[:SOURce]:DATA / 865
:SBUS<n>:IIC:TRIGger:PATTern:ADDReSS / 866
:SBUS<n>:IIC:TRIGger:PATTern:DATA / 867
:SBUS<n>:IIC:TRIGger:PATTern:DATA2 / 868
:SBUS<n>:IIC:TRIGger:QUALifier / 869
:SBUS<n>:IIC:TRIGger[:TYPE] / 870

```

- :SBUS<n>:LIN Commands / 872
 - :SBUS<n>:LIN:DISPlay / 874
 - :SBUS<n>:LIN:PARity / 875
 - :SBUS<n>:LIN:SAMPlepoint / 876
 - :SBUS<n>:LIN:SIGNal:BAUDrate / 877
 - :SBUS<n>:LIN:SOURce / 878
 - :SBUS<n>:LIN:STANdard / 879
 - :SBUS<n>:LIN:SYNCbreak / 880
 - :SBUS<n>:LIN:TRIGger / 881
 - :SBUS<n>:LIN:TRIGger:ID / 882
 - :SBUS<n>:LIN:TRIGger:PATtern:DATA / 883
 - :SBUS<n>:LIN:TRIGger:PATtern:DATA:LENGth / 885
 - :SBUS<n>:LIN:TRIGger:PATtern:FORMat / 886
 - :SBUS<n>:LIN:TRIGger:SYMBolic:FRAMe / 887
 - :SBUS<n>:LIN:TRIGger:SYMBolic:SIGNal / 888
 - :SBUS<n>:LIN:TRIGger:SYMBolic:VALue / 889
- :SBUS<n>:M1553 Commands / 890
 - :SBUS<n>:M1553:AUTOsetuP / 891
 - :SBUS<n>:M1553:BASE / 892
 - :SBUS<n>:M1553:SOURce / 893
 - :SBUS<n>:M1553:TRIGger:PATtern:DATA / 894
 - :SBUS<n>:M1553:TRIGger:RTA / 895
 - :SBUS<n>:M1553:TRIGger:TYPE / 896
- :SBUS<n>:SENT Commands / 897
 - :SBUS<n>:SENT:CLOCK / 900
 - :SBUS<n>:SENT:CRC / 901
 - :SBUS<n>:SENT:DISPlay / 902
 - :SBUS<n>:SENT:FORMat / 904
 - :SBUS<n>:SENT:IDLE / 906
 - :SBUS<n>:SENT:LENGth / 907
 - :SBUS<n>:SENT:PPULse / 908
 - :SBUS<n>:SENT:SIGNal<s>:DISPlay / 909
 - :SBUS<n>:SENT:SIGNal<s>:LENGth / 910
 - :SBUS<n>:SENT:SIGNal<s>:MULTIplier / 912
 - :SBUS<n>:SENT:SIGNal<s>:OFFSet / 913
 - :SBUS<n>:SENT:SIGNal<s>:ORDer / 914
 - :SBUS<n>:SENT:SIGNal<s>:STARt / 916
 - :SBUS<n>:SENT:SOURce / 918
 - :SBUS<n>:SENT:TOLerance / 920
 - :SBUS<n>:SENT:TRIGger / 921
 - :SBUS<n>:SENT:TRIGger:FAST:DATA / 923

- :SBUS<n>:SENT:TRIGger:SLOW:DATA / 924
- :SBUS<n>:SENT:TRIGger:SLOW:ID / 926
- :SBUS<n>:SENT:TRIGger:SLOW:ILENght / 928
- :SBUS<n>:SENT:TRIGger:TOLerance / 929
- :SBUS<n>:SPI Commands / 930
 - :SBUS<n>:SPI:BITOrder / 932
 - :SBUS<n>:SPI:CLOCK:SLOPe / 933
 - :SBUS<n>:SPI:CLOCK:TIMeout / 934
 - :SBUS<n>:SPI:FRAMing / 935
 - :SBUS<n>:SPI:SOURce:CLOCK / 936
 - :SBUS<n>:SPI:SOURce:FRAME / 937
 - :SBUS<n>:SPI:SOURce:MISO / 938
 - :SBUS<n>:SPI:SOURce:MOSI / 939
 - :SBUS<n>:SPI:TRIGger:PATTern:MISO:DATA / 940
 - :SBUS<n>:SPI:TRIGger:PATTern:MISO:WIDTh / 941
 - :SBUS<n>:SPI:TRIGger:PATTern:MOSI:DATA / 942
 - :SBUS<n>:SPI:TRIGger:PATTern:MOSI:WIDTh / 943
 - :SBUS<n>:SPI:TRIGger:TYPE / 944
 - :SBUS<n>:SPI:WIDTh / 945
- :SBUS<n>:UART Commands / 946
 - :SBUS<n>:UART:BASE / 949
 - :SBUS<n>:UART:BAUDrate / 950
 - :SBUS<n>:UART:BITOrder / 951
 - :SBUS<n>:UART:COUNT:ERRor / 952
 - :SBUS<n>:UART:COUNT:RESet / 953
 - :SBUS<n>:UART:COUNT:RXFRames / 954
 - :SBUS<n>:UART:COUNT:TXFRames / 955
 - :SBUS<n>:UART:FRAMing / 956
 - :SBUS<n>:UART:PARity / 957
 - :SBUS<n>:UART:POLarity / 958
 - :SBUS<n>:UART:SOURce:RX / 959
 - :SBUS<n>:UART:SOURce:TX / 960
 - :SBUS<n>:UART:TRIGger:BASE / 961
 - :SBUS<n>:UART:TRIGger:BURSt / 962
 - :SBUS<n>:UART:TRIGger:DATA / 963
 - :SBUS<n>:UART:TRIGger:IDLE / 964
 - :SBUS<n>:UART:TRIGger:QUALifier / 965
 - :SBUS<n>:UART:TRIGger:TYPE / 966
 - :SBUS<n>:UART:WIDTh / 967

30 :SEARCh Commands

General :SEARCh Commands /	970
:SEARCh:COUNT /	971
:SEARCh:EVENT /	972
:SEARCh:MODE /	973
:SEARCh:STATe /	974
:SEARCh:EDGE Commands /	975
:SEARCh:EDGE:SLOPe /	976
:SEARCh:EDGE:SOURce /	977
:SEARCh:GLITCh Commands /	978
:SEARCh:GLITCh:GREaterthan /	979
:SEARCh:GLITCh:LESSthan /	980
:SEARCh:GLITCh:POLarity /	981
:SEARCh:GLITCh:QUALifier /	982
:SEARCh:GLITCh:RANGe /	983
:SEARCh:GLITCh:SOURce /	984
:SEARCh:PEAK Commands /	985
:SEARCh:PEAK:EXCursion /	986
:SEARCh:PEAK:NPEaks /	987
:SEARCh:PEAK:SOURce /	988
:SEARCh:PEAK:THReshold /	989
:SEARCh:RUNT Commands /	990
:SEARCh:RUNT:POLarity /	991
:SEARCh:RUNT:QUALifier /	992
:SEARCh:RUNT:SOURce /	993
:SEARCh:RUNT:TIME /	994
:SEARCh:TRANSition Commands /	995
:SEARCh:TRANSition:QUALifier /	996
:SEARCh:TRANSition:SLOPe /	997
:SEARCh:TRANSition:SOURce /	998
:SEARCh:TRANSition:TIME /	999
:SEARCh:SERial:A429 Commands /	1000
:SEARCh:SERial:A429:LABel /	1001
:SEARCh:SERial:A429:MODE /	1002
:SEARCh:SERial:A429:PATTern:DATA /	1003
:SEARCh:SERial:A429:PATTern:SDI /	1004
:SEARCh:SERial:A429:PATTern:SSM /	1005
:SEARCh:SERial:CAN Commands /	1006

```

:SEARch:SERial:CAN:MODE / 1007
:SEARch:SERial:CAN:PATtern:DATA / 1009
:SEARch:SERial:CAN:PATtern:DATA:LENGth / 1010
:SEARch:SERial:CAN:PATtern:ID / 1011
:SEARch:SERial:CAN:PATtern:ID:MODE / 1012
:SEARch:SERial:CAN:SYMBolic:MESSAge / 1013
:SEARch:SERial:CAN:SYMBolic:SIGNal / 1014
:SEARch:SERial:CAN:SYMBolic:VALue / 1015

:SEARch:SERial:FLEXray Commands / 1016
:SEARch:SERial:FLEXray:CYCLe / 1017
:SEARch:SERial:FLEXray:DATA / 1018
:SEARch:SERial:FLEXray:DATA:LENGth / 1019
:SEARch:SERial:FLEXray:FRAMe / 1020
:SEARch:SERial:FLEXray:MODE / 1021

:SEARch:SERial:I2S Commands / 1022
:SEARch:SERial:I2S:AUDio / 1023
:SEARch:SERial:I2S:MODE / 1024
:SEARch:SERial:I2S:PATtern:DATA / 1025
:SEARch:SERial:I2S:PATtern:FORMat / 1026
:SEARch:SERial:I2S:RANGe / 1027

:SEARch:SERial:IIC Commands / 1028
:SEARch:SERial:IIC:MODE / 1029
:SEARch:SERial:IIC:PATtern:ADDResS / 1031
:SEARch:SERial:IIC:PATtern:DATA / 1032
:SEARch:SERial:IIC:PATtern:DATA2 / 1033
:SEARch:SERial:IIC:QUALifier / 1034

:SEARch:SERial:LIN Commands / 1035
:SEARch:SERial:LIN:ID / 1036
:SEARch:SERial:LIN:MODE / 1037
:SEARch:SERial:LIN:PATtern:DATA / 1038
:SEARch:SERial:LIN:PATtern:DATA:LENGth / 1039
:SEARch:SERial:LIN:PATtern:FORMat / 1040
:SEARch:SERial:LIN:SYMBolic:FRAMe / 1041
:SEARch:SERial:LIN:SYMBolic:SIGNal / 1042
:SEARch:SERial:LIN:SYMBolic:VALue / 1043

:SEARch:SERial:M1553 Commands / 1044
:SEARch:SERial:M1553:MODE / 1045
:SEARch:SERial:M1553:PATtern:DATA / 1046
:SEARch:SERial:M1553:RTA / 1047

```

- :SEARch:SERIal:SENT Commands / 1048
 - :SEARch:SERIal:SENT:FAST:DATA / 1049
 - :SEARch:SERIal:SENT:MODE / 1050
 - :SEARch:SERIal:SENT:SLOW:DATA / 1051
 - :SEARch:SERIal:SENT:SLOW:ID / 1052
- :SEARch:SERIal:SPI Commands / 1053
 - :SEARch:SERIal:SPI:MODE / 1054
 - :SEARch:SERIal:SPI:PATtern:DATA / 1055
 - :SEARch:SERIal:SPI:PATtern:WIDTh / 1056
- :SEARch:SERIal:UART Commands / 1057
 - :SEARch:SERIal:UART:DATA / 1058
 - :SEARch:SERIal:UART:MODE / 1059
 - :SEARch:SERIal:UART:QUALifier / 1060

31 :SYSTem Commands

- :SYSTem:DATE / 1063
- :SYSTem:DSP / 1064
- :SYSTem:ERRor / 1065
- :SYSTem:LOCK / 1066
- :SYSTem:PERSONa[:MANufacturer] / 1067
- :SYSTem:PERSONa[:MANufacturer]:DEFault / 1068
- :SYSTem:PRESet / 1069
- :SYSTem:PROTection:LOCK / 1072
- :SYSTem:RLOGger / 1073
- :SYSTem:RLOGger:DESTination / 1074
- :SYSTem:RLOGger:DISPlay / 1075
- :SYSTem:RLOGger:FNAME / 1076
- :SYSTem:RLOGger:STATe / 1077
- :SYSTem:RLOGger:TRANSPARENT / 1078
- :SYSTem:RLOGger:WMODE / 1079
- :SYSTem:SETup / 1080
- :SYSTem:TIME / 1082
- :SYSTem:TOUCh / 1083

32 :TIMebase Commands

- :TIMebase:MODE / 1087
- :TIMebase:POSition / 1088
- :TIMebase:RANGe / 1089
- :TIMebase:REFerence / 1090
- :TIMebase:REFerence:LOCation / 1091
- :TIMebase:SCALE / 1092

:TIMebase:VERNier / 1093
:TIMebase:WINDow:POSition / 1094
:TIMebase:WINDow:RANGe / 1095
:TIMebase:WINDow:SCALe / 1096

33 :TRIGger Commands

General :TRIGger Commands / 1099
:TRIGger:FORCe / 1100
:TRIGger:HFReject / 1101
:TRIGger:HOLDoff / 1102
:TRIGger:LEVel:ASETup / 1103
:TRIGger:LEVel:HIGH / 1104
:TRIGger:LEVel:LOW / 1105
:TRIGger:MODE / 1106
:TRIGger:NREJect / 1107
:TRIGger:SWEep / 1108

:TRIGger:DELay Commands / 1109
:TRIGger:DELay:ARM:SLOPe / 1110
:TRIGger:DELay:ARM:SOURce / 1111
:TRIGger:DELay:TDELay:TIME / 1112
:TRIGger:DELay:TRIGger:COUNt / 1113
:TRIGger:DELay:TRIGger:SLOPe / 1114
:TRIGger:DELay:TRIGger:SOURce / 1115

:TRIGger:EBURst Commands / 1116
:TRIGger:EBURst:COUNt / 1117
:TRIGger:EBURst:IDLE / 1118
:TRIGger:EBURst:SLOPe / 1119
:TRIGger:EBURst:SOURce / 1120

:TRIGger[:EDGE] Commands / 1121
:TRIGger[:EDGE]:COUPling / 1122
:TRIGger[:EDGE]:LEVel / 1123
:TRIGger[:EDGE]:REJect / 1124
:TRIGger[:EDGE]:SLOPe / 1125
:TRIGger[:EDGE]:SOURce / 1126

:TRIGger:GLITch Commands / 1127
:TRIGger:GLITch:GREaterthan / 1129
:TRIGger:GLITch:LESSthan / 1130
:TRIGger:GLITch:LEVel / 1131
:TRIGger:GLITch:POLarity / 1132
:TRIGger:GLITch:QUALifier / 1133

- :TRIGger:GLITch:RANGe / 1134
- :TRIGger:GLITch:SOURce / 1135
- :TRIGger:NFC Commands / 1136
 - :TRIGger:NFC:AEVEnt / 1137
 - :TRIGger:NFC:ATTime / 1138
 - :TRIGger:NFC:SOURce / 1139
 - :TRIGger:NFC:STANdard / 1140
 - :TRIGger:NFC:TEVEnt / 1141
 - :TRIGger:NFC:TIMeout / 1143
 - :TRIGger:NFC:TIMeout:ENABle / 1144
 - :TRIGger:NFC:TIMeout:TIME / 1145
- :TRIGger:OR Commands / 1146
 - :TRIGger:OR / 1147
- :TRIGger:PATTern Commands / 1148
 - :TRIGger:PATTern / 1149
 - :TRIGger:PATTern:FORMat / 1151
 - :TRIGger:PATTern:GREaterthan / 1152
 - :TRIGger:PATTern:LESSthan / 1153
 - :TRIGger:PATTern:QUALifier / 1154
 - :TRIGger:PATTern:RANGe / 1155
- :TRIGger:RUNT Commands / 1156
 - :TRIGger:RUNT:POLarity / 1157
 - :TRIGger:RUNT:QUALifier / 1158
 - :TRIGger:RUNT:SOURce / 1159
 - :TRIGger:RUNT:TIME / 1160
- :TRIGger:SHOLd Commands / 1161
 - :TRIGger:SHOLd:SLOPe / 1162
 - :TRIGger:SHOLd:SOURce:CLOCK / 1163
 - :TRIGger:SHOLd:SOURce:DATA / 1164
 - :TRIGger:SHOLd:TIME:HOLD / 1165
 - :TRIGger:SHOLd:TIME:SETup / 1166
- :TRIGger:TRANsition Commands / 1167
 - :TRIGger:TRANsition:QUALifier / 1168
 - :TRIGger:TRANsition:SLOPe / 1169
 - :TRIGger:TRANsition:SOURce / 1170
 - :TRIGger:TRANsition:TIME / 1171
- :TRIGger:TV Commands / 1172
 - :TRIGger:TV:LINE / 1173
 - :TRIGger:TV:MODE / 1174

- :TRIGger:TV:POLarity / 1175
- :TRIGger:TV:SOURce / 1176
- :TRIGger:TV:STANdard / 1177
- :TRIGger:TV:UDTV:ENUMber / 1178
- :TRIGger:TV:UDTV:HSYNc / 1179
- :TRIGger:TV:UDTV:HTIME / 1180
- :TRIGger:TV:UDTV:PGTHan / 1181
- :TRIGger:USB Commands / 1182
 - :TRIGger:USB:SOURce:DMINus / 1183
 - :TRIGger:USB:SOURce:DPLus / 1184
 - :TRIGger:USB:SPEEd / 1185
 - :TRIGger:USB:TRIGger / 1186
- :TRIGger:ZONE Commands / 1187
 - :TRIGger:ZONE:SOURce / 1188
 - :TRIGger:ZONE:STATe / 1189
 - :TRIGger:ZONE<n>:MODE / 1190
 - :TRIGger:ZONE<n>:PLACement / 1191
 - :TRIGger:ZONE<n>:VALidity / 1192
 - :TRIGger:ZONE<n>:STATe / 1193

34 :WAVeform Commands

- :WAVeform:BYTeorder / 1203
- :WAVeform:COUNT / 1204
- :WAVeform:DATA / 1205
- :WAVeform:FORMat / 1207
- :WAVeform:POINts / 1208
- :WAVeform:POINts:MODE / 1210
- :WAVeform:PREamble / 1212
- :WAVeform:SEGmented:COUNT / 1215
- :WAVeform:SEGmented:TTAG / 1216
- :WAVeform:SOURce / 1217
- :WAVeform:SOURce:SUBSource / 1221
- :WAVeform:TYPE / 1222
- :WAVeform:UNSigned / 1223
- :WAVeform:VIEW / 1224
- :WAVeform:XINCrement / 1225
- :WAVeform:XORigin / 1226
- :WAVeform:XREFerence / 1227
- :WAVeform:YINCrement / 1228
- :WAVeform:YORigin / 1229
- :WAVeform:YREFerence / 1230

35 :WGEN<w> Commands

:WGEN<w>:ARbitrary:BYTeorder / 1235
:WGEN<w>:ARbitrary:DATA / 1236
:WGEN<w>:ARbitrary:DATA:ATTRibute:POINts / 1237
:WGEN<w>:ARbitrary:DATA:CLEar / 1238
:WGEN<w>:ARbitrary:DATA:DAC / 1239
:WGEN<w>:ARbitrary:INTErpolate / 1240
:WGEN<w>:ARbitrary:STORe / 1241
:WGEN<w>:FREQuency / 1242
:WGEN<w>:FUNction / 1243
:WGEN<w>:FUNction:PULSe:WIDTh / 1247
:WGEN<w>:FUNction:RAMP:SYMMetry / 1248
:WGEN<w>:FUNction:SQUare:DCYCLE / 1249
:WGEN<w>:MODulation:AM:DEPTH / 1250
:WGEN<w>:MODulation:AM:FREQuency / 1251
:WGEN<w>:MODulation:FM:DEVIation / 1252
:WGEN<w>:MODulation:FM:FREQuency / 1253
:WGEN<w>:MODulation:FSKey:FREQuency / 1254
:WGEN<w>:MODulation:FSKey:RATE / 1255
:WGEN<w>:MODulation:FUNCTion / 1256
:WGEN<w>:MODulation:FUNCTion:RAMP:SYMMetry / 1257
:WGEN<w>:MODulation:NOISe / 1258
:WGEN<w>:MODulation:STATe / 1259
:WGEN<w>:MODulation:TYPE / 1260
:WGEN<w>:OUTPut / 1262
:WGEN<w>:OUTPut:LOAD / 1263
:WGEN<w>:OUTPut:MODE / 1264
:WGEN<w>:OUTPut:POLarity / 1265
:WGEN<w>:OUTPut:SINGLE / 1266
:WGEN<w>:PERiod / 1267
:WGEN<w>:RST / 1268
:WGEN<w>:VOLTage / 1269
:WGEN<w>:VOLTage:HIGh / 1270
:WGEN<w>:VOLTage:LOW / 1271
:WGEN<w>:VOLTage:OFFSet / 1272

36 :WMEMory<r> Commands

:WMEMory<r>:CLEar / 1275
:WMEMory<r>:DISPlay / 1276
:WMEMory<r>:LABel / 1277
:WMEMory<r>:SAVE / 1278

:WMEMemory<r>:SKEW / 1279
:WMEMemory<r>:YOffset / 1280
:WMEMemory<r>:YRange / 1281
:WMEMemory<r>:YScale / 1282

37 Obsolete and Discontinued Commands

:Channel:ACTivity / 1290
:Channel:LABel / 1291
:Channel:THReshold / 1292
:Channel2:SKEW / 1293
:Channel<n>:INPut / 1294
:Channel<n>:PMODE / 1295
:DISPlay:CONNect / 1296
:DISPlay:ORDer / 1297
:ERASe / 1298
:EXTernal:PMODE / 1299
:FUNction:GOFT:OPERation / 1300
:FUNction:GOFT:SOURce1 / 1301
:FUNction:GOFT:SOURce2 / 1302
:FUNction:SOURce / 1303
:FUNction:VIEW / 1304
:HARDcopy:DESTination / 1305
:HARDcopy:FILEname / 1306
:HARDcopy:GRAYscale / 1307
:HARDcopy:IGColors / 1308
:HARDcopy:PDRiver / 1309
:MEASure:LOWer / 1310
:MEASure:SCRatch / 1311
:MEASure:TDELta / 1312
:MEASure:THResholds / 1313
:MEASure:TMAX / 1314
:MEASure:TMIN / 1315
:MEASure:TSTArt / 1316
:MEASure:TSTOp / 1317
:MEASure:TVOLt / 1318
:MEASure:UPPer / 1319
:MEASure:VDELta / 1320
:MEASure:VSTArt / 1321
:MEASure:VSTOp / 1322
:MTEST:AMASK:{SAVE | STORE} / 1323
:MTEST:AVERAge / 1324

:MTEST:AVERage:COUNT / 1325
 :MTEST:LOAD / 1326
 :MTEST:RUMode / 1327
 :MTEST:RUMode:SOFailure / 1328
 :MTEST:{START|STOP} / 1329
 :MTEST:TRIGger:SOURce / 1330
 :PRINT? / 1331
 :SAVE:IMAGe:AREA / 1333
 :SBUS<n>:LIN:SIGNal:DEFinition / 1334
 :SBUS<n>:SPI:SOURce:DATA / 1335
 :SYSTem:MENU / 1336
 :TIMEbase:DELay / 1337
 :TRIGger:THReshold / 1338
 :TRIGger:TV:TVMode / 1339

38 Error Messages

39 Status Reporting

Status Reporting Data Structures / 1351
 Status Byte Register (STB) / 1354
 Service Request Enable Register (SRE) / 1356
 Trigger Event Register (TER) / 1357
 Output Queue / 1358
 Message Queue / 1359
 (Standard) Event Status Register (ESR) / 1360
 (Standard) Event Status Enable Register (ESE) / 1361
 Error Queue / 1362
 Operation Status Event Register (:OPERRegister[:EVENT]) / 1363
 Operation Status Condition Register (:OPERRegister:CONDition) / 1364
 Arm Event Register (AER) / 1365
 Overload Event Register (:OVLRegister) / 1366
 Hardware Event Event Register (:HWERRegister[:EVENT]) / 1367
 Hardware Event Condition Register (:HWERRegister:CONDition) / 1368
 Mask Test Event Event Register (:MTERegister[:EVENT]) / 1369
 Clearing Registers and Queues / 1370
 Status Reporting Decision Chart / 1371

40 Synchronizing Acquisitions

- Synchronization in the Programming Flow / 1374
 - Set Up the Oscilloscope / 1374
 - Acquire a Waveform / 1374
 - Retrieve Results / 1374
- Blocking Synchronization / 1375
- Polling Synchronization With Timeout / 1376
- Synchronizing with a Single-Shot Device Under Test (DUT) / 1378
- Synchronization with an Averaging Acquisition / 1380

41 More About Oscilloscope Commands

- Command Classifications / 1384
 - Core Commands / 1384
 - Non-Core Commands / 1384
 - Obsolete Commands / 1384
- Valid Command/Query Strings / 1385
 - Program Message Syntax / 1385
 - Duplicate Mnemonics / 1389
 - Tree Traversal Rules and Multiple Commands / 1389
- Query Return Values / 1391
- All Oscilloscope Commands Are Sequential / 1392

42 Programming Examples

- VISA COM Examples / 1394
 - VISA COM Example in Visual Basic / 1394
 - VISA COM Example in C# / 1403
 - VISA COM Example in Visual Basic .NET / 1412
 - VISA COM Example in Python / 1420
- VISA Examples / 1427
 - VISA Example in C / 1427
 - VISA Example in Visual Basic / 1436
 - VISA Example in C# / 1446
 - VISA Example in Visual Basic .NET / 1457
 - VISA Example in Python (PyVISA 1.5 and older) / 1467
 - VISA Example in Python (PyVISA 1.6 and newer) / 1473

- SICL Examples / 1480
 - SICL Example in C / 1480
 - SICL Example in Visual Basic / 1489
- SCPI.NET Examples / 1500
 - SCPI.NET Example in C# / 1500
 - SCPI.NET Example in Visual Basic .NET / 1506
 - SCPI.NET Example in IronPython / 1512

Index

1 What's New

What's New in Version 4.08 / 38

What's New in Version 4.07 / 41

What's New in Version 4.06 / 43

What's New in Version 4.05 / 44

Version 4.00 at Introduction / 46

Command Differences From 4000 X-Series Oscilloscopes / 47

What's New in Version 4.08

New features in version 4.08 of the InfiniiVision 3000T X-Series oscilloscope software are:

- CXPI (Clock Extension Peripheral Interface) serial decode and triggering option.
- Power measurements application updates.
- Added FFTPhase math function.
- Custom timebase reference—as a percent, from the left edge to the right edge of the graticule.
- Added remote commands for specifying N2820A high-sensitivity current probe zoom-in channel and N2825A user-defined R-sense head resistor value.

More detailed descriptions of the new and changed commands appear below.

New Commands

Command	Description
:CHANnel<n>:PROBe:RSENse (see page 303)	When the N2820A high-sensitivity current probe is used with the N2825A user-defined R-sense head, this command specifies the value of the R-sense resistor that is being probed in the device under test (DUT).
:CHANnel<n>:PROBe:ZOOM (see page 306)	When the N2820A high-sensitivity current probe is used with both the Primary and Secondary cables, this command specifies whether this cable will have the Zoom In waveform (ON) or the Zoom Out waveform (OFF).
:FUNctIon<m>[:FFT]:PHASe:RE FERENCE (see page 408)	Sets the reference point for calculating the FFT Phase function to either the trigger point or beginning of the displayed waveform.
:POWer:CLResponse? (see page 628)	Returns the Control Loop Response (Bode) power analysis settings.
:POWer:CLResponse:DATA? (see page 630)	Returns data from the Control Loop Response (Bode) power analysis.
:POWer:CLResponse:FREQUen cy:MODE (see page 631)	Specifies whether the analysis should be performed by sweeping through a range of frequencies (SWEep) or at a single frequency (SINGLE).
:POWer:CLResponse:PPDecade (see page 634)	Selects the number of frequency test points per decade (in the log scale).
:POWer:CLResponse:SOURce:I NPut (see page 635)	Selects the oscilloscope channel that is probing the power supply input.
:POWer:CLResponse:SOURce: OUTPut (see page 636)	Selects the oscilloscope channel that is probing the power supply output.
:POWer:CLResponse:WGEN:LO AD (see page 637)	Sets the waveform generator expected output load impedance.

Command	Description
:POWer:CLResponse:WGEN:VOLTagE (see page 638)	Sets the waveform generator output amplitude(s).
:POWer:CLResponse:WGEN:VOLTagE:PROFile (see page 639)	Enables or disables the ability to set initial waveform generator ramp amplitudes for each frequency range.
:POWer:ITYPe (see page 659)	Specifies the type of input power that is being converted to the output.
:POWer:ONOFF:THResholds (see page 667)	Specifies the input and output thresholds used in the Turn On/Turn Off analysis.
:POWer:PSRR? (see page 669)	Returns the Power Supply Rejection Ratio (PSRR) power analysis settings.
:POWer:PSRR:DATA? (see page 671)	Returns data from the Power Supply Rejection Ratio (PSRR) power analysis.
:POWer:PSRR:FREQuency:MODe (see page 674)	Specifies whether the analysis should be performed by sweeping through a range of frequencies (SWEep) or at a single frequency (SINgLE).
:POWer:PSRR:PPDecade (see page 675)	Selects the number of frequency test points per decade (in the log scale).
:POWer:PSRR:SOURce:INPut (see page 676)	Selects the oscilloscope channel that is probing the power supply input.
:POWer:PSRR:SOURce:OUTPut (see page 677)	Selects the oscilloscope channel that is probing the power supply output.
:POWer:PSRR:WGEN:LOAD (see page 678)	Sets the waveform generator expected output load impedance.
:POWer:PSRR:WGEN:VOLTagE (see page 679)	Sets the waveform generator output amplitude(s).
:POWer:PSRR:WGEN:VOLTagE:PROFile (see page 680)	Enables or disables the ability to set initial waveform generator ramp amplitudes for each frequency range.
:SBUS<n>:CXPI Commands (see page 807)	Commands for using the CXPI triggering and serial decode feature.
:TIMebase:REFeRence:LOCation (see page 1091)	When the :TIMebase:REFeRence is set to CUSTom, this command lets you place the time reference location at a percent of the graticule width (where 0.0 is the left edge and 1.0 is the right edge).

Changed Commands

Command	Differences
:CHANnel<n>:PROBe (see page 299)	The probe attenuation factor can now be set from 0.001:1 to 10000:1.
:FUNction<m>[:FFT]:VTYPE (see page 410)	With the FFTPhase operation, you can select vertical units in DEGRees or RADians.
:FUNction<m>:OPERation (see page 418)	The FFTPhase operation is added.
:FUNction<m>:SOURce1 (see page 426)	Reference waveforms can now be specified as source 1.
:FUNction<m>:SOURce2 (see page 428)	Reference waveforms can now be specified as source 2.
:POWER:HARMONics:LINE (see page 648)	The AUTO frequency option is added. This option automatically determines the frequency of the Current waveform.
:SBUS<n>:LIN:STANdard (see page 879)	The LIN13NLC option is added for selecting LIN 1.3 (no length control).
:SBUS<n>:MODE (see page 759)	The CXPI mode is now available with the DSOXT3CXPI CXPI serial decode and triggering license.
:TIMEbase:REFerence (see page 1090)	The CUSTom option is added for placing the time reference location at a percent of the graticule width.

Discontinued Commands

Discontinued Command	Current Command Equivalent	Comments
:POWER:CLResponse:VIEW	none	Because the plot now appears in its own dialog box and contains both gain and phase plots, there is no longer a need to select one or the other.
:POWER:CLResponse:YMAXimum	none	Specifying the plot's initial vertical scale maximum value is no longer necessary because the plot now appears in its own dialog box and is autoscaled.
:POWER:CLResponse:YMINimum	none	Specifying the plot's initial vertical scale minimum value is no longer necessary because the plot now appears in its own dialog box and is autoscaled.
:POWER:PSRR:RMAXimum	none	Specifying the plot's initial vertical scale value is no longer necessary because the plot now appears in its own dialog box and is autoscaled.

What's New in Version 4.07

New features in version 4.07 of the InfiniiVision 3000T X-Series oscilloscope software are:

- Remote commands for remote command logging.
- Near Field Communication (NFC) trigger mode.

More detailed descriptions of the new and changed commands appear below.

New Commands

Command	Description
:FFT:GATE (see page 381)	Specifies whether the FFT is performed on the Main time base window or the Zoom window when the zoomed time base is displayed.
:FUNCTION<m>[:FFT]:GATE (see page 407)	Specifies whether the FFT is performed on the Main time base window or the Zoom window when the zoomed time base is displayed.
:MARKer:X1:DISPlay (see page 458)	Specifies whether the X1 cursor is displayed.
:MARKer:X2:DISPlay (see page 461)	Specifies whether the X2 cursor is displayed.
:MARKer:Y1:DISPlay (see page 467)	Specifies whether the Y1 cursor is displayed.
:MARKer:Y2:DISPlay (see page 469)	Specifies whether the Y2 cursor is displayed.
:SYSTem:RLOGger (see page 1073)	Enables or disables remote command logging, optionally specifying the log file name and write mode.
:SYSTem:RLOGger:DESTination (see page 1074)	Specifies whether remote commands are logged to a text file (on a connected USB storage device), logged to the screen, or both.
:SYSTem:RLOGger:DISPlay (see page 1075)	Enables or disables the screen display of logged remote commands and their return values (if applicable).
:SYSTem:RLOGger:FNAME (see page 1076)	Specifies the remote command log file name.
:SYSTem:RLOGger:STATe (see page 1077)	Enables or disables remote command logging.
:SYSTem:RLOGger:TRANsparenT (see page 1078)	Specifies whether the screen display background for remote command logging is transparent or solid.
:SYSTem:RLOGger:WMODe (see page 1079)	Specifies the remote command logging write mode (either CREate or APPend).
:TRIGger:NFC Commands (see page 1136)	Commands for setting up the Near Field Communication (NFC) trigger mode.

Changed
Commands

Command	Differences
:CALibrate:OUTPut (see page 281)	The NFC option becomes available in the Near Field Communication (NFC) trigger mode when the ATRigger (Arm & Trigger) trigger event is selected.
:FUNction<m>:OPERation (see page 418)	The MAXimum, MINimum, and PEAK operations are added.
:TRIGger:MODE (see page 1106)	The NFC option is now available for setting the Near Field Communication (NFC) trigger mode. See “:TRIGger:NFC Commands” on page 1136.

What's New in Version 4.06

New features in version 4.06 of the InfiniiVision 3000T X-Series oscilloscope software are:

- The Control Loop Response (Bode) power analysis now lets you select a phase plot as well as a gain plot.
- The ISO standard for CAN FD is now supported.
- Up to 10 annotations are supported.

More detailed descriptions of the new and changed commands appear below.

New Commands

Command	Description
:POWER:CLResponse:VIEW	When the Control Loop Response (Bode) power analysis is selected, this command selects whether to display a gain or phase plot.
:SBUS<n>:CAN:FDStandard (see page 788)	Lets you pick the standard that will be used when decoding or triggering on FD frames, ISO, or non-ISO.

Changed Commands

Command	Differences
:DISPlay:ANNotation<n> (see page 344)	You can now define up to 10 annotations.
:DISPlay:ANNotation<n>:BACK ground (see page 345)	
:DISPlay:ANNotation<n>:COLor (see page 346)	
:DISPlay:ANNotation<n>:TEXT (see page 347)	
:DISPlay:ANNotation<n>:X1Pos ition (see page 348)	
:DISPlay:ANNotation<n>:Y1Pos ition (see page 349)	
:SBUS<n>:CAN:TRIGger (see page 794)	Has some description changes related to the CAN FD ISO support changes.

What's New in Version 4.05

New features in version 4.05 of the InfiniiVision 3000T X-Series oscilloscope software are:

- Being able to load LIN symbolic data from an LDF (*.ldf) file into the oscilloscope, display it in the decode, and use it to set up triggers and protocol decode searches.

More detailed descriptions of the new and changed commands appear below.

New Commands

Command	Description
:POWer:CLResponse:APPLY (see page 629)	Performs the Control Loop Response (Bode) power analysis.
:POWer:CLResponse:FREQuency:START (see page 632)	Sets the sweep start frequency value.
:POWer:CLResponse:FREQuency:STOP (see page 633)	Sets the sweep stop frequency value.
:POWer:CLResponse:YMAXimum	Specifies the Bode plot's initial vertical scale maximum value.
:POWer:CLResponse:YMINimum	Specifies the Bode plot's initial vertical scale minimum value.
:POWer:HARMonics:RPOWer (see page 650)	When Class D is selected as the current harmonics analysis standard, this command specifies whether the Real Power value used for the current-per-watt measurement is measured by the oscilloscope or is defined by the user.
:POWer:HARMonics:RPOWer:USER (see page 651)	When Class D is selected as the current harmonics analysis standard and you have chosen to use a user-defined Real Power value, this command specifies the Real Power value used in the current-per-watt measurement.
:RECall:LDF[:START] (see page 720)	Loads a LIN description file (LDF) into the oscilloscope.
:SBUS<n>:LIN:DISPlay (see page 874)	Specifies whether symbolic values (from a loaded LDF file) or hexadecimal values are displayed in the decode waveform and the Lister window
:SBUS<n>:LIN:TRIGger:SYMBOLic:FRAMe (see page 887)	Specifies the frame to trigger on when LIN symbolic data has been loaded (recalled) into the oscilloscope and the LIN trigger mode is set to FRAMe or FSIGnal.
:SBUS<n>:LIN:TRIGger:SYMBOLic:SIGNal (see page 888)	Specifies signal to trigger on when LIN symbolic data has been loaded (recalled) into the oscilloscope and the LIN trigger mode is set to FSIGnal.

Command	Description
:SBUS<n>:LIN:TRIGger:SYMBOLic:VALue (see page 889)	Specifies signal value to trigger on when LIN symbolic data has been loaded (recalled) into the oscilloscope and the LIN trigger mode is set to FSIGnal.
:SEARCh:SERial:LIN:SYMBOLic:FRAMe (see page 1041)	Specifies the message to search for when LIN symbolic data has been loaded (recalled) into the oscilloscope and the LIN serial search mode is set to FRAME or FSIGnal.
:SEARCh:SERial:LIN:SYMBOLic:SIGNal (see page 1042)	Specifies signal to search for when LIN symbolic data has been loaded (recalled) into the oscilloscope and the LIN serial search mode is set to FSIGnal.
:SEARCh:SERial:LIN:SYMBOLic:VALue (see page 1043)	Specifies signal value to search for when LIN symbolic data has been loaded (recalled) into the oscilloscope and the LIN serial search mode is set to FSIGnal.
:TRIGger:USB Commands (see page 1182)	Resurrected from the 3000 X-Series oscilloscopes, these commands let you trigger on a Start of Packet (SOP), End of Packet (EOP), Reset Complete, Enter Suspend, or Exit Suspend signal on the differential USB data lines. USB Low Speed and Full Speed are supported by this trigger.
:WGEN<w>:OUTPut:MODE (see page 1264)	Specifies whether the defined waveform is output continuously or as a single cycle (single-shot).
:WGEN<w>:OUTPut:SINGle (see page 1266)	When the single-shot output mode is selected, this command causes a single cycle of the defined waveform to be output.

Changed Commands

Command	Differences
:SBUS<n>:LIN:TRIGger (see page 881)	You can now trigger on symbolic frames (with parameter FRAME) or frames and signal values (with parameter FSIGnal).
:SEARCh:SERial:LIN:MODE (see page 1037)	You can now search for symbolic messages (with parameter FRAME) or frames and signal values (with parameter FSIGnal).
:TRIGger:MODE (see page 1106)	The parameter USB is now allowed to permit USB triggering.

Version 4.00 at Introduction

The Keysight InfiniiVision 3000T X-Series oscilloscopes were introduced with version 4.00 of oscilloscope operating software.

The command set is most closely related to the InfiniiVision 4000 X-Series oscilloscopes (and the 3000 X-Series, 7000A/B Series, 6000 Series, and 54620/54640 Series oscilloscopes before them). For more information, see **"Command Differences From 4000 X-Series Oscilloscopes"** on page 47.

Command Differences From 4000 X-Series Oscilloscopes

The Keysight InfiniiVision 3000T X-Series oscilloscopes command set is most closely related to the InfiniiVision 4000 X-Series oscilloscopes (and the 3000 X-Series, 7000A/B Series, 6000 Series, and 54620/54640 Series oscilloscopes before them).

The main differences between the version 4.00 programming command set for the InfiniiVision 3000T X-Series oscilloscopes and the 3.20 programming command set for the InfiniiVision 4000 X-Series oscilloscopes are related to:

- Dedicated FFT function (and selectable math functions – 4000 X-Series oscilloscopes have four selectable math functions).
- SENT serial decode and triggering option.
- Updates to support CAN FD serial decode and triggering.
- Counter feature (when DSOXDMCTR option is licensed).
- New built-in demo signals (with Option EDU license that comes with the N6455A Education Kit).
- One waveform generator output (4000 X-Series oscilloscopes have two waveform generator outputs).
- No 10 MHz REF connector.
- No support for USB 2.0 serial decode, triggering, or signal quality analysis.

More detailed descriptions of the new, changed, obsolete, and discontinued commands appear below.

New Commands

Command	Description
:CHANnel<n>:PROBe:MMODEl (see page 302)	Sets the model number of the supported Tektronix probe.
:COUNter Commands (see page 313)	Commands for controlling the optional DSOXDMCTR counter feature.
:DISPlay:ANNotation<n>:X1Pos ition (see page 348)	Sets the horizontal position of one of the four annotations.
:DISPlay:ANNotation<n>:Y1Pos ition (see page 349)	Sets the horizontal position of one of the four annotations.
:FFT Commands (see page 371)	Commands for using the FFT function feature.
:FUNction<m>:CLEar (see page 402)	When the :FUNction<m>:OPERation is AVERage, MAXHold, or MINHold, this command clears the number of evaluated waveforms.

Command	Description
:FUNction<m>[:FFT]:FREQuency:START (see page 405)	Lets you set the displayed frequency range using start and stop frequency values.
:FUNction<m>[:FFT]:FREQuency:STOP (see page 406)	
:FUNction<m>:SMOoth:POINts (see page 425)	Sets the number of smoothing points for the new SMOoth:FUNction<m>:OPERation.
:MEASure:BRATe (see page 494)	Installs a bit rate measurement on screen or returns the measured value.
:MEASure:RDSon (see page 574)	Installs an RDS(on) power measurement on screen or returns the measured value.
:MEASure:VCESat (see page 579)	Installs a VCE(sat) power measurement on screen or returns the measured value.
:POWer:EFFiciency:TYPE (see page 642)	Specifies the type of power that is being converted from the input to the output.
:SAVE:RESults:[START] (see page 741)	Saves analysis results to a comma-separated values (*.csv) file on a USB storage device.
:SAVE:RESults:FORMat:CURSor (see page 742)	Specifies whether cursor values will be included when analysis results are saved.
:SAVE:RESults:FORMat:MASK (see page 743)	Specifies whether mask statistics will be included when analysis results are saved.
:SAVE:RESults:FORMat:MEASurement (see page 744)	Specifies whether measurement results will be included when analysis results are saved.
:SAVE:RESults:FORMat:SEARch (see page 745)	Specifies whether found search event times will be included when analysis results are saved.
:SAVE:RESults:FORMat:SEGmented (see page 746)	Specifies whether segmented memory acquisition times will be included when analysis results are saved.
:SEARch:PEAK Commands (see page 985)	Commands to set up searching for FFT peaks.
:SBUS<n>:CAN:COUNT:SPEC (see page 783)	Returns the count for the number of Spec errors (Ack + Form + Stuff + CRC errors).
:SBUS<n>:CAN:FDSPoint (see page 787)	Sets the CAN FD sample point.
:SBUS<n>:CAN:SIGNal:FDBaud rate (see page 792)	Sets the CAN FD baud rate.
:SBUS<n>:CAN:TRIGger:IDFilter (see page 797)	Specifies, in certain error and bit trigger modes, whether triggers are filtered by CAN IDs.
:SBUS<n>:CAN:TRIGger:PATtern:DATA:DLC (see page 799)	Specifies the DLC value to be used in the CAN FD data trigger mode.

Command	Description
:SBUS<n>:CAN:TRIGger:PATtern:DATA:STARt (see page 801)	Specifies the starting byte position for CAN FD data triggers.
:SBUS<n>:SENT Commands (see page 897)	Commands for using the SENT triggering and serial decode feature.
:SEARch:SERial:SENT Commands (see page 1048)	Commands for searching SENT serial decode events.
:SYSTem:PERSONa[:MANUFACTurer] (see page 1067)	Lets you change the manufacturer string portion of the identification string returned by the *IDN? query.
:SYSTem:PERSONa[:MANUFACTurer]:DEFault (see page 1068)	Sets manufacturer string to "KEYSIGHT TECHNOLOGIES".

Changed Commands

Command	Differences From InfiniiVision 4000 X-Series Oscilloscopes
:ACQuire:MODE (see page 257)	The ETIME option is not supported in the 3000T X-Series oscilloscopes.
:DEMO:FUNCTion (see page 326)	The DCMotor, HARMonics, COUPLing, CFD, and SENT functions are now available with the DSOXEDK educator's kit license.
:DISPlay:ANNotation<n> (see page 344)	You can now define up to four annotations.
:DISPlay:ANNotation<n>:BACKground (see page 345)	
:DISPlay:ANNotation<n>:COLor (see page 346)	
:DISPlay:ANNotation<n>:TEXT (see page 347)	
:DISPlay:SIDebar (see page 356)	The EVENTS and COUNTER options are now available.
:DISPlay:VECTors (see page 358)	Always ON (no display as dots option).
:DVM:MODE (see page 363)	The FREQuency option has been replaced by the new Chapter 11 , ":COUNTER Commands," starting on page 313.
:EXTernal:RANGe (see page 368)	When using 1:1 probe attenuation, the range can only be set to 8.0 V.
:FUNCTion<m>:OPERation (see page 418)	The SMOOth, ENVELOpe, MAXHold, and MINHold operations are added.
:POWer:SIGNals:AUTOsetup (see page 683)	The RDSVce option is now available.
:SBUS<n>:CAN:COUNt:OVERload (see page 781)	Always returns zero.

Command	Differences From InfiniiVision 4000 X-Series Oscilloscopes
:SBUS<n>:CAN:TRIGger (see page 794)	Has additional parameters that support CAN FD triggering.
:SBUS<n>:MODE (see page 759)	The SENT mode is now available with the DSOXT3SENSOR SENT serial decode and triggering license.
:SEARCh:MODE (see page 973)	The PEAK option has been added to enable searching for FFT peaks (see “:SEARCh:PEAK Commands” on page 985).
:SEARCh:SERial:CAN:MODE (see page 1007)	Has additional parameters that support CAN FD searching.
:WAVEform:SOURce:SUBSource (see page 1221)	You can use FAST (alias for SUB0) to get SENT fast channel data or SLOW (alias for SBUS1) to get SENT slow channel data.

Discontinued Commands

Discontinued Command	Current Command Equivalent	Comments
:ACQUIRE:RSIGNAL	none	There is no 10 MHz REF connector on the 3000T X-Series oscilloscopes.
:COMPLIANCE Commands	none	USB signal quality analysis is not supported on the 3000T X-Series oscilloscopes.
:DVM:FREQUENCY?	:COUNTER:CURRENT? (see page 315)	The :DVM:FREQUENCY? query has been replaced by the new Chapter 11 , “:COUNTER Commands,” starting on page 313.
:SAVE:COMPLIANCE:USB[:START]	none	USB signal quality analysis is not supported on the 3000T X-Series oscilloscopes.
:SBUS<n>:USB Commands	none	USB serial decode and triggering is not supported on the 3000T X-Series oscilloscopes.
:SEARCh:SERial:USB Commands	none	Searching USB serial decode is not supported on the 3000T X-Series oscilloscopes.
:TIMEbase:REFClock	none	There is no 10 MHz REF connector on the 3000T X-Series oscilloscopes.

Discontinued Command	Current Command Equivalent	Comments
:WGEN<w>:TRACk	none	There is only one waveform generator output on the 3000T X-Series oscilloscopes.
:WGEN<w>:TRACk:AMPLitude	none	
:WGEN<w>:TRACk:CSIGNAL	none	
:WGEN<w>:TRACk:FREQuency	none	

2 Setting Up

Step 1. Install Keysight IO Libraries Suite software / 54

Step 2. Connect and set up the oscilloscope / 55

Step 3. Verify the oscilloscope connection / 57

This chapter explains how to install the Keysight IO Libraries Suite software, connect the oscilloscope to the controller PC, set up the oscilloscope, and verify the oscilloscope connection.

Step 1. Install Keysight IO Libraries Suite software

- 1 Download the Keysight IO Libraries Suite software from the Keysight web site at:
 - <http://www.keysight.com/find/iolib>
- 2 Run the setup file, and follow its installation instructions.

Step 2. Connect and set up the oscilloscope

The 3000T X-Series oscilloscope has two different interfaces you can use for programming:

- USB (device port).
- LAN. To configure the LAN interface, press the **[Utility]** key on the front panel, then press the **I/O** softkey, then press the **Configure** softkey.

These interfaces are always active.

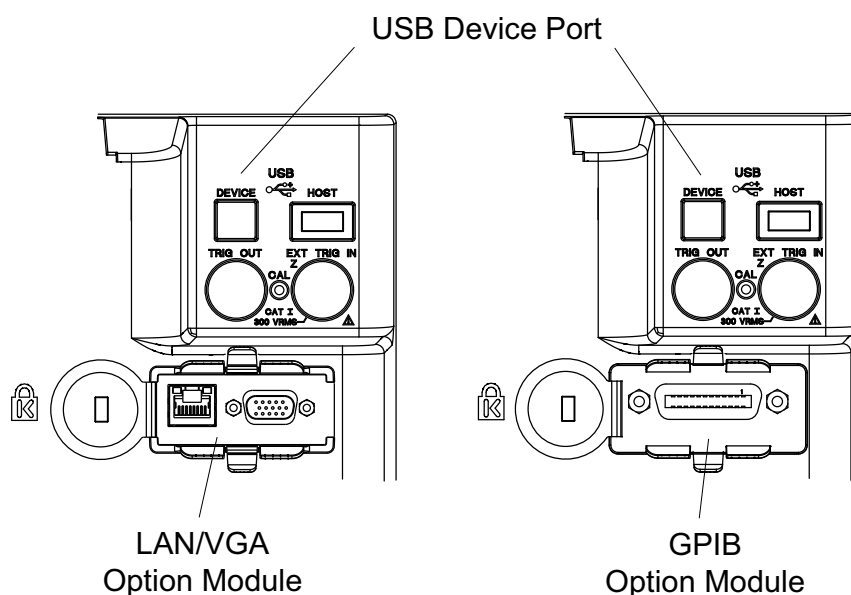

Figure 1 Control Connectors on Rear Panel

Using the USB (Device) Interface

- 1 Connect a USB cable from the controller PC's USB port to the "USB DEVICE" port on the back of the oscilloscope.

This is a USB 2.0 high-speed port.

Using the LAN Interface

- 1 If the controller PC is not already connected to the local area network (LAN), do that first.
- 2 Contact your network administrator about adding the oscilloscope to the network.

Find out if automatic configuration via DHCP or AutoIP can be used. Also, find out whether your network supports Dynamic DNS or Multicast DNS.

If automatic configuration is not supported, get the oscilloscope's network parameters (hostname, domain, IP address, subnet mask, gateway IP, DNS IP, etc.).

- 3 Connect the oscilloscope to the local area network (LAN) by inserting LAN cable into the "LAN" port on the LAN/VGA option module.
- 4 Configure the oscilloscope's LAN interface:
 - a Press the **Configure** softkey until "LAN" is selected.
 - b Press the **LAN Settings** softkey.
 - c Press the **Config** softkey, and enable all the configuration options supported by your network.
 - d If automatic configuration is not supported, press the **Addresses** softkey.

Use the **Modify** softkey (and the other softkeys and the Entry knob) to enter the IP Address, Subnet Mask, Gateway IP, and DNS IP values.

When you are done, press the **[Back up]** key.

- e Press the **Host name** softkey. Use the softkeys and the Entry knob to enter the Host name.

When you are done, press the **[Back up]** key.

Using the GPIB Interface

- 1 Connect a GPIB cable from the controller PC's GPIB interface to the "GPIB" port on the GPIB option module.
- 2 Configure the oscilloscope's GPIB interface:
 - a Press the **Configure** softkey until "GPIB" is selected.
 - b Use the Entry knob to select the **Address** value.

Step 3. Verify the oscilloscope connection

- 1 On the controller PC, click on the Keysight IO Control icon in the taskbar and choose **Connection Expert** from the popup menu.

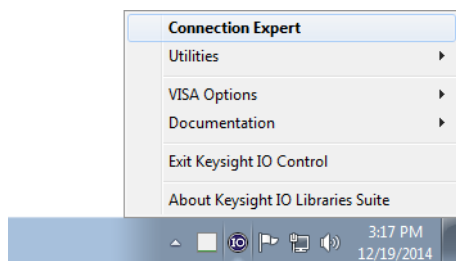

- 2 In the Keysight Connection Expert application, instruments connected to the controller's USB and GPIB interfaces as well as instruments on the same LAN subnet should automatically appear in the Instruments tab.

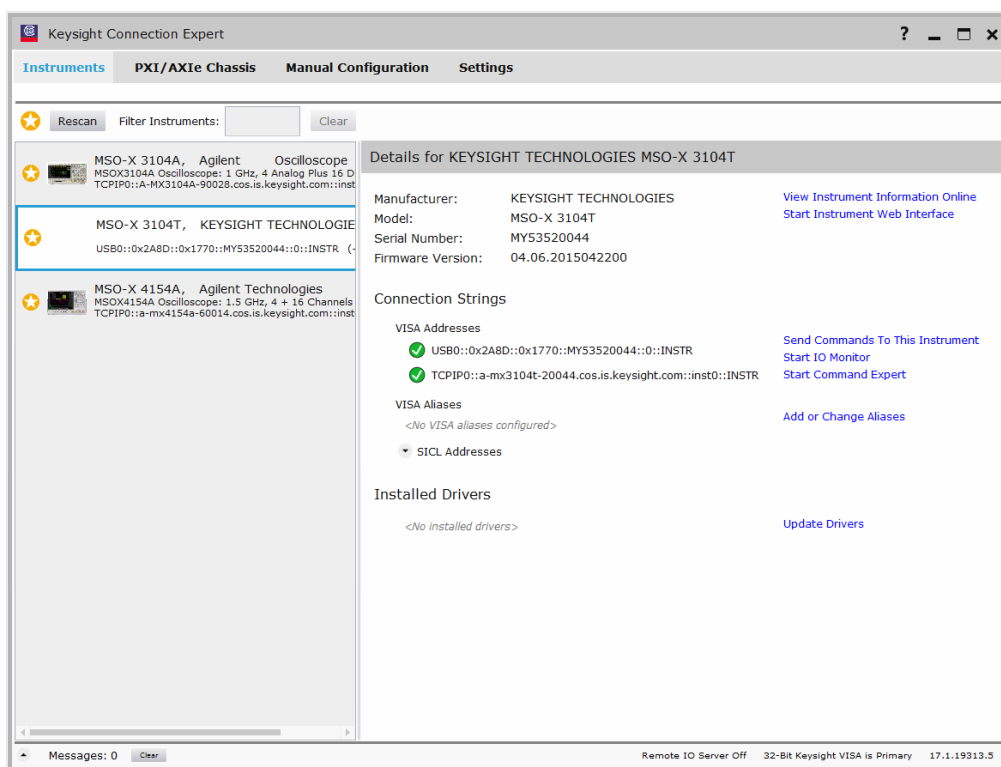

- 3 If your instrument does not appear, you can add it using the Manual Configuration tab.

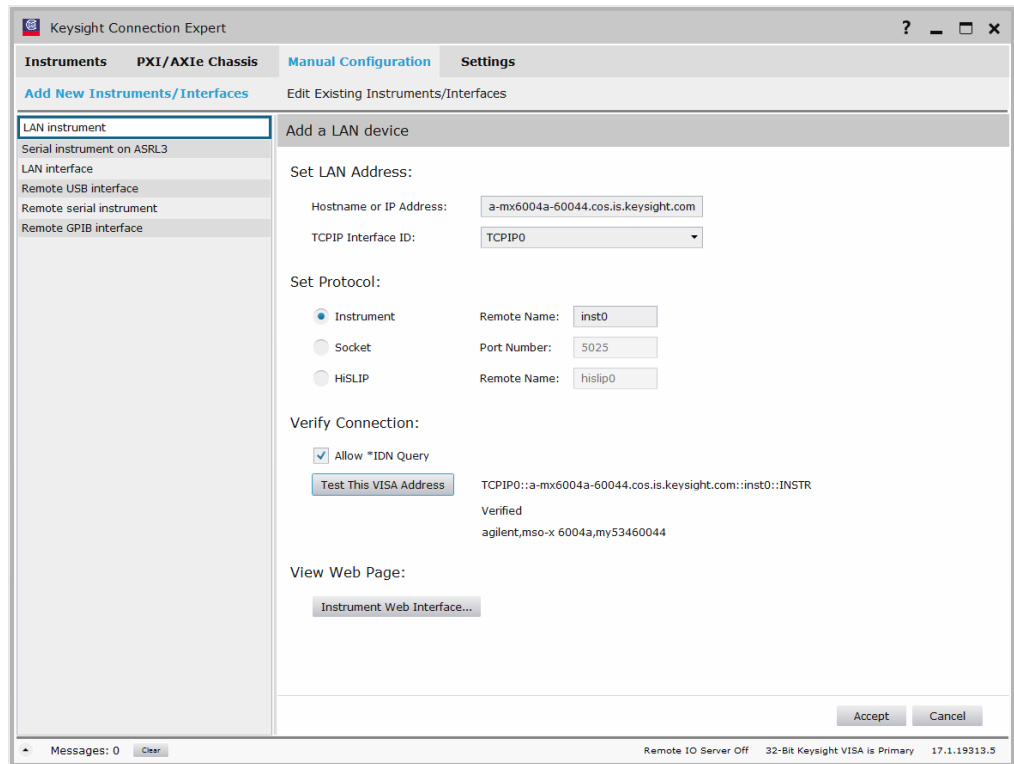

For example, to add a device:

- a Select **LAN instrument** in the list on the left.
- b Enter the oscilloscope's **Hostname** or **IP address**.
- c Select the protocol.
- d Select **Instrument** under Set Protocol.
- e Click **Test This VISA Address** to verify the connection.
- f If the connection test is successful, click **Accept** to add the instrument.

If the connection test is not successful, go back and verify the LAN connections and the oscilloscope setup.

- 4 Test some commands on the instrument:
- a In the Details for the selected instrument, click **Send Commands To This Instrument**.

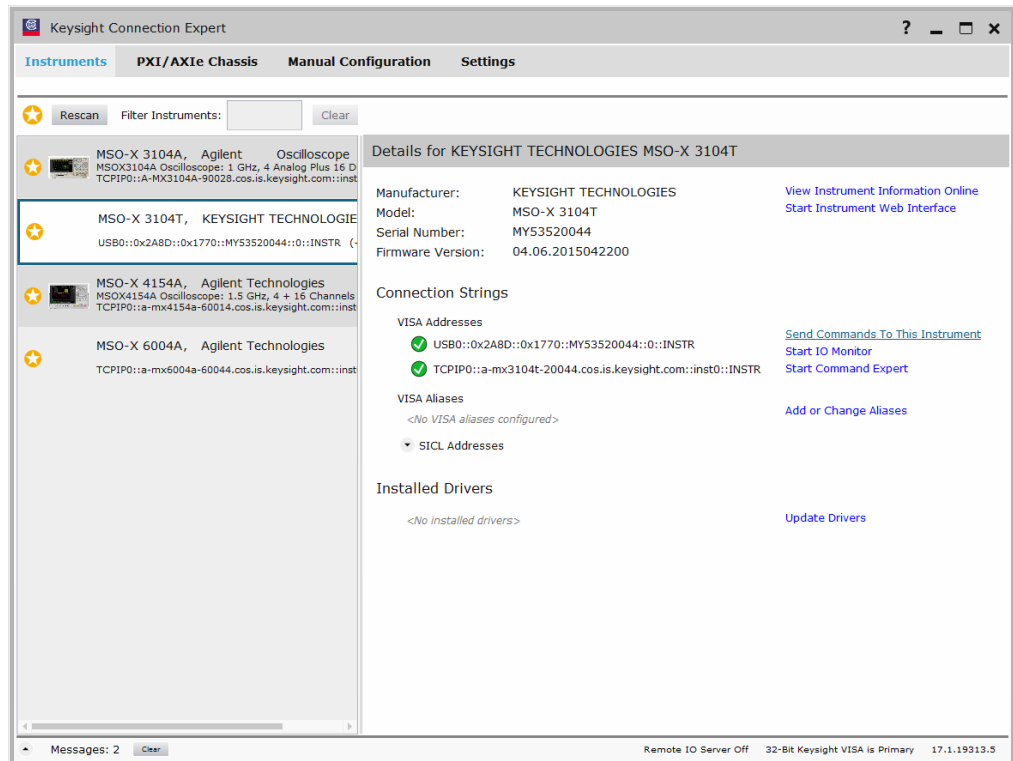

- b In the Keysight Interactive IO application, enter commands in the **Command** field and press **Send Command**, **Read Response**, or **Send & Read**.

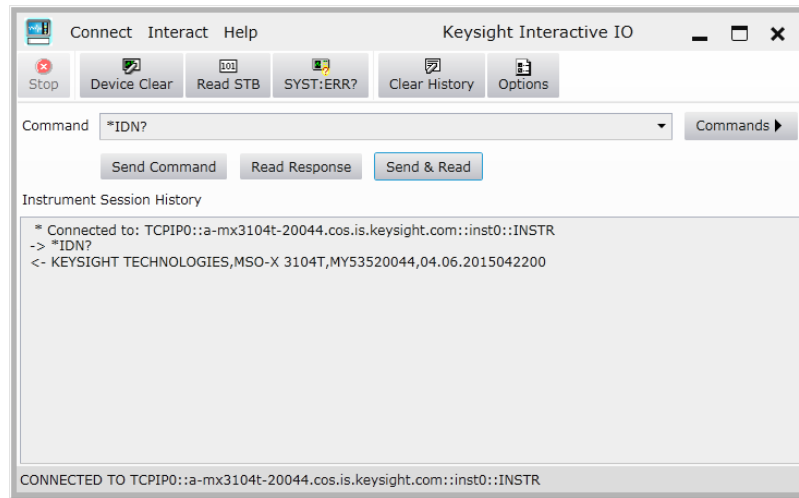

- c Choose **Connect > Exit** from the menu to exit the Keysight Interactive IO application.
- 5 In the Keysight Connection Expert application, choose **File > Exit** from the menu to exit the application.

3 Getting Started

Basic Oscilloscope Program Structure / 62

Programming the Oscilloscope / 64

Other Ways of Sending Commands / 73

This chapter gives you an overview of programming the 3000T X-Series oscilloscopes. It describes basic oscilloscope program structure and shows how to program the oscilloscope using a few simple examples.

The getting started examples show how to send oscilloscope setup, data capture, and query commands, and they show how to read query results.

NOTE

Language for Program Examples

The programming examples in this guide are written in Visual Basic using the Keysight VISA COM library.

Basic Oscilloscope Program Structure

The following figure shows the basic structure of every program you will write for the oscilloscope.

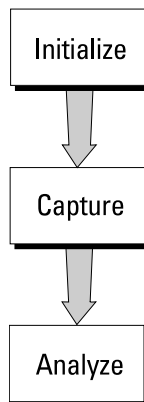

Initializing

To ensure consistent, repeatable performance, you need to start the program, controller, and oscilloscope in a known state. Without correct initialization, your program may run correctly in one instance and not in another. This might be due to changes made in configuration by previous program runs or from the front panel of the oscilloscope.

- Program initialization defines and initializes variables, allocates memory, or tests system configuration.
- Controller initialization ensures that the interface to the oscilloscope is properly set up and ready for data transfer.
- Oscilloscope initialization sets the channel configuration, channel labels, threshold voltages, trigger specification, trigger mode, timebase, and acquisition type.

Capturing Data

Once you initialize the oscilloscope, you can begin capturing data for analysis. Remember that while the oscilloscope is responding to commands from the controller, it is not performing acquisitions. Also, when you change the oscilloscope configuration, any data already captured will most likely be rendered.

To collect data, you use the `:DIGitize` command. This command clears the waveform buffers and starts the acquisition process. Acquisition continues until acquisition memory is full, then stops. The acquired data is displayed by the oscilloscope, and the captured data can be measured, stored in acquisition

memory in the oscilloscope, or transferred to the controller for further analysis. Any additional commands sent while :DIGitize is working are buffered until :DIGitize is complete.

You could also put the oscilloscope into run mode, then use a wait loop in your program to ensure that the oscilloscope has completed at least one acquisition before you make a measurement. Keysight does not recommend this because the needed length of the wait loop may vary, causing your program to fail. :DIGitize, on the other hand, ensures that data capture is complete. Also, :DIGitize, when complete, stops the acquisition process so that all measurements are on displayed data, not on a constantly changing data set.

Analyzing Captured Data

After the oscilloscope has completed an acquisition, you can find out more about the data, either by using the oscilloscope measurements or by transferring the data to the controller for manipulation by your program. Built-in measurements include: frequency, duty cycle, period, positive pulse width, and negative pulse width.

Using the :WAVEform commands, you can transfer the data to your controller. You may want to display the data, compare it to a known good measurement, or simply check logic patterns at various time intervals in the acquisition.

Programming the Oscilloscope

- "Referencing the IO Library" on page 64
- "Opening the Oscilloscope Connection via the IO Library" on page 65
- "Using :AUToscale to Automate Oscilloscope Setup" on page 66
- "Using Other Oscilloscope Setup Commands" on page 66
- "Capturing Data with the :DIGitize Command" on page 67
- "Reading Query Responses from the Oscilloscope" on page 69
- "Reading Query Results into String Variables" on page 70
- "Reading Query Results into Numeric Variables" on page 70
- "Reading Definite-Length Block Query Response Data" on page 70
- "Sending Multiple Queries and Reading Results" on page 71
- "Checking Instrument Status" on page 72

Referencing the IO Library

No matter which instrument programming library you use (SICL, VISA, or VISA COM), you must reference the library from your program.

In C/C++, you must tell the compiler where to find the include and library files (see the Keysight IO Libraries Suite documentation for more information).

To reference the Keysight VISA COM library in Visual Basic for Applications (VBA, which comes with Microsoft Office products like Excel):

- 1 Choose **Tools > References...** from the main menu.
- 2 In the References dialog, check the "VISA COM 5.5 Type Library".

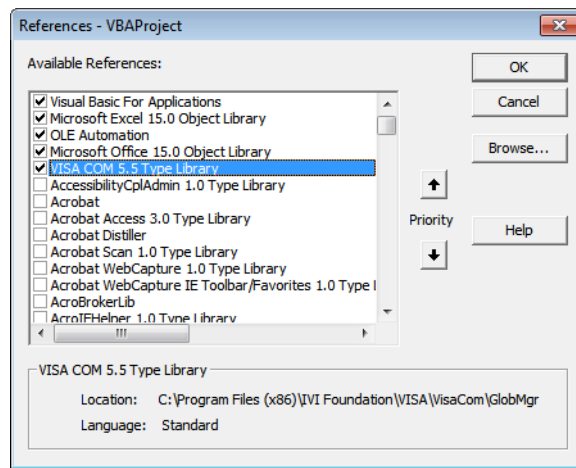

- 3 Click **OK**.

To reference the Keysight VISA COM library in Microsoft Visual Basic 6.0:

- 1 Choose **Project > References...** from the main menu.
- 2 In the References dialog, check the "VISA COM 5.5 Type Library".
- 3 Click **OK**.

Opening the Oscilloscope Connection via the IO Library

PC controllers communicate with the oscilloscope by sending and receiving messages over a remote interface. Once you have opened a connection to the oscilloscope over the remote interface, programming instructions normally appear as ASCII character strings embedded inside write statements of the programming language. Read statements are used to read query responses from the oscilloscope.

For example, when using the Keysight VISA COM library in Visual Basic (after opening the connection to the instrument using the ResourceManager object's Open method), the FormattedIO488 object's WriteString, WriteNumber, WriteList, or WriteIIEEBlock methods are used for sending commands and queries. After a query is sent, the response is read using the ReadString, ReadNumber, ReadList, or ReadIIEEBlock methods.

The following Visual Basic statements open the connection and send a command that turns on the oscilloscope's label display.

```
Dim myMgr As VisaComLib.ResourceManager
Dim myScope As VisaComLib.FormattedIO488

Set myMgr = New VisaComLib.ResourceManager
Set myScope = New VisaComLib.FormattedIO488

' Open the connection to the oscilloscope. Get the VISA Address from the
' Keysight Connection Expert (installed with Keysight IO Libraries Suite
').
Set myScope.IO = myMgr.Open("<VISA Address>")

' Send a command.
myScope.WriteString ":DISPlay:LABel ON"
```

The ":DISPLAY:LABEL ON" in the above example is called a *program message*. Program messages are explained in more detail in "[Program Message Syntax](#)" on page 1385.

Initializing the Interface and the Oscilloscope

To make sure the bus and all appropriate interfaces are in a known state, begin every program with an initialization statement. When using the Keysight VISA COM library, you can use the resource session object's Clear method to clear the interface buffer:

```

Dim myMgr As VisaComLib.ResourceManager
Dim myScope As VisaComLib.FormattedIO488

Set myMgr = New VisaComLib.ResourceManager
Set myScope = New VisaComLib.FormattedIO488

' Open the connection to the oscilloscope. Get the VISA Address from the
' Keysight Connection Expert (installed with Keysight IO Libraries Suite
').
Set myScope.IO = myMgr.Open("<VISA Address>")

' Clear the interface buffer and set the interface timeout to 10 seconds
.
myScope.IO.Clear
myScope.IO.Timeout = 10000

```

When you are using GPIB, CLEAR also resets the oscilloscope's parser. The parser is the program which reads in the instructions which you send it.

After clearing the interface, initialize the instrument to a preset state:

```
myScope.WriteString "*RST"
```

NOTE**Information for Initializing the Instrument**

The actual commands and syntax for initializing the instrument are discussed in [Chapter 5, "Common \(*\) Commands,"](#) starting on page 187.

Refer to the Keysight IO Libraries Suite documentation for information on initializing the interface.

Using :AUToscale to Automate Oscilloscope Setup

The :AUToscale command performs a very useful function for unknown waveforms by setting up the vertical channel, time base, and trigger level of the instrument.

The syntax for the autoscale command is:

```
myScope.WriteString ":AUToscale"
```

Using Other Oscilloscope Setup Commands

A typical oscilloscope setup would set the vertical range and offset voltage, the horizontal range, delay time, delay reference, trigger mode, trigger level, and slope. An example of the commands that might be sent to the oscilloscope are:

```

myScope.WriteString ":CHANnel1:PROBe 10"
myScope.WriteString ":CHANnel1:RANGe 16"
myScope.WriteString ":CHANnel1:OFFSet 1.00"
myScope.WriteString ":TIMEbase:MODE MAIN"
myScope.WriteString ":TIMEbase:RANGe 1E-3"
myScope.WriteString ":TIMEbase:DELay 100E-6"

```

Vertical is set to 16 V full-scale (2 V/div) with center of screen at 1 V and probe attenuation set to 10. This example sets the time base at 1 ms full-scale (100 ms/div) with a delay of 100 μ s.

Example Oscilloscope Setup Code

This program demonstrates the basic command structure used to program the oscilloscope.

```
' Initialize the instrument interface to a known state.
myScope.IO.Clear
myScope.IO.Timeout = 10000 ' Set interface timeout to 10 seconds.

' Initialize the instrument to a preset state.
myScope.WriteString "*RST"

' Set the time base mode to normal with the horizontal time at
' 50 ms/div with 0 s of delay referenced at the center of the
' graticule.
myScope.WriteString ":TIMEbase:RANGE 5E-4" ' Time base to 50 us/div.
myScope.WriteString ":TIMEbase:DElay 0" ' Delay to zero.
myScope.WriteString ":TIMEbase:REfERENCE CENTER" ' Display ref. at
' center.

' Set the vertical range to 1.6 volts full scale with center screen
' at -0.4 volts with 10:1 probe attenuation and DC coupling.
myScope.WriteString ":CHANnel:PROBe 10" ' Probe attenuation
' to 10:1.
myScope.WriteString ":CHANnel:RANGE 1.6" ' Vertical range
' 1.6 V full scale.
myScope.WriteString ":CHANnel:OFFSet -0.4" ' Offset to -0.4.
myScope.WriteString ":CHANnel:COUPling DC" ' Coupling to DC.

' Configure the instrument to trigger at -0.4 volts with normal
' triggering.
myScope.WriteString ":TRIGger:SWEep NORMal" ' Normal triggering.
myScope.WriteString ":TRIGger:LEVel -0.4" ' Trigger level to -0.4.
myScope.WriteString ":TRIGger:SLOPe POSitive" ' Trigger on pos. slope.

' Configure the instrument for normal acquisition.
myScope.WriteString ":ACQuire:TYPE NORMal" ' Normal acquisition.
```

Capturing Data with the :DIGitize Command

The :DIGitize command captures data that meets the specifications set up by the :ACQuire subsystem. When the digitize process is complete, the acquisition is stopped. The captured data can then be measured by the instrument or transferred to the controller for further analysis. The captured data consists of two parts: the waveform data record, and the preamble.

NOTE**Ensure New Data is Collected**

When you change the oscilloscope configuration, the waveform buffers are cleared. Before doing a measurement, send the :DIGitize command to the oscilloscope to ensure new data has been collected.

When you send the :DIGitize command to the oscilloscope, the specified channel signal is digitized with the current :ACQUIRE parameters. To obtain waveform data, you must specify the :WAVEform parameters for the SOURce channel, the FORMat type, and the number of POINTs prior to sending the :WAVEform:DATA? query.

NOTE**Set :TIMEbase:MODE to MAIN when using :DIGitize**

:TIMEbase:MODE must be set to MAIN to perform a :DIGitize command or to perform any :WAVEform subsystem query. A "Settings conflict" error message will be returned if these commands are executed when MODE is set to ROLL, XY, or WINDow (zoomed). Sending the *RST (reset) command will also set the time base mode to normal.

The number of data points comprising a waveform varies according to the number requested in the :ACQUIRE subsystem. The :ACQUIRE subsystem determines the number of data points, type of acquisition, and number of averages used by the :DIGitize command. This allows you to specify exactly what the digitized information contains.

The following program example shows a typical setup:

```
myScope.WriteString ":ACQUIRE:TYPE AVERage"
myScope.WriteString ":ACQUIRE:COMPLete 100"
myScope.WriteString ":ACQUIRE:COUNt 8"
myScope.WriteString ":DIGitize CHANnel1"
myScope.WriteString ":WAVEform:SOURce CHANnel1"
myScope.WriteString ":WAVEform:FORMat BYTE"
myScope.WriteString ":WAVEform:POINTs 500"
myScope.WriteString ":WAVEform:DATA?"
```

This setup places the instrument into the averaged mode with eight averages. This means that when the :DIGitize command is received, the command will execute until the signal has been averaged at least eight times.

After receiving the :WAVEform:DATA? query, the instrument will start passing the waveform information.

Digitized waveforms are passed from the instrument to the controller by sending a numerical representation of each digitized point. The format of the numerical representation is controlled with the :WAVEform:FORMat command and may be selected as BYTE, WORD, or ASCii.

The easiest method of transferring a digitized waveform depends on data structures, formatting available and I/O capabilities. You must scale the integers to determine the voltage value of each point. These integers are passed starting with the left most point on the instrument's display.

For more information, see the waveform subsystem commands and corresponding program code examples in [Chapter 34](#), “:WAVEform Commands,” starting on page 1195.

NOTE**Aborting a Digitize Operation Over the Programming Interface**

When using the programming interface, you can abort a digitize operation by sending a Device Clear over the bus (for example, `myScope.IO.Clear`).

Reading Query Responses from the Oscilloscope

After receiving a query (command header followed by a question mark), the instrument interrogates the requested function and places the answer in its output queue. The answer remains in the output queue until it is read or another command is issued. When read, the answer is transmitted across the interface to the designated listener (typically a controller).

The statement for reading a query response message from an instrument's output queue typically has a format specification for handling the response message.

When using the VISA COM library in Visual Basic, you use different read methods (`ReadString`, `ReadNumber`, `ReadList`, or `ReadIEEEBlock`) for the various query response formats. For example, to read the result of the query command `:CHANnel1:COUPling?` you would execute the statements:

```
myScope.WriteString ":CHANnel1:COUPling?"
Dim strQueryResult As String
strQueryResult = myScope.ReadString
```

This reads the current setting for the channel one coupling into the string variable `strQueryResult`.

All results for queries (sent in one program message) must be read before another program message is sent.

Sending another command before reading the result of the query clears the output buffer and the current response. This also causes an error to be placed in the error queue.

Executing a read statement before sending a query causes the controller to wait indefinitely.

The format specification for handling response messages depends on the programming language.

Reading Query Results into String Variables

The output of the instrument may be numeric or character data depending on what is queried. Refer to the specific command descriptions for the formats and types of data returned from queries.

NOTE

Express String Variables Using Exact Syntax

In Visual Basic, string variables are case sensitive and must be expressed exactly the same each time they are used.

The following example shows numeric data being returned to a string variable:

```
myScope.WriteString ":CHANnel1:RANGe?"
Dim strQueryResult As String
strQueryResult = myScope.ReadString
MsgBox "Range (string):" + strQueryResult
```

After running this program, the controller displays:

Range (string): +40.0E+00

Reading Query Results into Numeric Variables

The following example shows numeric data being returned to a numeric variable:

```
myScope.WriteString ":CHANnel1:RANGe?"
Dim varQueryResult As Variant
varQueryResult = myScope.ReadNumber
MsgBox "Range (variant):" + CStr(varQueryResult)
```

After running this program, the controller displays:

Range (variant): 40

Reading Definite-Length Block Query Response Data

Definite-length block query response data allows any type of device-dependent data to be transmitted over the system interface as a series of 8-bit binary data bytes. This is particularly useful for sending large quantities of data or 8-bit extended ASCII codes. The syntax is a pound sign (#) followed by a non-zero digit representing the number of digits in the decimal integer. After the non-zero digit is the decimal integer that states the number of 8-bit data bytes being sent. This is followed by the actual data.

For example, for transmitting 1000 bytes of data, the syntax would be:

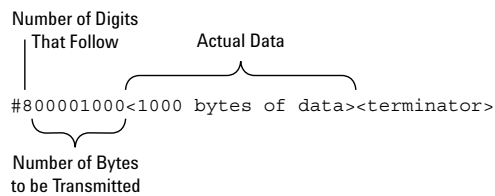

Figure 2 Definite-length block response data

The "8" states the number of digits that follow, and "00001000" states the number of bytes to be transmitted.

The VISA COM library's `ReadIEEEBlock` and `WriteIEEEBlock` methods understand the definite-length block syntax, so you can simply use variables that contain the data:

```
' Read oscilloscope setup using ":SYSTEM:SETup?" query.
myScope.WriteString ":SYSTEM:SETup?"
Dim varQueryResult As Variant
varQueryResult = myScope.ReadIEEEBlock(BinaryType_UI1)

' Write learn string back to oscilloscope using ":SYSTEM:SETup" command:
myScope.WriteIEEEBlock ":SYSTEM:SETup ", varQueryResult
```

Sending Multiple Queries and Reading Results

You can send multiple queries to the instrument within a single command string, but you must also read them back as a single query result. This can be accomplished by reading them back into a single string variable, multiple string variables, or multiple numeric variables.

For example, to read the `:TIMEbase:RANGE?;DELay?` query result into a single string variable, you could use the commands:

```
myScope.WriteString ":TIMEbase:RANGE?;DELay?"
Dim strQueryResult As String
strQueryResult = myScope.ReadString
MsgBox "Timebase range; delay:" + strQueryResult
```

When you read the result of multiple queries into a single string variable, each response is separated by a semicolon. For example, the output of the previous example would be:

```
Timebase range; delay: <range_value>;<delay_value>
```

To read the `:TIMEbase:RANGE?;DELay?` query result into multiple string variables, you could use the `ReadList` method to read the query results into a string array variable using the commands:

```
myScope.WriteString ":TIMEbase:RANGE?;DELay?"
Dim strResults() As String
```

```
strResults() = myScope.ReadList(ASCIIType_BSTR)
MsgBox "Timebase range: " + strResults(0) + ", delay: " + strResults(1)
```

To read the :TIMEbase:RANGE?;DElay? query result into multiple numeric variables, you could use the ReadList method to read the query results into a variant array variable using the commands:

```
myScope.WriteString ":TIMEbase:RANGE?;DElay?"
Dim varResults() As Variant
varResults() = myScope.ReadList
MsgBox "Timebase range: " + FormatNumber(varResults(0) * 1000, 4) + _
      " ms, delay: " + FormatNumber(varResults(1) * 1000000, 4) + " us"
```

Checking Instrument Status

Status registers track the current status of the instrument. By checking the instrument status, you can find out whether an operation has been completed, whether the instrument is receiving triggers, and more.

For more information, see [Chapter 39](#), “Status Reporting,” starting on page 1349 which explains how to check the status of the instrument.

Other Ways of Sending Commands

Standard Commands for Programmable Instrumentation (SCPI) can also be sent via a Telnet socket or through the Browser Web Control:

- **"Telnet Sockets"** on page 73
- **"Sending SCPI Commands Using Browser Web Control"** on page 73

Telnet Sockets

The following information is provided for programmers who wish to control the oscilloscope with SCPI commands in a Telnet session.

To connect to the oscilloscope via a telnet socket, issue the following command:

```
telnet <hostname> 5024
```

where <hostname> is the hostname of the oscilloscope. This will give you a command line with prompt.

For a command line without a prompt, use port 5025. For example:

```
telnet <hostname> 5025
```

Sending SCPI Commands Using Browser Web Control

To send SCPI commands using the Browser Web Control feature, establish a connection to the oscilloscope via LAN as described in the *InfiniiVision 3000T X-Series Oscilloscopes User's Guide*. When you make the connection to the oscilloscope via LAN and the instrument's welcome page is displayed, select the **Browser Web Control** tab, then select the **Remote Programming** link.

4 Commands Quick Reference

Command Summary / 76

Syntax Elements / 183

Command Summary

- Common (*) Commands Summary (see [page 78](#))
- Root (:) Commands Summary (see [page 81](#))
- :ACQuire Commands Summary (see [page 84](#))
- :BUS<n> Commands Summary (see [page 85](#))
- :CALibrate Commands Summary (see [page 86](#))
- :CHANnel<n> Commands Summary (see [page 87](#))
- :COUNter Commands Summary (see [page 89](#))
- :DEMO Commands Summary (see [page 90](#))
- :DIGital<n> Commands Summary (see [page 90](#))
- :DISPlay Commands Summary (see [page 91](#))
- :DVM Commands Summary (see [page 93](#))
- :EXTernal Trigger Commands Summary (see [page 93](#))
- :FFT Commands Summary (see [page 93](#))
- :FUNction Commands Summary (see [page 95](#))
- :HARDcopy Commands Summary (see [page 99](#))
- :LISTer Commands Summary (see [page 100](#))
- :MARKer Commands Summary (see [page 100](#))
- :MEASure Commands Summary (see [page 102](#))
- :MEASure Power Commands Summary (see [page 117](#))
- :MTEST Commands Summary (see [page 121](#))
- :POD<n> Commands Summary (see [page 123](#))
- :POWer Commands Summary (see [page 124](#))
- :RECall Commands Summary (see [page 131](#))
- :SAVE Commands Summary (see [page 132](#))
- General :SBUS<n> Commands Summary (see [page 135](#))
- :SBUS<n>:A429 Commands Summary (see [page 135](#))
- :SBUS<n>:CAN Commands Summary (see [page 137](#))
- :SBUS<n>:CXPI Commands Summary (see [page 139](#))
- :SBUS<n>:FLEXray Commands Summary (see [page 140](#))
- :SBUS<n>:I2S Commands Summary (see [page 142](#))
- :SBUS<n>:IIC Commands Summary (see [page 144](#))
- :SBUS<n>:LIN Commands Summary (see [page 145](#))
- :SBUS<n>:M1553 Commands Summary (see [page 146](#))

- :SBUS<n>:SENT Commands Summary (see [page 147](#))
- :SBUS<n>:SPI Commands Summary (see [page 149](#))
- :SBUS<n>:UART Commands Summary (see [page 151](#))
- General :SEARCh Commands Summary (see [page 153](#))
- :SEARCh:EDGE Commands Summary (see [page 153](#))
- :SEARCh:GLITCh Commands Summary (see [page 154](#))
- :SEARCh:PEAK Commands Summary (see [page 154](#))
- :SEARCh:RUNT Commands Summary (see [page 155](#))
- :SEARCh:TRANSition Commands Summary (see [page 155](#))
- :SEARCh:SERial:A429 Commands Summary (see [page 156](#))
- :SEARCh:SERial:CAN Commands Summary (see [page 157](#))
- :SEARCh:SERial:FLEXray Commands Summary (see [page 157](#))
- :SEARCh:SERial:I2S Commands Summary (see [page 158](#))
- :SEARCh:SERial:IIC Commands Summary (see [page 159](#))
- :SEARCh:SERial:LIN Commands Summary (see [page 159](#))
- :SEARCh:SERial:M1553 Commands Summary (see [page 160](#))
- :SEARCh:SERial:SENT Commands Summary (see [page 161](#))
- :SEARCh:SERial:SPI Commands Summary (see [page 161](#))
- :SEARCh:SERial:UART Commands Summary (see [page 162](#))
- :SYSTem Commands Summary (see [page 162](#))
- :TIMebase Commands Summary (see [page 164](#))
- General :TRIGGer Commands Summary (see [page 165](#))
- :TRIGGer:DELAy Commands Summary (see [page 166](#))
- :TRIGGer:EBURst Commands Summary (see [page 166](#))
- :TRIGGer[:EDGE] Commands Summary (see [page 167](#))
- :TRIGGer:GLITCh Commands Summary (see [page 168](#))
- :TRIGGer:NFC Commands Summary (see [page 169](#))
- :TRIGGer:OR Commands Summary (see [page 170](#))
- :TRIGGer:PATTern Commands Summary (see [page 170](#))
- :TRIGGer:RUNT Commands Summary (see [page 171](#))
- :TRIGGer:SHOLd Commands Summary (see [page 172](#))
- :TRIGGer:TRANSition Commands Summary (see [page 172](#))
- :TRIGGer:TV Commands Summary (see [page 173](#))
- :TRIGGer:USB Commands Summary (see [page 174](#))
- :TRIGGer:ZONE Commands Summary (see [page 174](#))

- :WAVEform Commands Summary (see [page 175](#))
- :WGEN Commands Summary (see [page 178](#))
- :WMEMory<r> Commands Summary (see [page 181](#))

Table 2 Common (*) Commands Summary

Command	Query	Options and Query Returns																																				
*CLS (see page 191)	n/a	n/a																																				
*ESE <mask> (see page 192)	*ESE? (see page 193)	<p><mask> ::= 0 to 255; an integer in NR1 format:</p> <table border="1"> <thead> <tr> <th>Bit</th> <th>Weight</th> <th>Name</th> <th>Enables</th> </tr> </thead> <tbody> <tr> <td>7</td> <td>128</td> <td>PON</td> <td>Power On</td> </tr> <tr> <td>6</td> <td>64</td> <td>URQ</td> <td>User Request</td> </tr> <tr> <td>5</td> <td>32</td> <td>CME</td> <td>Command Error</td> </tr> <tr> <td>4</td> <td>16</td> <td>EXE</td> <td>Execution Error</td> </tr> <tr> <td>3</td> <td>8</td> <td>DDE</td> <td>Dev. Dependent Error</td> </tr> <tr> <td>2</td> <td>4</td> <td>QYE</td> <td>Query Error</td> </tr> <tr> <td>1</td> <td>2</td> <td>RQL</td> <td>Request Control</td> </tr> <tr> <td>0</td> <td>1</td> <td>OPC</td> <td>Operation Complete</td> </tr> </tbody> </table>	Bit	Weight	Name	Enables	7	128	PON	Power On	6	64	URQ	User Request	5	32	CME	Command Error	4	16	EXE	Execution Error	3	8	DDE	Dev. Dependent Error	2	4	QYE	Query Error	1	2	RQL	Request Control	0	1	OPC	Operation Complete
Bit	Weight	Name	Enables																																			
7	128	PON	Power On																																			
6	64	URQ	User Request																																			
5	32	CME	Command Error																																			
4	16	EXE	Execution Error																																			
3	8	DDE	Dev. Dependent Error																																			
2	4	QYE	Query Error																																			
1	2	RQL	Request Control																																			
0	1	OPC	Operation Complete																																			
n/a	*ESR? (see page 194)	<status> ::= 0 to 255; an integer in NR1 format																																				
n/a	*IDN? (see page 194)	<p>KEYSIGHT TECHNOLOGIES,<model>,<serial number>,X.XX.XX</p> <p><model> ::= the model number of the instrument</p> <p><serial number> ::= the serial number of the instrument</p> <p><X.XX.XX> ::= the software revision of the instrument</p>																																				
n/a	*LRN? (see page 197)	<learn_string> ::= current instrument setup as a block of data in IEEE 488.2 # format																																				
*OPC (see page 198)	*OPC? (see page 198)	ASCII "1" is placed in the output queue when all pending device operations have completed.																																				

Table 2 Common (*) Commands Summary (continued)

Command	Query	Options and Query Returns
n/a	*OPT? (see page 199)	<pre> <return_value> ::= 0,0,<license info> <license info> ::= <All field>, <reserved>, <MSO>, <Xilinx FPGA Probe>, <Memory>, <Low Speed Serial>, <Automotive Serial>, <reserved>, <FlexRay Serial>, <Power Measurements>, <RS-232/UART Serial>, <reserved>, <Mask Test>, <reserved>, <Bandwidth>, <reserved>, <reserved>, <reserved>, <I2S Serial>, <reserved>, <Educator's Kit>, <Waveform Generator>, <MIL-1553/ARINC 429 Serial>, <Extended Video>, <reserved>, <reserved>, <reserved>, <reserved>, <Digital Voltmeter>, <Spectrum Visualizer>, <reserved>, <reserved>, <USB 2.0 Low/Full Speed>, <USB 2.0 High Speed> <All field> ::= {0 All} <reserved> ::= 0 <MSO> ::= {0 MSO} <Xilinx FPGA Probe> ::= {0 FPGAX} <Memory> ::= {0 MEMUP} <Low Speed Serial> ::= {0 EMBD} <Automotive Serial> ::= {0 AUTO} <FlexRay Serial> ::= {0 FLEX} <Power Measurements> ::= {0 PWR} <RS-232/UART Serial> ::= {0 COMP} <Mask Test> ::= {0 MASK} <Bandwidth> ::= {0 BW20 BW50} <I2S Serial> ::= {0 AUDIO} <Educator's Kit> ::= {0 EDK} <Waveform Generator> ::= {0 WAVEGEN} <MIL-1553/ARINC 429 Serial> ::= {0 AERO} <Extended Video> ::= {0 VID} <Digital Voltmeter> ::= {0 DVM} <Spectrum Visualizer> ::= {0 ASV} <USB 2.0 Low/Full Speed> ::= {0 USF} <USB 2.0 High Speed> ::= {0 USH} </pre>

Table 2 Common (*) Commands Summary (continued)

Command	Query	Options and Query Returns
*RCL <value> (see page 201)	n/a	<value> ::= {0 1 4 5 6 7 8 9}
*RST (see page 202)	n/a	See *RST (Reset) (see page 202)
*SAV <value> (see page 205)	n/a	<value> ::= {0 1 4 5 6 7 8 9}
*SRE <mask> (see page 206)	*SRE? (see page 207)	<p><mask> ::= sum of all bits that are set, 0 to 255; an integer in NR1 format. <mask> ::= following values:</p> <pre> Bit Weight Name Enables ----- 7 128 OPER Operation Status Reg 6 64 ---- (Not used.) 5 32 ESB Event Status Bit 4 16 MAV Message Available 3 8 ---- (Not used.) 2 4 MSG Message 1 2 USR User 0 1 TRG Trigger </pre>
n/a	*STB? (see page 208)	<p><value> ::= 0 to 255; an integer in NR1 format, as shown in the following:</p> <pre> Bit Weight Name "1" Indicates ----- 7 128 OPER Operation status condition occurred. 6 64 RQS/ Instrument is MSS requesting service. 5 32 ESB Enabled event status condition occurred. 4 16 MAV Message available. 3 8 ---- (Not used.) 2 4 MSG Message displayed. 1 2 USR User event condition occurred. 0 1 TRG A trigger occurred. </pre>
*TRG (see page 210)	n/a	n/a
n/a	*TST? (see page 211)	<result> ::= 0 or non-zero value; an integer in NR1 format
*WAI (see page 212)	n/a	n/a

Table 3 Root (:) Commands Summary

Command	Query	Options and Query Returns
:ACTivity (see page 217)	:ACTivity? (see page 217)	<return value> ::= <edges>,<levels> <edges> ::= presence of edges (32-bit integer in NR1 format) <levels> ::= logical highs or lows (32-bit integer in NR1 format)
n/a	:AER? (see page 218)	{0 1}; an integer in NR1 format
:AUToscale [<source>[,...,<source>]] (see page 219)	n/a	<source> ::= CHANNEL<n> for DSO models <source> ::= {CHANNEL<n> DIGital<d> POD1 POD2} for MSO models <source> can be repeated up to 5 times <n> ::= 1 to (# analog channels) in NR1 format <d> ::= 0 to (# digital channels - 1) in NR1 format
:AUToscale:AMODE <value> (see page 221)	:AUToscale:AMODE? (see page 221)	<value> ::= {NORMAL CURRENT}}
:AUToscale:CHANNELs <value> (see page 222)	:AUToscale:CHANNELs? (see page 222)	<value> ::= {ALL DISPLAYed}}
:AUToscale:FDEBug {0 OFF} {1 ON} (see page 223)	:AUToscale:FDEBug? (see page 223)	{0 1}
:BLANK [<source>] (see page 224)	n/a	<source> ::= {CHANNEL<n> FUNCTION<m> MATH<m> FFT SBUS{1 2} WMemory<r>} for DSO models <source> ::= {CHANNEL<n> DIGital<d> POD{1 2} BUS{1 2} FUNCTION<m> MATH<m> FFT SBUS{1 2} WMemory<r>} for MSO models <n> ::= 1 to (# analog channels) in NR1 format <d> ::= 0 to (# digital channels - 1) in NR1 format <m> ::= 1 to (# math functions) in NR1 format <r> ::= 1 to (# ref waveforms) in NR1 format

Table 3 Root (:): Commands Summary (continued)

Command	Query	Options and Query Returns
:DIGitize [<source>[,...,<source>]] (see page 225)	n/a	<source> ::= {CHANnel<n> FUNCTION<m> MATH<m> FFT SBUS{1 2}} for DSO models <source> ::= {CHANnel<n> DIGital<d> POD{1 2} BUS{1 2} FUNCTION<m> MATH<m> FFT SBUS{1 2}} for MSO models <source> can be repeated up to 5 times <n> ::= 1 to (# analog channels) in NR1 format <d> ::= 0 to (# digital channels - 1) in NR1 format <m> ::= 1 to (# math functions) in NR1 format
:HWEenable <n> (see page 227)	:HWEenable? (see page 227)	<n> ::= 16-bit integer in NR1 format
n/a	:HWEregister:CONDition? (see page 229)	<n> ::= 16-bit integer in NR1 format
n/a	:HWEregister[:EVENT]? (see page 230)	<n> ::= 16-bit integer in NR1 format
:MTEenable <n> (see page 231)	:MTEenable? (see page 231)	<n> ::= 16-bit integer in NR1 format
n/a	:MTEregister[:EVENT]? (see page 233)	<n> ::= 16-bit integer in NR1 format
:OPEE <n> (see page 235)	:OPEE? (see page 236)	<n> ::= 15-bit integer in NR1 format
n/a	:OPERregister:CONDition? (see page 237)	<n> ::= 15-bit integer in NR1 format
n/a	:OPERregister[:EVENT]? (see page 239)	<n> ::= 15-bit integer in NR1 format

Table 3 Root (:): Commands Summary (continued)

Command	Query	Options and Query Returns
:OVLenable <mask> (see page 241)	:OVLenable? (see page 242)	<mask> ::= 16-bit integer in NR1 format as shown: Bit Weight Input ----- 10 1024 Ext Trigger Fault 9 512 Channel 4 Fault 8 256 Channel 3 Fault 7 128 Channel 2 Fault 6 64 Channel 1 Fault 4 16 Ext Trigger OVL 3 8 Channel 4 OVL 2 4 Channel 3 OVL 1 2 Channel 2 OVL 0 1 Channel 1 OVL
n/a	:OVLRegister? (see page 243)	<value> ::= integer in NR1 format. See OVLenable for <value>
:PRINT [<options>] (see page 245)	n/a	<options> ::= [<print option>][,...,<print option>] <print option> ::= {COLor GRAYscale PRINter0 BMP8bit BMP PNG NOFactors FACTors} <print option> can be repeated up to 5 times.
:RUN (see page 246)	n/a	n/a
n/a	:SERial (see page 247)	<return value> ::= unquoted string containing serial number
:SINGle (see page 248)	n/a	n/a
n/a	:STATus? <display> (see page 249)	{0 1} <display> ::= {CHANnel<n> DIGital<d> POD{1 2} BUS{1 2} FUNction<m> MATH<m> FFT SBUS{1 2} WMEMory<r>} <n> ::= 1 to (# analog channels) in NR1 format <d> ::= 0 to (# digital channels - 1) in NR1 format <m> ::= 1 to (# math functions) in NR1 format <r> ::= 1 to (# ref waveforms) in NR1 format
:STOP (see page 250)	n/a	n/a

Table 3 Root (:) Commands Summary (continued)

Command	Query	Options and Query Returns
n/a	:TER? (see page 251)	{0 1}
:VIEW <source> (see page 252)	n/a	<p><source> ::= {CHANNEL<n> FUNCTION<m> MATH<m> FFT SBUS{1 2} WMemory<r>} for DSO models</p> <p><source> ::= {CHANNEL<n> DIGITAL<d> POD{1 2} BUS{1 2} FUNCTION<m> MATH<m> FFT SBUS{1 2} WMemory<r>} for MSO models</p> <p><n> ::= 1 to (# analog channels) in NR1 format</p> <p><d> ::= 0 to (# digital channels - 1) in NR1 format</p> <p><m> ::= 1 to (# math functions) in NR1 format</p> <p><r> ::= 1 to (# ref waveforms) in NR1 format</p>

Table 4 :ACQUIRE Commands Summary

Command	Query	Options and Query Returns
:ACQUIRE:COMPLETE <complete> (see page 255)	:ACQUIRE:COMPLETE? (see page 255)	<complete> ::= 100; an integer in NR1 format
:ACQUIRE:COUNT <count> (see page 256)	:ACQUIRE:COUNT? (see page 256)	<count> ::= an integer from 2 to 65536 in NR1 format
:ACQUIRE:MODE <mode> (see page 257)	:ACQUIRE:MODE? (see page 257)	<mode> ::= {RTIME ETIME SEGMENTED}
n/a	:ACQUIRE:POINTS? (see page 258)	<# points> ::= an integer in NR1 format
:ACQUIRE:SEGMENTED:ANALYZE (see page 259)	n/a	n/a (with Option SGM)
:ACQUIRE:SEGMENTED:COUNT <count> (see page 260)	:ACQUIRE:SEGMENTED:COUNT? (see page 260)	<count> ::= an integer from 2 to 1000 in NR1 format (with Option SGM)
:ACQUIRE:SEGMENTED:INDEX <index> (see page 261)	:ACQUIRE:SEGMENTED:INDEX? (see page 261)	<index> ::= an integer from 1 to 1000 in NR1 format (with Option SGM)

Table 4 :ACquire Commands Summary (continued)

Command	Query	Options and Query Returns
n/a	:ACquire:SRATE? (see page 264)	<sample_rate> ::= sample rate (samples/s) in NR3 format
:ACquire:TYPE <type> (see page 265)	:ACquire:TYPE? (see page 265)	<type> ::= {NORMAL AVERAGE HRESolution PEAK}

Table 5 :BUS<n> Commands Summary

Command	Query	Options and Query Returns
:BUS<n>:BIT<m> {{0 OFF} {1 ON}} (see page 269)	:BUS<n>:BIT<m>? (see page 269)	{0 1} <n> ::= 1 or 2; an integer in NR1 format <m> ::= 0-15; an integer in NR1 format
:BUS<n>:BITS <channel_list>, {{0 OFF} {1 ON}} (see page 270)	:BUS<n>:BITS? (see page 270)	<channel_list>, {0 1} <channel_list> ::= (@<m>, <m>:<m> ...) where "," is separator and ":" is range <n> ::= 1 or 2; an integer in NR1 format <m> ::= 0-15; an integer in NR1 format
:BUS<n>:CLEar (see page 272)	n/a	<n> ::= 1 or 2; an integer in NR1 format
:BUS<n>:DISPlay {{0 OFF} {1 ON}} (see page 273)	:BUS<n>:DISPlay? (see page 273)	{0 1} <n> ::= 1 or 2; an integer in NR1 format

Table 5 :BUS<n> Commands Summary (continued)

Command	Query	Options and Query Returns
:BUS<n>:LAbel <string> (see page 274)	:BUS<n>:LAbel? (see page 274)	<string> ::= quoted ASCII string up to 10 characters <n> ::= 1 or 2; an integer in NR1 format
:BUS<n>:MASK <mask> (see page 275)	:BUS<n>:MASK? (see page 275)	<mask> ::= 32-bit integer in decimal, <nondecimal>, or <string> <nondecimal> ::= #Hnn...n where n ::= {0,...,9 A,...,F} for hexadecimal <nondecimal> ::= #Bnn...n where n ::= {0 1} for binary <string> ::= "0xnn...n" where n ::= {0,...,9 A,...,F} for hexadecimal <n> ::= 1 or 2; an integer in NR1 format

Table 6 :CALibrate Commands Summary

Command	Query	Options and Query Returns
n/a	:CALibrate:DATE? (see page 279)	<return value> ::= <year>, <month>, <day>; all in NR1 format
:CALibrate:LAbel <string> (see page 280)	:CALibrate:LAbel? (see page 280)	<string> ::= quoted ASCII string up to 32 characters
:CALibrate:OUTPut <signal> (see page 281)	:CALibrate:OUTPut? (see page 281)	<signal> ::= {TRIGgers MASK WAVEgen WGEN1 WGEN2} Note: WAVE and WGEN1 are equivalent. Note: WGEN2 only available on models with 2 WaveGen outputs.
n/a	:CALibrate:PROtected? (see page 283)	{PROtected UNPROtected}
:CALibrate:START (see page 284)	n/a	n/a

Table 6 :CALibrate Commands Summary (continued)

Command	Query	Options and Query Returns
n/a	:CALibrate:STATus? (see page 285)	<return value> ::= <status_code>,<status_string> <status_code> ::= an integer status code <status_string> ::= an ASCII status string
n/a	:CALibrate:TEMPeratur e? (see page 286)	<return value> ::= degrees C delta since last cal in NR3 format
n/a	:CALibrate:TIME? (see page 287)	<return value> ::= <hours>,<minutes>,<seconds>; all in NR1 format

Table 7 :CHANnel<n> Commands Summary

Command	Query	Options and Query Returns
:CHANnel<n>:BWLimit { {0 OFF} {1 ON} } (see page 292)	:CHANnel<n>:BWLimit? (see page 292)	{0 1} <n> ::= 1 to (# analog channels) in NR1 format
:CHANnel<n>:COUpling <coupling> (see page 293)	:CHANnel<n>:COUpling? (see page 293)	<coupling> ::= {AC DC} <n> ::= 1 to (# analog channels) in NR1 format
:CHANnel<n>:DISPlay { {0 OFF} {1 ON} } (see page 294)	:CHANnel<n>:DISPlay? (see page 294)	{0 1} <n> ::= 1 to (# analog channels) in NR1 format
:CHANnel<n>:IMPedance <impedance> (see page 295)	:CHANnel<n>:IMPedance ? (see page 295)	<impedance> ::= {ONEMeg FIFTy} <n> ::= 1 to (# analog channels) in NR1 format
:CHANnel<n>:INVert { {0 OFF} {1 ON} } (see page 296)	:CHANnel<n>:INVert? (see page 296)	{0 1} <n> ::= 1 to (# analog channels) in NR1 format
:CHANnel<n>:LABel <string> (see page 297)	:CHANnel<n>:LABel? (see page 297)	<string> ::= any series of 32 or less ASCII characters enclosed in quotation marks <n> ::= 1 to (# analog channels) in NR1 format
:CHANnel<n>:OFFSet <offset>[suffix] (see page 298)	:CHANnel<n>:OFFSet? (see page 298)	<offset> ::= Vertical offset value in NR3 format [suffix] ::= {V mV} <n> ::= 1-2 or 1-4; in NR1 format

Table 7 :CHANnel<n> Commands Summary (continued)

Command	Query	Options and Query Returns
:CHANnel<n>:PROBe <attenuation> (see page 299)	:CHANnel<n>:PROBe? (see page 299)	<attenuation> ::= Probe attenuation ratio in NR3 format <n> ::= 1-2 or 1-4r in NR1 format
:CHANnel<n>:PROBe:HEA D[:TYPE] <head_param> (see page 300)	:CHANnel<n>:PROBe:HEA D[:TYPE]? (see page 300)	<head_param> ::= {SEND0 SEND6 SEND12 SEND20 DIFF0 DIFF6 DIFF12 DIFF20 NONE} <n> ::= 1 to (# analog channels) in NR1 format
n/a	:CHANnel<n>:PROBe:ID? (see page 301)	<probe id> ::= unquoted ASCII string up to 11 characters <n> ::= 1 to (# analog channels) in NR1 format
:CHANnel<n>:PROBe:MMO Del <value> (see page 302)	:CHANnel<n>:PROBe:MMO Del? (see page 302)	<value> ::= {P5205 P5210 P6205 P6241 P6243 P6245 P6246 P6247 P6248 P6249 P6250 P6251 P670X P671X TCP202} <n> ::= 1 to (# analog channels) in NR1 format
:CHANnel<n>:PROBe:RSE Nse <value> (see page 303)	:CHANnel<n>:PROBe:RSE Nse? (see page 303)	<value> ::= Ohms in NR3 format <n> ::= 1 to (# analog channels) in NR1 format
:CHANnel<n>:PROBe:SKE W <skew_value> (see page 304)	:CHANnel<n>:PROBe:SKE W? (see page 304)	<skew_value> ::= -100 ns to +100 ns in NR3 format <n> ::= 1 to (# analog channels) in NR1 format
:CHANnel<n>:PROBe:STY Pe <signal type> (see page 305)	:CHANnel<n>:PROBe:STY Pe? (see page 305)	<signal type> ::= {DIFFerential SINGLE} <n> ::= 1 to (# analog channels) in NR1 format
:CHANnel<n>:PROBe:ZOO M {{0 OFF} {1 ON}} (see page 306)	:CHANnel<n>:PROBe:ZOO M? (see page 306)	<setting> ::= {0 1} <n> ::= 1 to (# analog channels) in NR1 format
:CHANnel<n>:PROTection (see page 307)	:CHANnel<n>:PROTection? (see page 307)	{NORM TRIP} <n> ::= 1 to (# analog channels) in NR1 format
:CHANnel<n>:RANGe <range>[suffix] (see page 308)	:CHANnel<n>:RANGe? (see page 308)	<range> ::= Vertical full-scale range value in NR3 format [suffix] ::= {V mV} <n> ::= 1 to (# analog channels) in NR1 format

Table 7 :CHANnel<n> Commands Summary (continued)

Command	Query	Options and Query Returns
:CHANnel<n>:SCALE <scale>[suffix] (see page 309)	:CHANnel<n>:SCALE? (see page 309)	<scale> ::= Vertical units per division value in NR3 format [suffix] ::= {V mV} <n> ::= 1 to (# analog channels) in NR1 format
:CHANnel<n>:UNITs <units> (see page 310)	:CHANnel<n>:UNITs? (see page 310)	<units> ::= {VOLT AMPere} <n> ::= 1 to (# analog channels) in NR1 format
:CHANnel<n>:VERNier {{0 OFF} {1 ON}} (see page 311)	:CHANnel<n>:VERNier? (see page 311)	{0 1} <n> ::= 1 to (# analog channels) in NR1 format

Table 8 :COUNter Commands Summary

Command	Query	Options and Query Returns
n/a	:COUNter:CURREnt? (see page 315)	<value> ::= current counter value in NR3 format
:COUNter:ENABle {{0 OFF} {1 ON}} (see page 316)	:COUNter:ENABle? (see page 316)	{0 1}
:COUNter:MODE <mode> (see page 317)	:COUNter:MODE (see page 317)	<mode> ::= {FREQUency PERiod TOTalize}
:COUNter:NDIGits <value> (see page 318)	:COUNter:NDIGits (see page 318)	<value> ::= 3 to 8 in NR1 format
:COUNter:SOURce <source> (see page 319)	:COUNter:SOURce? (see page 319)	<source> ::= {CHANnel<n> TQEvent} <n> ::= 1 to (# analog channels) in NR1 format
:COUNter:TOTalize:CLE ar (see page 320)	n/a	n/a
:COUNter:TOTalize:GAT E:ENABle {{0 OFF} {1 ON}} (see page 321)	:COUNter:TOTalize:GAT E:ENABle? (see page 321)	{0 1}
:COUNter:TOTalize:GAT E:POLarity <polarity> (see page 322)	:COUNter:TOTalize:GAT E:POLarity? (see page 322)	<polarity> ::= {{NEGative FALLing} {POSitive RISing}}

Table 8 :COUNTER Commands Summary (continued)

Command	Query	Options and Query Returns
:COUNTER:TOTALize:GATE:SOURCE <source> (see page 323)	:COUNTER:TOTALize:GATE:SOURCE? (see page 323)	<source> ::= CHANNEL<n> <n> ::= 1 to (# analog channels) in NR1 format
:COUNTER:TOTALize:SLOPE <slope> (see page 324)	:COUNTER:TOTALize:SLOPE? (see page 324)	<slope> ::= {NEGative FALLing} {POSitive RISing}}

Table 9 :DEMO Commands Summary

Command	Query	Options and Query Returns
:DEMO:FUNCTION <signal> (see page 326)	:DEMO:FUNCTION? (see page 329)	<signal> ::= {SINusoid NOISy PHASE RINGing SINGLE AM CLK GLITCh BURSt MSO RUNT TRANSition RFBurst SHOLd LFSine FMBurst ETE CAN LIN UART I2C SPI I2S CANLin ARINc FLEXray MIL MIL2 USB NMONotonic}
:DEMO:FUNCTION:PHASE:PHASE <angle> (see page 330)	:DEMO:FUNCTION:PHASE:PHASE? (see page 330)	<angle> ::= angle in degrees from 0 to 360 in NR3 format
:DEMO:OUTPUT {{0 OFF} {1 ON}} (see page 331)	:DEMO:OUTPUT? (see page 331)	{0 1}

Table 10 :DIGITAL<d> Commands Summary

Command	Query	Options and Query Returns
:DIGITAL<d>:DISPLAY {{0 OFF} {1 ON}} (see page 335)	:DIGITAL<d>:DISPLAY? (see page 335)	<d> ::= 0 to (# digital channels - 1) in NR1 format {0 1}
:DIGITAL<d>:LABEL <string> (see page 336)	:DIGITAL<d>:LABEL? (see page 336)	<d> ::= 0 to (# digital channels - 1) in NR1 format <string> ::= any series of 10 or less ASCII characters enclosed in quotation marks

Table 10 :DIGital<d> Commands Summary (continued)

Command	Query	Options and Query Returns
:DIGital<d>:POSition <position> (see page 337)	:DIGital<d>:POSition? (see page 337)	<d> ::= 0 to (# digital channels - 1) in NR1 format <position> ::= 0-7 if display size = large, 0-15 if size = medium, 0-31 if size = small Returns -1 when there is no space to display the digital waveform.
:DIGital<d>:SIZE <value> (see page 338)	:DIGital<d>:SIZE? (see page 338)	<d> ::= 0 to (# digital channels - 1) in NR1 format <value> ::= {SMALl MEDium LARGe}
:DIGital<d>:THReshold <value>[suffix] (see page 339)	:DIGital<d>:THReshold ? (see page 339)	<d> ::= 0 to (# digital channels - 1) in NR1 format <value> ::= {CMOS ECL TTL <user defined value>} <user defined value> ::= value in NR3 format from -8.00 to +8.00 [suffix] ::= {V mV uV}

Table 11 :DISPlay Commands Summary

Command	Query	Options and Query Returns
:DISPlay:ANNotation<n > {{0 OFF} {1 ON}} (see page 344)	:DISPlay:ANNotation<n >? (see page 344)	{0 1} <n> ::= an integer from 1 to 4 in NR1 format.
:DISPlay:ANNotation<n >:BACKground <mode> (see page 345)	:DISPlay:ANNotation<n >:BACKground? (see page 345)	<mode> ::= {OPAQue INVerted TRANSPARENT} <n> ::= an integer from 1 to 4 in NR1 format.
:DISPlay:ANNotation<n >:COLor <color> (see page 346)	:DISPlay:ANNotation<n >:COLor? (see page 346)	<color> ::= {CH1 CH2 CH3 CH4 DIG MATH REF MARKer WHITe RED} <n> ::= an integer from 1 to 4 in NR1 format.
:DISPlay:ANNotation<n >:TEXT <string> (see page 347)	:DISPlay:ANNotation<n >:TEXT? (see page 347)	<string> ::= quoted ASCII string (up to 254 characters) <n> ::= an integer from 1 to 4 in NR1 format.

Table 11 :DISPlay Commands Summary (continued)

Command	Query	Options and Query Returns
:DISPlay:ANNotation<n>:X1Position <value> (see page 348)	:DISPlay:ANNotation<n>:X1Position? (see page 348)	<value> ::= an integer from 0 to (800 - width of annotation) in NR1 format. <n> ::= an integer from 1 to 4 in NR1 format.
:DISPlay:ANNotation<n>:Y1Position <value> (see page 349)	:DISPlay:ANNotation<n>:Y1Position? (see page 349)	<value> ::= an integer from 0 to (480 - height of annotation) in NR1 format. <n> ::= an integer from 1 to 4 in NR1 format.
:DISPlay:CLear (see page 350)	n/a	n/a
n/a	:DISPlay:DATA? [<format>] [,] [<palette>] (see page 351)	<format> ::= {BMP BMP8bit PNG} <palette> ::= {COLor GRAYscale} <display data> ::= data in IEEE 488.2 # format
:DISPlay:INTensity:WAVeform <value> (see page 352)	:DISPlay:INTensity:WAVeform? (see page 352)	<value> ::= an integer from 0 to 100 in NR1 format.
:DISPlay:LAbel {{0 OFF} {1 ON}} (see page 353)	:DISPlay:LAbel? (see page 353)	{0 1}
:DISPlay:LAbList <binary block> (see page 354)	:DISPlay:LAbList? (see page 354)	<binary block> ::= an ordered list of up to 75 labels, each 10 characters maximum, separated by newline characters
:DISPlay:MEnu <menu> (see page 355)	n/a	<menu> ::= {MASK MEASure SEGmented LISter POWer}
:DISPlay:SIDebar <sidebar> (see page 356)	n/a	<sidebar> ::= {SUMmary CURSors MEASurements DVM NAVigate CONTrols EVEnts COUNter}
:DISPlay:PERsistence <value> (see page 357)	:DISPlay:PERsistence? (see page 357)	<value> ::= {MINimum INFinite <time>} <time> ::= seconds in in NR3 format from 100E-3 to 60E0
:DISPlay:VECTors {1 ON} (see page 358)	:DISPlay:VECTors? (see page 358)	1

Table 12 :DVM Commands Summary

Command	Query	Options and Query Returns
:DVM:ARANge {{0 OFF} {1 ON}} (see page 360)	:DVM:ARANge? (see page 360)	{0 1}
n/a	:DVM:CURREnt? (see page 361)	<dvm_value> ::= floating-point number in NR3 format
:DVM:ENABLe {{0 OFF} {1 ON}} (see page 362)	:DVM:ENABle? (see page 362)	{0 1}
:DVM:MODE <mode> (see page 363)	:DVM:MODE? (see page 363)	<dvm_mode> ::= {ACRMs DC DCRMs}
:DVM:SOURce <source> (see page 364)	:DVM:SOURce? (see page 364)	<source> ::= {CHANnel<n>} <n> ::= 1-2 or 1-4 in NR1 format

Table 13 :EXtErnal Trigger Commands Summary

Command	Query	Options and Query Returns
:EXtErnal:BWLimit <bwlimit> (see page 366)	:EXtErnal:BWLimit? (see page 366)	<bwlimit> ::= {0 OFF}
:EXtErnal:PROBe <attenuation> (see page 367)	:EXtErnal:PROBe? (see page 367)	<attenuation> ::= probe attenuation ratio in NR3 format
:EXtErnal:RANge <range> [<suffix>] (see page 368)	:EXtErnal:RANge? (see page 368)	<range> ::= vertical full-scale range value in NR3 format <suffix> ::= {V mV}
:EXtErnal:UNITs <units> (see page 369)	:EXtErnal:UNITs? (see page 369)	<units> ::= {VOLT AMPere}

Table 14 :FFT Commands Summary

Command	Query	Options and Query Returns
:FFT:AVERage:COUNT <count> (see page 373)	:FFT:AVERage:COUNT? (see page 373)	<count> ::= an integer from 2 to 65536 in NR1 format.
:FFT:CENTer <frequency> (see page 374)	:FFT:CENTer? (see page 374)	<frequency> ::= the current center frequency in NR3 format. The range of legal values is from -25 GHz to 25 GHz.
:FFT:CLear (see page 375)	n/a	n/a

Table 14 :FFT Commands Summary (continued)

Command	Query	Options and Query Returns
:FFT:DISPlay {{0 OFF} {1 ON}} (see page 376)	:FFT:DISPlay? (see page 376)	<s> ::= 1-6, in NR1 format. {0 1}
:FFT:DMODE <display_mode> (see page 377)	:FFT:DMODE? (see page 377)	<display_mode> ::= {NORMAL AVERAge MAXHold MINHold}
:FFT:FREQuency:START <frequency> (see page 379)	:FFT:FREQuency:START? (see page 379)	<frequency> ::= the start frequency in NR3 format.
:FFT:FREQuency:STOP <frequency> (see page 380)	:FFT:FREQuency:STOP? (see page 380)	<frequency> ::= the stop frequency in NR3 format.
:FFT:GATE <gating> (see page 381)	:FFT:GATE? (see page 381)	<gating> ::= {NONE ZOOM}
:FFT:OFFSet <offset> (see page 382)	:FFT:OFFSet? (see page 382)	<offset> ::= the value at center screen in NR3 format.
:FFT:RANGe <range> (see page 383)	:FFT:RANGe? (see page 383)	<range> ::= the full-scale vertical axis value in NR3 format.
:FFT:REfERENCE <level> (see page 384)	:FFT:REfERENCE? (see page 384)	<level> ::= the current reference level in NR3 format.
:FFT:SCALe <scale value>[<suffix>] (see page 385)	:FFT:SCALe? (see page 385)	<scale_value> ::= integer in NR1 format. <suffix> ::= dB
:FFT:SOURce1 <source> (see page 386)	:FFT:SOURce1? (see page 386)	<source> ::= {CHANnel<n> FUNction<c> MATH<c>} <n> ::= 1 to (# analog channels) in NR1 format. <c> ::= {1 2}
:FFT:SPAN (see page 387)	:FFT:SPAN? (see page 387)	 ::= the current frequency span in NR3 format. Legal values are 1 Hz to 100 GHz.
:FFT:VTYPe <units> (see page 388)	:FFT:VTYPe? (see page 388)	<units> ::= {DECibel VRMS}
:FFT:WINDow <window> (see page 389)	:FFT:WINDow? (see page 389)	<window> ::= {RECTangular HANNing FLATtop BHARRis}

Table 15 :FUNCTION<m> Commands Summary

Command	Query	Options and Query Returns
:FUNCTION<m>:AVERAge:COUNT <count> (see page 396)	:FUNCTION<m>:AVERAge:COUNT? (see page 396)	<count> ::= an integer from 2 to 65536 in NR1 format <m> ::= 1 to (# math functions) in NR1 format
:FUNCTION<m>:BUS:CLOCK <source> (see page 397)	:FUNCTION<m>:BUS:CLOCK? (see page 397)	<source> ::= {CHANnel<n> DIGital<d>} <n> ::= 1 to (# analog channels) in NR1 format <d> ::= 0 to (# digital channels - 1) in NR1 format <m> ::= 1 to (# math functions) in NR1 format
:FUNCTION<m>:BUS:SLOPE <slope> (see page 398)	:FUNCTION<m>:BUS:SLOPE? (see page 398)	<slope> ::= {NEGative POSitive EITHer} <m> ::= 1 to (# math functions) in NR1 format
:FUNCTION<m>:BUS:YINCrement <value> (see page 399)	:FUNCTION<m>:BUS:YINCrement? (see page 399)	<value> ::= value per bus code, in NR3 format <m> ::= 1 to (# math functions) in NR1 format
:FUNCTION<m>:BUS:YORigin <value> (see page 400)	:FUNCTION<m>:BUS:YORigin? (see page 400)	<value> ::= value at bus code = 0, in NR3 format <m> ::= 1 to (# math functions) in NR1 format
:FUNCTION<m>:BUS:YUNits <units> (see page 401)	:FUNCTION<m>:BUS:YUNits? (see page 401)	<units> ::= {VOLT AMPere NONE} <m> ::= 1 to (# math functions) in NR1 format
:FUNCTION<m>:CLEAr (see page 402)	n/a	n/a
:FUNCTION<m>:DISPlay {{0 OFF} {1 ON}} (see page 403)	:FUNCTION<m>:DISPlay? (see page 403)	{0 1} <m> ::= 1 to (# math functions) in NR1 format
:FUNCTION<m>[:FFT]:CENTer <frequency> (see page 404)	:FUNCTION<m>[:FFT]:CENTer? (see page 404)	<frequency> ::= the current center frequency in NR3 format. The range of legal values is from -25 GHz to 25 GHz. <m> ::= 1 to (# math functions) in NR1 format

Table 15 :FUNCTION<m> Commands Summary (continued)

Command	Query	Options and Query Returns
:FUNCTION<m>[:FFT]:FREQUENCY:START <frequency> (see page 405)	:FUNCTION<m>[:FFT]:FREQUENCY:START? (see page 405)	<frequency> ::= the start frequency in NR3 format. <m> ::= 1 to (# math functions) in NR1 format
:FUNCTION<m>[:FFT]:FREQUENCY:STOP <frequency> (see page 406)	:FUNCTION<m>[:FFT]:FREQUENCY:STOP? (see page 406)	<frequency> ::= the stop frequency in NR3 format. <m> ::= 1 to (# math functions) in NR1 format
:FUNCTION<m>[:FFT]:GATE <gating> (see page 407)	:FUNCTION<m>[:FFT]:GATE? (see page 407)	<gating> ::= {NONE ZOOM} <m> ::= 1-4 in NR1 format
:FUNCTION<m>[:FFT]:PHASE:REFERENCE <ref_point> (see page 408)	:FUNCTION<m>[:FFT]:PHASE:REFERENCE? (see page 408)	<ref_point> ::= {TRIGGER DISPLAY} <m> ::= 1-4 in NR1 format
:FUNCTION<m>[:FFT]:SPAN (see page 409)	:FUNCTION<m>[:FFT]:SPAN? (see page 409)	 ::= the current frequency span in NR3 format. Legal values are 1 Hz to 100 GHz. <m> ::= 1 to (# math functions) in NR1 format
:FUNCTION<m>[:FFT]:VTYPE <units> (see page 410)	:FUNCTION<m>[:FFT]:VTYPE? (see page 410)	<units> ::= {DECIBEL VRMS} for the FFT (magnitude) operation <units> ::= {DEGREES RADIANS} for the FFTPhase operation <m> ::= 1 to (# math functions) in NR1 format
:FUNCTION<m>[:FFT]:WINDOW <window> (see page 411)	:FUNCTION<m>[:FFT]:WINDOW? (see page 411)	<window> ::= {RECTANGULAR HANNING FLATTOP BHARRIS} <m> ::= 1 to (# math functions) in NR1 format
:FUNCTION<m>:FREQUENCY:HIGHPASS <3dB_freq> (see page 412)	:FUNCTION<m>:FREQUENCY:HIGHPASS? (see page 412)	<3dB_freq> ::= 3dB cutoff frequency value in NR3 format <m> ::= 1 to (# math functions) in NR1 format
:FUNCTION<m>:FREQUENCY:LOWPASS <3dB_freq> (see page 413)	:FUNCTION<m>:FREQUENCY:LOWPASS? (see page 413)	<3dB_freq> ::= 3dB cutoff frequency value in NR3 format <m> ::= 1 to (# math functions) in NR1 format
:FUNCTION<m>:INTEGRATE:IOFFSET <input_offset> (see page 414)	:FUNCTION<m>:INTEGRATE:IOFFSET? (see page 414)	<input_offset> ::= DC offset correction in NR3 format. <m> ::= 1 to (# math functions) in NR1 format

Table 15 :FUNCTION<m> Commands Summary (continued)

Command	Query	Options and Query Returns
:FUNCTION<m>:LINear:GAIn <value> (see page 415)	:FUNCTION<m>:LINear:GAIn? (see page 415)	<value> ::= 'A' in Ax + B, value in NR3 format <m> ::= 1 to (# math functions) in NR1 format
:FUNCTION<m>:LINear:OFFSet <value> (see page 416)	:FUNCTION<m>:LINear:OFFSet? (see page 416)	<value> ::= 'B' in Ax + B, value in NR3 format <m> ::= 1 to (# math functions) in NR1 format
:FUNCTION<m>:OFFSet <offset> (see page 417)	:FUNCTION<m>:OFFSet? (see page 417)	<offset> ::= the value at center screen in NR3 format. The range of legal values is +/-10 times the current sensitivity of the selected function. <m> ::= 1 to (# math functions) in NR1 format
:FUNCTION<m>:OPERation <operation> (see page 418)	:FUNCTION<m>:OPERation? (see page 420)	<operation> ::= {ADD SUBTract MULTiPLY DIVide INTegrate DIFF FFT FFTPhase SQRT MAGNify ABSolute SQUare LN LOG EXP TEN LOWPass HIGHpass AVERage LINear MAXimum MINimum PEAK MAXHold MINHold TREND BTIMing BSTate} <m> ::= 1 to (# math functions) in NR1 format
:FUNCTION<m>:RANGe <range> (see page 422)	:FUNCTION<m>:RANGe? (see page 422)	<range> ::= the full-scale vertical axis value in NR3 format. The range for ADD, SUBT, MULT is 8E-6 to 800E+3. The range for the INTegrate function is 8E-9 to 400E+3. The range for the DIFF function is 80E-3 to 8.0E12 (depends on current sweep speed). The range for the FFT function is 8 to 800 dBV. <m> ::= 1 to (# math functions) in NR1 format

Table 15 :FUNctIon<m> Commands Summary (continued)

Command	Query	Options and Query Returns
:FUNctIon<m>:REFErEnc e <level> (see page 423)	:FUNctIon<m>:REFErEnc e? (see page 423)	<level> ::= the value at center screen in NR3 format. The range of legal values is +/-10 times the current sensitivity of the selected function. <m> ::= 1 to (# math functions) in NR1 format
:FUNctIon<m>:SCALe <scale value>[<suffix>] (see page 424)	:FUNctIon<m>:SCALe? (see page 424)	<scale value> ::= integer in NR1 format <suffix> ::= {V dB} <m> ::= 1 to (# math functions) in NR1 format
:FUNctIon<m>:SMOoth:P OINTs <points> (see page 425)	:FUNctIon<m>:SMOoth:P OINTs? (see page 425)	<points> ::= odd integer in NR1 format
:FUNctIon<m>:SOURce1 <source> (see page 426)	:FUNctIon<m>:SOURce1? (see page 426)	<source> ::= {CHANnel<n> FUNctIon<c> MATH<c> WMEMory<r> BUS} <n> ::= 1 to (# analog channels) in NR1 format <c> ::= {1}, must be lower than <m> <r> ::= 1 to (# ref waveforms) in NR1 format ::= {1 2} <m> ::= 1 to (# math functions) in NR1 format
:FUNctIon<m>:SOURce2 <source> (see page 428)	:FUNctIon<m>:SOURce2? (see page 428)	<source> ::= {CHANnel<n> WMEMory<r> NONE} <n> ::= 1 to (# analog channels) in NR1 format <r> ::= 1 to (# ref waveforms) in NR1 format <m> ::= 1 to (# math functions) in NR1 format
:FUNctIon<m>:TRENd:ME ASurement <type> (see page 429)	:FUNctIon<m>:TRENd:ME ASurement? (see page 429)	<type> ::= {VAverage ACRMs VRATio PERioD FREQuency PWIDth NWIDth DUTYcycle RISetime FALLtime} <m> ::= 1 to (# math functions) in NR1 format

Table 16 :HARDcopy Commands Summary

Command	Query	Options and Query Returns
:HARDcopy:AREA <area> (see page 433)	:HARDcopy:AREA? (see page 433)	<area> ::= SCreen
:HARDcopy:APRinter <active_printer> (see page 434)	:HARDcopy:APRinter? (see page 434)	<active_printer> ::= {<index> <name>} <index> ::= integer index of printer in list <name> ::= name of printer in list
:HARDcopy:FACTors {{0 OFF} {1 ON}} (see page 435)	:HARDcopy:FACTors? (see page 435)	{0 1}
:HARDcopy:FFEed {{0 OFF} {1 ON}} (see page 436)	:HARDcopy:FFEed? (see page 436)	{0 1}
:HARDcopy:INKSaver {{0 OFF} {1 ON}} (see page 437)	:HARDcopy:INKSaver? (see page 437)	{0 1}
:HARDcopy:LAYout <layout> (see page 438)	:HARDcopy:LAYout? (see page 438)	<layout> ::= {LANDscape PORTrait}
:HARDcopy:NETWork:ADD Ress <address> (see page 439)	:HARDcopy:NETWork:ADD Ress? (see page 439)	<address> ::= quoted ASCII string
:HARDcopy:NETWork:APP Ly (see page 440)	n/a	n/a
:HARDcopy:NETWork:DOM ain <domain> (see page 441)	:HARDcopy:NETWork:DOM ain? (see page 441)	<domain> ::= quoted ASCII string
:HARDcopy:NETWork:PAS Sword <password> (see page 442)	n/a	<password> ::= quoted ASCII string
:HARDcopy:NETWork:SLO T <slot> (see page 443)	:HARDcopy:NETWork:SLO T? (see page 443)	<slot> ::= {NET0 NET1}
:HARDcopy:NETWork:USE Rname <username> (see page 444)	:HARDcopy:NETWork:USE Rname? (see page 444)	<username> ::= quoted ASCII string
:HARDcopy:PALETTE <palette> (see page 445)	:HARDcopy:PALETTE? (see page 445)	<palette> ::= {COLor GRAYscale NONE}

Table 16 :HARDcopy Commands Summary (continued)

Command	Query	Options and Query Returns
n/a	:HARDcopy:PRINter:LIST? (see page 446)	<pre><list> ::= [<printer_spec>] ... [printer_spec] <printer_spec> ::= "<index>,<active>,<name>;" <index> ::= integer index of printer <active> ::= {Y N} <name> ::= name of printer</pre>
:HARDcopy:START (see page 447)	n/a	n/a

Table 17 :LISTer Commands Summary

Command	Query	Options and Query Returns
n/a	:LISTer:DATA? (see page 450)	<pre><binary_block> ::= comma-separated data with newlines at the end of each row</pre>
:LISTer:DISPlay { {OFF 0} {SBUS1 ON 1} {SBUS2 2} ALL } (see page 451)	:LISTer:DISPlay? (see page 451)	{OFF SBUS1 SBUS2 ALL}
:LISTer:REFErence <time_ref> (see page 452)	:LISTer:REFErence? (see page 452)	<pre><time_ref> ::= {TRIGger PREVIOUS}</pre>

Table 18 :MARKer Commands Summary

Command	Query	Options and Query Returns
n/a	:MARKer:DYDX? (see page 456)	<pre><return_value> ::= •Y/•X value in NR3 format</pre>
:MARKer:MODE <mode> (see page 457)	:MARKer:MODE? (see page 457)	<pre><mode> ::= {OFF MEASurement MANual WAVeform BINary HEX}</pre>
:MARKer:X1:DISPlay { {0 OFF} {1 ON} } (see page 458)	:MARKer:X1:DISPlay? (see page 458)	<pre><setting> ::= {0 1}</pre>
:MARKer:X1Position <position>[suffix] (see page 459)	:MARKer:X1Position? (see page 459)	<pre><position> ::= X1 cursor position value in NR3 format [suffix] ::= {s ms us ns ps Hz kHz MHz} <return_value> ::= X1 cursor position value in NR3 format</pre>

Table 18 :MARKer Commands Summary (continued)

Command	Query	Options and Query Returns
:MARKer:X1Y1source <source> (see page 460)	:MARKer:X1Y1source? (see page 460)	<source> ::= {CHANnel<n> FUNctIon<m> MATH<m> WMEMory<r>} <n> ::= 1 to (# analog channels) in NR1 format <m> ::= 1 to (# math functions) in NR1 format <r> ::= 1 to (# ref waveforms) in NR1 format <return_value> ::= <source>
:MARKer:X2:DISPlay {0 OFF} {1 ON} (see page 461)	:MARKer:X2:DISPlay? (see page 461)	<setting> ::= {0 1}
:MARKer:X2Position <position>[suffix] (see page 462)	:MARKer:X2Position? (see page 462)	<position> ::= X2 cursor position value in NR3 format [suffix] ::= {s ms us ns ps Hz kHz MHz} <return_value> ::= X2 cursor position value in NR3 format
:MARKer:X2Y2source <source> (see page 463)	:MARKer:X2Y2source? (see page 463)	<source> ::= {CHANnel<n> FUNctIon<m> MATH<m> WMEMory<r>} <n> ::= 1 to (# analog channels) in NR1 format <m> ::= 1 to (# math functions) in NR1 format <r> ::= 1 to (# ref waveforms) in NR1 format <return_value> ::= <source>
n/a	:MARKer:XDELta? (see page 464)	<return_value> ::= X cursors delta value in NR3 format
:MARKer:XUNits <mode> (see page 465)	:MARKer:XUNits? (see page 465)	<units> ::= {SECOnds HERTz DEGREes PERCent}
:MARKer:XUNits:USE (see page 466)	n/a	n/a
:MARKer:Y1:DISPlay {0 OFF} {1 ON} (see page 467)	:MARKer:Y1:DISPlay? (see page 467)	<setting> ::= {0 1}

Table 18 :MARKer Commands Summary (continued)

Command	Query	Options and Query Returns
:MARKer:Y1Position <position>[suffix] (see page 468)	:MARKer:Y1Position? (see page 468)	<position> ::= Y1 cursor position value in NR3 format [suffix] ::= {V mV dB} <return_value> ::= Y1 cursor position value in NR3 format
:MARKer:Y2:DISPlay { {0 OFF} {1 ON} } (see page 469)	:MARKer:Y2:DISPlay? (see page 469)	<setting> ::= {0 1}
:MARKer:Y2Position <position>[suffix] (see page 470)	:MARKer:Y2Position? (see page 470)	<position> ::= Y2 cursor position value in NR3 format [suffix] ::= {V mV dB} <return_value> ::= Y2 cursor position value in NR3 format
n/a	:MARKer:YDELta? (see page 471)	<return_value> ::= Y cursors delta value in NR3 format
:MARKer:YUNits <mode> (see page 472)	:MARKer:YUNits? (see page 472)	<units> ::= {BASE PERCent}
:MARKer:YUNits:USE (see page 473)	n/a	n/a

Table 19 :MEASure Commands Summary

Command	Query	Options and Query Returns
:MEASure:ALL (see page 492)	n/a	n/a
:MEASure:AREa [<interval>][,<source>] (see page 493)	:MEASure:AREa? [<interval>][,<source>] (see page 493)	<interval> ::= {CYCLE DISPlay} <source> ::= {CHANnel<n> FUNCTION<m> MATH<m> WMemory<r>} <n> ::= 1 to (# analog channels) in NR1 format <m> ::= 1 to (# math functions) in NR1 format <r> ::= 1 to (# ref waveforms) in NR1 format <return_value> ::= area in volt-seconds, NR3 format

Table 19 :MEASure Commands Summary (continued)

Command	Query	Options and Query Returns
:MEASure:BRATe [<source>] (see page 494)	:MEASure:BRATe? [<source>] (see page 494)	<source> ::= {<digital channels> CHANnel<n> FUNCTion<m> MATH<m> WMEMory<r>} <digital channels> ::= DIGital<d> for the MSO models <d> ::= 0 to (# digital channels - 1) in NR1 format <n> ::= 1 to (# of analog channels) in NR1 format <m> ::= 1 to (# math functions) in NR1 format <r> ::= 1 to (# ref waveforms) in NR1 format <return_value> ::= bit rate in Hz, NR3 format
:MEASure:BWIDth [<source>] (see page 495)	:MEASure:BWIDth? [<source>] (see page 495)	<source> ::= {CHANnel<n> FUNCTion<m> MATH<m> WMEMory<r>} <n> ::= 1 to (# analog channels) in NR1 format <m> ::= 1 to (# math functions) in NR1 format <r> ::= 1 to (# ref waveforms) in NR1 format <return_value> ::= burst width in seconds, NR3 format
:MEASure:CLEAr (see page 496)	n/a	n/a
:MEASure:COUNter [<source>] (see page 497)	:MEASure:COUNter? [<source>] (see page 497)	<source> ::= {CHANnel<n> EXTernal} for DSO models <source> ::= {CHANnel<n> DIGital<d> EXTernal} for MSO models <n> ::= 1 to (# analog channels) in NR1 format <d> ::= 0 to (# digital channels - 1) in NR1 format <return_value> ::= counter frequency in Hertz in NR3 format

Table 19 :MEASure Commands Summary (continued)

Command	Query	Options and Query Returns
:MEASure:DEFine DElay, <delay spec> (see page 499)	:MEASure:DEFine? DElay (see page 501)	<delay spec> ::= <edge_spec1>,<edge_spec2> edge_spec1 ::= [<slope>]<occurrence> edge_spec2 ::= [<slope>]<occurrence> <slope> ::= {+ -} <occurrence> ::= integer
:MEASure:DEFine THResholds, <threshold spec> (see page 499)	:MEASure:DEFine? THResholds (see page 501)	<threshold spec> ::= {STANdard} {<threshold mode>,<upper>, <middle>,<lower>} <threshold mode> ::= {PERCent ABSolute}
:MEASure:DElay [<source1>] [,<source2>] (see page 502)	:MEASure:DElay? [<source1>] [,<source2>] (see page 502)	<source1,2> ::= {CHANnel<n> FUNctIon<m> MATH<m> WMEMory<r>} <n> ::= 1 to (# analog channels) in NR1 format <m> ::= 1 to (# math functions) in NR1 format <r> ::= 1 to (# ref waveforms) in NR1 format <return_value> ::= floating-point number delay time in seconds in NR3 format
:MEASure:DUAL:CHARge [<interval>] [,<source1>] [,<source 2>] (see page 504)	:MEASure:DUAL:CHARge? [<interval>] [,<source1>] [,<source 2>] (see page 504)	<interval> ::= {CYCLE DISPlay} <source1>,<source2> ::= CHANnel<n> with N2820A probe connected} <n> ::= 1 to (# analog channels) in NR1 format <return_value> ::= area in Amp-hours, NR3 format
:MEASure:DUAL:VAMPLit ude [<source1>] [,<source2 >] (see page 505)	:MEASure:DUAL:VAMPLit ude? [<source1>] [,<source2 >] (see page 505)	<source1>,<source2> ::= CHANnel<n> with N2820A probe connected <n> ::= 1 to (# analog channels) in NR1 format <return_value> ::= the amplitude of the selected waveform in volts in NR3 format

Table 19 :MEASure Commands Summary (continued)

Command	Query	Options and Query Returns
:MEASure:DUAL:VAverage [<interval>] [, <source1>] [, <source2>] (see page 506)	:MEASure:DUAL:VAverage? [<interval>] [, <source1>] [, <source2>] (see page 506)	<interval> ::= {CYCLE DISPLAY} <source1>, <source2> ::= CHANNEL<n> with N2820A probe connected <n> ::= 1 to (# analog channels) in NR1 format <return_value> ::= calculated average voltage in NR3 format
:MEASure:DUAL:VBASE [<source1>] [, <source2>] (see page 507)	:MEASure:DUAL:VBASE? [<source1>] [, <source2>] (see page 507)	<source1>, <source2> ::= CHANNEL<n> with N2820A probe connected <n> ::= 1 to (# analog channels) in NR1 format <base_voltage> ::= voltage at the base of the selected waveform in NR3 format
:MEASure:DUAL:VPP [<source1>] [, <source2>] (see page 508)	:MEASure:DUAL:VPP? [<source1>] [, <source2>] (see page 508)	<source1>, <source2> ::= CHANNEL<n> with N2820A probe connected <n> ::= 1 to (# analog channels) in NR1 format <return_value> ::= voltage peak-to-peak of the selected waveform in NR3 format
:MEASure:DUAL:VRMS [<interval>] [, <type>] [, <source1>] [, <source2>] (see page 509)	:MEASure:DUAL:VRMS? [<interval>] [, <type>] [, <source1>] [, <source2>] (see page 509)	<interval> ::= {CYCLE DISPLAY} <type> ::= {AC DC} <source1>, <source2> ::= CHANNEL<n> with N2820A probe connected <n> ::= 1 to (# analog channels) in NR1 format <return_value> ::= calculated RMS voltage in NR3 format

Table 19 :MEASure Commands Summary (continued)

Command	Query	Options and Query Returns
:MEASure:DUTYcycle [<source>] (see page 510)	:MEASure:DUTYcycle? [<source>] (see page 510)	<p><source> ::= {CHANnel<n> FUNCTION<m> MATH<m> WMemory<r>} for DSO models</p> <p><source> ::= {CHANnel<n> DIGital<d> FUNCTION<m> MATH<m> WMemory<r>} for MSO models</p> <p><n> ::= 1 to (# analog channels) in NR1 format</p> <p><m> ::= 1 to (# math functions) in NR1 format</p> <p><r> ::= 1 to (# ref waveforms) in NR1 format</p> <p><d> ::= 0 to (# digital channels - 1) in NR1 format</p> <p><return_value> ::= ratio of positive pulse width to period in NR3 format</p>
:MEASure:FALLtime [<source>] (see page 511)	:MEASure:FALLtime? [<source>] (see page 511)	<p><source> ::= {CHANnel<n> FUNCTION<m> MATH<m> WMemory<r>} for DSO models</p> <p><source> ::= {CHANnel<n> DIGital<d> FUNCTION<m> MATH<m> WMemory<r>} for MSO models</p> <p><n> ::= 1 to (# analog channels) in NR1 format</p> <p><m> ::= 1 to (# math functions) in NR1 format</p> <p><r> ::= 1 to (# ref waveforms) in NR1 format</p> <p><d> ::= 0 to (# digital channels - 1) in NR1 format</p> <p><return_value> ::= time in seconds between the lower and upper thresholds in NR3 format</p>

Table 19 :MEASure Commands Summary (continued)

Command	Query	Options and Query Returns
:MEASure:FREQuency [<source>] (see page 512)	:MEASure:FREQuency? [<source>] (see page 512)	<source> ::= {CHANnel<n> FUNctIon<m> MATH<m> WMEMory<r>} for DSO models <source> ::= {CHANnel<n> DIGital<d> FUNctIon<m> MATH<m> WMEMory<r>} for MSO models <n> ::= 1 to (# analog channels) in NR1 format <m> ::= 1 to (# math functions) in NR1 format <r> ::= 1 to (# ref waveforms) in NR1 format <d> ::= 0 to (# digital channels - 1) in NR1 format <return_value> ::= frequency in Hertz in NR3 format
:MEASure:NDUTy [<source>] (see page 513)	:MEASure:NDUTy? [<source>] (see page 513)	<source> ::= {CHANnel<n> FUNctIon<m> MATH<m> WMEMory<r>} for DSO models <source> ::= {CHANnel<n> DIGital<d> FUNctIon<m> MATH<m> WMEMory<r>} for MSO models <n> ::= 1 to (# analog channels) in NR1 format <m> ::= 1 to (# math functions) in NR1 format <r> ::= 1 to (# ref waveforms) in NR1 format <d> ::= 0 to (# digital channels - 1) in NR1 format <return_value> ::= ratio of negative pulse width to period in NR3 format
:MEASure:NEDGes [<source>] (see page 514)	:MEASure:NEDGes? [<source>] (see page 514)	<source> ::= {CHANnel<n> FUNctIon<m> MATH<m> WMEMory<r>} <n> ::= 1 to (# analog channels) in NR1 format <m> ::= 1 to (# math functions) in NR1 format <r> ::= 1 to (# ref waveforms) in NR1 format <return_value> ::= the falling edge count in NR3 format

Table 19 :MEASure Commands Summary (continued)

Command	Query	Options and Query Returns
:MEASure:NPULses [<source>] (see page 515)	:MEASure:NPULses? [<source>] (see page 515)	<source> ::= {CHANnel<n> FUNctIon<m> MATH<m> WMEMory<r>} <n> ::= 1 to (# analog channels) in NR1 format <m> ::= 1 to (# math functions) in NR1 format <r> ::= 1 to (# ref waveforms) in NR1 format <return_value> ::= the falling pulse count in NR3 format
:MEASure:NWIDth [<source>] (see page 516)	:MEASure:NWIDth? [<source>] (see page 516)	<source> ::= {CHANnel<n> FUNctIon<m> MATH<m> WMEMory<r>} for DSO models <source> ::= {CHANnel<n> DIGital<d> FUNctIon<m> MATH<m> WMEMory<r>} for MSO models <n> ::= 1 to (# analog channels) in NR1 format <m> ::= 1 to (# math functions) in NR1 format <r> ::= 1 to (# ref waveforms) in NR1 format <d> ::= 0 to (# digital channels - 1) in NR1 format <return_value> ::= negative pulse width in seconds-NR3 format
:MEASure:OVERshoot [<source>] (see page 517)	:MEASure:OVERshoot? [<source>] (see page 517)	<source> ::= {CHANnel<n> FUNctIon<m> MATH<m> WMEMory<r>} <n> ::= 1 to (# analog channels) in NR1 format <m> ::= 1 to (# math functions) in NR1 format <r> ::= 1 to (# ref waveforms) in NR1 format <return_value> ::= the percent of the overshoot of the selected waveform in NR3 format

Table 19 :MEASure Commands Summary (continued)

Command	Query	Options and Query Returns
:MEASure:PEDGes [<source>] (see page 519)	:MEASure:PEDGes? [<source>] (see page 519)	<source> ::= {CHANnel<n> FUNctIon<m> MATH<m> WMEMory<r>} <n> ::= 1 to (# analog channels) in NR1 format <m> ::= 1 to (# math functions) in NR1 format <r> ::= 1 to (# ref waveforms) in NR1 format <return_value> ::= the rising edge count in NR3 format
:MEASure:PERiod [<source>] (see page 520)	:MEASure:PERiod? [<source>] (see page 520)	<source> ::= {CHANnel<n> FUNctIon<m> MATH<m> WMEMory<r>} for DSO models <source> ::= {CHANnel<n> DIGital<d> FUNctIon<m> MATH<m> WMEMory<r>} for MSO models <n> ::= 1 to (# analog channels) in NR1 format <m> ::= 1 to (# math functions) in NR1 format <r> ::= 1 to (# ref waveforms) in NR1 format <d> ::= 0 to (# digital channels - 1) in NR1 format <return_value> ::= waveform period in seconds in NR3 format
:MEASure:PHASe [<source1>] [,<source2>] (see page 521)	:MEASure:PHASe? [<source1>] [,<source2>] (see page 521)	<source1,2> ::= {CHANnel<n> FUNctIon<m> MATH<m> WMEMory<r>} <n> ::= 1 to (# analog channels) in NR1 format <m> ::= 1 to (# math functions) in NR1 format <r> ::= 1 to (# ref waveforms) in NR1 format <return_value> ::= the phase angle value in degrees in NR3 format

Table 19 :MEASure Commands Summary (continued)

Command	Query	Options and Query Returns
:MEASure:PPULses [<source>] (see page 522)	:MEASure:PPULses? [<source>] (see page 522)	<source> ::= {CHANnel<n> FUNctIon<m> MATH<m> WMEMory<r>} <n> ::= 1 to (# analog channels) in NR1 format <m> ::= 1 to (# math functions) in NR1 format <r> ::= 1 to (# ref waveforms) in NR1 format <return_value> ::= the rising pulse count in NR3 format
:MEASure:PREShoot [<source>] (see page 523)	:MEASure:PREShoot? [<source>] (see page 523)	<source> ::= {CHANnel<n> FUNctIon<m> MATH<m> WMEMory<r>} <n> ::= 1 to (# analog channels) in NR1 format <m> ::= 1 to (# math functions) in NR1 format <r> ::= 1 to (# ref waveforms) in NR1 format <return_value> ::= the percent of preshoot of the selected waveform in NR3 format
:MEASure:PWIDth [<source>] (see page 524)	:MEASure:PWIDth? [<source>] (see page 524)	<source> ::= {CHANnel<n> FUNctIon<m> MATH<m> WMEMory<r>} for DSO models <source> ::= {CHANnel<n> DIGital<d> FUNctIon<m> MATH<m> WMEMory<r>} for MSO models <n> ::= 1 to (# analog channels) in NR1 format <m> ::= 1 to (# math functions) in NR1 format <r> ::= 1 to (# ref waveforms) in NR1 format <d> ::= 0 to (# digital channels - 1) in NR1 format <return_value> ::= width of positive pulse in seconds in NR3 format
n/a	:MEASure:RESults? <result_list> (see page 525)	<result_list> ::= comma-separated list of measurement results

Table 19 :MEASure Commands Summary (continued)

Command	Query	Options and Query Returns
:MEASure:RISetime [<source>] (see page 528)	:MEASure:RISetime? [<source>] (see page 528)	<source> ::= {CHANnel<n> FUNctIon<m> MATH<m> WMEMory<r>} <n> ::= 1 to (# analog channels) in NR1 format <m> ::= 1 to (# math functions) in NR1 format <r> ::= 1 to (# ref waveforms) in NR1 format <return_value> ::= rise time in seconds in NR3 format
:MEASure:SDEVIation [<source>] (see page 529)	:MEASure:SDEVIation? [<source>] (see page 529)	<source> ::= {CHANnel<n> FUNctIon<m> MATH<m> WMEMory<r>} <n> ::= 1 to (# analog channels) in NR1 format <m> ::= 1 to (# math functions) in NR1 format <r> ::= 1 to (# ref waveforms) in NR1 format <return_value> ::= calculated std deviation in NR3 format
:MEASure:SHOW {{0 OFF} {1 ON}} (see page 530)	:MEASure:SHOW? (see page 530)	{0 1}
:MEASure:SOURce <source1> [,<source2>] (see page 531)	:MEASure:SOURce? (see page 531)	<source1,2> ::= {CHANnel<n> FUNctIon<m> MATH<m> WMEMory<r> EXTErnal} for DSO models <source1,2> ::= {CHANnel<n> DIGital<d> FUNctIon<m> MATH<m> WMEMory<r> EXTErnal} for MSO models <n> ::= 1 to (# analog channels) in NR1 format <m> ::= 1 to (# math functions) in NR1 format <r> ::= 1 to (# ref waveforms) in NR1 format <d> ::= 0 to (# digital channels - 1) in NR1 format <return_value> ::= {<source> NONE}

Table 19 :MEASure Commands Summary (continued)

Command	Query	Options and Query Returns
:MEASure:STATistics <type> (see page 533)	:MEASure:STATistics? (see page 533)	<type> ::= {{ON 1} CURRENT MEAN MINimum MAXimum STDDev COUNT} ON ::= all statistics returned
:MEASure:STATistics:D ISPlay {{0 OFF} {1 ON}} (see page 534)	:MEASure:STATistics:D ISPlay? (see page 534)	{0 1}
:MEASure:STATistics:I NCRement (see page 535)	n/a	n/a
:MEASure:STATistics:M COUNt <setting> (see page 536)	:MEASure:STATistics:M COUNt? (see page 536)	<setting> ::= {INFinite <count>} <count> ::= 2 to 2000 in NR1 format
:MEASure:STATistics:R ESet (see page 537)	n/a	n/a
:MEASure:STATistics:R SDeviatiOn {{0 OFF} {1 ON}} (see page 538)	:MEASure:STATistics:R SDeviatiOn? (see page 538)	{0 1}
n/a	:MEASure:TEDGe? <slope><occurrence>[, <source>] (see page 539)	<slope> ::= direction of the waveform <occurrence> ::= the transition to be reported <source> ::= {CHANnel<n> FUNCTION<m> MATH<m> WMemory<r>} for DSO models <source> ::= {CHANnel<n> DIGital<d> FUNCTION<m> MATH<m> WMemory<r>} for MSO models <n> ::= 1 to (# analog channels) in NR1 format <m> ::= 1 to (# math functions) in NR1 format <r> ::= 1 to (# ref waveforms) in NR1 format <d> ::= 0 to (# digital channels - 1) in NR1 format <return_value> ::= time in seconds of the specified transition

Table 19 :MEASure Commands Summary (continued)

Command	Query	Options and Query Returns
n/a	:MEASure:TVALue? <value>, [<slope>]<occurrence> [,<source>] (see page 541)	<value> ::= voltage level that the waveform must cross. <slope> ::= direction of the waveform when <value> is crossed. <occurrence> ::= transitions reported. <source> ::= {CHANnel<n> FUNctIon<m> MATH<m> WMEMory<r>} for DSO models <source> ::= {CHANnel<n> DIGital<d> FUNctIon<m> MATH<m> WMEMory<r>} for MSO models <n> ::= 1 to (# analog channels) in NR1 format <m> ::= 1 to (# math functions) in NR1 format <r> ::= 1 to (# ref waveforms) in NR1 format <d> ::= 0 to (# digital channels - 1) in NR1 format <return_value> ::= time in seconds of specified voltage crossing in NR3 format
:MEASure:VAMplitude [<source>] (see page 543)	:MEASure:VAMplitude? [<source>] (see page 543)	<source> ::= {CHANnel<n> FUNctIon<m> MATH<m> WMEMory<r>} <n> ::= 1 to (# analog channels) in NR1 format <m> ::= 1 to (# math functions) in NR1 format <r> ::= 1 to (# ref waveforms) in NR1 format <return_value> ::= the amplitude of the selected waveform in volts in NR3 format

Table 19 :MEASure Commands Summary (continued)

Command	Query	Options and Query Returns
:MEASure:VAverage [<interval>] [, <source>] (see page 544)	:MEASure:VAverage? [<interval>] [, <source>] (see page 544)	<interval> ::= {CYCLE DISPLAY} <source> ::= {CHANNEL<n> FUNCTION<m> MATH<m> FFT WMEMORY<r>} <n> ::= 1 to (# analog channels) in NR1 format <m> ::= 1 to (# math functions) in NR1 format <r> ::= 1 to (# ref waveforms) in NR1 format <return_value> ::= calculated average voltage in NR3 format
:MEASure:VBASE [<source>] (see page 545)	:MEASure:VBASE? [<source>] (see page 545)	<source> ::= {CHANNEL<n> FUNCTION<m> MATH<m> WMEMORY<r>} <n> ::= 1 to (# analog channels) in NR1 format <m> ::= 1 to (# math functions) in NR1 format <r> ::= 1 to (# ref waveforms) in NR1 format <base_voltage> ::= voltage at the base of the selected waveform in NR3 format
:MEASure:VMAX [<source>] (see page 546)	:MEASure:VMAX? [<source>] (see page 546)	<source> ::= {CHANNEL<n> FUNCTION<m> FFT MATH<m> WMEMORY<r>} <n> ::= 1 to (# analog channels) in NR1 format <m> ::= 1 to (# math functions) in NR1 format <r> ::= 1 to (# ref waveforms) in NR1 format <return_value> ::= maximum voltage of the selected waveform in NR3 format

Table 19 :MEASure Commands Summary (continued)

Command	Query	Options and Query Returns
:MEASure:VMIN [<source>] (see page 547)	:MEASure:VMIN? [<source>] (see page 547)	<source> ::= {CHANnel<n> FUNctIon<m> FFT MATH<m> WMEMory<r>} <n> ::= 1 to (# analog channels) in NR1 format <m> ::= 1 to (# math functions) in NR1 format <r> ::= 1 to (# ref waveforms) in NR1 format <return_value> ::= minimum voltage of the selected waveform in NR3 format
:MEASure:VPP [<source>] (see page 548)	:MEASure:VPP? [<source>] (see page 548)	<source> ::= {CHANnel<n> FUNctIon<m> FFT MATH<m> WMEMory<r>} <n> ::= 1 to (# analog channels) in NR1 format <m> ::= 1 to (# math functions) in NR1 format <r> ::= 1 to (# ref waveforms) in NR1 format <return_value> ::= voltage peak-to-peak of the selected waveform in NR3 format
:MEASure:VRATio [<interval>] [,<source 1>] [,<source2>] (see page 549)	:MEASure:VRATio? [<interval>] [,<source 1>] [,<source2>] (see page 549)	<interval> ::= {CYCLe DISPlay} <source1,2> ::= {CHANnel<n> FUNctIon<m> MATH<m> WMEMory<r>} <n> ::= 1 to (# analog channels) in NR1 format <m> ::= 1 to (# math functions) in NR1 format <r> ::= 1 to (# ref waveforms) in NR1 format <return_value> ::= the ratio value in dB in NR3 format

Table 19 :MEASure Commands Summary (continued)

Command	Query	Options and Query Returns
:MEASure:VRMS [<interval>] [, <type>] [, <source>] (see page 550)	:MEASure:VRMS? [<interval>] [, <type>] [, <source>] (see page 550)	<interval> ::= {CYCLE DISPLAY} <type> ::= {AC DC} <source> ::= {CHANnel<n> FUNctIon<m> MATH<m> WMEMory<r>} <n> ::= 1 to (# analog channels) in NR1 format <m> ::= 1 to (# math functions) in NR1 format <r> ::= 1 to (# ref waveforms) in NR1 format <return_value> ::= calculated dc RMS voltage in NR3 format
n/a	:MEASure:VTIME? <vtime> [, <source>] (see page 551)	<vtime> ::= displayed time from trigger in seconds in NR3 format <source> ::= {CHANnel<n> FUNctIon<m> MATH<m> WMEMory<r>} for DSO models <source> ::= {CHANnel<n> DIGital<d> FUNctIon<m> MATH<m> WMEMory<r>} for MSO models <n> ::= 1 to (# analog channels) in NR1 format <m> ::= 1 to (# math functions) in NR1 format <r> ::= 1 to (# ref waveforms) in NR1 format <d> ::= 0 to (# digital channels - 1) in NR1 format <return_value> ::= voltage at the specified time in NR3 format
:MEASure:VTOP [<source>] (see page 552)	:MEASure:VTOP? [<source>] (see page 552)	<source> ::= {CHANnel<n> FUNctIon<m> MATH<m> WMEMory<r>} <n> ::= 1 to (# analog channels) in NR1 format <m> ::= 1 to (# math functions) in NR1 format <r> ::= 1 to (# ref waveforms) in NR1 format <return_value> ::= voltage at the top of the waveform in NR3 format
:MEASure:WINDow <type> (see page 553)	:MEASure:WINDow? (see page 553)	<type> ::= {MAIN ZOOM AUTO GATE}

Table 19 :MEASure Commands Summary (continued)

Command	Query	Options and Query Returns
:MEASure:XMAX [<source>] (see page 554)	:MEASure:XMAX? [<source>] (see page 554)	<source> ::= {CHANnel<n> FUNctIon<m> FFT MATH<m> WMEMory<r>} <n> ::= 1 to (# analog channels) in NR1 format <m> ::= 1 to (# math functions) in NR1 format <r> ::= 1 to (# ref waveforms) in NR1 format <return_value> ::= horizontal value of the maximum in NR3 format
:MEASure:XMIN [<source>] (see page 555)	:MEASure:XMIN? [<source>] (see page 555)	<source> ::= {CHANnel<n> FUNctIon<m> FFT MATH<m> WMEMory<r>} <n> ::= 1 to (# analog channels) in NR1 format <m> ::= 1 to (# math functions) in NR1 format <r> ::= 1 to (# ref waveforms) in NR1 format <return_value> ::= horizontal value of the maximum in NR3 format

Table 20 :MEASure Power Commands Summary

Command	Query	Options and Query Returns
:MEASure:ANGLE [<source1>] [, <source2 >] (see page 561)	:MEASure:ANGLE? [<source1>] [, <source2 >] (see page 561)	<source1>, <source2> ::= {CHANnel<n>} <n> ::= 1 to (# analog channels) in NR1 format <return_value> ::= the power phase angle in degrees in NR3 format
:MEASure:APParent [<source1>] [, <source2 >] (see page 562)	:MEASure:APParent? [<source1>] [, <source2 >] (see page 562)	<source1>, <source2> ::= {CHANnel<n>} <n> ::= 1 to (# analog channels) in NR1 format <return_value> ::= the apparent power value in NR3 format

Table 20 :MEASure Power Commands Summary (continued)

Command	Query	Options and Query Returns
:MEASure:CPLoss [<source1>] [, <source2>] (see page 563)	:MEASure:CPLoss? [<source1>] [, <source2>] (see page 563)	<source1>, <source2> <source1> ::= {FUNCTION<m> MATH<m>} <source2> ::= {CHANnel<n>} <m> ::= 1 to (# math functions) in NR1 format <n> ::= 1 to (# analog channels) in NR1 format <return_value> ::= the switching loss per cycle watts value in NR3 format
:MEASure:CRESt [<source>] (see page 564)	:MEASure:CRESt? [<source>] (see page 564)	<source> ::= {CHANnel<n> FUNCTION<m> MATH<m>} <n> ::= 1 to (# analog channels) in NR1 format <m> ::= 1 to (# math functions) in NR1 format <return_value> ::= the crest factor value in NR3 format
:MEASure:EFFiciency (see page 565)	:MEASure:EFFiciency? (see page 565)	<return_value> ::= percent value in NR3 format
:MEASure:ELOSSs [<source>] (see page 566)	:MEASure:ELOSSs? [<source>] (see page 566)	<source> ::= {CHANnel<n> FUNCTION<m> MATH<m> WMemory<r>} <n> ::= 1 to (# analog channels) in NR1 format <m> ::= 1 to (# math functions) in NR1 format <r> ::= 1 to (# ref waveforms) in NR1 format <return_value> ::= the energy loss value in NR3 format
:MEASure:FACTOR [<source1>] [, <source2>] (see page 567)	:MEASure:FACTOR? [<source1>] [, <source2>] (see page 567)	<source1>, <source2> ::= {CHANnel<n>} <n> ::= 1 to (# analog channels) in NR1 format <return_value> ::= the power factor value in NR3 format
:MEASure:IPower (see page 568)	:MEASure:IPower? (see page 568)	<return_value> ::= the input power value in NR3 format

Table 20 :MEASure Power Commands Summary (continued)

Command	Query	Options and Query Returns
:MEASure:OFFTime [<source1>] [, <source2>] >] (see page 569)	:MEASure:OFFTime? [<source1>] [, <source2>] >] (see page 569)	<source1>, <source2> ::= {CHANnel<n>} <n> ::= 1 to (# analog channels) in NR1 format <return_value> ::= the time in seconds in NR3 format
:MEASure:ONTime [<source1>] [, <source2>] >] (see page 570)	:MEASure:ONTime? [<source1>] [, <source2>] >] (see page 570)	<source1>, <source2> ::= {CHANnel<n>} <n> ::= 1 to (# analog channels) in NR1 format <return_value> ::= the time in seconds in NR3 format
:MEASure:OPower (see page 571)	:MEASure:OPower? (see page 571)	<return_value> ::= the output power value in NR3 format
:MEASure:PCurrent [<source>] (see page 572)	:MEASure:PCurrent? [<source>] (see page 572)	<source> ::= {CHANnel<n> FUNCTION<m> MATH<m> WMemory<r>} <n> ::= 1 to (# analog channels) in NR1 format <m> ::= 1 to (# math functions) in NR1 format <r> ::= 1 to (# ref waveforms) in NR1 format <return_value> ::= the peak current value in NR3 format
:MEASure:PLOss [<source>] (see page 573)	:MEASure:PLOss? [<source>] (see page 573)	<source> ::= {CHANnel<n> FUNCTION<m> MATH<m> WMemory<r>} <n> ::= 1 to (# analog channels) in NR1 format <m> ::= 1 to (# math functions) in NR1 format <r> ::= 1 to (# ref waveforms) in NR1 format <return_value> ::= the power loss value in NR3 format

Table 20 :MEASure Power Commands Summary (continued)

Command	Query	Options and Query Returns
:MEASure:RDson [<source1>] [, <source2>] >] (see page 574)	:MEASure:RDson? [<source1>] [, <source2>] >] (see page 574)	<source1>, <source2> ::= {CHANnel<n> FUNCTION<m> MATH<m> WMemory<r>} <n> ::= 1 to (# analog channels) in NR1 format <m> ::= 1 to (# math functions) in NR1 format <r> ::= 1 to (# ref waveforms) in NR1 format <return_value> ::= the VCE(sat) value in NR3 format
:MEASure:REACTive [<source1>] [, <source2>] >] (see page 575)	:MEASure:REACTive? [<source1>] [, <source2>] >] (see page 575)	<source1>, <source2> ::= {CHANnel<n>} <n> ::= 1 to (# analog channels) in NR1 format <return_value> ::= the reactive power value in NR3 format
:MEASure:REAL [<source>] (see page 576)	:MEASure:REAL? [<source>] (see page 576)	<source> ::= {CHANnel<n> FUNCTION<m> MATH<m>} <n> ::= 1 to (# analog channels) in NR1 format <m> ::= 1 to (# math functions) in NR1 format <return_value> ::= the real power value in NR3 format
:MEASure:RIPple [<source>] (see page 577)	:MEASure:RIPple? [<source>] (see page 577)	<source> ::= {CHANnel<n> FUNCTION<m> MATH<m> WMemory<r>} <n> ::= 1 to (# analog channels) in NR1 format <m> ::= 1 to (# math functions) in NR1 format <r> ::= 1 to (# ref waveforms) in NR1 format <return_value> ::= the output ripple value in NR3 format

Table 20 :MEASure Power Commands Summary (continued)

Command	Query	Options and Query Returns
:MEASure:TRESponse [<source>] (see page 578)	:MEASure:TRESponse? [<source>] (see page 578)	<source> ::= {CHANnel<n> FUNctIon<m> MATH<m> WMEMory<r>} <n> ::= 1 to (# analog channels) in NR1 format <m> ::= 1 to (# math functions) in NR1 format <r> ::= 1 to (# ref waveforms) in NR1 format <return_value> ::= time in seconds for the overshoot to settle back into the band in NR3 format
:MEASure:VCESat [<source>] (see page 579)	:MEASure:VCESat? [<source>] (see page 579)	<source> ::= {CHANnel<n> FUNctIon<m> MATH<m> WMEMory<r>} <n> ::= 1 to (# analog channels) in NR1 format <m> ::= 1 to (# math functions) in NR1 format <r> ::= 1 to (# ref waveforms) in NR1 format <return_value> ::= the VCE(sat) value in NR3 format

Table 21 :MTEST Commands Summary

Command	Query	Options and Query Returns
:MTEST:ALL {{0 OFF} {1 ON}} (see page 586)	:MTEST:ALL? (see page 586)	{0 1}
:MTEST:AMASK:CREate (see page 587)	n/a	n/a
:MTEST:AMASK:SOURce <source> (see page 588)	:MTEST:AMASK:SOURce? (see page 588)	<source> ::= CHANnel<n> <n> ::= {1 2 3 4} for 4ch models <n> ::= {1 2} for 2ch models
:MTEST:AMASK:UNITs <units> (see page 589)	:MTEST:AMASK:UNITs? (see page 589)	<units> ::= {CURRent DIVisions}
:MTEST:AMASK:XDELta <value> (see page 590)	:MTEST:AMASK:XDELta? (see page 590)	<value> ::= X delta value in NR3 format

Table 21 :MTESt Commands Summary (continued)

Command	Query	Options and Query Returns
:MTESt:AMASk:YDELta <value> (see page 591)	:MTESt:AMASk:YDELta? (see page 591)	<value> ::= Y delta value in NR3 format
n/a	:MTESt:COUNT:FWAVEfor ms? [CHANnel<n>] (see page 592)	<failed> ::= number of failed waveforms in NR1 format
:MTESt:COUNT:RESet (see page 593)	n/a	n/a
n/a	:MTESt:COUNT:TIME? (see page 594)	<time> ::= elapsed seconds in NR3 format
n/a	:MTESt:COUNT:WAVEform s? (see page 595)	<count> ::= number of waveforms in NR1 format
:MTESt:DATA <mask> (see page 596)	:MTESt:DATA? (see page 596)	<mask> ::= data in IEEE 488.2 # format.
:MTESt:DELeTe (see page 597)	n/a	n/a
:MTESt:ENABLe {{0 OFF} {1 ON}} (see page 598)	:MTESt:ENABLe? (see page 598)	{0 1}
:MTESt:LOCK {{0 OFF} {1 ON}} (see page 599)	:MTESt:LOCK? (see page 599)	{0 1}
:MTESt:RMODE <rmode> (see page 600)	:MTESt:RMODE? (see page 600)	<rmode> ::= {FORever TIME SIGMa WAVEforms}
:MTESt:RMODE:FACTION: MEASure {{0 OFF} {1 ON}} (see page 601)	:MTESt:RMODE:FACTION: MEASure? (see page 601)	{0 1}
:MTESt:RMODE:FACTION: PRINt {{0 OFF} {1 ON}} (see page 602)	:MTESt:RMODE:FACTION: PRINt? (see page 602)	{0 1}
:MTESt:RMODE:FACTION: SAVE {{0 OFF} {1 ON}} (see page 603)	:MTESt:RMODE:FACTION: SAVE? (see page 603)	{0 1}
:MTESt:RMODE:FACTION: STOP {{0 OFF} {1 ON}} (see page 604)	:MTESt:RMODE:FACTION: STOP? (see page 604)	{0 1}
:MTESt:RMODE:SIGMa <level> (see page 605)	:MTESt:RMODE:SIGMa? (see page 605)	<level> ::= from 0.1 to 9.3 in NR3 format

Table 21 :MTEST Commands Summary (continued)

Command	Query	Options and Query Returns
:MTEST:RMODE:TIME <seconds> (see page 606)	:MTEST:RMODE:TIME? (see page 606)	<seconds> ::= from 1 to 86400 in NR3 format
:MTEST:RMODE:WAVEforms <count> (see page 607)	:MTEST:RMODE:WAVEforms? (see page 607)	<count> ::= number of waveforms in NR1 format
:MTEST:SCALE:BIND {{0 OFF}} {{1 ON}} (see page 608)	:MTEST:SCALE:BIND? (see page 608)	{0 1}
:MTEST:SCALE:X1 <x1_value> (see page 609)	:MTEST:SCALE:X1? (see page 609)	<x1_value> ::= X1 value in NR3 format
:MTEST:SCALE:XDELta <xdelta_value> (see page 610)	:MTEST:SCALE:XDELta? (see page 610)	<xdelta_value> ::= X delta value in NR3 format
:MTEST:SCALE:Y1 <y1_value> (see page 611)	:MTEST:SCALE:Y1? (see page 611)	<y1_value> ::= Y1 value in NR3 format
:MTEST:SCALE:Y2 <y2_value> (see page 612)	:MTEST:SCALE:Y2? (see page 612)	<y2_value> ::= Y2 value in NR3 format
:MTEST:SOURce <source> (see page 613)	:MTEST:SOURce? (see page 613)	<source> ::= {CHANNEL<n> NONE} <n> ::= {1 2 3 4} for 4ch models <n> ::= {1 2} for 2ch models
n/a	:MTEST:TITLe? (see page 614)	<title> ::= a string of up to 128 ASCII characters

Table 22 :POD<n> Commands Summary

Command	Query	Options and Query Returns
:POD<n>:DISPlay {{0 OFF}} {{1 ON}} (see page 617)	:POD<n>:DISPlay? (see page 617)	{0 1} <n> ::= 1-2 in NR1 format

Table 22 :POD<n> Commands Summary (continued)

Command	Query	Options and Query Returns
:POD<n>:SIZE <value> (see page 618)	:POD<n>:SIZE? (see page 618)	<value> ::= {SMALl MEDium LARGe}
:POD<n>:THReshold <type>[suffix] (see page 619)	:POD<n>:THReshold? (see page 619)	<n> ::= 1-2 in NR1 format <type> ::= {CMOS ECL TTL <user defined value>} <user defined value> ::= value in NR3 format [suffix] ::= {V mV uV }

Table 23 :POWer Commands Summary

Command	Query	Options and Query Returns
n/a	:POWer:CLResponse? (see page 628)	n/a
:POWer:CLResponse:APP Ly (see page 629)	n/a	n/a
n/a	:POWer:CLResponse:DAT A? (see page 630)	<binary_block> ::= comma-separated data with newlines at the end of each row
:POWer:CLResponse:FRE Quency:MODE <mode> (see page 631)	:POWer:CLResponse:FRE Quency:MODE? (see page 631)	<mode> ::= {SWEep SINGle}
:POWer:CLResponse:FRE Quency:START <value>[suffix] (see page 632)	:POWer:CLResponse:FRE Quency:START? (see page 632)	<value> ::= {20 100 1000 10000 100000 1000000 10000000} [suffix] ::= {Hz kHz MHz}
:POWer:CLResponse:FRE Quency:STOP <value>[suffix] (see page 633)	:POWer:CLResponse:FRE Quency:STOP? (see page 633)	<value> ::= {100 1000 10000 100000 1000000 10000000 20000000} [suffix] ::= {Hz kHz MHz}
:POWer:CLResponse:PPD ecade <pts> (see page 634)	:POWer:CLResponse:PPD ecade? (see page 634)	<pts> ::= {10 20 30 40 50}
:POWer:CLResponse:SOU Rce:INPut <source> (see page 635)	:POWer:CLResponse:SOU Rce:INPut? (see page 635)	<source> ::= CHANnel<n> <n> ::= 1 to (# analog channels) in NR1 format
:POWer:CLResponse:SOU Rce:OUTPut <source> (see page 636)	:POWer:CLResponse:SOU Rce:OUTPut? (see page 636)	<source> ::= CHANnel<n> <n> ::= 1 to (# analog channels) in NR1 format

Table 23 :POWer Commands Summary (continued)

Command	Query	Options and Query Returns
:POWer:CLResponse:WGEN:LOAD <impedance> (see page 637)	:POWer:CLResponse:WGEN:LOAD? (see page 637)	<impedance> ::= {ONEMeg FIFTy}
:POWer:CLResponse:WGEN:VOLTage <amplitude>[,<range>] (see page 638)	:POWer:CLResponse:WGEN:VOLTage? [<range>] (see page 638)	<amplitude> ::= amplitude in volts in NR3 format <range> ::= {F20HZ F100HZ F1KHZ F10KHZ F100KHZ F1MHZ F10MHZ F20MHZ}
:POWer:CLResponse:WGEN:VOLTage:PROFile {{0 OFF} {1 ON}} (see page 639)	:POWer:CLResponse:WGEN:VOLTage:PROFile? (see page 639)	{0 1}
:POWer:DESKew (see page 640)	n/a	n/a
:POWer:EFFiciency:APPLy (see page 641)	n/a	n/a
:POWer:EFFiciency:TYP E <type> (see page 642)	:POWer:EFFiciency:TYP E? (see page 642)	<type> ::= {DCDC DCAC ACDC ACAC}
:POWer:ENABLE {{0 OFF} {1 ON}} (see page 643)	:POWer:ENABLE? (see page 643)	{0 1}
:POWer:HARMonics:APPLy (see page 644)	n/a	n/a
n/a	:POWer:HARMonics:DATA? (see page 645)	<binary_block> ::= comma-separated data with newlines at the end of each row
:POWer:HARMonics:DISP lay <display> (see page 646)	:POWer:HARMonics:DISP lay? (see page 646)	<display> ::= {TABLE BAR OFF}
n/a	:POWer:HARMonics:FAIL count? (see page 647)	<count> ::= integer in NR1 format
:POWer:HARMonics:LINE <frequency> (see page 648)	:POWer:HARMonics:LINE? (see page 648)	<frequency> ::= {F50 F60 F400 AUTO}
n/a	:POWer:HARMonics:POWerfactor? (see page 649)	<value> ::= Class C power factor in NR3 format

Table 23 :POWer Commands Summary (continued)

Command	Query	Options and Query Returns
:POWer:HARMonics:RPOWer <source> (see page 650)	:POWer:HARMonics:RPOWer? (see page 650)	<source> ::= {MEASured USER}
:POWer:HARMonics:RPOWer:USER <value> (see page 651)	:POWer:HARMonics:RPOWer:USER? (see page 651)	<value> ::= Watts from 1.0 to 600.0 in NR3 format
n/a	:POWer:HARMonics:RUNCout? (see page 652)	<count> ::= integer in NR1 format
:POWer:HARMonics:STANdard <class> (see page 653)	:POWer:HARMonics:STANdard? (see page 653)	<class> ::= {A B C D}
n/a	:POWer:HARMonics:STATus? (see page 654)	<status> ::= {PASS FAIL UNTested}
n/a	:POWer:HARMonics:THD? (see page 655)	<value> ::= Total Harmonics Distortion in NR3 format
:POWer:INRush:APPLy (see page 656)	n/a	n/a
:POWer:INRush:EXIT (see page 657)	n/a	n/a
:POWer:INRush:NEXT (see page 658)	n/a	n/a
:POWer:ITYPE <type> (see page 659)	:POWer:ITYPE? (see page 659)	<type> ::= {DC AC}
:POWer:MODulation:APPLy (see page 660)	n/a	n/a
:POWer:MODulation:SOUrce <source> (see page 661)	:POWer:MODulation:SOUrce? (see page 661)	<source> ::= {V I}
:POWer:MODulation:TYP E <modulation> (see page 662)	:POWer:MODulation:TYP E? (see page 662)	<modulation> ::= {VAverage ACRMs VRATio PERiod FREQuency PWIDith NWIDth DUTYcycle RISetime FALLtime}
:POWer:ONOFF:APPLy (see page 663)	n/a	n/a
:POWer:ONOFF:EXIT (see page 664)	n/a	n/a
:POWer:ONOFF:NEXT (see page 665)	n/a	n/a

Table 23 :POWer Commands Summary (continued)

Command	Query	Options and Query Returns
:POWer:ONOff:TEST {{0 OFF} {1 ON}} (see page 666)	:POWer:ONOff:TEST? (see page 666)	{0 1}
:POWer:ONOff:THReshol ds <type>, <input_thr>, <output_thr> (see page 667)	:POWer:ONOff:THReshol ds? <type> (see page 667)	<type> ::= {0 1} <input_thr> ::= percent from 0-100 in NR1 format <output_thr> ::= percent from 0-100 in NR1 format
n/a	:POWer:PSRR? (see page 669)	n/a
:POWer:PSRR:APPLy (see page 670)	n/a	n/a
n/a	:POWer:PSRR:DATA? (see page 671)	<binary_block> ::= comma-separated data with newlines at the end of each row
:POWer:PSRR:FREQuency :MAXimum <value>[suffix] (see page 672)	:POWer:PSRR:FREQuency :MAXimum? (see page 672)	<value> ::= {10 100 1000 10000 100000 1000000 10000000 20000000} [suffix] ::= {Hz kHz MHz}
:POWer:PSRR:FREQuency :MINimum <value>[suffix] (see page 673)	:POWer:PSRR:FREQuency :MINimum? (see page 673)	<value> ::= {1 10 100 1000 10000 100000 1000000 10000000} [suffix] ::= {Hz kHz MHz}
:POWer:PSRR:FREQuency :MODE <mode> (see page 674)	:POWer:PSRR:FREQuency :MODE? (see page 674)	<mode> ::= {SWEep SINGLE}
:POWer:PSRR:PPDecade <pts> (see page 675)	:POWer:PSRR:PPDecade? (see page 675)	<pts> ::= {10 20 30 40 50}
:POWer:PSRR:SOURce:IN Put <source> (see page 676)	:POWer:PSRR:SOURce:IN Put? (see page 676)	<source> ::= CHANnel<n> <n> ::= 1 to (# analog channels) in NR1 format
:POWer:PSRR:SOURce:OU TPut <source> (see page 677)	:POWer:PSRR:SOURce:OU TPut? (see page 677)	<source> ::= CHANnel<n> <n> ::= 1 to (# analog channels) in NR1 format
:POWer:PSRR:WGEN:LOAD <impedance> (see page 678)	:POWer:PSRR:WGEN:LOAD ? (see page 678)	<impedance> ::= {ONEMeg FIFTy}

Table 23 :POWer Commands Summary (continued)

Command	Query	Options and Query Returns
:POWer:PSRR:WGEN:VOLT age <amplitude> [, <range>] (see page 679)	:POWer:PSRR:WGEN:VOLT age? [<range>] (see page 679)	<amplitude> ::= amplitude in volts in NR3 format <range> ::= {F20HZ F100HZ F1KHZ F10KHZ F100KHZ F1MHZ F10MHZ F20MHZ}
:POWer:PSRR:WGEN:VOLT age:PROFile {{0 OFF} {1 ON}} (see page 680)	:POWer:PSRR:WGEN:VOLT age:PROFile? (see page 680)	{0 1}
:POWer:QUALity:APPLy (see page 681)	n/a	n/a
:POWer:RIPPlE:APPLy (see page 682)	n/a	n/a
:POWer:SIGNals:AUTose tup <analysis> (see page 683)	n/a	<analysis> ::= {HARMonics EFFiciency RIPPlE MODulation QUALity SLEW SWITCh RDSVce}
:POWer:SIGNals:CYCLes :HARMonics <count> (see page 684)	:POWer:SIGNals:CYCLes :HARMonics? (see page 684)	<count> ::= integer in NR1 format Legal values are 1 to 100.
:POWer:SIGNals:CYCLes :QUALity <count> (see page 685)	:POWer:SIGNals:CYCLes :QUALity? (see page 685)	<count> ::= integer in NR1 format Legal values are 1 to 100.
:POWer:SIGNals:DURati on:EFFiciency <value> [suffix] (see page 686)	:POWer:SIGNals:DURati on:EFFiciency? (see page 686)	<value> ::= value in NR3 format [suffix] ::= {s ms us ns}
:POWer:SIGNals:DURati on:MODulation <value> [suffix] (see page 687)	:POWer:SIGNals:DURati on:MODulation? (see page 687)	<value> ::= value in NR3 format [suffix] ::= {s ms us ns}
:POWer:SIGNals:DURati on:ONOff:OFF <value> [suffix] (see page 688)	:POWer:SIGNals:DURati on:ONOff:OFF? (see page 688)	<value> ::= value in NR3 format [suffix] ::= {s ms us ns}
:POWer:SIGNals:DURati on:ONOff:ON <value> [suffix] (see page 689)	:POWer:SIGNals:DURati on:ONOff:ON? (see page 689)	<value> ::= value in NR3 format [suffix] ::= {s ms us ns}

Table 23 :POWer Commands Summary (continued)

Command	Query	Options and Query Returns
:POWer:SIGNals:DURati on:RIPple <value>[suffix] (see page 690)	:POWer:SIGNals:DURati on:RIPple? (see page 690)	<value> ::= value in NR3 format [suffix] ::= {s ms us ns}
:POWer:SIGNals:DURati on:TRANSient <value>[suffix] (see page 691)	:POWer:SIGNals:DURati on:TRANSient? (see page 691)	<value> ::= value in NR3 format [suffix] ::= {s ms us ns}
:POWer:SIGNals:IEXpec ted <value>[suffix] (see page 692)	:POWer:SIGNals:IEXpec ted? (see page 692)	<value> ::= Expected current value in NR3 format [suffix] ::= {A mA}
:POWer:SIGNals:OVERsh oot <percent> (see page 693)	:POWer:SIGNals:OVERsh oot? (see page 693)	<percent> ::= percent of overshoot value in NR1 format [suffix] ::= {V mV}
:POWer:SIGNals:VMAXim um:INRush <value>[suffix] (see page 694)	:POWer:SIGNals:VMAXim um:INRush? (see page 694)	<value> ::= Maximum expected input Voltage in NR3 format [suffix] ::= {V mV}
:POWer:SIGNals:VMAXim um:ONOff:OFF <value>[suffix] (see page 695)	:POWer:SIGNals:VMAXim um:ONOff:OFF? (see page 695)	<value> ::= Maximum expected input Voltage in NR3 format [suffix] ::= {V mV}
:POWer:SIGNals:VMAXim um:ONOff:ON <value>[suffix] (see page 696)	:POWer:SIGNals:VMAXim um:ONOff:ON? (see page 696)	<value> ::= Maximum expected input Voltage in NR3 format [suffix] ::= {V mV}
:POWer:SIGNals:VSTead y:ONOff:OFF <value>[suffix] (see page 697)	:POWer:SIGNals:VSTead y:ONOff:OFF? (see page 697)	<value> ::= Expected steady stage output Voltage value in NR3 format [suffix] ::= {V mV}
:POWer:SIGNals:VSTead y:ONOff:ON <value>[suffix] (see page 698)	:POWer:SIGNals:VSTead y:ONOff:ON? (see page 698)	<value> ::= Expected steady stage output Voltage value in NR3 format [suffix] ::= {V mV}
:POWer:SIGNals:VSTead y:TRANSient <value>[suffix] (see page 699)	:POWer:SIGNals:VSTead y:TRANSient? (see page 699)	<value> ::= Expected steady stage output Voltage value in NR3 format [suffix] ::= {V mV}
:POWer:SIGNals:SOURce :CURRent<i> <source> (see page 700)	:POWer:SIGNals:SOURce :CURRent<i>? (see page 700)	<i> ::= 1, 2 in NR1 format <source> ::= CHANnel<n> <n> ::= 1 to (# analog channels) in NR1 format

Table 23 :POWer Commands Summary (continued)

Command	Query	Options and Query Returns
:POWer:SIGNals:SOURce :VOLTage<i> <source> (see page 701)	:POWer:SIGNals:SOURce :VOLTage<i>? (see page 701)	<i> ::= 1, 2 in NR1 format <source> ::= CHANnel<n> <n> ::= 1 to (# analog channels) in NR1 format
:POWer:SLEW:APPLy (see page 702)	n/a	n/a
:POWer:SLEW:SOURce <source> (see page 703)	:POWer:SLEW:SOURce? (see page 703)	<source> ::= {V I}
:POWer:SWITCh:APPLy (see page 704)	n/a	n/a
:POWer:SWITCh:CONduct ion <conduction> (see page 705)	:POWer:SWITCh:CONduct ion? (see page 705)	<conduction> ::= {WAVEform RDS VCE}
:POWer:SWITCh:IREFere nce <percent> (see page 706)	:POWer:SWITCh:IREFere nce? (see page 706)	<percent> ::= percent in NR1 format
:POWer:SWITCh:RDS <value>[suffix] (see page 707)	:POWer:SWITCh:RDS? (see page 707)	<value> ::= Rds(on) value in NR3 format [suffix] ::= {OHM mOHM}
:POWer:SWITCh:VCE <value>[suffix] (see page 708)	:POWer:SWITCh:VCE? (see page 708)	<value> ::= Vce(sat) value in NR3 format [suffix] ::= {V mV}
:POWer:SWITCh:VREFere nce <percent> (see page 709)	:POWer:SWITCh:VREFere nce? (see page 709)	<percent> ::= percent in NR1 format
:POWer:TRANSient:APPL y (see page 710)	n/a	n/a
:POWer:TRANSient:EXIT (see page 711)	n/a	n/a
:POWer:TRANSient:IINI tial <value>[suffix] (see page 712)	:POWer:TRANSient:IINI tial? (see page 712)	<value> ::= Initial current value in NR3 format [suffix] ::= {A mA}
:POWer:TRANSient:INEW <value>[suffix] (see page 713)	:POWer:TRANSient:INEW ? (see page 713)	<value> ::= New current value in NR3 format [suffix] ::= {A mA}
:POWer:TRANSient:NEXT (see page 714)	n/a	n/a

Table 24 :RECall Commands Summary

Command	Query	Options and Query Returns
:RECall:ARBitrary:[STArT] [<file_spec>] [, <column>] [, <wavegen_id>] (see page 717)	n/a	<file_spec> ::= {<internal_loc> <file_name>} <column> ::= Column in CSV file to load. Column number starts from 1. <internal_loc> ::= 0-3; an integer in NR1 format <file_name> ::= quoted ASCII string <wavegen_id> ::= WGEN1
:RECall:DBc[:STArT] [<file_name>] [, <serialbus>] (see page 718)	n/a	<file_name> ::= quoted ASCII string If extension included in file name, it must be ".dbc". <serialbus> ::= {SBUS<n>} <n> ::= 1 to (# of serial bus) in NR1 format
:RECall:FIleName <base_name> (see page 719)	:RECall:FIleName? (see page 719)	<base_name> ::= quoted ASCII string
:RECall:LDF[:STArT] [<file_name>] [, <serialbus>] (see page 720)	n/a	<file_name> ::= quoted ASCII string If extension included in file name, it must be ".ldf". <serialbus> ::= {SBUS<n>} <n> ::= 1 to (# of serial bus) in NR1 format
:RECall:MASk[:STArT] [<file_spec>] (see page 721)	n/a	<file_spec> ::= {<internal_loc> <file_name>} <internal_loc> ::= 0-3; an integer in NR1 format <file_name> ::= quoted ASCII string
:RECall:PWD <path_name> (see page 722)	:RECall:PWD? (see page 722)	<path_name> ::= quoted ASCII string

Table 24 :RECall Commands Summary (continued)

Command	Query	Options and Query Returns
:RECall:SETup[:START] [<file_spec>] (see page 723)	n/a	<file_spec> ::= {<internal_loc> <file_name>} <internal_loc> ::= 0-9; an integer in NR1 format <file_name> ::= quoted ASCII string
:RECall:WMEMemory<r>[:START] [<file_name>] (see page 724)	n/a	<r> ::= 1 to (# ref waveforms) in NR1 format <file_name> ::= quoted ASCII string If extension included in file name, it must be ".h5".

Table 25 :SAVE Commands Summary

Command	Query	Options and Query Returns
:SAVE:ARbitrary[:START] [<file_spec>] [, <wavegen_id>] (see page 729)	n/a	<file_spec> ::= {<internal_loc> <file_name>} <internal_loc> ::= 0-3; an integer in NR1 format <file_name> ::= quoted ASCII string <wavegen_id> ::= WGEN1
:SAVE:FILEname <base_name> (see page 730)	:SAVE:FILEname? (see page 730)	<base_name> ::= quoted ASCII string
:SAVE:IMAGe[:START] [<file_name>] (see page 731)	n/a	<file_name> ::= quoted ASCII string
:SAVE:IMAGe:FACTors {{0 OFF} {1 ON}} (see page 732)	:SAVE:IMAGe:FACTors? (see page 732)	{0 1}
:SAVE:IMAGe:FORMat <format> (see page 733)	:SAVE:IMAGe:FORMat? (see page 733)	<format> ::= {{BMP BMP24bit} BMP8bit PNG NONE}
:SAVE:IMAGe:INKSaver {{0 OFF} {1 ON}} (see page 734)	:SAVE:IMAGe:INKSaver? (see page 734)	{0 1}
:SAVE:IMAGe:PALette <palette> (see page 735)	:SAVE:IMAGe:PALette? (see page 735)	<palette> ::= {COLor GRAYscale}

Table 25 :SAVE Commands Summary (continued)

Command	Query	Options and Query Returns
:SAVE:LISTer[:START] [<file_name>] (see page 736)	n/a	<file_name> ::= quoted ASCII string
:SAVE:MASK[:START] [<file_spec>] (see page 737)	n/a	<file_spec> ::= {<internal_loc> <file_name>} <internal_loc> ::= 0-3; an integer in NR1 format <file_name> ::= quoted ASCII string
:SAVE:MULTi[:START] [<file_name>] (see page 738)	n/a	<file_name> ::= quoted ASCII string
:SAVE:POWer[:START] [<file_name>] (see page 739)	n/a	<file_name> ::= quoted ASCII string
:SAVE:PWD <path_name> (see page 740)	:SAVE:PWD? (see page 740)	<path_name> ::= quoted ASCII string
:SAVE:RESults:[START] [<file_spec>] (see page 741)	n/a	<file_name> ::= quoted ASCII string
:SAVE:RESults:FORMat: CURSor {{0 OFF} {1 ON}} (see page 742)	:SAVE:RESults:FORMat: CURSor? (see page 742)	{0 1}
:SAVE:RESults:FORMat: MASK {{0 OFF} {1 ON}} (see page 743)	:SAVE:RESults:FORMat: MASK? (see page 743)	{0 1}
:SAVE:RESults:FORMat: MEASurement {{0 OFF} {1 ON}} (see page 744)	:SAVE:RESults:FORMat: MEASurement? (see page 744)	{0 1}
:SAVE:RESults:FORMat: SEARch {{0 OFF} {1 ON}} (see page 745)	:SAVE:RESults:FORMat: SEARch? (see page 745)	{0 1}
:SAVE:RESults:FORMat: SEGmented {{0 OFF} {1 ON}} (see page 746)	:SAVE:RESults:FORMat: SEGmented? (see page 746)	{0 1}

Table 25 :SAVE Commands Summary (continued)

Command	Query	Options and Query Returns
:SAVE:SETup[:START] [<file_spec>] (see page 747)	n/a	<file_spec> ::= {<internal_loc> <file_name>} <internal_loc> ::= 0-9; an integer in NR1 format <file_name> ::= quoted ASCII string
:SAVE:WAVEform[:START] [<file_name>] (see page 748)	n/a	<file_name> ::= quoted ASCII string
:SAVE:WAVEform:FORMat <format> (see page 749)	:SAVE:WAVEform:FORMat? (see page 749)	<format> ::= {ASCIixy CSV BINary NONE}
:SAVE:WAVEform:LENGth <length> (see page 750)	:SAVE:WAVEform:LENGth? (see page 750)	<length> ::= 100 to max. length; an integer in NR1 format
:SAVE:WAVEform:LENGth:MAX {{0 OFF} {1 ON}} (see page 751)	:SAVE:WAVEform:LENGth:MAX? (see page 751)	{0 1}
:SAVE:WAVEform:SEGMent <option> (see page 752)	:SAVE:WAVEform:SEGMent? (see page 752)	<option> ::= {ALL CURRent}
:SAVE:WMEMory:SOURce <source> (see page 753)	:SAVE:WMEMory:SOURce? (see page 753)	<source> ::= {CHANnel<n> FUNction<m> MATH<m> WMEMory<r>} <n> ::= 1 to (# analog channels) in NR1 format <m> ::= 1 to (# math functions) in NR1 format <r> ::= 1 to (# ref waveforms) in NR1 format NOTE: Only ADD or SUBtract math operations can be saved as reference waveforms. <return_value> ::= <source>
:SAVE:WMEMory[:START] [<file_name>] (see page 754)	n/a	<file_name> ::= quoted ASCII string If extension included in file name, it must be ".h5".

Table 26 General :SBUS<n> Commands Summary

Command	Query	Options and Query Returns
:SBUS<n>:DISPlay {{0 OFF}} {{1 ON}} (see page 758)	:SBUS<n>:DISPlay? (see page 758)	{0 1}
:SBUS<n>:MODE <mode> (see page 759)	:SBUS<n>:MODE? (see page 759)	<mode> ::= {A429 CAN CXPI FLEXray I2S IIC LIN M1553 SENT SPI UART}

Table 27 :SBUS<n>:A429 Commands Summary

Command	Query	Options and Query Returns
:SBUS<n>:A429:AUToset up (see page 762)	n/a	n/a
:SBUS<n>:A429:BASE <base> (see page 763)	:SBUS<n>:A429:BASE? (see page 763)	<base> ::= {BINary HEX}
n/a	:SBUS<n>:A429:COUNT:ERRor? (see page 764)	<error_count> ::= integer in NR1 format
:SBUS<n>:A429:COUNT:RESet (see page 765)	n/a	n/a
n/a	:SBUS<n>:A429:COUNT:WORD? (see page 766)	<word_count> ::= integer in NR1 format
:SBUS<n>:A429:FORMat <format> (see page 767)	:SBUS<n>:A429:FORMat? (see page 767)	<format> ::= {LDSDi LDSSm LDATa}
:SBUS<n>:A429:SIGNal <signal> (see page 768)	:SBUS<n>:A429:SIGNal? (see page 768)	<signal> ::= {A B DIFFerential}
:SBUS<n>:A429:SOURce <source> (see page 769)	:SBUS<n>:A429:SOURce? (see page 769)	<source> ::= {CHANnel<n>} <n> ::= 1 to (# analog channels) in NR1 format
:SBUS<n>:A429:SPEed <speed> (see page 770)	:SBUS<n>:A429:SPEed? (see page 770)	<speed> ::= {LOW HIGH}

Table 27 :SBUS<n>:A429 Commands Summary (continued)

Command	Query	Options and Query Returns
:SBUS<n>:A429:TRIGger :LABel <value> (see page 771)	:SBUS<n>:A429:TRIGger :LABel? (see page 771)	<value> ::= 8-bit integer in decimal, <hex>, <octal>, or <string> from 0-255 or "0xXX" (don't care) <hex> ::= #Hnn where n ::= {0,...,9 A,...,F} <octal> ::= #Qnnn where n ::= {0,...,7} <string> ::= "0xnn" where n ::= {0,...,9 A,...,F}
:SBUS<n>:A429:TRIGger :PATtern:DATA <string> (see page 772)	:SBUS<n>:A429:TRIGger :PATtern:DATA? (see page 772)	<string> ::= "nn...n" where n ::= {0 1 X}, length depends on FORMat
:SBUS<n>:A429:TRIGger :PATtern:SDI <string> (see page 773)	:SBUS<n>:A429:TRIGger :PATtern:SDI? (see page 773)	<string> ::= "nn" where n ::= {0 1 X}, length always 2 bits
:SBUS<n>:A429:TRIGger :PATtern:SSM <string> (see page 774)	:SBUS<n>:A429:TRIGger :PATtern:SSM? (see page 774)	<string> ::= "nn" where n ::= {0 1 X}, length always 2 bits
:SBUS<n>:A429:TRIGger :RANGe <min>, <max> (see page 775)	:SBUS<n>:A429:TRIGger :RANGe? (see page 775)	<min> ::= 8-bit integer in decimal, <hex>, <octal>, or <string> from 0-255 <max> ::= 8-bit integer in decimal, <hex>, <octal>, or <string> from 0-255 <hex> ::= #Hnn where n ::= {0,...,9 A,...,F} <octal> ::= #Qnnn where n ::= {0,...,7} <string> ::= "0xnn" where n ::= {0,...,9 A,...,F}
:SBUS<n>:A429:TRIGger :TYPE <condition> (see page 776)	:SBUS<n>:A429:TRIGger :TYPE? (see page 776)	<condition> ::= {WStArt WStOp LABel LBITs PERror WERror GERror WGERrors ALLerrors LRANGe ABITs AOBits AZBits}

Table 28 :SBUS<n>:CAN Commands Summary

Command	Query	Options and Query Returns
n/a	:SBUS<n>:CAN:COUNT:ER Ror? (see page 780)	<frame_count> ::= integer in NR1 format
n/a	:SBUS<n>:CAN:COUNT:OV ERload? (see page 781)	<frame_count> ::= 0 in NR1 format
:SBUS<n>:CAN:COUNT:RE Set (see page 782)	n/a	n/a
n/a	:SBUS<n>:CAN:COUNT:SP EC? (see page 783)	<spec_error_count> ::= integer in NR1 format
n/a	:SBUS<n>:CAN:COUNT:TO Tal? (see page 784)	<frame_count> ::= integer in NR1 format
n/a	:SBUS<n>:CAN:COUNT:UT ILization? (see page 785)	<percent> ::= floating-point in NR3 format
:SBUS<n>:CAN:DISPlay <type> (see page 786)	:SBUS<n>:CAN:DISPlay? (see page 786)	<type> ::= {HEXadecimal SYMBOLic}
:SBUS<n>:CAN:FDSPoint <value> (see page 787)	:SBUS<n>:CAN:FDSPoint ? (see page 787)	<value> ::= even numbered percentages from 30 to 90 in NR3 format.
:SBUS<n>:CAN:FDSTanda rd <std> (see page 788)	:SBUS<n>:CAN:FDSTanda rd? (see page 788)	<std> ::= {ISO NISO}
:SBUS<n>:CAN:SAMplepo int <percent> (see page 789)	:SBUS<n>:CAN:SAMplepo int? (see page 789)	<percent> ::= 30.0 to 90.0 in NR3 format
:SBUS<n>:CAN:SIGNAL:BA UDrate <baudrate> (see page 790)	:SBUS<n>:CAN:SIGNAL:BA UDrate? (see page 790)	<baudrate> ::= integer from 10000 to 4000000 in 100 b/s increments, or 5000000
:SBUS<n>:CAN:SIGNAL:DE Finition <value> (see page 791)	:SBUS<n>:CAN:SIGNAL:DE Finition? (see page 791)	<value> ::= {CANH CANL RX TX DIFFerential DIFL DIFH}
:SBUS<n>:CAN:SIGNAL:FB AUDrate <baudrate> (see page 792)	:SBUS<n>:CAN:SIGNAL:FB AUDrate? (see page 792)	<baudrate> ::= integer from 10000 to 10000000 in 100 b/s increments.

Table 28 :SBUS<n>:CAN Commands Summary (continued)

Command	Query	Options and Query Returns
:SBUS<n>:CAN:SOURce <source> (see page 793)	:SBUS<n>:CAN:SOURce? (see page 793)	<source> ::= {CHANnel<n> EXTernal} for DSO models <source> ::= {CHANnel<n> DIGital<d> } for MSO models <n> ::= 1 to (# analog channels) in NR1 format <d> ::= 0 to (# digital channels - 1) in NR1 format
:SBUS<n>:CAN:TRIGger <condition> (see page 794)	:SBUS<n>:CAN:TRIGger? (see page 795)	<condition> ::= {SOF EOF IDData DATA FDData IDRemote IDEither ERRor ACKerror FORMerror STUFFerror CRCerror SPECerror ALLerrors BRsBit CRCDbit EBActive EBPAssive OVERload MESSage MSIGnal FDMSignal}
:SBUS<n>:CAN:TRIGger:IDFilter {{0 OFF} {1 ON}} (see page 797)	:SBUS<n>:CAN:TRIGger:IDFilter? (see page 797)	{0 1}
:SBUS<n>:CAN:TRIGger:PATtern:DATA <string> (see page 798)	:SBUS<n>:CAN:TRIGger:PATtern:DATA? (see page 798)	<string> ::= "nn...n" where n ::= {0 1 X \$} <string ::= "0xnn...n" where n ::= {0,...,9 A,...,F X \$}
:SBUS<n>:CAN:TRIGger:PATtern:DATA:DLC <dlc> (see page 799)	:SBUS<n>:CAN:TRIGger:PATtern:DATA:DLC? (see page 799)	<dlc> ::= integer between -1 (don't care) and 64, in NR1 format.
:SBUS<n>:CAN:TRIGger:PATtern:DATA:LENGth <length> (see page 800)	:SBUS<n>:CAN:TRIGger:PATtern:DATA:LENGth? (see page 800)	<length> ::= integer from 1 to 8 in NR1 format
:SBUS<n>:CAN:TRIGger:PATtern:DATA:STARt <start> (see page 801)	:SBUS<n>:CAN:TRIGger:PATtern:DATA:STARt? (see page 801)	<start> ::= integer between 0 and 63, in NR1 format.
:SBUS<n>:CAN:TRIGger:PATtern:ID <string> (see page 802)	:SBUS<n>:CAN:TRIGger:PATtern:ID? (see page 802)	<string> ::= "nn...n" where n ::= {0 1 X \$} <string ::= "0xnn...n" where n ::= {0,...,9 A,...,F X \$}
:SBUS<n>:CAN:TRIGger:PATtern:ID:MODE <value> (see page 803)	:SBUS<n>:CAN:TRIGger:PATtern:ID:MODE? (see page 803)	<value> ::= {STANdard EXTended}

Table 28 :SBUS<n>:CAN Commands Summary (continued)

Command	Query	Options and Query Returns
:SBUS<n>:CAN:TRIGger:SYMBOLic:MESSAge <name> (see page 804)	:SBUS<n>:CAN:TRIGger:SYMBOLic:MESSAge? (see page 804)	<name> ::= quoted ASCII string
:SBUS<n>:CAN:TRIGger:SYMBOLic:SIGNAL <name> (see page 805)	:SBUS<n>:CAN:TRIGger:SYMBOLic:SIGNAL? (see page 805)	<name> ::= quoted ASCII string
:SBUS<n>:CAN:TRIGger:SYMBOLic:VALue <data> (see page 806)	:SBUS<n>:CAN:TRIGger:SYMBOLic:VALue? (see page 806)	<data> ::= value in NR3 format

Table 29 :SBUS<n>:CXPI Commands Summary

Command	Query	Options and Query Returns
:SBUS<n>:CXPI:BAUDrate <baudrate> (see page 809)	:SBUS<n>:CXPI:BAUDrate? (see page 809)	<baudrate> ::= integer from 9600 to 40000 in 100 b/s increments.
:SBUS<n>:CXPI:PARity {{0 OFF} {1 ON}} (see page 810)	:SBUS<n>:CXPI:PARity? (see page 810)	{0 1}
:SBUS<n>:CXPI:SOURce <source> (see page 811)	:SBUS<n>:CXPI:SOURce? (see page 811)	<source> ::= {CHANnel<n>} <n> ::= 1 to (# analog channels) in NR1 format
:SBUS<n>:CXPI:TOLerance <percent> (see page 812)	:SBUS<n>:CXPI:TOLerance? (see page 812)	<percent> ::= from 1-30, in NR1 format.
:SBUS<n>:CXPI:TRIGger <mode> (see page 813)	:SBUS<n>:CXPI:TRIGger? (see page 814)	<mode> ::= {SOF EOF PTYPE ID DATA LDATa CRCError PARityerror IBSerror IFSerror FRAMingerror DLENgtherror SAMPlerror ALLerrors SLEepframe WAKEuppulse}
:SBUS<n>:CXPI:TRIGger:IDFilter {{0 OFF} {1 ON}} (see page 815)	:SBUS<n>:CXPI:TRIGger:IDFilter? (see page 815)	{0 1}
:SBUS<n>:CXPI:TRIGger:PTYPE {{0 OFF} {1 ON}} (see page 816)	:SBUS<n>:CXPI:TRIGger:PTYPE? (see page 816)	{0 1}

Table 29 :SBUS<n>:CXPI Commands Summary (continued)

Command	Query	Options and Query Returns
:SBUS<n>:CXPI:TRIGger :PATtern:DATA <string> (see page 817)	:SBUS<n>:CXPI:TRIGger :PATtern:DATA? (see page 817)	<string> ::= "nn...n" where n ::= {0 1 X} <string ::= "0xnn...n" where n ::= {0,...,9 A,...,F X}
:SBUS<n>:CXPI:TRIGger :PATtern:DATA:LENGth <length> (see page 818)	:SBUS<n>:CXPI:TRIGger :PATtern:DATA:LENGth? (see page 818)	<start> ::= integer between 0 and 12, in NR1 format.
:SBUS<n>:CXPI:TRIGger :PATtern:DATA:STARt <start> (see page 819)	:SBUS<n>:CXPI:TRIGger :PATtern:DATA:STARt? (see page 819)	<start> ::= integer between 0 and 255, in NR1 format.
:SBUS<n>:CXPI:TRIGger :PATtern:ID <string> (see page 820)	:SBUS<n>:CXPI:TRIGger :PATtern:ID? (see page 820)	<string> ::= "nn...n" where n ::= {0 1 X} <string ::= "0xnn...n" where n ::= {0,...,9 A,...,F X}
:SBUS<n>:CXPI:TRIGger :PATtern:INFO:CT <string> (see page 821)	:SBUS<n>:CXPI:TRIGger :PATtern:INFO:CT? (see page 821)	<string> ::= "nn" where n ::= {0 1 X}
:SBUS<n>:CXPI:TRIGger :PATtern:INFO:DLC <dlc> (see page 822)	:SBUS<n>:CXPI:TRIGger :PATtern:INFO:DLC? (see page 822)	<dlc> ::= integer between -1 (don't care) and 15, in NR1 format, when trigger is in DATA mode. <dlc> ::= integer between -1 (don't care) and 255, in NR1 format, when trigger is in LDAta mode.
:SBUS<n>:CXPI:TRIGger :PATtern:INFO:NM <string> (see page 823)	:SBUS<n>:CXPI:TRIGger :PATtern:INFO:NM? (see page 823)	<string> ::= "nn" where n ::= {0 1 X}

Table 30 :SBUS<n>:FLEXray Commands Summary

Command	Query	Options and Query Returns
:SBUS<n>:FLEXray:AUTO setup (see page 826)	n/a	n/a
:SBUS<n>:FLEXray:BAUD rate <baudrate> (see page 827)	:SBUS<n>:FLEXray:BAUD rate? (see page 827)	<baudrate> ::= {2500000 5000000 10000000}

Table 30 :SBUS<n>:FLEXray Commands Summary (continued)

Command	Query	Options and Query Returns
:SBUS<n>:FLEXray:CHANnel <channel> (see page 828)	:SBUS<n>:FLEXray:CHANnel? (see page 828)	<channel> ::= {A B}
n/a	:SBUS<n>:FLEXray:COUNt:NULL? (see page 829)	<frame_count> ::= integer in NR1 format
:SBUS<n>:FLEXray:COUNt:RESet (see page 830)	n/a	n/a
n/a	:SBUS<n>:FLEXray:COUNt:SYNC? (see page 831)	<frame_count> ::= integer in NR1 format
n/a	:SBUS<n>:FLEXray:COUNt:TOTal? (see page 832)	<frame_count> ::= integer in NR1 format
:SBUS<n>:FLEXray:SOURce <source> (see page 833)	:SBUS<n>:FLEXray:SOURce? (see page 833)	<source> ::= {CHANnel<n>} <n> ::= 1-2 or 1-4 in NR1 format
:SBUS<n>:FLEXray:TRIGger <condition> (see page 834)	:SBUS<n>:FLEXray:TRIGger? (see page 834)	<condition> ::= {FRAME ERRor EVENT}
:SBUS<n>:FLEXray:TRIGger:ERRor:TYPE <error_type> (see page 835)	:SBUS<n>:FLEXray:TRIGger:ERRor:TYPE? (see page 835)	<error_type> ::= {ALL HCRC FCRC}
:SBUS<n>:FLEXray:TRIGger:EVENT:AUToset (see page 836)	n/a	n/a
:SBUS<n>:FLEXray:TRIGger:EVENT:BSS:ID <frame_id> (see page 837)	:SBUS<n>:FLEXray:TRIGger:EVENT:BSS:ID? (see page 837)	<frame_id> ::= {ALL <frame #>} <frame #> ::= integer from 1-2047
:SBUS<n>:FLEXray:TRIGger:EVENT:TYPE <event> (see page 838)	:SBUS<n>:FLEXray:TRIGger:EVENT:TYPE? (see page 838)	<event> ::= {WAKEup TSS {FES DTS} BSS}
:SBUS<n>:FLEXray:TRIGger:FRAME:CCBase <cycle_count_base> (see page 839)	:SBUS<n>:FLEXray:TRIGger:FRAME:CCBase? (see page 839)	<cycle_count_base> ::= integer from 0-63
:SBUS<n>:FLEXray:TRIGger:FRAME:CCRepetitio n <cycle_count_repetitio n> (see page 840)	:SBUS<n>:FLEXray:TRIGger:FRAME:CCRepetitio n? (see page 840)	<cycle_count_repetition> ::= {ALL <rep #>} <rep #> ::= integer values 2, 4, 8, 16, 32, or 64

Table 30 :SBUS<n>:FLEXray Commands Summary (continued)

Command	Query	Options and Query Returns
:SBUS<n>:FLEXray:TRIGGER:FRAME:ID <frame_id> (see page 841)	:SBUS<n>:FLEXray:TRIGGER:FRAME:ID? (see page 841)	<frame_id> ::= {ALL <frame #>} <frame #> ::= integer from 1-2047
:SBUS<n>:FLEXray:TRIGGER:FRAME:TYPE <frame_type> (see page 842)	:SBUS<n>:FLEXray:TRIGGER:FRAME:TYPE? (see page 842)	<frame_type> ::= {NORMAL STARTup NULL SYNC NSTARTup NNULl NSYNc ALL}

Table 31 :SBUS<n>:I2S Commands Summary

Command	Query	Options and Query Returns
:SBUS<n>:I2S:ALIGNment <setting> (see page 845)	:SBUS<n>:I2S:ALIGNment? (see page 845)	<setting> ::= {I2S LJ RJ}
:SBUS<n>:I2S:BASE <base> (see page 846)	:SBUS<n>:I2S:BASE? (see page 846)	<base> ::= {DECimal HEX}
:SBUS<n>:I2S:CLOCK:SLOPe <slope> (see page 847)	:SBUS<n>:I2S:CLOCK:SLOPe? (see page 847)	<slope> ::= {NEGative POSitive}
:SBUS<n>:I2S:RWIDTH <receiver> (see page 848)	:SBUS<n>:I2S:RWIDTH? (see page 848)	<receiver> ::= 4-32 in NR1 format
:SBUS<n>:I2S:SOURCE:CLOCK <source> (see page 849)	:SBUS<n>:I2S:SOURCE:CLOCK? (see page 849)	<source> ::= {CHANnel<n> EXTERNAL} for DSO models <source> ::= {CHANnel<n> DIGital<d> } for MSO models <n> ::= 1 to (# analog channels) in NR1 format <d> ::= 0 to (# digital channels - 1) in NR1 format
:SBUS<n>:I2S:SOURCE:DATA <source> (see page 850)	:SBUS<n>:I2S:SOURCE:DATA? (see page 850)	<source> ::= {CHANnel<n> EXTERNAL} for DSO models <source> ::= {CHANnel<n> DIGital<d> } for MSO models <n> ::= 1 to (# analog channels) in NR1 format <d> ::= 0 to (# digital channels - 1) in NR1 format

Table 31 :SBUS<n>:I2S Commands Summary (continued)

Command	Query	Options and Query Returns
:SBUS<n>:I2S:SOURce:WSElect <source> (see page 851)	:SBUS<n>:I2S:SOURce:WSElect? (see page 851)	<source> ::= {CHANnel<n> EXTErnal} for DSO models <source> ::= {CHANnel<n> DIGital<d>} for MSO models <n> ::= 1 to (# analog channels) in NR1 format <d> ::= 0 to (# digital channels - 1) in NR1 format
:SBUS<n>:I2S:TRIGger <operator> (see page 852)	:SBUS<n>:I2S:TRIGger? (see page 852)	<operator> ::= {EQUal NOTequal LESSthan GREATERthan INRange OUTRange INCRasing DECRasing}
:SBUS<n>:I2S:TRIGger:AUDio <audio_ch> (see page 854)	:SBUS<n>:I2S:TRIGger:AUDio? (see page 854)	<audio_ch> ::= {RIGHT LEFT EITHer}
:SBUS<n>:I2S:TRIGger:PATtern:DATA <string> (see page 855)	:SBUS<n>:I2S:TRIGger:PATtern:DATA? (see page 856)	<string> ::= "n" where n ::= 32-bit integer in signed decimal when <base> = DECimal <string> ::= "nn...n" where n ::= {0 1 X \$} when <base> = BINary <string> ::= "0xnn...n" where n ::= {0,...,9 A,...,F X \$} when <base> = HEX
:SBUS<n>:I2S:TRIGger:PATtern:FORMat <base> (see page 857)	:SBUS<n>:I2S:TRIGger:PATtern:FORMat? (see page 857)	<base> ::= {BINary HEX DECimal}
:SBUS<n>:I2S:TRIGger:RANGe <lower>, <upper> (see page 858)	:SBUS<n>:I2S:TRIGger:RANGe? (see page 858)	<lower> ::= 32-bit integer in signed decimal, <nondecimal>, or <string> <upper> ::= 32-bit integer in signed decimal, <nondecimal>, or <string> <nondecimal> ::= #Hnn...n where n ::= {0,...,9 A,...,F} for hexadecimal <nondecimal> ::= #Bnn...n where n ::= {0 1} for binary <string> ::= "0xnn...n" where n ::= {0,...,9 A,...,F} for hexadecimal

Table 31 :SBUS<n>:I2S Commands Summary (continued)

Command	Query	Options and Query Returns
:SBUS<n>:I2S:TWIDth <word_size> (see page 860)	:SBUS<n>:I2S:TWIDth? (see page 860)	<word_size> ::= 4-32 in NR1 format
:SBUS<n>:I2S:WSLow <low_def> (see page 861)	:SBUS<n>:I2S:WSLow? (see page 861)	<low_def> ::= {LEFT RIGHT}

Table 32 :SBUS<n>:IIC Commands Summary

Command	Query	Options and Query Returns
:SBUS<n>:IIC:ASIZE <size> (see page 863)	:SBUS<n>:IIC:ASIZE? (see page 863)	<size> ::= {BIT7 BIT8}
:SBUS<n>:IIC[:SOURce] :CLOCK <source> (see page 864)	:SBUS<n>:IIC[:SOURce] :CLOCK? (see page 864)	<source> ::= {CHANnel<n> EXTernal} for DSO models <source> ::= {CHANnel<n> DIGital<d> } for MSO models <n> ::= 1 to (# analog channels) in NR1 format <d> ::= 0 to (# digital channels - 1) in NR1 format
:SBUS<n>:IIC[:SOURce] :DATA <source> (see page 865)	:SBUS<n>:IIC[:SOURce] :DATA? (see page 865)	<source> ::= {CHANnel<n> EXTernal} for DSO models <source> ::= {CHANnel<n> DIGital<d> } for MSO models <n> ::= 1 to (# analog channels) in NR1 format <d> ::= 0 to (# digital channels - 1) in NR1 format
:SBUS<n>:IIC:TRIGger: PATTern:ADDRESS <value> (see page 866)	:SBUS<n>:IIC:TRIGger: PATTern:ADDRESS? (see page 866)	<value> ::= integer or <string> <string> ::= "0xnn" n ::= {0,...,9 A,...,F}
:SBUS<n>:IIC:TRIGger: PATTern:DATA <value> (see page 867)	:SBUS<n>:IIC:TRIGger: PATTern:DATA? (see page 867)	<value> ::= integer or <string> <string> ::= "0xnn" n ::= {0,...,9 A,...,F}
:SBUS<n>:IIC:TRIGger: PATTern:DATA2 <value> (see page 868)	:SBUS<n>:IIC:TRIGger: PATTern:DATA2? (see page 868)	<value> ::= integer or <string> <string> ::= "0xnn" n ::= {0,...,9 A,...,F}

Table 32 :SBUS<n>:IIC Commands Summary (continued)

Command	Query	Options and Query Returns
:SBUS<n>:IIC:TRIGger:QUALifier <value> (see page 869)	:SBUS<n>:IIC:TRIGger:QUALifier? (see page 869)	<value> ::= {EQUAL NOTequal LESSthan GREATERthan}
:SBUS<n>:IIC:TRIGger[:TYPE] <type> (see page 870)	:SBUS<n>:IIC:TRIGger[:TYPE]? (see page 870)	<type> ::= {START STOP READ7 READEprom WRITe7 WRITe10 NACKnowledge ANACK R7Data2 W7Data2 REStart}

Table 33 :SBUS<n>:LIN Commands Summary

Command	Query	Options and Query Returns
:SBUS<n>:LIN:DISPlay <type> (see page 874)	:SBUS<n>:LIN:DISPlay? (see page 874)	<type> ::= {HEXadecimal SYMBOLic}
:SBUS<n>:LIN:PARity {{0 OFF} {1 ON}} (see page 875)	:SBUS<n>:LIN:PARity? (see page 875)	{0 1}
:SBUS<n>:LIN:SAMplepoint <value> (see page 876)	:SBUS<n>:LIN:SAMplepoint? (see page 876)	<value> ::= {60 62.5 68 70 75 80 87.5} in NR3 format
:SBUS<n>:LIN:SIGNAL:BAUDrate <baudrate> (see page 877)	:SBUS<n>:LIN:SIGNAL:BAUDrate? (see page 877)	<baudrate> ::= integer from 2400 to 625000 in 100 b/s increments
:SBUS<n>:LIN:SOURce <source> (see page 878)	:SBUS<n>:LIN:SOURce? (see page 878)	<source> ::= {CHANnel<n> EXTernal} for DSO models <source> ::= {CHANnel<n> DIGital<d>} for MSO models <n> ::= 1 to (# analog channels) in NR1 format <d> ::= 0 to (# digital channels - 1) in NR1 format
:SBUS<n>:LIN:STANdard <std> (see page 879)	:SBUS<n>:LIN:STANdard? (see page 879)	<std> ::= {LIN13 LIN13NLC LIN20}
:SBUS<n>:LIN:SYNCbreak <value> (see page 880)	:SBUS<n>:LIN:SYNCbreak? (see page 880)	<value> ::= integer = {11 12 13}
:SBUS<n>:LIN:TRIGger <condition> (see page 881)	:SBUS<n>:LIN:TRIGger? (see page 881)	<condition> ::= {SYNCbreak ID DATA}

Table 33 :SBUS<n>:LIN Commands Summary (continued)

Command	Query	Options and Query Returns
:SBUS<n>:LIN:TRIGger:ID <value> (see page 882)	:SBUS<n>:LIN:TRIGger:ID? (see page 882)	<value> ::= 7-bit integer in decimal, <nondecimal>, or <string> from 0-63 or 0x00-0x3f <nondecimal> ::= #Hnn where n ::= {0,...,9 A,...,F} for hexadecimal <nondecimal> ::= #Bnn...n where n ::= {0 1} for binary <string> ::= "0xnn" where n ::= {0,...,9 A,...,F} for hexadecimal
:SBUS<n>:LIN:TRIGger:PATtern:DATA <string> (see page 883)	:SBUS<n>:LIN:TRIGger:PATtern:DATA? (see page 883)	<string> ::= "n" where n ::= 32-bit integer in unsigned decimal when <base> = DECimal <string> ::= "nn...n" where n ::= {0 1 X \$} when <base> = BINary <string> ::= "0xnn...n" where n ::= {0,...,9 A,...,F X \$} when <base> = HEX
:SBUS<n>:LIN:TRIGger:PATtern:DATA:LENGth <length> (see page 885)	:SBUS<n>:LIN:TRIGger:PATtern:DATA:LENGth? (see page 885)	<length> ::= integer from 1 to 8 in NR1 format
:SBUS<n>:LIN:TRIGger:PATtern:FORMat <base> (see page 886)	:SBUS<n>:LIN:TRIGger:PATtern:FORMat? (see page 886)	<base> ::= {BINary HEX DECimal}
:SBUS<n>:LIN:TRIGger:SYMBolic:FRAMe <name> (see page 887)	:SBUS<n>:LIN:TRIGger:SYMBolic:FRAMe? (see page 887)	<name> ::= quoted ASCII string
:SBUS<n>:LIN:TRIGger:SYMBolic:SIGNal <name> (see page 888)	:SBUS<n>:LIN:TRIGger:SYMBolic:SIGNal? (see page 888)	<name> ::= quoted ASCII string
:SBUS<n>:LIN:TRIGger:SYMBolic:VALue <data> (see page 889)	:SBUS<n>:LIN:TRIGger:SYMBolic:VALue? (see page 889)	<data> ::= value in NR3 format

Table 34 :SBUS<n>:M1553 Commands Summary

Command	Query	Options and Query Returns
:SBUS<n>:M1553:AUTOsetup (see page 891)	n/a	n/a
:SBUS<n>:M1553:BASE <base> (see page 892)	:SBUS<n>:M1553:BASE? (see page 892)	<base> ::= {BINary HEX}

Table 34 :SBUS<n>:M1553 Commands Summary (continued)

Command	Query	Options and Query Returns
:SBUS<n>:M1553:SOURce <source> (see page 893)	:SBUS<n>:M1553:SOURce? (see page 893)	<source> ::= {CHANnel<n>} <n> ::= 1 to (# analog channels) in NR1 format
:SBUS<n>:M1553:TRIGGer:PATtern:DATA <string> (see page 894)	:SBUS<n>:M1553:TRIGGer:PATtern:DATA? (see page 894)	<string> ::= "nn...n" where n ::= {0 1 X}
:SBUS<n>:M1553:TRIGGer:RTA <value> (see page 895)	:SBUS<n>:M1553:TRIGGer:RTA? (see page 895)	<value> ::= 5-bit integer in decimal, <nondecimal>, or <string> from 0-31 <nondecimal> ::= #Hnn where n ::= {0,...,9 A,...,F} <string> ::= "0xnn" where n ::= {0,...,9 A,...,F}
:SBUS<n>:M1553:TRIGGer:TYPE <type> (see page 896)	:SBUS<n>:M1553:TRIGGer:TYPE? (see page 896)	<type> ::= {DStArt DStOp CStArt CStOp RTA PERRor SERRor MERRor RTA11}

Table 35 :SBUS<n>:SENT Commands Summary

Command	Query	Options and Query Returns
:SBUS<n>:SENT:CLOCK <period> (see page 900)	:SBUS<n>:SENT:CLOCK? (see page 900)	<period> ::= the nominal clock period (tick), from 1 us to 300 us, in NR3 format.
:SBUS<n>:SENT:CRC <format> (see page 901)	:SBUS<n>:SENT:CRC? (see page 901)	<format> ::= {LEGacy RECommended}
:SBUS<n>:SENT:DISPlay <base> (see page 902)	:SBUS<n>:SENT:DISPlay? (see page 902)	<base> ::= {HEX DECimal SYMBolic}
:SBUS<n>:SENT:FORMat <decode> (see page 904)	:SBUS<n>:SENT:FORMat? (see page 904)	<decode> ::= {NIBBles FSIGnal FSSerial FESerial SSERial ESERial}
:SBUS<n>:SENT:IDLE <state> (see page 906)	:SBUS<n>:SENT:IDLE? (see page 906)	<state> ::= {LOW HIGH}
:SBUS<n>:SENT:LENGth <#_nibbles> (see page 907)	:SBUS<n>:SENT:LENGth? (see page 907)	<#_nibbles> ::= from 1-6, in NR1 format.
:SBUS<n>:SENT:PPULse { {0 OFF} {1 ON} } (see page 908)	:SBUS<n>:SENT:PPULse? (see page 908)	{0 1}

Table 35 :SBUS<n>:SENT Commands Summary (continued)

Command	Query	Options and Query Returns
:SBUS<n>:SENT:SIGnAl<s>:DISPlay {{0 OFF} {1 ON}} (see page 909)	:SBUS<n>:SENT:SIGnAl<s>:DISPlay? (see page 909)	<s> ::= 1-6, in NR1 format. {0 1}
:SBUS<n>:SENT:SIGnAl<s>:LENGth <length> (see page 910)	:SBUS<n>:SENT:SIGnAl<s>:LENGth? (see page 910)	<s> ::= 1-6, in NR1 format. <length> ::= from 1-24, in NR1 format.
:SBUS<n>:SENT:SIGnAl<s>:MULtiplier <multiplier> (see page 912)	:SBUS<n>:SENT:SIGnAl<s>:MULtiplier? (see page 912)	<s> ::= 1-6, in NR1 format. <multiplier> ::= from 1-24, in NR3 format.
:SBUS<n>:SENT:SIGnAl<s>:OFFSet <offset> (see page 913)	:SBUS<n>:SENT:SIGnAl<s>:OFFSet? (see page 913)	<s> ::= 1-6, in NR1 format. <offset> ::= from 1-24, in NR3 format.
:SBUS<n>:SENT:SIGnAl<s>:ORder <order> (see page 914)	:SBUS<n>:SENT:SIGnAl<s>:ORder? (see page 914)	<s> ::= 1-6, in NR1 format. <order> ::= {MSNFirst LSNFirst}
:SBUS<n>:SENT:SIGnAl<s>:STARt <position> (see page 916)	:SBUS<n>:SENT:SIGnAl<s>:STARt? (see page 916)	<s> ::= 1-6, in NR1 format. <position> ::= from 0-23, in NR1 format.
:SBUS<n>:SENT:SOURce <source> (see page 918)	:SBUS<n>:SENT:SOURce? (see page 918)	<source> ::= {CHANnel<n> DIGital<d>} <n> ::= 1 to (# analog channels) in NR1 format <d> ::= 0 to (# digital channels - 1) in NR1 format
:SBUS<n>:SENT:TOLerance <percent> (see page 920)	:SBUS<n>:SENT:TOLerance? (see page 920)	<percent> ::= from 3-30, in NR1 format.
:SBUS<n>:SENT:TRIGger <mode> (see page 921)	:SBUS<n>:SENT:TRIGger? (see page 921)	<mode> ::= {SFCMessage SSCMessage FCData SCMid SCData FCCerror SCCerror CRCerror TOLerror PPErrror SSPerror}
:SBUS<n>:SENT:TRIGger:FAST:DATA <string> (see page 923)	:SBUS<n>:SENT:TRIGger:FAST:DATA? (see page 923)	<string> ::= "nnnn..." where n ::= {0 1 X} <string> ::= "0xn..." where n ::= {0,...,9 A,...,F X \$}

Table 35 :SBUS<n>:SENT Commands Summary (continued)

Command	Query	Options and Query Returns
:SBUS<n>:SENT:TRIGger :SLOW:DATA <data> (see page 924)	:SBUS<n>:SENT:TRIGger :SLOW:DATA? (see page 924)	<data> ::= when ILENgth = SHORT, from -1 (don't care) to 65535, in NR1 format. <data> ::= when ILENgth = LONG, from -1 (don't care) to 4095, in NR1 format.
:SBUS<n>:SENT:TRIGger :SLOW:ID <id> (see page 926)	:SBUS<n>:SENT:TRIGger :SLOW:ID? (see page 926)	<id> ::= when ILENgth = SHORT, from -1 (don't care) to 15, in NR1 format. <id> ::= when ILENgth = LONG, from -1 (don't care) to 255, in NR1 format.
:SBUS<n>:SENT:TRIGger :SLOW:ILENgth <length> (see page 928)	:SBUS<n>:SENT:TRIGger :SLOW:ILENgth? (see page 928)	<length> ::= {SHORT LONG}
:SBUS<n>:SENT:TRIGger :TOLerance <percent> (see page 929)	:SBUS<n>:SENT:TRIGger :TOLerance? (see page 929)	<percent> ::= from 1-18, in NR1 format.

Table 36 :SBUS<n>:SPI Commands Summary

Command	Query	Options and Query Returns
:SBUS<n>:SPI:BITOrder <order> (see page 932)	:SBUS<n>:SPI:BITOrder ? (see page 932)	<order> ::= {LSBFirst MSBFirst}
:SBUS<n>:SPI:CLOCK:SL OPe <slope> (see page 933)	:SBUS<n>:SPI:CLOCK:SL OPe? (see page 933)	<slope> ::= {NEGative POSitive}
:SBUS<n>:SPI:CLOCK:TI Meout <time_value> (see page 934)	:SBUS<n>:SPI:CLOCK:TI Meout? (see page 934)	<time_value> ::= time in seconds in NR3 format
:SBUS<n>:SPI:FRAMing <value> (see page 935)	:SBUS<n>:SPI:FRAMing? (see page 935)	<value> ::= {CHIPselect {NCHipselect NOTC} TIMEout}
:SBUS<n>:SPI:SOURce:C LOCK <source> (see page 936)	:SBUS<n>:SPI:SOURce:C LOCK? (see page 936)	<value> ::= {CHANnel<n> EXTernal} for the DSO models <value> ::= {CHANnel<n> DIGital<d>} for the MSO models <n> ::= 1 to (# analog channels) in NR1 format <d> ::= 0 to (# digital channels - 1) in NR1 format

Table 36 :SBUS<n>:SPI Commands Summary (continued)

Command	Query	Options and Query Returns
:SBUS<n>:SPI:SOURce:FRAME <source> (see page 937)	:SBUS<n>:SPI:SOURce:FRAME? (see page 937)	<value> ::= {CHANnel<n> EXTErnal} for the DSO models <value> ::= {CHANnel<n> DIGital<d>} for the MSO models <n> ::= 1 to (# analog channels) in NR1 format <d> ::= 0 to (# digital channels - 1) in NR1 format
:SBUS<n>:SPI:SOURce:MISO <source> (see page 938)	:SBUS<n>:SPI:SOURce:MISO? (see page 938)	<value> ::= {CHANnel<n> EXTErnal} for the DSO models <value> ::= {CHANnel<n> DIGital<d>} for the MSO models <n> ::= 1 to (# analog channels) in NR1 format <d> ::= 0 to (# digital channels - 1) in NR1 format
:SBUS<n>:SPI:SOURce:MOSI <source> (see page 939)	:SBUS<n>:SPI:SOURce:MOSI? (see page 939)	<value> ::= {CHANnel<n> EXTErnal} for the DSO models <value> ::= {CHANnel<n> DIGital<d>} for the MSO models <n> ::= 1 to (# analog channels) in NR1 format <d> ::= 0 to (# digital channels - 1) in NR1 format
:SBUS<n>:SPI:TRIGger:PATtern:MISO:DATA <string> (see page 940)	:SBUS<n>:SPI:TRIGger:PATtern:MISO:DATA? (see page 940)	<string> ::= "nn...n" where n ::= {0 1 X \$} <string> ::= "0xnn...n" where n ::= {0,...,9 A,...,F X \$}
:SBUS<n>:SPI:TRIGger:PATtern:MISO:WIDTh <width> (see page 941)	:SBUS<n>:SPI:TRIGger:PATtern:MISO:WIDTh? (see page 941)	<width> ::= integer from 4 to 64 in NR1 format
:SBUS<n>:SPI:TRIGger:PATtern:MOSI:DATA <string> (see page 942)	:SBUS<n>:SPI:TRIGger:PATtern:MOSI:DATA? (see page 942)	<string> ::= "nn...n" where n ::= {0 1 X \$} <string> ::= "0xnn...n" where n ::= {0,...,9 A,...,F X \$}
:SBUS<n>:SPI:TRIGger:PATtern:MOSI:WIDTh <width> (see page 943)	:SBUS<n>:SPI:TRIGger:PATtern:MOSI:WIDTh? (see page 943)	<width> ::= integer from 4 to 64 in NR1 format

Table 36 :SBUS<n>:SPI Commands Summary (continued)

Command	Query	Options and Query Returns
:SBUS<n>:SPI:TRIGger:TYPE <value> (see page 944)	:SBUS<n>:SPI:TRIGger:TYPE? (see page 944)	<value> ::= {MOSI MISO}
:SBUS<n>:SPI:WIDTh <word_width> (see page 945)	:SBUS<n>:SPI:WIDTh? (see page 945)	<word_width> ::= integer 4-16 in NR1 format

Table 37 :SBUS<n>:UART Commands Summary

Command	Query	Options and Query Returns
:SBUS<n>:UART:BASE <base> (see page 949)	:SBUS<n>:UART:BASE? (see page 949)	<base> ::= {ASCIi BINary HEX}
:SBUS<n>:UART:BAUDrate <baudrate> (see page 950)	:SBUS<n>:UART:BAUDrate? (see page 950)	<baudrate> ::= integer from 100 to 8000000
:SBUS<n>:UART:BITOrder <bitorder> (see page 951)	:SBUS<n>:UART:BITOrder? (see page 951)	<bitorder> ::= {LSBFirst MSBFirst}
n/a	:SBUS<n>:UART:COUNT:ERRor? (see page 952)	<frame_count> ::= integer in NR1 format
:SBUS<n>:UART:COUNT:RESet (see page 953)	n/a	n/a
n/a	:SBUS<n>:UART:COUNT:RXFrames? (see page 954)	<frame_count> ::= integer in NR1 format
n/a	:SBUS<n>:UART:COUNT:TXFrames? (see page 955)	<frame_count> ::= integer in NR1 format
:SBUS<n>:UART:FRAMing <value> (see page 956)	:SBUS<n>:UART:FRAMing? (see page 956)	<value> ::= {OFF <decimal> <nondecimal>} <decimal> ::= 8-bit integer from 0-255 (0x00-0xff) <nondecimal> ::= #Hnn where n ::= {0,...,9 A,...,F} for hexadecimal <nondecimal> ::= #Bnn...n where n ::= {0 1} for binary
:SBUS<n>:UART:PARity <parity> (see page 957)	:SBUS<n>:UART:PARity? (see page 957)	<parity> ::= {EVEN ODD NONE}

Table 37 :SBUS<n>:UART Commands Summary (continued)

Command	Query	Options and Query Returns
:SBUS<n>:UART:POLarity <polarity> (see page 958)	:SBUS<n>:UART:POLarity? (see page 958)	<polarity> ::= {HIGH LOW}
:SBUS<n>:UART:SOURce:RX <source> (see page 959)	:SBUS<n>:UART:SOURce:RX? (see page 959)	<source> ::= {CHANnel<n> EXTernal} for DSO models <source> ::= {CHANnel<n> DIGital<d>} for MSO models <n> ::= 1 to (# analog channels) in NR1 format <d> ::= 0 to (# digital channels - 1) in NR1 format
:SBUS<n>:UART:SOURce:TX <source> (see page 960)	:SBUS<n>:UART:SOURce:TX? (see page 960)	<source> ::= {CHANnel<n> EXTernal} for DSO models <source> ::= {CHANnel<n> DIGital<d>} for MSO models <n> ::= 1 to (# analog channels) in NR1 format <d> ::= 0 to (# digital channels - 1) in NR1 format
:SBUS<n>:UART:TRIGger:BASE <base> (see page 961)	:SBUS<n>:UART:TRIGger:BASE? (see page 961)	<base> ::= {ASCii HEX}
:SBUS<n>:UART:TRIGger:BURSt <value> (see page 962)	:SBUS<n>:UART:TRIGger:BURSt? (see page 962)	<value> ::= {OFF 1 to 4096 in NR1 format}
:SBUS<n>:UART:TRIGger:DATA <value> (see page 963)	:SBUS<n>:UART:TRIGger:DATA? (see page 963)	<value> ::= 8-bit integer from 0-255 (0x00-0xff) in decimal, <hexadecimal>, <binary>, or <quoted_string> format <hexadecimal> ::= #Hnn where n ::= {0,...,9 A,...,F} for hexadecimal <binary> ::= #Bnn...n where n ::= {0 1} for binary <quoted_string> ::= any of the 128 valid 7-bit ASCII characters (or standard abbreviations)
:SBUS<n>:UART:TRIGger:IDLE <time_value> (see page 964)	:SBUS<n>:UART:TRIGger:IDLE? (see page 964)	<time_value> ::= time from 1 us to 10 s in NR3 format
:SBUS<n>:UART:TRIGger:QUALifier <value> (see page 965)	:SBUS<n>:UART:TRIGger:QUALifier? (see page 965)	<value> ::= {EQUal NOTequal GREATERthan LESSthan}

Table 37 :SBUS<n>:UART Commands Summary (continued)

Command	Query	Options and Query Returns
:SBUS<n>:UART:TRIGger :TYPE <value> (see page 966)	:SBUS<n>:UART:TRIGger :TYPE? (see page 966)	<value> ::= {RStArt RStOp RDATa RD1 RD0 RDX PARityerror TStArt TStOp TDATa TD1 TD0 TDX}
:SBUS<n>:UART:WIDTh <width> (see page 967)	:SBUS<n>:UART:WIDTh? (see page 967)	<width> ::= {5 6 7 8 9}

Table 38 General :SEARCh Commands Summary

Command	Query	Options and Query Returns
n/a	:SEARCh:COUNT? (see page 971)	<count> ::= an integer count value
:SEARCh:EVENT <event_number> (see page 972)	:SEARCh:EVENT? (see page 972)	<event_number> ::= the integer number of a found search event
:SEARCh:MODE <value> (see page 973)	:SEARCh:MODE? (see page 973)	<value> ::= {EDGE GLITCh RUNT TRANSition SERIAL{1 2} PEAK}
:SEARCh:STATe <value> (see page 974)	:SEARCh:STATe? (see page 974)	<value> ::= {{0 OFF} {1 ON}}

Table 39 :SEARCh:EDGE Commands Summary

Command	Query	Options and Query Returns
:SEARCh:EDGE:SLOPe <slope> (see page 976)	:SEARCh:EDGE:SLOPe? (see page 976)	<slope> ::= {POSitive NEGative EITHer}
:SEARCh:EDGE:SOURce <source> (see page 977)	:SEARCh:EDGE:SOURce? (see page 977)	<source> ::= CHANnel<n> <n> ::= 1 to (# analog channels) in NR1 format

Table 40 :SEARCH:GLITCh Commands Summary

Command	Query	Options and Query Returns
:SEARCH:GLITCh:GREate rthan <greater_than_time>[s uffix] (see page 979)	:SEARCH:GLITCh:GREate rthan? (see page 979)	<greater_than_time> ::= floating-point number in NR3 format [suffix] ::= {s ms us ns ps}
:SEARCH:GLITCh:LESSt han <less_than_time>[suff ix] (see page 980)	:SEARCH:GLITCh:LESSt han? (see page 980)	<less_than_time> ::= floating-point number in NR3 format [suffix] ::= {s ms us ns ps}
:SEARCH:GLITCh:POLari ty <polarity> (see page 981)	:SEARCH:GLITCh:POLari ty? (see page 981)	<polarity> ::= {POSitive NEGative}
:SEARCH:GLITCh:QUALif ier <qualifier> (see page 982)	:SEARCH:GLITCh:QUALif ier? (see page 982)	<qualifier> ::= {GREaterthan LESSthan RANGE}
:SEARCH:GLITCh:RANGE <less_than_time>[suff ix], <greater_than_time>[s uffix] (see page 983)	:SEARCH:GLITCh:RANGE? (see page 983)	<less_than_time> ::= 15 ns to 10 seconds in NR3 format <greater_than_time> ::= 10 ns to 9.99 seconds in NR3 format [suffix] ::= {s ms us ns ps}
:SEARCH:GLITCh:SOURce <source> (see page 984)	:SEARCH:GLITCh:SOURce ? (see page 984)	<source> ::= CHANNEL<n> <n> ::= 1 to (# analog channels) in NR1 format

Table 41 :SEARCH:PEAK Commands Summary

Command	Query	Options and Query Returns
:SEARCH:PEAK:EXCursio n <delta_level> (see page 986)	:SEARCH:PEAK:EXCursio n? (see page 986)	<delta_level> ::= required change in level to be recognized as a peak, in NR3 format.
:SEARCH:PEAK:NPEaks <number> (see page 987)	:SEARCH:PEAK:NPEaks? (see page 987)	<number> ::= max number of peaks to find, 1-11 in NR1 format.

Table 41 :SEARCH:PEAK Commands Summary (continued)

Command	Query	Options and Query Returns
:SEARCH:PEAK:SOURce <source> (see page 988)	:SEARCH:PEAK:SOURce? (see page 988)	<source> ::= {FUNCTION<m> MATH<m>} (must be an FFT waveform) <m> ::= 1 to 4 in NR1 format
:SEARCH:PEAK:THReshol d <level> (see page 989)	:SEARCH:PEAK:THReshol d? (see page 989)	<level> ::= necessary level to be considered a peak, in NR3 format.

Table 42 :SEARCH:RUNT Commands Summary

Command	Query	Options and Query Returns
:SEARCH:RUNT:POLarity <polarity> (see page 991)	:SEARCH:RUNT:POLarity ? (see page 991)	<polarity> ::= {POSitive NEGative EITHER}
:SEARCH:RUNT:QUALifier <qualifier> (see page 992)	:SEARCH:RUNT:QUALifier? (see page 992)	<qualifier> ::= {GREaterthan LESSthan NONE}
:SEARCH:RUNT:SOURce <source> (see page 993)	:SEARCH:RUNT:SOURce? (see page 993)	<source> ::= CHANNEL<n> <n> ::= 1 to (# analog channels) in NR1 format
:SEARCH:RUNT:TIME <time>[suffix] (see page 994)	:SEARCH:RUNT:TIME? (see page 994)	<time> ::= floating-point number in NR3 format [suffix] ::= {s ms us ns ps}

Table 43 :SEARCH:TRANSITION Commands Summary

Command	Query	Options and Query Returns
:SEARCH:TRANSition:QU ALifier <qualifier> (see page 996)	:SEARCH:TRANSition:QU ALifier? (see page 996)	<qualifier> ::= {GREaterthan LESSthan}
:SEARCH:TRANSition:SL OPe <slope> (see page 997)	:SEARCH:TRANSition:SL OPe? (see page 997)	<slope> ::= {NEGative POSitive}

Table 43 :SEARCH:TRANSition Commands Summary (continued)

Command	Query	Options and Query Returns
:SEARCH:TRANSition:SOURCE <source> (see page 998)	:SEARCH:TRANSition:SOURCE? (see page 998)	<source> ::= CHANNEL<n> <n> ::= 1 to (# analog channels) in NR1 format
:SEARCH:TRANSition:TIME <time>[suffix] (see page 999)	:SEARCH:TRANSition:TIME? (see page 999)	<time> ::= floating-point number in NR3 format [suffix] ::= {s ms us ns ps}

Table 44 :SEARCH:SERial:A429 Commands Summary

Command	Query	Options and Query Returns
:SEARCH:SERial:A429:LABEL <value> (see page 1001)	:SEARCH:SERial:A429:LABEL? (see page 1001)	<value> ::= 8-bit integer in decimal, <hex>, <octal>, or <string> from 0-255 <hex> ::= #Hnn where n ::= {0,...,9 A,...,F} <octal> ::= #Qnnn where n ::= {0,...,7} <string> ::= "0xnn" where n ::= {0,...,9 A,...,F}
:SEARCH:SERial:A429:MODE <condition> (see page 1002)	:SEARCH:SERial:A429:MODE? (see page 1002)	<condition> ::= {LABEL LBITs PERRor WERRor GERRor WGERrors ALLerrors}
:SEARCH:SERial:A429:PATTERN:DATA <string> (see page 1003)	:SEARCH:SERial:A429:PATTERN:DATA? (see page 1003)	<string> ::= "nn...n" where n ::= {0 1}, length depends on FORMat
:SEARCH:SERial:A429:PATTERN:SDI <string> (see page 1004)	:SEARCH:SERial:A429:PATTERN:SDI? (see page 1004)	<string> ::= "nn" where n ::= {0 1}, length always 2 bits
:SEARCH:SERial:A429:PATTERN:SSM <string> (see page 1005)	:SEARCH:SERial:A429:PATTERN:SSM? (see page 1005)	<string> ::= "nn" where n ::= {0 1}, length always 2 bits

Table 45 :SEARCH:SERIAL:CAN Commands Summary

Command	Query	Options and Query Returns
:SEARCH:SERIAL:CAN:MODE <value> (see page 1007)	:SEARCH:SERIAL:CAN:MODE? (see page 1007)	<value> ::= {IDData DATA IDRemote IDEither ERROR ACKError FORMError STUFFerror CRCError ALLerrors OVERload MESSage MSIGnal}
:SEARCH:SERIAL:CAN:PA Ttern:DATA <string> (see page 1009)	:SEARCH:SERIAL:CAN:PA Ttern:DATA? (see page 1009)	<string> ::= "0xnn...n" where n ::= {0,...,9 A,...,F X} for hexadecimal
:SEARCH:SERIAL:CAN:PA Ttern:DATA:LENGth <length> (see page 1010)	:SEARCH:SERIAL:CAN:PA Ttern:DATA:LENGth? (see page 1010)	<length> ::= integer from 1 to 8 in NR1 format
:SEARCH:SERIAL:CAN:PA Ttern:ID <string> (see page 1011)	:SEARCH:SERIAL:CAN:PA Ttern:ID? (see page 1011)	<string> ::= "0xnn...n" where n ::= {0,...,9 A,...,F X} for hexadecimal
:SEARCH:SERIAL:CAN:PA Ttern:ID:MODE <value> (see page 1012)	:SEARCH:SERIAL:CAN:PA Ttern:ID:MODE? (see page 1012)	<value> ::= {STANdard EXTended}
:SEARCH:SERIAL:CAN:SY MBolic:MESSage <name> (see page 1013)	:SEARCH:SERIAL:CAN:SY MBolic:MESSage? (see page 1013)	<name> ::= quoted ASCII string
:SEARCH:SERIAL:CAN:SY MBolic:SIGNal <name> (see page 1014)	:SEARCH:SERIAL:CAN:SY MBolic:SIGNal? (see page 1014)	<name> ::= quoted ASCII string
:SEARCH:SERIAL:CAN:SY MBolic:VALue <data> (see page 1015)	:SEARCH:SERIAL:CAN:SY MBolic:VALue? (see page 1015)	<data> ::= value in NR3 format

Table 46 :SEARCH:SERIAL:FLEXray Commands Summary

Command	Query	Options and Query Returns
:SEARCH:SERIAL:FLEXray:CYCLE <cycle> (see page 1017)	:SEARCH:SERIAL:FLEXray:CYCLE? (see page 1017)	<cycle> ::= {ALL <cycle #>} <cycle #> ::= integer from 0-63
:SEARCH:SERIAL:FLEXray:DATA <string> (see page 1018)	:SEARCH:SERIAL:FLEXray:DATA? (see page 1018)	<string> ::= "0xnn...n" where n ::= {0,...,9 A,...,F X}
:SEARCH:SERIAL:FLEXray:DATA:LENGth <length> (see page 1019)	:SEARCH:SERIAL:FLEXray:DATA:LENGth? (see page 1019)	<length> ::= integer from 1 to 12 in NR1 format

Table 46 :SEARCH:SERIAL:FLEXray Commands Summary (continued)

Command	Query	Options and Query Returns
:SEARCH:SERIAL:FLEXray:FRAME <frame id> (see page 1020)	:SEARCH:SERIAL:FLEXray:FRAME? (see page 1020)	<frame_id> ::= {ALL <frame #>} <frame #> ::= integer from 1-2047
:SEARCH:SERIAL:FLEXray:MODE <value> (see page 1021)	:SEARCH:SERIAL:FLEXray:MODE? (see page 1021)	<value> ::= {FRAME CYCLE DATA HERRor FERRor AERRor}

Table 47 :SEARCH:SERIAL:I2S Commands Summary

Command	Query	Options and Query Returns
:SEARCH:SERIAL:I2S:AUDIO <audio_ch> (see page 1023)	:SEARCH:SERIAL:I2S:AUDIO? (see page 1023)	<audio_ch> ::= {RIGHT LEFT EITHER}
:SEARCH:SERIAL:I2S:MODE <value> (see page 1024)	:SEARCH:SERIAL:I2S:MODE? (see page 1024)	<value> ::= {EQUAL NOTequal LESSthan GREATERthan INRange OUTRange}
:SEARCH:SERIAL:I2S:PARTtern:DATA <string> (see page 1025)	:SEARCH:SERIAL:I2S:PARTtern:DATA? (see page 1025)	<string> ::= "n" where n ::= 32-bit integer in signed decimal when <base> = DECimal <string> ::= "nn...n" where n ::= {0 1 X} when <base> = BINary <string> ::= "0xnn...n" where n ::= {0,...,9 A,...,F X} when <base> = HEX
:SEARCH:SERIAL:I2S:PARTtern:FORMat <base> (see page 1026)	:SEARCH:SERIAL:I2S:PARTtern:FORMat? (see page 1026)	<base> ::= {BINary HEX DECimal}
:SEARCH:SERIAL:I2S:RANGE <lower>, <upper> (see page 1027)	:SEARCH:SERIAL:I2S:RANGE? (see page 1027)	<lower> ::= 32-bit integer in signed decimal, <nondecimal>, or <string> <upper> ::= 32-bit integer in signed decimal, <nondecimal>, or <string> <nondecimal> ::= #Hnn...n where n ::= {0,...,9 A,...,F} for hexadecimal <nondecimal> ::= #Bnn...n where n ::= {0 1} for binary <string> ::= "0xnn...n" where n ::= {0,...,9 A,...,F} for hexadecimal

Table 48 :SEARCH:SERIAL:IIC Commands Summary

Command	Query	Options and Query Returns
:SEARCH:SERIAL:IIC:MODE <value> (see page 1029)	:SEARCH:SERIAL:IIC:MODE? (see page 1029)	<value> ::= { READ7 WRITE7 NACKnowledge ANACK R7Data2 W7Data2 REStart READEprom }
:SEARCH:SERIAL:IIC:PA TTern:ADDRESS <value> (see page 1031)	:SEARCH:SERIAL:IIC:PA TTern:ADDRESS? (see page 1031)	<value> ::= integer or <string> <string> ::= "0xnn" n ::= {0,...,9 A,...,F}
:SEARCH:SERIAL:IIC:PA TTern:DATA <value> (see page 1032)	:SEARCH:SERIAL:IIC:PA TTern:DATA? (see page 1032)	<value> ::= integer or <string> <string> ::= "0xnn" n ::= {0,...,9 A,...,F}
:SEARCH:SERIAL:IIC:PA TTern:DATA2 <value> (see page 1033)	:SEARCH:SERIAL:IIC:PA TTern:DATA2? (see page 1033)	<value> ::= integer or <string> <string> ::= "0xnn" n ::= {0,...,9 A,...,F}
:SEARCH:SERIAL:IIC:QUALifier <value> (see page 1034)	:SEARCH:SERIAL:IIC:QUALifier? (see page 1034)	<value> ::= {EQUal NOTequal LESSthan GREATERthan}

Table 49 :SEARCH:SERIAL:LIN Commands Summary

Command	Query	Options and Query Returns
:SEARCH:SERIAL:LIN:ID <value> (see page 1036)	:SEARCH:SERIAL:LIN:ID ? (see page 1036)	<value> ::= 7-bit integer in decimal, <nondecimal>, or <string> from 0-63 or 0x00-0x3f (with Option AMS) <nondecimal> ::= #Hnn where n ::= {0,...,9 A,...,F} for hexadecimal <nondecimal> ::= #Bnn...n where n ::= {0 1} for binary <string> ::= "0xnn" where n ::= {0,...,9 A,...,F} for hexadecimal
:SEARCH:SERIAL:LIN:MODE <value> (see page 1037)	:SEARCH:SERIAL:LIN:MODE? (see page 1037)	<value> ::= {ID DATA ERRor}

Table 49 :SEARCH:SERIAL:LIN Commands Summary (continued)

Command	Query	Options and Query Returns
:SEARCH:SERIAL:LIN:PA TTern:DATA <string> (see page 1038)	:SEARCH:SERIAL:LIN:PA TTern:DATA? (see page 1038)	When :SEARCH:SERIAL:LIN:PATtern:FORMa t DECimal, <string> ::= "n" where n ::= 32-bit integer in unsigned decimal, returns "\$" if data has any don't cares When :SEARCH:SERIAL:LIN:PATtern:FORMa t HEX, <string> ::= "0xnn...n" where n ::= {0,...,9 A,...,F X }
:SEARCH:SERIAL:LIN:PA TTern:DATA:LENGth <length> (see page 1039)	:SEARCH:SERIAL:LIN:PA TTern:DATA:LENGth? (see page 1039)	<length> ::= integer from 1 to 8 in NR1 format
:SEARCH:SERIAL:LIN:PA TTern:FORMat <base> (see page 1040)	:SEARCH:SERIAL:LIN:PA TTern:FORMat? (see page 1040)	<base> ::= {HEX DECimal}
:SEARCH:SERIAL:LIN:SY MBolic:FRAMe <name> (see page 1041)	:SEARCH:SERIAL:LIN:SY MBolic:FRAMe? (see page 1041)	<name> ::= quoted ASCII string
:SEARCH:SERIAL:LIN:SY MBolic:SIGNal <name> (see page 1042)	:SEARCH:SERIAL:LIN:SY MBolic:SIGNal? (see page 1042)	<name> ::= quoted ASCII string
:SEARCH:SERIAL:LIN:SY MBolic:VALue <data> (see page 1043)	:SEARCH:SERIAL:LIN:SY MBolic:VALue? (see page 1043)	<data> ::= value in NR3 format

Table 50 :SEARCH:SERIAL:M1553 Commands Summary

Command	Query	Options and Query Returns
:SEARCH:SERIAL:M1553: MODE <value> (see page 1045)	:SEARCH:SERIAL:M1553: MODE? (see page 1045)	<value> ::= {DStArt CStArt RTA RTA11 PERRor SERRor MERRor}

Table 50 :SEARCH:SERIAL:M1553 Commands Summary (continued)

Command	Query	Options and Query Returns
:SEARCH:SERIAL:M1553:PATTERN:DATA <string> (see page 1046)	:SEARCH:SERIAL:M1553:PATTERN:DATA? (see page 1046)	<string> ::= "nn...n" where n ::= {0 1}
:SEARCH:SERIAL:M1553:RTA <value> (see page 1047)	:SEARCH:SERIAL:M1553:RTA? (see page 1047)	<value> ::= 5-bit integer in decimal, <hexadecimal>, <binary>, or <string> from 0-31 <hexadecimal> ::= #Hnn where n ::= {0,...,9 A,...,F} <binary> ::= #Bnn...n where n ::= {0 1} for binary <string> ::= "0xnn" where n ::= {0,...,9 A,...,F}

Table 51 :SEARCH:SERIAL:SENT Commands Summary

Command	Query	Options and Query Returns
:SEARCH:SERIAL:SENT:FAST:DATA <string> (see page 1049)	:SEARCH:SERIAL:SENT:FAST:DATA? (see page 1049)	<string> ::= "0xn..." where n ::= {0,...,9 A,...,F X \$}
:SEARCH:SERIAL:SENT:MODE <mode> (see page 1050)	:SEARCH:SERIAL:SENT:MODE? (see page 1050)	<mode> ::= {FCData SCMid SCData CRCError PPErrror}
:SEARCH:SERIAL:SENT:SLOW:DATA <data> (see page 1051)	:SEARCH:SERIAL:SENT:SLOW:DATA? (see page 1051)	<data> ::= from -1 (don't care) to 65535, in NR1 format.
:SEARCH:SERIAL:SENT:SLOW:ID <id> (see page 1052)	:SEARCH:SERIAL:SENT:SLOW:ID? (see page 1052)	<id> ::= from -1 (don't care) to 255, in NR1 format.

Table 52 :SEARCH:SERIAL:SPI Commands Summary

Command	Query	Options and Query Returns
:SEARCH:SERIAL:SPI:MODE <value> (see page 1054)	:SEARCH:SERIAL:SPI:MODE? (see page 1054)	<value> ::= {MOSI MISO}
:SEARCH:SERIAL:SPI:PATTERN:DATA <string> (see page 1055)	:SEARCH:SERIAL:SPI:PATTERN:DATA? (see page 1055)	<string> ::= "0xnn...n" where n ::= {0,...,9 A,...,F X}
:SEARCH:SERIAL:SPI:PATTERN:WIDTH <width> (see page 1056)	:SEARCH:SERIAL:SPI:PATTERN:WIDTH? (see page 1056)	<width> ::= integer from 1 to 10

Table 53 :SEARCH:SERIAL:UART Commands Summary

Command	Query	Options and Query Returns
:SEARCH:SERIAL:UART:DATA <value> (see page 1058)	:SEARCH:SERIAL:UART:DATA? (see page 1058)	<value> ::= 8-bit integer from 0-255 (0x00-0xff) in decimal, <hexadecimal>, <binary>, or <quoted_string> format <hexadecimal> ::= #Hnn where n ::= {0,...,9 A,...,F} for hexadecimal <binary> ::= #Bnn...n where n ::= {0 1} for binary <quoted_string> ::= any of the 128 valid 7-bit ASCII characters (or standard abbreviations)
:SEARCH:SERIAL:UART:MODE <value> (see page 1059)	:SEARCH:SERIAL:UART:MODE? (see page 1059)	<value> ::= {RDATa RD1 RD0 RDX TDATa TD1 TD0 TDX PARityerror AERRor}
:SEARCH:SERIAL:UART:QUALifier <value> (see page 1060)	:SEARCH:SERIAL:UART:QUALifier? (see page 1060)	<value> ::= {EQUal NOTequal GREATERthan LESSthan}

Table 54 :SYSTEM Commands Summary

Command	Query	Options and Query Returns
:SYSTEM:DATE <date> (see page 1063)	:SYSTEM:DATE? (see page 1063)	<date> ::= <year>,<month>,<day> <year> ::= 4-digit year in NR1 format <month> ::= {1,...,12 JANuary FEBruary MARch APRil MAY JUNE JULy AUGust SEPTember OCTober NOVember DECember} <day> ::= {1,..31}
:SYSTEM:DSP <string> (see page 1064)	n/a	<string> ::= up to 75 characters as a quoted ASCII string
n/a	:SYSTEM:ERROR? (see page 1065)	<error> ::= an integer error code <error string> ::= quoted ASCII string. See Error Messages (see page 1341).
:SYSTEM:LOCK <value> (see page 1066)	:SYSTEM:LOCK? (see page 1066)	<value> ::= {{1 ON} {0 OFF}}

Table 54 :SYSTEM Commands Summary (continued)

Command	Query	Options and Query Returns
:SYSTEM:PERSONa[:MANu facturer] <manufacturer_string> (see page 1067)	:SYSTEM:PERSONa[:MANu facturer]? (see page 1067)	<manufacturer_string> ::= quoted ASCII string, up to 63 characters
:SYSTEM:PERSONa[:MANu facturer]:Default (see page 1068)	n/a	Sets manufacturer string to "KEYSIGHT TECHNOLOGIES"
:SYSTEM:PRESet (see page 1069)	n/a	See :SYSTEM:PRESet (see page 1069)
:SYSTEM:PROTection:LO CK <value> (see page 1072)	:SYSTEM:PROTection:LO CK? (see page 1072)	<value> ::= {{1 ON} {0 OFF}}
:SYSTEM:RLOGger <setting>[,<file_name >[,<write_mode>]] (see page 1073)	n/a	<setting> ::= {{0 OFF} {1 ON}} <file_name> ::= quoted ASCII string <write_mode> ::= {CREate APPend}
:SYSTEM:RLOGger:DESti nation <dest> (see page 1074)	:SYSTEM:RLOGger:DESti nation? (see page 1074)	<dest> ::= {FILE SCReen BOTH}
:SYSTEM:RLOGger:DISPl ay {{0 OFF} {1 ON}} (see page 1075)	:SYSTEM:RLOGger:DISPl ay? (see page 1075)	<setting> ::= {0 1}
:SYSTEM:RLOGger:FNAME <file_name> (see page 1076)	:SYSTEM:RLOGger:FNAME ? (see page 1076)	<file_name> ::= quoted ASCII string
:SYSTEM:RLOGger:STATe {{0 OFF} {1 ON}} (see page 1077)	:SYSTEM:RLOGger:STATe ? (see page 1077)	<setting> ::= {0 1}
:SYSTEM:RLOGger:TRANs parent {{0 OFF} {1 ON}} (see page 1078)	:SYSTEM:RLOGger:TRANs parent? (see page 1078)	<setting> ::= {0 1}
:SYSTEM:RLOGger:WMOde <write_mode> (see page 1079)	:SYSTEM:RLOGger:WMOde ? (see page 1079)	<write_mode> ::= {CREate APPend}
:SYSTEM:SETup <setup_data> (see page 1080)	:SYSTEM:SETup? (see page 1080)	<setup_data> ::= data in IEEE 488.2 # format.

Table 54 :SYSTem Commands Summary (continued)

Command	Query	Options and Query Returns
:SYSTem:TIME <time> (see page 1082)	:SYSTem:TIME? (see page 1082)	<time> ::= hours, minutes, seconds in NR1 format
:SYSTem:TOUCh {{1 ON} {0 OFF}} (see page 1083)	:SYSTem:TOUCh? (see page 1083)	{1 0}

Table 55 :TIMebase Commands Summary

Command	Query	Options and Query Returns
:TIMebase:MODE <value> (see page 1087)	:TIMebase:MODE? (see page 1087)	<value> ::= {MAIN WINDow XY ROLL}
:TIMebase:POSition <pos> (see page 1088)	:TIMebase:POSition? (see page 1088)	<pos> ::= time from the trigger event to the display reference point in NR3 format
:TIMebase:RANGe <range_value> (see page 1089)	:TIMebase:RANGe? (see page 1089)	<range_value> ::= time for 10 div in seconds in NR3 format
:TIMebase:REFerence {LEFT CENTer RIGHT CUSTom} (see page 1090)	:TIMebase:REFerence? (see page 1090)	<return_value> ::= {LEFT CENTer RIGHT CUSTom}
:TIMebase:REFerence:L OCation <loc> (see page 1091)	:TIMebase:REFerence:L OCation? (see page 1091)	<loc> ::= 0.0 to 1.0 in NR3 format
:TIMebase:SCALe <scale_value> (see page 1092)	:TIMebase:SCALe? (see page 1092)	<scale_value> ::= time/div in seconds in NR3 format
:TIMebase:VERNier {{0 OFF} {1 ON}} (see page 1093)	:TIMebase:VERNier? (see page 1093)	{0 1}
:TIMebase:WINDow:POSi tion <pos> (see page 1094)	:TIMebase:WINDow:POSi tion? (see page 1094)	<pos> ::= time from the trigger event to the zoomed view reference point in NR3 format
:TIMebase:WINDow:RANG e <range_value> (see page 1095)	:TIMebase:WINDow:RANG e? (see page 1095)	<range value> ::= range value in seconds in NR3 format for the zoomed window
:TIMebase:WINDow:SCAL e <scale_value> (see page 1096)	:TIMebase:WINDow:SCAL e? (see page 1096)	<scale_value> ::= scale value in seconds in NR3 format for the zoomed window

Table 56 General :TRIGger Commands Summary

Command	Query	Options and Query Returns
:TRIGger:FORCe (see page 1100)	n/a	n/a
:TRIGger:HFReject {{0 OFF} {1 ON}} (see page 1101)	:TRIGger:HFReject? (see page 1101)	{0 1}
:TRIGger:HOLDoff <holdoff_time> (see page 1102)	:TRIGger:HOLDoff? (see page 1102)	<holdoff_time> ::= 60 ns to 10 s in NR3 format
:TRIGger:LEVel:ASETup (see page 1103)	n/a	n/a
:TRIGger:LEVel:HIGH <level>, <source> (see page 1104)	:TRIGger:LEVel:HIGH? <source> (see page 1104)	<level> ::= .75 x full-scale voltage from center screen in NR3 format. <source> ::= CHANnel<n> <n> ::= 1 to (# analog channels) in NR1 format
:TRIGger:LEVel:LOW <level>, <source> (see page 1105)	:TRIGger:LEVel:LOW? <source> (see page 1105)	<level> ::= .75 x full-scale voltage from center screen in NR3 format. <source> ::= CHANnel<n> <n> ::= 1 to (# analog channels) in NR1 format
:TRIGger:MODE <mode> (see page 1106)	:TRIGger:MODE? (see page 1106)	<mode> ::= {EDGE GLITCh PATtern TV DELay EBURst OR RUNT SHOLd TRANSition SBUS{1 2}} <return_value> ::= {<mode> <none>} <none> ::= query returns "NONE" if the :TIMEbase:MODE is ROLL or XY
:TRIGger:NREJect {{0 OFF} {1 ON}} (see page 1107)	:TRIGger:NREJect? (see page 1107)	{0 1}
:TRIGger:SWEep <sweep> (see page 1108)	:TRIGger:SWEep? (see page 1108)	<sweep> ::= {AUTO NORMal}

Table 57 :TRIGger:DElay Commands Summary

Command	Query	Options and Query Returns
:TRIGger:DElay:ARM:SL OPe <slope> (see page 1110)	:TRIGger:DElay:ARM:SL OPe? (see page 1110)	<slope> ::= {NEGative POSitive}
:TRIGger:DElay:ARM:SO URce <source> (see page 1111)	:TRIGger:DElay:ARM:SO URce? (see page 1111)	<source> ::= {CHANnel<n> DIGital<d>} <n> ::= 1 to (# analog channels) in NR1 format <d> ::= 0 to (# digital channels - 1) in NR1 format
:TRIGger:DElay:TDElay :TIME <time_value> (see page 1112)	:TRIGger:DElay:TDElay :TIME? (see page 1112)	<time_value> ::= time in seconds in NR3 format
:TRIGger:DElay:TRIGge r:COUNT <count> (see page 1113)	:TRIGger:DElay:TRIGge r:COUNT? (see page 1113)	<count> ::= integer in NR1 format
:TRIGger:DElay:TRIGge r:SLOPe <slope> (see page 1114)	:TRIGger:DElay:TRIGge r:SLOPe? (see page 1114)	<slope> ::= {NEGative POSitive}
:TRIGger:DElay:TRIGge r:SOURce <source> (see page 1115)	:TRIGger:DElay:TRIGge r:SOURce? (see page 1115)	<source> ::= {CHANnel<n> DIGital<d>} <n> ::= 1 to (# analog channels) in NR1 format <d> ::= 0 to (# digital channels - 1) in NR1 format

Table 58 :TRIGger:EBURst Commands Summary

Command	Query	Options and Query Returns
:TRIGger:EBURst:COUNT <count> (see page 1117)	:TRIGger:EBURst:COUNT ? (see page 1117)	<count> ::= integer in NR1 format
:TRIGger:EBURst:IDLE <time_value> (see page 1118)	:TRIGger:EBURst:IDLE? (see page 1118)	<time_value> ::= time in seconds in NR3 format

Table 58 :TRIGger:EBURst Commands Summary (continued)

Command	Query	Options and Query Returns
:TRIGger:EBURst:SLOPe <slope> (see page 1119)	:TRIGger:EBURst:SLOPe ? (see page 1119)	<slope> ::= {NEGative POSitive}
:TRIGger:EBURst:SOURc e <source> (see page 1120)	:TRIGger:EBURst:SOURc e? (see page 1120)	<source> ::= {CHANnel<n> DIGital<d>} <n> ::= 1 to (# analog channels) in NR1 format <d> ::= 0 to (# digital channels - 1) in NR1 format

Table 59 :TRIGger[:EDGE] Commands Summary

Command	Query	Options and Query Returns
:TRIGger[:EDGE]:COUPl ing {AC DC LFReject} (see page 1122)	:TRIGger[:EDGE]:COUPl ing? (see page 1122)	{AC DC LFReject}
:TRIGger[:EDGE]:LEVel <level> [, <source>] (see page 1123)	:TRIGger[:EDGE]:LEVel ? [<source>] (see page 1123)	For internal triggers, <level> ::= .75 x full-scale voltage from center screen in NR3 format. For external triggers, <level> ::= ±(external range setting) in NR3 format. For digital channels (MSO models), <level> ::= ±8 V. <source> ::= {CHANnel<n> EXTernal} for DSO models <source> ::= {CHANnel<n> DIGital<d> EXTernal } for MSO models <n> ::= 1 to (# analog channels) in NR1 format <d> ::= 0 to (# digital channels - 1) in NR1 format
:TRIGger[:EDGE]:REJec t {OFF LFReject HFReject} (see page 1124)	:TRIGger[:EDGE]:REJec t? (see page 1124)	{OFF LFReject HFReject}

Table 59 :TRIGger[:EDGE] Commands Summary (continued)

Command	Query	Options and Query Returns
:TRIGger[:EDGE]:SLOPe <polarity> (see page 1125)	:TRIGger[:EDGE]:SLOPe ? (see page 1125)	<polarity> ::= {POSitive NEGative EITHER ALTernate}
:TRIGger[:EDGE]:SOURc e <source> (see page 1126)	:TRIGger[:EDGE]:SOURc e? (see page 1126)	<source> ::= {CHANnel<n> EXTernal LINE WGEN} for the DSO models <source> ::= {CHANnel<n> DIGital<d> EXTernal LINE WGEN} for the MSO models <n> ::= 1 to (# analog channels) in NR1 format <d> ::= 0 to (# digital channels - 1) in NR1 format

Table 60 :TRIGger:GLITCh Commands Summary

Command	Query	Options and Query Returns
:TRIGger:GLITCh:GREAt erthan <greater_than_time>[s uffix] (see page 1129)	:TRIGger:GLITCh:GREAt erthan? (see page 1129)	<greater_than_time> ::= floating-point number in NR3 format [suffix] ::= {s ms us ns ps}
:TRIGger:GLITCh:LESSt han <less_than_time>[suff ix] (see page 1130)	:TRIGger:GLITCh:LESSt han? (see page 1130)	<less_than_time> ::= floating-point number in NR3 format [suffix] ::= {s ms us ns ps}
:TRIGger:GLITCh:LEVEl <level> [<source>] (see page 1131)	:TRIGger:GLITCh:LEVEl ? (see page 1131)	For internal triggers, <level> ::= .75 x full-scale voltage from center screen in NR3 format. For external triggers (DSO models), <level> ::= ±(external range setting) in NR3 format. For digital channels (MSO models), <level> ::= ±8 V. <source> ::= {CHANnel<n> EXTernal} for DSO models <source> ::= {CHANnel<n> DIGital<d>} for MSO models <n> ::= 1 to (# analog channels) in NR1 format <d> ::= 0 to (# digital channels - 1) in NR1 format

Table 60 :TRIGger:GLITch Commands Summary (continued)

Command	Query	Options and Query Returns
:TRIGger:GLITch:POLarity <polarity> (see page 1132)	:TRIGger:GLITch:POLarity? (see page 1132)	<polarity> ::= {POSitive NEGative}
:TRIGger:GLITch:QUALifier <qualifier> (see page 1133)	:TRIGger:GLITch:QUALifier? (see page 1133)	<qualifier> ::= {GREATERthan LESSthan RANGE}
:TRIGger:GLITch:RANGE <less_than_time>[suffix], <greater_than_time>[suffix] (see page 1134)	:TRIGger:GLITch:RANGE? (see page 1134)	<less_than_time> ::= 15 ns to 10 seconds in NR3 format <greater_than_time> ::= 10 ns to 9.99 seconds in NR3 format [suffix] ::= {s ms us ns ps}
:TRIGger:GLITch:SOURce <source> (see page 1135)	:TRIGger:GLITch:SOURce? (see page 1135)	<source> ::= {CHANnel<n> DIGital<d>} <n> ::= 1 to (# analog channels) in NR1 format <d> ::= 0 to (# digital channels - 1) in NR1 format

Table 61 :TRIGger:NFC Commands Summary

Command	Query	Options and Query Returns
:TRIGger:NFC:AEVEnt <arm_event> (see page 1137)	:TRIGger:NFC:AEVEnt? (see page 1137)	<arm_event> ::= {NONE ASReq AALLreq AEITher BSReq BALLreq BEITher FSReq}
n/a	:TRIGger:NFC:ATTTime? (see page 1138)	<time> ::= seconds in NR3 format
:TRIGger:NFC:SOURce <source> (see page 1139)	:TRIGger:NFC:SOURce? (see page 1139)	<source> ::= CHANnel<n> <n> ::= 1 to (# analog channels) in NR1 format
:TRIGger:NFC:STANdard <standard> (see page 1140)	:TRIGger:NFC:STANdard? (see page 1140)	<standard> ::= {{A A106} {B B106} F212 F424}
:TRIGger:NFC:TEVEnt <trigger_event> (see page 1141)	:TRIGger:NFC:TEVEnt? (see page 1141)	<trigger_event> ::= {ATRigger ASReq AALLreq AEITher ASDDreq BSReq BALLreq BEITher BATtrib FSReq FAREq FPReamble}
n/a	:TRIGger:NFC:TIMEout? (see page 1143)	{0 1}

Table 61 :TRIGger:NFC Commands Summary (continued)

Command	Query	Options and Query Returns
:TRIGger:NFC:TIMEout:ENABle {{0 OFF} {1 ON}} (see page 1144)	:TRIGger:NFC:TIMEout:ENABle? (see page 1144)	{0 1}
:TRIGger:NFC:TIMEout:TIME <time> (see page 1145)	:TRIGger:NFC:TIMEout:TIME? (see page 1145)	<time> ::= seconds in NR3 format

Table 62 :TRIGger:OR Commands Summary

Command	Query	Options and Query Returns
:TRIGger:OR <string> (see page 1147)	:TRIGger:OR? (see page 1147)	<string> ::= "nn...n" where n ::= {R F E X} R = rising edge, F = falling edge, E = either edge, X = don't care. Each character in the string is for an analog or digital channel as shown on the front panel display.

Table 63 :TRIGger:PATtern Commands Summary

Command	Query	Options and Query Returns
:TRIGger:PATtern <string>[,<edge_source>,<edge>] (see page 1149)	:TRIGger:PATtern? (see page 1150)	<string> ::= "nn...n" where n ::= {0 1 X R F} when <base> = ASCII <string> ::= "0xnn...n" where n ::= {0,...,9 A,...,F X \$} when <base> = HEX <edge_source> ::= {CHANnel<n> NONE} for DSO models <edge_source> ::= {CHANnel<n> DIGital<d> NONE} for MSO models <n> ::= 1 to (# analog channels) in NR1 format <d> ::= 0 to (# digital channels - 1) in NR1 format <edge> ::= {POSitive NEGative}
:TRIGger:PATtern:FORM at <base> (see page 1151)	:TRIGger:PATtern:FORM at? (see page 1151)	<base> ::= {ASCII HEX}

Table 63 :TRIGger:PATtern Commands Summary (continued)

Command	Query	Options and Query Returns
:TRIGger:PATtern:GREa terthan <greater_than_time>[s uffix] (see page 1152)	:TRIGger:PATtern:GREa terthan? (see page 1152)	<greater_than_time> ::= floating-point number in NR3 format [suffix] ::= {s ms us ns ps}
:TRIGger:PATtern:LESS than <less_than_time>[suff ix] (see page 1153)	:TRIGger:PATtern:LESS than? (see page 1153)	<less_than_time> ::= floating-point number in NR3 format [suffix] ::= {s ms us ns ps}
:TRIGger:PATtern:QUAL ifier <qualifier> (see page 1154)	:TRIGger:PATtern:QUAL ifier? (see page 1154)	<qualifier> ::= {ENTERed GREaterthan LESSthan INRange OUTRange TIMEout}
:TRIGger:PATtern:RANG e <less_than_time>[suff ix], <greater_than_time>[s uffix] (see page 1155)	:TRIGger:PATtern:RANG e? (see page 1155)	<less_than_time> ::= 15 ns to 10 seconds in NR3 format <greater_than_time> ::= 10 ns to 9.99 seconds in NR3 format [suffix] ::= {s ms us ns ps}

Table 64 :TRIGger:RUNT Commands Summary

Command	Query	Options and Query Returns
:TRIGger:RUNT:POLarit y <polarity> (see page 1157)	:TRIGger:RUNT:POLarit y? (see page 1157)	<polarity> ::= {POSitive NEGative EITHER}
:TRIGger:RUNT:QUALifi er <qualifier> (see page 1158)	:TRIGger:RUNT:QUALifi er? (see page 1158)	<qualifier> ::= {GREaterthan LESSthan NONE}
:TRIGger:RUNT:SOURce <source> (see page 1159)	:TRIGger:RUNT:SOURce? (see page 1159)	<source> ::= CHANnel<n> <n> ::= 1 to (# analog channels) in NR1 format
:TRIGger:RUNT:TIME <time>[suffix] (see page 1160)	:TRIGger:RUNT:TIME? (see page 1160)	<time> ::= floating-point number in NR3 format [suffix] ::= {s ms us ns ps}

Table 65 :TRIGger:SHOLd Commands Summary

Command	Query	Options and Query Returns
:TRIGger:SHOLd:SLOPe <slope> (see page 1162)	:TRIGger:SHOLd:SLOPe? (see page 1162)	<slope> ::= {NEGative POSitive}
:TRIGger:SHOLd:SOURce :CLOCK <source> (see page 1163)	:TRIGger:SHOLd:SOURce :CLOCK? (see page 1163)	<source> ::= {CHANnel<n> DIGital<d>} <n> ::= 1 to (# analog channels) in NR1 format <d> ::= 0 to (# digital channels - 1) in NR1 format
:TRIGger:SHOLd:SOURce :DATA <source> (see page 1164)	:TRIGger:SHOLd:SOURce :DATA? (see page 1164)	<source> ::= {CHANnel<n> DIGital<d>} <n> ::= 1 to (# analog channels) in NR1 format <d> ::= 0 to (# digital channels - 1) in NR1 format
:TRIGger:SHOLd:TIME:H OLD <time>[suffix] (see page 1165)	:TRIGger:SHOLd:TIME:H OLD? (see page 1165)	<time> ::= floating-point number in NR3 format [suffix] ::= {s ms us ns ps}
:TRIGger:SHOLd:TIME:S ETUp <time>[suffix] (see page 1166)	:TRIGger:SHOLd:TIME:S ETUp? (see page 1166)	<time> ::= floating-point number in NR3 format [suffix] ::= {s ms us ns ps}

Table 66 :TRIGger:TRANSition Commands Summary

Command	Query	Options and Query Returns
:TRIGger:TRANSition:Q UALifier <qualifier> (see page 1168)	:TRIGger:TRANSition:Q UALifier? (see page 1168)	<qualifier> ::= {GREaterthan LESSthan}
:TRIGger:TRANSition:S LOPe <slope> (see page 1169)	:TRIGger:TRANSition:S LOPe? (see page 1169)	<slope> ::= {NEGative POSitive}
:TRIGger:TRANSition:S OURce <source> (see page 1170)	:TRIGger:TRANSition:S OURce? (see page 1170)	<source> ::= CHANnel<n> <n> ::= 1 to (# analog channels) in NR1 format
:TRIGger:TRANSition:T IME <time>[suffix] (see page 1171)	:TRIGger:TRANSition:T IME? (see page 1171)	<time> ::= floating-point number in NR3 format [suffix] ::= {s ms us ns ps}

Table 67 :TRIGger:TV Commands Summary

Command	Query	Options and Query Returns
:TRIGger:TV:LINE <line number> (see page 1173)	:TRIGger:TV:LINE? (see page 1173)	<line number> ::= integer in NR1 format
:TRIGger:TV:MODE <tv mode> (see page 1174)	:TRIGger:TV:MODE? (see page 1174)	<tv mode> ::= {FIELD1 FIELD2 AFIELDS ALINES LINE LFIELD1 LFIELD2 LALTERNATE}
:TRIGger:TV:POLarity <polarity> (see page 1175)	:TRIGger:TV:POLarity? (see page 1175)	<polarity> ::= {POSitive NEGative}
:TRIGger:TV:SOURce <source> (see page 1176)	:TRIGger:TV:SOURce? (see page 1176)	<source> ::= {CHANnel<n>} <n> ::= 1 to (# analog channels) in NR1 format
:TRIGger:TV:STANdard <standard> (see page 1177)	:TRIGger:TV:STANdard? (see page 1177)	<standard> ::= {NTSC PAL PALM SECam} <standard> ::= {GENeric {P480L60HZ P480} {P720L60HZ P720} {P1080L24HZ P1080} P1080L25HZ P1080L50HZ P1080L60HZ {I1080L50HZ I1080} I1080L60HZ} with extended video triggering license
:TRIGger:TV:UDTV:ENUM ber <count> (see page 1178)	:TRIGger:TV:UDTV:ENUM ber? (see page 1178)	<count> ::= edge number in NR1 format
:TRIGger:TV:UDTV:HSYN c {{0 OFF} {1 ON}} (see page 1179)	:TRIGger:TV:UDTV:HSYN c? (see page 1179)	{0 1}
:TRIGger:TV:UDTV:HTIM e <time> (see page 1180)	:TRIGger:TV:UDTV:HTIM e? (see page 1180)	<time> ::= seconds in NR3 format
:TRIGger:TV:UDTV:PGTH an <min_time> (see page 1181)	:TRIGger:TV:UDTV:PGTH an? (see page 1181)	<min_time> ::= seconds in NR3 format

Table 68 :TRIGger:USB Commands Summary

Command	Query	Options and Query Returns
:TRIGger:USB:SOURce:D MINus <source> (see page 1183)	:TRIGger:USB:SOURce:D MINus? (see page 1183)	<source> ::= {CHANnel<n> EXTernal} for the DSO models <source> ::= {CHANnel<n> DIGital<d>} for the MSO models <n> ::= 1 to (# analog channels) in NR1 format <d> ::= 0 to (# digital channels - 1) in NR1 format
:TRIGger:USB:SOURce:D PLus <source> (see page 1184)	:TRIGger:USB:SOURce:D PLus? (see page 1184)	<source> ::= {CHANnel<n> EXTernal} for the DSO models <source> ::= {CHANnel<n> DIGital<d>} for the MSO models <n> ::= 1 to (# analog channels) in NR1 format <d> ::= 0 to (# digital channels - 1) in NR1 format
:TRIGger:USB:SPEEd <value> (see page 1185)	:TRIGger:USB:SPEEd? (see page 1185)	<value> ::= {LOW FULL}
:TRIGger:USB:TRIGger <value> (see page 1186)	:TRIGger:USB:TRIGger? (see page 1186)	<value> ::= {SOP EOP ENTersuspend EXITsuspend RESet}

Table 69 :TRIGger:ZONE Commands Summary

Command	Query	Options and Query Returns
:TRIGger:ZONE:SOURce <source> (see page 1188)	:TRIGger:ZONE:SOURce? (see page 1188)	<source> ::= {CHANnel<n>} <n> ::= 1 to (# analog channels) in NR1 format
:TRIGger:ZONE:STATe { {0 OFF} {1 ON} } (see page 1189)	:TRIGger:ZONE:STATe? (see page 1189)	{0 1}
:TRIGger:ZONE<n>:MODE <mode> (see page 1190)	:TRIGger:ZONE<n>:MODE ? (see page 1190)	<mode> ::= {INTersect NOTintersect} <n> ::= 1-2 in NR1 format

Table 69 :TRIGger:ZONE Commands Summary (continued)

Command	Query	Options and Query Returns
:TRIGger:ZONE<n>:PLAC ement <width>, <height>, <x_center>, <y_center> (see page 1191)	:TRIGger:ZONE<n>:PLAC ement? (see page 1191)	<width> ::= width of zone in seconds <height> ::= height of zone in volts <x_center> ::= center of zone in seconds <y_center> ::= center of zone in volts <n> ::= 1-2 in NR1 format
n/a	:TRIGger:ZONE<n>:VALi dity? (see page 1192)	<value> ::= {VALid INValid OSCRen} <n> ::= 1-2 in NR1 format
:TRIGger:ZONE<n>:STAT e {{0 OFF} {1 ON}} (see page 1193)	:TRIGger:ZONE<n>:STAT e? (see page 1193)	{0 1} <n> ::= 1-2 in NR1 format

Table 70 :WAVEform Commands Summary

Command	Query	Options and Query Returns
:WAVEform:BYTeorder <value> (see page 1203)	:WAVEform:BYTeorder? (see page 1203)	<value> ::= {LSBFirst MSBFirst}
n/a	:WAVEform:COUNT? (see page 1204)	<count> ::= an integer from 1 to 65536 in NR1 format
n/a	:WAVEform:DATA? (see page 1205)	<binary block length bytes>, <binary data> For example, to transmit 1000 bytes of data, the syntax would be: #800001000<1000 bytes of data><NL> 8 is the number of digits that follow 00001000 is the number of bytes to be transmitted <1000 bytes of data> is the actual data
:WAVEform:FORMat <value> (see page 1207)	:WAVEform:FORMat? (see page 1207)	<value> ::= {WORD BYTE ASCII}

Table 70 :WAVEform Commands Summary (continued)

Command	Query	Options and Query Returns
:WAVEform:POINTs <# points> (see page 1208)	:WAVEform:POINTs? (see page 1208)	<# points> ::= {100 250 500 1000 <points_mode>} if waveform points mode is NORMAl <# points> ::= {100 250 500 1000 2000 ... 8000000 in 1-2-5 sequence <points_mode>} if waveform points mode is MAXimum or RAW <points_mode> ::= {NORMAl MAXimum RAW}
:WAVEform:POINTs:MODE <points_mode> (see page 1210)	:WAVEform:POINTs:MODE ? (see page 1210)	<points_mode> ::= {NORMAl MAXimum RAW}
n/a	:WAVEform:PREAmble? (see page 1212)	<preamble_block> ::= <format NR1>, <type NR1>, <points NR1>, <count NR1>, <xincrement NR3>, <xorigin NR3>, <xreference NR1>, <yincrement NR3>, <yorigin NR3>, <yreference NR1> <format> ::= an integer in NR1 format: <ul style="list-style-type: none"> • 0 for BYTE format • 1 for WORD format • 2 for ASCii format <type> ::= an integer in NR1 format: <ul style="list-style-type: none"> • 0 for NORMAl type • 1 for PEAK detect type • 3 for AVERAge type • 4 for HRESolution type <count> ::= Average count, or 1 if PEAK detect type or NORMAl; an integer in NR1 format
n/a	:WAVEform:SEGmented:COUNT? (see page 1215)	<count> ::= an integer from 2 to 1000 in NR1 format (with Option SGM)
n/a	:WAVEform:SEGmented:TAG? (see page 1216)	<time_tag> ::= in NR3 format (with Option SGM)

Table 70 :WAVeform Commands Summary (continued)

Command	Query	Options and Query Returns
:WAVeform:SOURce <source> (see page 1217)	:WAVeform:SOURce? (see page 1217)	<source> ::= {CHANnel<n> FUNction<m> MATH<m> FFT SBUS} for DSO models <source> ::= {CHANnel<n> POD{1 2} BUS{1 2} FUNction<m> MATH<m> FFT SBUS} for MSO models <n> ::= 1 to (# analog channels) in NR1 format <m> ::= 1 to (# math functions) in NR1 format
:WAVeform:SOURce:SUBS ource <subsource> (see page 1221)	:WAVeform:SOURce:SUBS ource? (see page 1221)	<subsource> ::= {{SUB0 RX MOSI} {SUB1 TX MISO}}
n/a	:WAVeform:TYPE? (see page 1222)	<return_mode> ::= {NORM PEAK AVER HRES}
:WAVeform:UNSigned {{0 OFF} {1 ON}} (see page 1223)	:WAVeform:UNSigned? (see page 1223)	{0 1}
:WAVeform:VIEW <view> (see page 1224)	:WAVeform:VIEW? (see page 1224)	<view> ::= {MAIN}
n/a	:WAVeform:XINCrement? (see page 1225)	<return_value> ::= x-increment in the current preamble in NR3 format
n/a	:WAVeform:XORigin? (see page 1226)	<return_value> ::= x-origin value in the current preamble in NR3 format
n/a	:WAVeform:XREFerence? (see page 1227)	<return_value> ::= 0 (x-reference value in the current preamble in NR1 format)
n/a	:WAVeform:YINCrement? (see page 1228)	<return_value> ::= y-increment value in the current preamble in NR3 format
n/a	:WAVeform:YORigin? (see page 1229)	<return_value> ::= y-origin in the current preamble in NR3 format
n/a	:WAVeform:YREFerence? (see page 1230)	<return_value> ::= y-reference value in the current preamble in NR1 format

Table 71 :WGEN<w> Commands Summary

Command	Query	Options and Query Returns
:WGEN<w>:ARbitrary:BYTeorder <order> (see page 1235)	:WGEN<w>:ARbitrary:BYTeorder? (see page 1235)	<order> ::= {MSBFirst LSBFirst} <w> ::= 1 or 2 in NR1 format
:WGEN<w>:ARbitrary:DATA {<binary> <value>, <value> ...} (see page 1236)	n/a	<binary> ::= floating point values between -1.0 to +1.0 in IEEE 488.2 binary block format <value> ::= floating point values between -1.0 to +1.0 in comma-separated format <w> ::= 1 or 2 in NR1 format
n/a	:WGEN<w>:ARbitrary:DATA:ATTRibute:POINTs? (see page 1237)	<points> ::= number of points in NR1 format <w> ::= 1 or 2 in NR1 format
:WGEN<w>:ARbitrary:DATA:CLear (see page 1238)	n/a	<w> ::= 1 or 2 in NR1 format
:WGEN<w>:ARbitrary:DATA:DAC {<binary> <value>, <value> ...} (see page 1239)	n/a	<binary> ::= decimal 16-bit integer values between -512 to +511 in IEEE 488.2 binary block format <value> ::= decimal integer values between -512 to +511 in comma-separated NR1 format <w> ::= 1 or 2 in NR1 format
:WGEN<w>:ARbitrary:INTerpolate {{0 OFF} {1 ON}} (see page 1240)	:WGEN<w>:ARbitrary:INTerpolate? (see page 1240)	{0 1} <w> ::= 1 or 2 in NR1 format
:WGEN<w>:ARbitrary:STORe <source> (see page 1241)	n/a	<source> ::= {CHANnel<n> WMEMory<r> FUNction<m> FFT MATH<m>} <n> ::= 1 to (# analog channels) in NR1 format <r> ::= 1 to (# ref waveforms) in NR1 format <m> ::= 1 to (# math functions) in NR1 format <w> ::= 1 or 2 in NR1 format
:WGEN<w>:FREquency <frequency> (see page 1242)	:WGEN<w>:FREquency? (see page 1242)	<frequency> ::= frequency in Hz in NR3 format <w> ::= 1 or 2 in NR1 format

Table 71 :WGEN<w> Commands Summary (continued)

Command	Query	Options and Query Returns
:WGEN<w>:FUNctIon <signal> (see page 1243)	:WGEN<w>:FUNctIon? (see page 1246)	<signal> ::= {SINusoid SQUare RAMP PULSe NOISe DC SINC EXPRise EXPFall CARDiac GAUSSian ARBitary} <w> ::= 1 or 2 in NR1 format
:WGEN<w>:FUNctIon:PUL Se:WIDTh <width> (see page 1247)	:WGEN<w>:FUNctIon:PUL Se:WIDTh? (see page 1247)	<width> ::= pulse width in seconds in NR3 format <w> ::= 1 or 2 in NR1 format
:WGEN<w>:FUNctIon:RAM P:SYMMetry <percent> (see page 1248)	:WGEN<w>:FUNctIon:RAM P:SYMMetry? (see page 1248)	<percent> ::= symmetry percentage from 0% to 100% in NR1 format <w> ::= 1 or 2 in NR1 format
:WGEN<w>:FUNctIon:SQU are:DCYcle <percent> (see page 1249)	:WGEN<w>:FUNctIon:SQU are:DCYcle? (see page 1249)	<percent> ::= duty cycle percentage from 20% to 80% in NR1 format <w> ::= 1 or 2 in NR1 format
:WGEN<w>:MODulation:A M:DEPTh <percent> (see page 1250)	:WGEN<w>:MODulation:A M:DEPTh? (see page 1250)	<percent> ::= AM depth percentage from 0% to 100% in NR1 format <w> ::= 1 in NR1 format
:WGEN<w>:MODulation:A M:FREQuency <frequency> (see page 1251)	:WGEN<w>:MODulation:A M:FREQuency? (see page 1251)	<frequency> ::= modulating waveform frequency in Hz in NR3 format <w> ::= 1 in NR1 format
:WGEN<w>:MODulation:F M:DEViatiOn <frequency> (see page 1252)	:WGEN<w>:MODulation:F M:DEViatiOn? (see page 1252)	<frequency> ::= frequency deviation in Hz in NR3 format <w> ::= 1 in NR1 format
:WGEN<w>:MODulation:F M:FREQuency <frequency> (see page 1253)	:WGEN<w>:MODulation:F M:FREQuency? (see page 1253)	<frequency> ::= modulating waveform frequency in Hz in NR3 format <w> ::= 1 in NR1 format
:WGEN<w>:MODulation:F SKey:FREQuency <percent> (see page 1254)	:WGEN<w>:MODulation:F SKey:FREQuency? (see page 1254)	<frequency> ::= hop frequency in Hz in NR3 format <w> ::= 1 in NR1 format
:WGEN<w>:MODulation:F SKey:RATE <rate> (see page 1255)	:WGEN<w>:MODulation:F SKey:RATE? (see page 1255)	<rate> ::= FSK modulation rate in Hz in NR3 format <w> ::= 1 in NR1 format
:WGEN<w>:MODulation:F UNctIon <shape> (see page 1256)	:WGEN<w>:MODulation:F UNctIon? (see page 1256)	<shape> ::= {SINusoid SQUare RAMP} <w> ::= 1 in NR1 format

Table 71 :WGEN<w> Commands Summary (continued)

Command	Query	Options and Query Returns
:WGEN<w>:MODulation:F UNction:RAMP:SYMMetry <percent> (see page 1257)	:WGEN<w>:MODulation:F UNction:RAMP:SYMMetry ? (see page 1257)	<percent> ::= symmetry percentage from 0% to 100% in NR1 format <w> ::= 1 in NR1 format
:WGEN<w>:MODulation:N OISe <percent> (see page 1258)	:WGEN<w>:MODulation:N OISe? (see page 1258)	<percent> ::= 0 to 100 <w> ::= 1 or 2 in NR1 format
:WGEN<w>:MODulation:S TATE {{0 OFF} {1 ON}} (see page 1259)	:WGEN<w>:MODulation:S TATE? (see page 1259)	{0 1} <w> ::= 1 in NR1 format
:WGEN<w>:MODulation:T YPE <type> (see page 1260)	:WGEN<w>:MODulation:T YPE? (see page 1260)	<type> ::= {AM FM FSK} <w> ::= 1 in NR1 format
:WGEN<w>:OUTPut {{0 OFF} {1 ON}} (see page 1262)	:WGEN<w>:OUTPut? (see page 1262)	{0 1} <w> ::= 1 or 2 in NR1 format
:WGEN<w>:OUTPut:LOAD <impedance> (see page 1263)	:WGEN<w>:OUTPut:LOAD? (see page 1263)	<impedance> ::= {ONEMeg FIFTy} <w> ::= 1 or 2 in NR1 format
:WGEN<w>:OUTPut:MODE <mode> (see page 1264)	:WGEN<w>:OUTPut:MODE? (see page 1264)	<mode> ::= {NORMal SINGLe}
:WGEN<w>:OUTPut:POLar ity <polarity> (see page 1265)	:WGEN<w>:OUTPut:POLar ity? (see page 1265)	<polarity> ::= {NORMal INVerted} <w> ::= 1 or 2 in NR1 format
:WGEN<w>:OUTPut:SINGl e (see page 1266)	n/a	n/a
:WGEN<w>:PERiod <period> (see page 1267)	:WGEN<w>:PERiod? (see page 1267)	<period> ::= period in seconds in NR3 format <w> ::= 1 or 2 in NR1 format
:WGEN<w>:RST (see page 1268)	n/a	<w> ::= 1 or 2 in NR1 format
:WGEN<w>:VOLTage <amplitude> (see page 1269)	:WGEN<w>:VOLTage? (see page 1269)	<amplitude> ::= amplitude in volts in NR3 format <w> ::= 1 or 2 in NR1 format
:WGEN<w>:VOLTage:HIGH <high> (see page 1270)	:WGEN<w>:VOLTage:HIGH ? (see page 1270)	<high> ::= high-level voltage in volts, in NR3 format <w> ::= 1 or 2 in NR1 format

Table 71 :WGEN<w> Commands Summary (continued)

Command	Query	Options and Query Returns
:WGEN<w>:VOLTage:LOW <low> (see page 1271)	:WGEN<w>:VOLTage:LOW? (see page 1271)	<low> ::= low-level voltage in volts, in NR3 format <w> ::= 1 or 2 in NR1 format
:WGEN<w>:VOLTage:OFFSet <offset> (see page 1272)	:WGEN<w>:VOLTage:OFFSet? (see page 1272)	<offset> ::= offset in volts in NR3 format <w> ::= 1 or 2 in NR1 format

Table 72 :WMEMory<r> Commands Summary

Command	Query	Options and Query Returns
:WMEMory<r>:CLear (see page 1275)	n/a	<r> ::= 1 to (# ref waveforms) in NR1 format
:WMEMory<r>:DISPlay {0 OFF} {1 ON} (see page 1276)	:WMEMory<r>:DISPlay? (see page 1276)	<r> ::= 1 to (# ref waveforms) in NR1 format {0 1}
:WMEMory<r>:LABel <string> (see page 1277)	:WMEMory<r>:LABel? (see page 1277)	<r> ::= 1 to (# ref waveforms) in NR1 format <string> ::= any series of 10 or less ASCII characters enclosed in quotation marks
:WMEMory<r>:SAVE <source> (see page 1278)	n/a	<r> ::= 1 to (# ref waveforms) in NR1 format <source> ::= {CHANnel<n> FUNCTION<m> MATH<m>} <n> ::= 1 to (# analog channels) in NR1 format <m> ::= 1 to (# math functions) in NR1 format NOTE: Math functions whose x-axis is not frequency can be saved as reference waveforms.
:WMEMory<r>:SKEW <skew> (see page 1279)	:WMEMory<r>:SKEW? (see page 1279)	<r> ::= 1 to (# ref waveforms) in NR1 format <skew> ::= time in seconds in NR3 format
:WMEMory<r>:YOFFset <offset>[suffix] (see page 1280)	:WMEMory<r>:YOFFset? (see page 1280)	<r> ::= 1 to (# ref waveforms) in NR1 format <offset> ::= vertical offset value in NR3 format [suffix] ::= {V mV}

Table 72 :WMemory<r> Commands Summary (continued)

Command	Query	Options and Query Returns
:WMemory<r>:YRANge <range>[suffix] (see page 1281)	:WMemory<r>:YRANge? (see page 1281)	<r> ::= 1 to (# ref waveforms) in NR1 format <range> ::= vertical full-scale range value in NR3 format [suffix] ::= {V mV}
:WMemory<r>:YSCale <scale>[suffix] (see page 1282)	:WMemory<r>:YSCale? (see page 1282)	<r> ::= 1 to (# ref waveforms) in NR1 format <scale> ::= vertical units per division value in NR3 format [suffix] ::= {V mV}

Syntax Elements

- **"Number Format"** on page 183
- **"<NL> (Line Terminator)"** on page 183
- **"[] (Optional Syntax Terms)"** on page 183
- **"{ } (Braces)"** on page 183
- **"::= (Defined As)"** on page 183
- **"< > (Angle Brackets)"** on page 184
- **"... (Ellipsis)"** on page 184
- **"n,...,p (Value Ranges)"** on page 184
- **"d (Digits)"** on page 184
- **"Quoted ASCII String"** on page 184
- **"Definite-Length Block Response Data"** on page 184

Number Format

NR1 specifies integer data.

NR3 specifies exponential data in floating point format (for example, -1.0E-3).

<NL> (Line Terminator)

<NL> = new line or linefeed (ASCII decimal 10).

The line terminator, or a leading colon, will send the parser to the "root" of the command tree.

[] (Optional Syntax Terms)

Items enclosed in square brackets, [], are optional.

{ } (Braces)

When several items are enclosed by braces, { }, only one of these elements may be selected. Vertical line (|) indicates "or". For example, {ON | OFF} indicates that only ON or OFF may be selected, not both.

::= (Defined As)

::= means "defined as".

For example, <A> ::= indicates that <A> can be replaced by in any statement containing <A>.

< > (Angle Brackets)

< > Angle brackets enclose words or characters that symbolize a program code parameter or an interface command.

... (Ellipsis)

... An ellipsis (trailing dots) indicates that the preceding element may be repeated one or more times.

n,...,p (Value Ranges)

n,...,p ::= all integers between n and p inclusive.

d (Digits)

d ::= A single ASCII numeric character 0 - 9.

Quoted ASCII String

A quoted ASCII string is a string delimited by either double quotes (") or single quotes ('). Some command parameters require a quoted ASCII string. For example, when using the Keysight VISA COM library in Visual Basic, the command:

```
myScope.WriteString ":CHANNEL1:LABEL 'One' "
```

has a quoted ASCII string of:

```
'One'
```

In order to read quoted ASCII strings from query return values, some programming languages require special handling or syntax.

Definite-Length Block Response Data

Definite-length block response data allows any type of device-dependent data to be transmitted over the system interface as a series of 8-bit binary data bytes. This is particularly useful for sending large quantities of data or 8-bit extended ASCII codes. This syntax is a pound sign (#) followed by a non-zero digit representing the number of digits in the decimal integer. After the non-zero digit is the decimal integer that states the number of 8-bit data bytes being sent. This is followed by the actual data.

For example, for transmitting 1000 bytes of data, the syntax would be

```
#800001000<1000 bytes of data> <NL>
```

8 is the number of digits that follow

00001000 is the number of bytes to be transmitted

<1000 bytes of data> is the actual data

5 Common (*) Commands

Commands defined by IEEE 488.2 standard that are common to all instruments. See "[Introduction to Common \(*\) Commands](#)" on page 190.

Table 73 Common (*) Commands Summary

Command	Query	Options and Query Returns
*CLS (see page 191)	n/a	n/a
*ESE <mask> (see page 192)	*ESE? (see page 193)	<mask> ::= 0 to 255; an integer in NR1 format: Bit Weight Name Enables ---- 7 128 PON Power On 6 64 URQ User Request 5 32 CME Command Error 4 16 EXE Execution Error 3 8 DDE Dev. Dependent Error 2 4 QYE Query Error 1 2 RQL Request Control 0 1 OPC Operation Complete
n/a	*ESR? (see page 194)	<status> ::= 0 to 255; an integer in NR1 format
n/a	*IDN? (see page 194)	KEYSIGHT TECHNOLOGIES,<model>,<serial number>,X.XX.XX <model> ::= the model number of the instrument <serial number> ::= the serial number of the instrument <X.XX.XX> ::= the software revision of the instrument
n/a	*LRN? (see page 197)	<learn_string> ::= current instrument setup as a block of data in IEEE 488.2 # format
*OPC (see page 198)	*OPC? (see page 198)	ASCII "1" is placed in the output queue when all pending device operations have completed.

Table 73 Common (*) Commands Summary (continued)

Command	Query	Options and Query Returns
n/a	*OPT? (see page 199)	<pre> <return_value> ::= 0,0,<license info> <license info> ::= <All field>, <reserved>, <MSO>, <Xilinx FPGA Probe>, <Memory>, <Low Speed Serial>, <Automotive Serial>, <reserved>, <FlexRay Serial>? <Power Measurements>, <RS-232/UART Serial>, <reserved>, <Mask Test>, <reserved>, <Bandwidth>, <reserved>, <reserved>, <reserved>, <I2S Serial>, <reserved>, <Educator's Kit>, <Waveform Generator>, <MIL-1553/ARINC 429 Serial>, <Extended Video>, <reserved>, <reserved>, <reserved>, <reserved>, <Digital Voltmeter>, <Spectrum Visualizer>, <reserved>, <reserved>, <USB 2.0 Low/Full Speed>, <USB 2.0 High Speed> <All field> ::= {0 All} <reserved> ::= 0 <MSO> ::= {0 MSO} <Xilinx FPGA Probe> ::= {0 FPGAX} <Memory> ::= {0 MEMUP} <Low Speed Serial> ::= {0 EMBD} <Automotive Serial> ::= {0 AUTO} <FlexRay Serial> ::= {0 FLEX} <Power Measurements> ::= {0 PWR} <RS-232/UART Serial> ::= {0 COMP} <Mask Test> ::= {0 MASK} <Bandwidth> ::= {0 BW20 BW50} <I2S Serial> ::= {0 AUDIO} <Educator's Kit> ::= {0 EDK} <Waveform Generator> ::= {0 WAVEGEN} <MIL-1553/ARINC 429 Serial> ::= {0 AERO} <Extended Video> ::= {0 VID} <Digital Voltmeter> ::= {0 DVM} <Spectrum Visualizer> ::= {0 ASV} <USB 2.0 Low/Full Speed> ::= {0 USF} <USB 2.0 High Speed> ::= {0 USH} </pre>

Table 73 Common (*) Commands Summary (continued)

Command	Query	Options and Query Returns
*RCL <value> (see page 201)	n/a	<value> ::= {0 1 4 5 6 7 8 9}
*RST (see page 202)	n/a	See *RST (Reset) (see page 202)
*SAV <value> (see page 205)	n/a	<value> ::= {0 1 4 5 6 7 8 9}
*SRE <mask> (see page 206)	*SRE? (see page 207)	<p><mask> ::= sum of all bits that are set, 0 to 255; an integer in NR1 format. <mask> ::= following values:</p> <pre> Bit Weight Name Enables ----- 7 128 OPER Operation Status Reg 6 64 ---- (Not used.) 5 32 ESB Event Status Bit 4 16 MAV Message Available 3 8 ---- (Not used.) 2 4 MSG Message 1 2 USR User 0 1 TRG Trigger </pre>
n/a	*STB? (see page 208)	<p><value> ::= 0 to 255; an integer in NR1 format, as shown in the following:</p> <pre> Bit Weight Name "1" Indicates ----- 7 128 OPER Operation status condition occurred. 6 64 RQS/ Instrument is MSS requesting service. 5 32 ESB Enabled event status condition occurred. 4 16 MAV Message available. 3 8 ---- (Not used.) 2 4 MSG Message displayed. 1 2 USR User event condition occurred. 0 1 TRG A trigger occurred. </pre>
*TRG (see page 210)	n/a	n/a
n/a	*TST? (see page 211)	<result> ::= 0 or non-zero value; an integer in NR1 format
*WAI (see page 212)	n/a	n/a

**Introduction to
Common (*)
Commands**

The common commands are defined by the IEEE 488.2 standard. They are implemented by all instruments that comply with the IEEE 488.2 standard. They provide some of the basic instrument functions, such as instrument identification and reset, reading the instrument setup, and determining how status is read and cleared.

Common commands can be received and processed by the instrument whether they are sent over the interface as separate program messages or within other program messages. If an instrument subsystem has been selected and a common command is received by the instrument, the instrument remains in the selected subsystem. For example, if the program message ":ACQUIRE:TYPE AVERAGE; *CLS; COUNT 256" is received by the instrument, the instrument sets the acquire type, then clears the status information and sets the average count.

In contrast, if a root level command or some other subsystem command is within the program message, you must re-enter the original subsystem after the command. For example, the program message ":ACQUIRE:TYPE AVERAGE; :AUTOSCALE; :ACQUIRE:COUNT 256" sets the acquire type, completes the autoscale, then sets the acquire count. In this example, :ACQUIRE must be sent again after the :AUTOSCALE command in order to re-enter the ACQUIRE subsystem and set the count.

NOTE

Each of the status registers has an enable (mask) register. By setting the bits in the enable register, you can select the status information you want to use.

*CLS (Clear Status)

C (see [page 1384](#))

Command Syntax

*CLS

The *CLS common command clears the status data structures, the device-defined error queue, and the Request-for-OPC flag.

NOTE

If the *CLS command immediately follows a program message terminator, the output queue and the MAV (message available) bit are cleared.

- See Also
- ["Introduction to Common \(*\) Commands"](#) on page 190
 - ["*STB \(Read Status Byte\)"](#) on page 208
 - ["*ESE \(Standard Event Status Enable\)"](#) on page 192
 - ["*ESR \(Standard Event Status Register\)"](#) on page 194
 - ["*SRE \(Service Request Enable\)"](#) on page 206
 - ["::SYSTem:ERRor"](#) on page 1065

*ESE (Standard Event Status Enable)

C (see [page 1384](#))

Command Syntax *ESE <mask_argument>

<mask_argument> ::= integer from 0 to 255

The *ESE common command sets the bits in the Standard Event Status Enable Register. The Standard Event Status Enable Register contains a mask value for the bits to be enabled in the Standard Event Status Register. A "1" in the Standard Event Status Enable Register enables the corresponding bit in the Standard Event Status Register. A zero disables the bit.

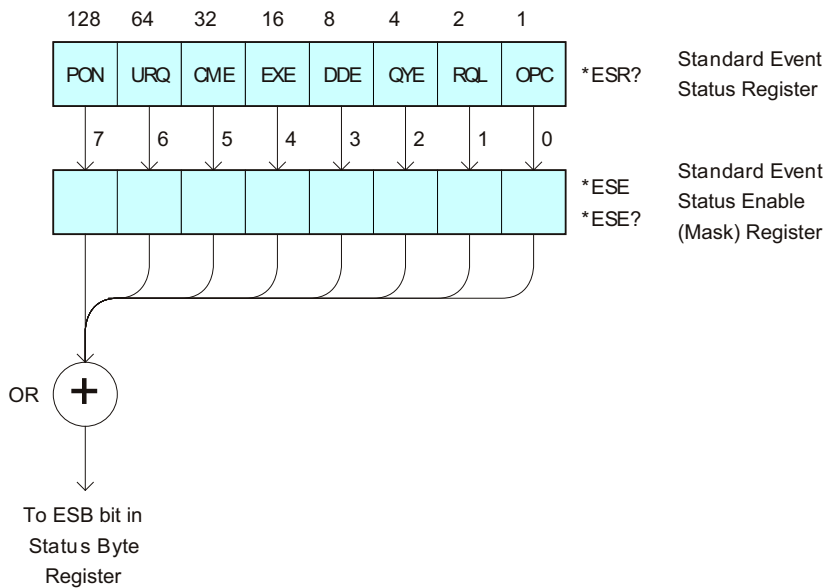

Table 74 Standard Event Status Enable (ESE)

Bit	Name	Description	When Set (1 = High = True), Enables:
7	PON	Power On	Event when an OFF to ON transition occurs.
6	URQ	User Request	Event when a front-panel key is pressed.
5	CME	Command Error	Event when a command error is detected.
4	EXE	Execution Error	Event when an execution error is detected.
3	DDE	Device Dependent Error	Event when a device-dependent error is detected.
2	QYE	Query Error	Event when a query error is detected.
1	RQL	Request Control	Event when the device is requesting control. (Not used.)
0	OPC	Operation Complete	Event when an operation is complete.

Query Syntax *ESE?

The *ESE? query returns the current contents of the Standard Event Status Enable Register.

Return Format <mask_argument><NL>

<mask_argument> ::= 0,..,255; an integer in NR1 format.

- See Also**
- ["Introduction to Common \(*\) Commands"](#) on page 190
 - ["*ESR \(Standard Event Status Register\)"](#) on page 194
 - ["*OPC \(Operation Complete\)"](#) on page 198
 - ["*CLS \(Clear Status\)"](#) on page 191

*ESR (Standard Event Status Register)

C (see [page 1384](#))

Query Syntax *ESR?

The *ESR? query returns the contents of the Standard Event Status Register. When you read the Event Status Register, the value returned is the total bit weights of all of the bits that are high at the time you read the byte. Reading the register clears the Event Status Register.

The following table shows bit weight, name, and condition for each bit.

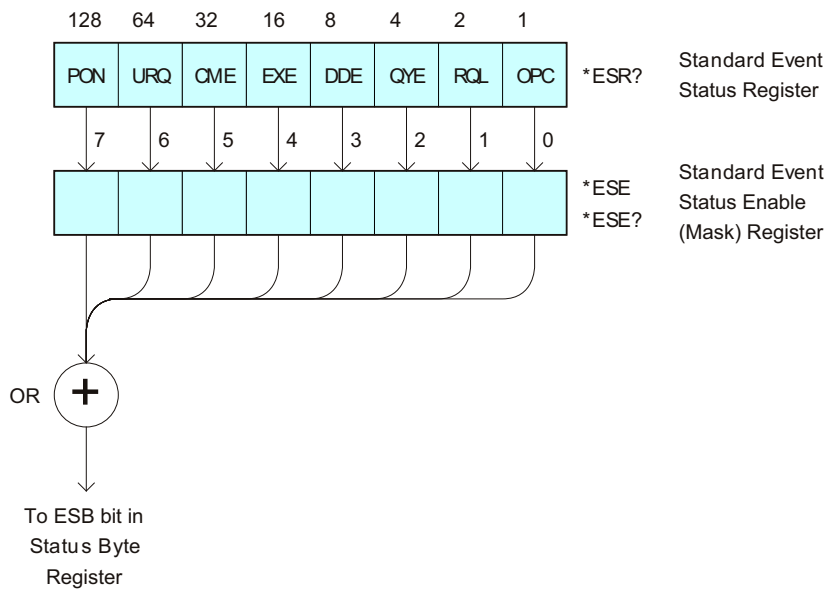

Table 75 Standard Event Status Register (ESR)

Bit	Name	Description	When Set (1 = High = True), Indicates:
7	PON	Power On	An OFF to ON transition has occurred.
6	URQ	User Request	A front-panel key has been pressed.
5	CME	Command Error	A command error has been detected.
4	EXE	Execution Error	An execution error has been detected.
3	DDE	Device Dependent Error	A device-dependent error has been detected.
2	QYE	Query Error	A query error has been detected.
1	RQL	Request Control	The device is requesting control. (Not used.)
0	OPC	Operation Complete	Operation is complete.

Return Format <status><NL>
<status> ::= 0,..,255; an integer in NR1 format.

NOTE

Reading the Standard Event Status Register clears it. High or 1 indicates the bit is true.

- See Also**
- ["Introduction to Common \(*\) Commands"](#) on page 190
 - ["*ESE \(Standard Event Status Enable\)"](#) on page 192
 - ["*OPC \(Operation Complete\)"](#) on page 198
 - ["*CLS \(Clear Status\)"](#) on page 191
 - [":SYSTem:ERRor"](#) on page 1065

*IDN (Identification Number)

C (see [page 1384](#))

Query Syntax *IDN?

The *IDN? query identifies the instrument type and software version.

Return Format <manufacturer_string>, <model>, <serial_number>, X.XX.XX <NL>

<manufacturer_string> ::= KEYSIGHT TECHNOLOGIES

<model> ::= the model number of the instrument

<serial_number> ::= the serial number of the instrument

X.XX.XX ::= the software revision of the instrument

- See Also**
- ["Introduction to Common \(*\) Commands"](#) on page 190
 - ["*OPT \(Option Identification\)"](#) on page 199
 - ["::SYSTem:PERSONa\[:MANUFACTURER\]"](#) on page 1067
 - ["::SYSTem:PERSONa\[:MANUFACTURER\]:DEFAULT"](#) on page 1068

*LRN (Learn Device Setup)

C (see [page 1384](#))

Query Syntax

*LRN?

The *LRN? query result contains the current state of the instrument. This query is similar to the :SYSTem:SETup? (see [page 1080](#)) query, except that it contains ":SYST:SET " before the binary block data. The query result is a valid command that can be used to restore instrument settings at a later time.

Return Format

<learn_string><NL>

<learn_string> ::= :SYST:SET <setup_data>

<setup_data> ::= binary block data in IEEE 488.2 # format

<learn string> specifies the current instrument setup. The block size is subject to change with different firmware revisions.

NOTE

The *LRN? query return format has changed from previous Keysight oscilloscopes to match the IEEE 488.2 specification which says that the query result must contain ":SYST:SET " before the binary block data.

-
- See Also
- ["Introduction to Common \(*\) Commands"](#) on page 190
 - ["*RCL \(Recall\)"](#) on page 201
 - ["*SAV \(Save\)"](#) on page 205
 - [":SYSTem:SETup"](#) on page 1080

*OPC (Operation Complete)

C (see [page 1384](#))

Command Syntax *OPC

The *OPC command sets the operation complete bit in the Standard Event Status Register when all pending device operations have finished.

Query Syntax *OPC?

The *OPC? query places an ASCII "1" in the output queue when all pending device operations have completed. The interface hangs until this query returns.

Return Format <complete><NL>

<complete> ::= 1

- See Also**
- ["Introduction to Common \(*\) Commands"](#) on page 190
 - ["*ESE \(Standard Event Status Enable\)"](#) on page 192
 - ["*ESR \(Standard Event Status Register\)"](#) on page 194
 - ["*CLS \(Clear Status\)"](#) on page 191

*OPT (Option Identification)

C (see [page 1384](#))

Query Syntax *OPT?

The *OPT? query reports the options installed in the instrument. This query returns a string that identifies the module and its software revision level.

Return Format 0,0,<license info>

```

<license info> ::= <All field>, <reserved>, <MSO>, <reserved>,
  <Memory>, <Low Speed Serial>, <Automotive Serial>, <FlexRay Serial>,
  <Power Measurements>, <RS-232/UART Serial>, <Segmented Memory>,
  <Mask Test>, <reserved>, <Bandwidth>, <reserved>, <reserved>,
  <reserved>, <I2S Serial>, <reserved>, <Educator's Kit>,
  <Waveform Generator>, <MIL-1553/ARINC 429 Serial>, <Extended Video>,
  <Advanced Math>, <reserved>, <reserved>, <reserved>, <reserved>,
  <Digital Voltmeter/Counter>, <reserved>, <reserved>, <reserved>,
  <reserved>, <reserved>, <Remote Command Logging>, <reserved>,
  <SENT Serial>, <CAN FD Serial>, <CXPI Serial>, <NFC Trigger>

```

```
<All field> ::= {0 | All}
```

```
<reserved> ::= 0
```

```
<MSO> ::= {0 | MSO}
```

```
<Memory> ::= {0 | memMax}
```

```
<Low Speed Serial> ::= {0 | EMBD}
```

```
<Automotive Serial> ::= {0 | AUTO}
```

```
<FlexRay Serial> ::= {0 | FLEX}
```

```
<Power Measurements> ::= {0 | PWR}
```

```
<RS-232/UART Serial> ::= {0 | COMP}
```

```
<Segmented Memory> ::= {0 | SGM}
```

```
<Mask Test> ::= {0 | MASK}
```

```
<Bandwidth> ::= {0 | BW50}
```

```
<I2S Serial> ::= {0 | AUDIO}
```

```
<Educator's Kit> ::= {0 | EDK}
```

```
<Waveform Generator> ::= {0 | WAVEGEN}
```

```
<MIL-1553/ARINC 429 Serial> ::= {0 | AERO}
```

```
<Extended Video> ::= {0 | VID}
```

```
<Advanced Math> ::= {0 | ADVMATH}
```

```
<Digital Voltmeter/Counter>> ::= {0 | DVMCTR}
```

```
<Remote Command Logging> ::= {0 | RML}
```

5 Common (*) Commands

<SENT Serial> ::= {0 | SENSOR}

<CAN FD Serial> ::= {0 | CANFD}

<CXPI Serial> ::= {0 | CXPI}

<NFC Trigger> ::= {0 | NFC}

The <MSO> field indicates whether the unit is a mixed-signal oscilloscope.

The *OPT? query returns the following:

Module	Module Id
No modules attached	0,0,0,0,0,0,MEMUP,0,0,0,0,0,SGM,0,0,0,0,0,0,0,0,0,0,0,0,0,0,0,0,0,0,ADVMATH,0,0,0,0,0,0,0,0,0,0,0,0,0,0,0,0

- See Also
- ["Introduction to Common \(*\) Commands"](#) on page 190
 - ["*IDN \(Identification Number\)"](#) on page 196

*RCL (Recall)

C (see [page 1384](#))

Command Syntax *RCL <value>

<value> ::= {0 | 1 | 2 | 3 | 4 | 5 | 6 | 7 | 8 | 9}

The *RCL command restores the state of the instrument from the specified save/recall register.

- See Also**
- ["Introduction to Common \(*\) Commands"](#) on page 190
 - ["*SAV \(Save\)"](#) on page 205

*RST (Reset)

C (see [page 1384](#))

Command Syntax *RST

The *RST command places the instrument in a known state. This is the same as pressing **[Save/Recall] > Default/Erase > Factory Default** on the front panel.

When you perform a factory default setup, there are no user settings that remain unchanged. To perform the equivalent of the front panel's **[Default Setup]** key, where some user settings (like preferences) remain unchanged, use the :SYSTem:PRESet command.

Reset conditions are:

Acquire Menu	
Mode	Normal
Averaging	Off
# Averages	8

Analog Channel Menu	
Channel 1	On
Channel 2	Off
Volts/division	5.00 V
Offset	0.00
Coupling	DC
Probe attenuation	AutoProbe (if AutoProbe is connected), otherwise 1.0:1
Vernier	Off
Invert	Off
BW limit	Off
Impedance	1 M Ohm
Units	Volts
Skew	0

Cursor Menu	
Source	Channel 1

Digital Channel Menu (MSO models only)	
Channel 0 - 15	Off
Labels	Off
Threshold	TTL (1.4 V)

Display Menu	
Persistence	Off
Grid	20%

Quick Meas Menu	
Source	Channel 1

Run Control	
	Scope is running

Time Base Menu	
Main time/division	100 us
Main time base delay	0.00 s
Delay time/division	500 ns
Delay time base delay	0.00 s
Reference	center
Mode	main
Vernier	Off

Trigger Menu	
Type	Edge
Mode	Auto
Coupling	dc
Source	Channel 1
Level	0.0 V
Slope	Positive

Trigger Menu	
HF Reject and noise reject	Off
Holdoff	40 ns
External probe attenuation	10:1
External Units	Volts
External Impedance	1 M Ohm (cannot be changed)

- See Also
- ["Introduction to Common \(*\) Commands"](#) on page 190
 - [":SYSTem:PRESet"](#) on page 1069

Example Code

```
' RESET - This command puts the oscilloscope into a known state.
' This statement is very important for programs to work as expected.
' Most of the following initialization commands are initialized by
' *RST. It is not necessary to reinitialize them unless the default
' setting is not suitable for your application.
myScope.WriteString "*RST" ' Reset the oscilloscope to the defaults.
```

See complete example programs at: [Chapter 42](#), "Programming Examples," starting on page 1393

*SAV (Save)

C (see [page 1384](#))

Command Syntax *SAV <value>

<value> ::= {0 | 1 | 2 | 3 | 4 | 5 | 6 | 7 | 8 | 9}

The *SAV command stores the current state of the instrument in a save register. The data parameter specifies the register where the data will be saved.

- See Also**
- ["Introduction to Common \(*\) Commands"](#) on page 190
 - ["*RCL \(Recall\)"](#) on page 201

*SRE (Service Request Enable)

C (see [page 1384](#))

Command Syntax *SRE <mask>

<mask> ::= integer with values defined in the following table.

The *SRE command sets the bits in the Service Request Enable Register. The Service Request Enable Register contains a mask value for the bits to be enabled in the Status Byte Register. A one in the Service Request Enable Register enables the corresponding bit in the Status Byte Register. A zero disables the bit.

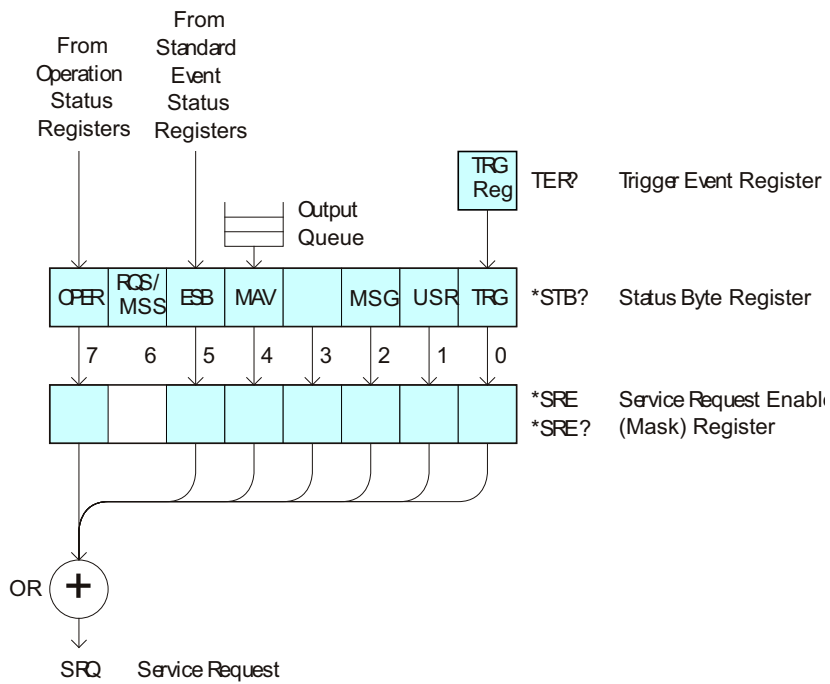

Table 76 Service Request Enable Register (SRE)

Bit	Name	Description	When Set (1 = High = True), Enables:
7	OPER	Operation Status Register	Interrupts when enabled conditions in the Operation Status Register (OPER) occur.
6	---	---	(Not used.)
5	ESB	Event Status Bit	Interrupts when enabled conditions in the Standard Event Status Register (ESR) occur.
4	MAV	Message Available	Interrupts when messages are in the Output Queue.
3	---	---	(Not used.)
2	MSG	Message	Interrupts when an advisory has been displayed on the oscilloscope.
1	USR	User Event	Interrupts when enabled user event conditions occur.
0	TRG	Trigger	Interrupts when a trigger occurs.

Query Syntax *SRE?

The *SRE? query returns the current value of the Service Request Enable Register.

Return Format <mask><NL>

<mask> ::= sum of all bits that are set, 0,...,255;
an integer in NR1 format

- See Also**
- ["Introduction to Common \(*\) Commands"](#) on page 190
 - ["*STB \(Read Status Byte\)"](#) on page 208
 - ["*CLS \(Clear Status\)"](#) on page 191

*STB (Read Status Byte)

C (see [page 1384](#))

Query Syntax *STB?

The *STB? query returns the current value of the instrument's status byte. The MSS (Master Summary Status) bit is reported on bit 6 instead of the RQS (request service) bit. The MSS indicates whether or not the device has at least one reason for requesting service.

Return Format <value><NL>

<value> ::= 0,...,255; an integer in NR1 format

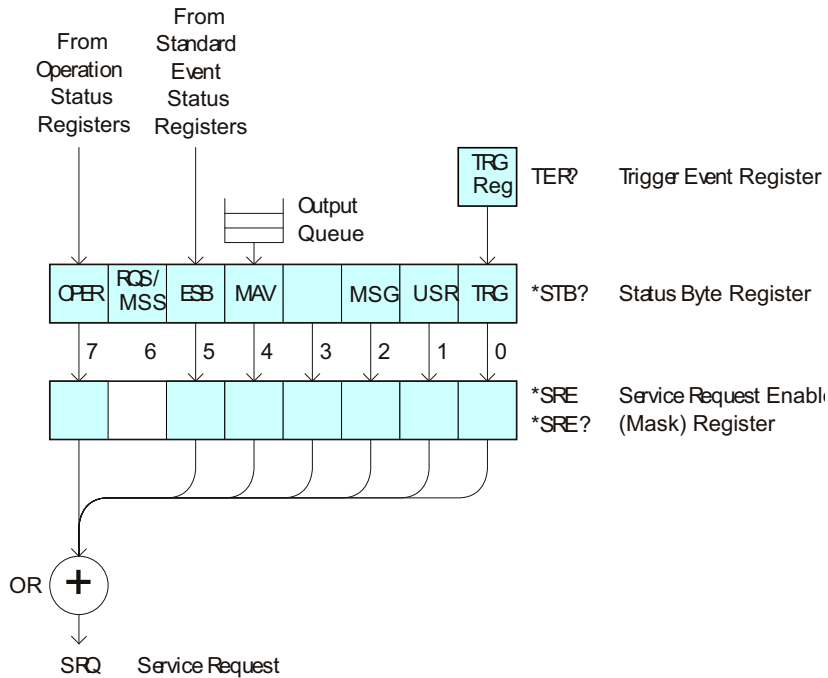

Table 77 Status Byte Register (STB)

Bit	Name	Description	When Set (1 = High = True), Indicates:
7	OPER	Operation Status Register	An enabled condition in the Operation Status Register (OPER) has occurred.
6	RQS	Request Service	When polled, that the device is requesting service.
	MSS	Master Summary Status	When read (by *STB?), whether the device has a reason for requesting service.
5	ESB	Event Status Bit	An enabled condition in the Standard Event Status Register (ESR) has occurred.
4	MAV	Message Available	There are messages in the Output Queue.
3	---	---	(Not used, always 0.)
2	MSG	Message	An advisory has been displayed on the oscilloscope.
1	USR	User Event	An enabled user event condition has occurred.
0	TRG	Trigger	A trigger has occurred.

NOTE

To read the instrument's status byte with RQS reported on bit 6, use the interface Serial Poll.

- See Also
- ["Introduction to Common \(*\) Commands"](#) on page 190
 - ["*SRE \(Service Request Enable\)"](#) on page 206

*TRG (Trigger)

C (see [page 1384](#))

Command Syntax

*TRG

The *TRG command has the same effect as the :DIGitize command with no parameters.

- See Also**
- ["Introduction to Common \(*\) Commands"](#) on page 190
 - [":DIGitize"](#) on page 225
 - [":RUN"](#) on page 246
 - [":STOP"](#) on page 250

*TST (Self Test)

C (see [page 1384](#))

Query Syntax

*TST?

The *TST? query performs a self-test on the instrument. The result of the test is placed in the output queue. A zero indicates the test passed and a non-zero indicates the test failed. If the test fails, refer to the troubleshooting section of the *Service Guide*.

Return Format

<result><NL>

<result> ::= 0 or non-zero value; an integer in NR1 format

See Also • ["Introduction to Common \(*\) Commands"](#) on page 190

*WAI (Wait To Continue)

C (see [page 1384](#))

Command Syntax

*WAI

The *WAI command has no function in the oscilloscope, but is parsed for compatibility with other instruments.

See Also · ["Introduction to Common \(*\) Commands"](#) on page 190

6 Root (:) Commands

Control many of the basic functions of the oscilloscope and reside at the root level of the command tree. See ["Introduction to Root \(:\) Commands"](#) on page 216.

Table 78 Root (:) Commands Summary

Command	Query	Options and Query Returns
:ACTivity (see page 217)	:ACTivity? (see page 217)	<return value> ::= <edges>,<levels> <edges> ::= presence of edges (32-bit integer in NR1 format) <levels> ::= logical highs or lows (32-bit integer in NR1 format)
n/a	:AER? (see page 218)	{0 1}; an integer in NR1 format
:AUToscale [<source>[,...,<source>]] (see page 219)	n/a	<source> ::= CHANNEL<n> for DSO models <source> ::= {CHANNEL<n> DIGital<d> POD1 POD2} for MSO models <source> can be repeated up to 5 times <n> ::= 1 to (# analog channels) in NR1 format <d> ::= 0 to (# digital channels - 1) in NR1 format
:AUToscale:AMODE <value> (see page 221)	:AUToscale:AMODE? (see page 221)	<value> ::= {NORMAL CURRENT}}
:AUToscale:CHANnels <value> (see page 222)	:AUToscale:CHANnels? (see page 222)	<value> ::= {ALL DISPLAYed}}
:AUToscale:FDEBug {{0 OFF} {1 ON}} (see page 223)	:AUToscale:FDEBug? (see page 223)	{0 1}

Table 78 Root (:) Commands Summary (continued)

Command	Query	Options and Query Returns
:BLANK [<source>] (see page 224)	n/a	<source> ::= {CHANnel<n> FUNctIon<m> MATH<m> FFT SBUS{1 2} WMEMory<r>} for DSO models <source> ::= {CHANnel<n> DIGital<d> POD{1 2} BUS{1 2} FUNctIon<m> MATH<m> FFT SBUS{1 2} WMEMory<r>} for MSO models <n> ::= 1 to (# analog channels) in NR1 format <d> ::= 0 to (# digital channels - 1) in NR1 format <m> ::= 1 to (# math functions) in NR1 format <r> ::= 1 to (# ref waveforms) in NR1 format
:DIGitize [<source>[,...,<source >]] (see page 225)	n/a	<source> ::= {CHANnel<n> FUNctIon<m> MATH<m> FFT SBUS{1 2}} for DSO models <source> ::= {CHANnel<n> DIGital<d> POD{1 2} BUS{1 2} FUNctIon<m> MATH<m> FFT SBUS{1 2}} for MSO models <source> can be repeated up to 5 times <n> ::= 1 to (# analog channels) in NR1 format <d> ::= 0 to (# digital channels - 1) in NR1 format <m> ::= 1 to (# math functions) in NR1 format
:HWEenable <n> (see page 227)	:HWEenable? (see page 227)	<n> ::= 16-bit integer in NR1 format
n/a	:HWERegister:CONDiti on? (see page 229)	<n> ::= 16-bit integer in NR1 format
n/a	:HWERegister[:EVENT]? (see page 230)	<n> ::= 16-bit integer in NR1 format
:MTEenable <n> (see page 231)	:MTEenable? (see page 231)	<n> ::= 16-bit integer in NR1 format
n/a	:MTERegister[:EVENT]? (see page 233)	<n> ::= 16-bit integer in NR1 format

Table 78 Root (:) Commands Summary (continued)

Command	Query	Options and Query Returns
:OPEE <n> (see page 235)	:OPEE? (see page 236)	<n> ::= 15-bit integer in NR1 format
n/a	:OPERregister:CONDition? (see page 237)	<n> ::= 15-bit integer in NR1 format
n/a	:OPERRegister[:EVENT]? (see page 239)	<n> ::= 15-bit integer in NR1 format
:OVLenable <mask> (see page 241)	:OVLenable? (see page 242)	<p><mask> ::= 16-bit integer in NR1 format as shown:</p> <pre> Bit Weight Input ----- 10 1024 Ext Trigger Fault 9 512 Channel 4 Fault 8 256 Channel 3 Fault 7 128 Channel 2 Fault 6 64 Channel 1 Fault 4 16 Ext Trigger OVL 3 8 Channel 4 OVL 2 4 Channel 3 OVL 1 2 Channel 2 OVL 0 1 Channel 1 OVL </pre>
n/a	:OVLRegister? (see page 243)	<value> ::= integer in NR1 format. See OVLenable for <value>
:PRINT [<options>] (see page 245)	n/a	<p><options> ::= [<print option>][, ..., <print option>]</p> <p><print option> ::= {COLor GRAYscale PRINter0 BMP8bit BMP PNG NOFactoRs FACToRs}</p> <p><print option> can be repeated up to 5 times.</p>
:RUN (see page 246)	n/a	n/a
n/a	:SERial (see page 247)	<return value> ::= unquoted string containing serial number
:SINGLE (see page 248)	n/a	n/a

Table 78 Root (:) Commands Summary (continued)

Command	Query	Options and Query Returns
n/a	:STATus? <display> (see page 249)	{0 1} <display> ::= {CHANnel<n> DIGital<d> POD{1 2} BUS{1 2} FUNction<m> MATH<m> FFT SBUS{1 2} WMEMory<r>} <n> ::= 1 to (# analog channels) in NR1 format <d> ::= 0 to (# digital channels - 1) in NR1 format <m> ::= 1 to (# math functions) in NR1 format <r> ::= 1 to (# ref waveforms) in NR1 format
:STOP (see page 250)	n/a	n/a
n/a	:TER? (see page 251)	{0 1}
:VIEW <source> (see page 252)	n/a	<source> ::= {CHANnel<n> FUNction<m> MATH<m> FFT SBUS{1 2} WMEMory<r>} for DSO models <source> ::= {CHANnel<n> DIGital<d> POD{1 2} BUS{1 2} FUNction<m> MATH<m> FFT SBUS{1 2} WMEMory<r>} for MSO models <n> ::= 1 to (# analog channels) in NR1 format <d> ::= 0 to (# digital channels - 1) in NR1 format <m> ::= 1 to (# math functions) in NR1 format <r> ::= 1 to (# ref waveforms) in NR1 format

**Introduction to
Root (:)
Commands**

Root level commands control many of the basic operations of the instrument. These commands are always recognized by the parser if they are prefixed with a colon, regardless of current command tree position. After executing a root-level command, the parser is positioned at the root of the command tree.

:ACTivity

N (see [page 1384](#))

Command Syntax :ACTivity

The :ACTivity command clears the cumulative edge variables for the next activity query.

Query Syntax :ACTivity?

The :ACTivity? query returns whether there has been activity (edges) on the digital channels since the last query, and returns the current logic levels.

NOTE

Because the :ACTivity? query returns edge activity since the last :ACTivity? query, you must send this query twice before the edge activity result is valid.

Return Format

<edges>, <levels><NL>

<edges> ::= presence of edges (16-bit integer in NR1 format).

<levels> ::= logical highs or lows (16-bit integer in NR1 format).

bit 0 ::= DIGital 0

bit 15 ::= DIGital 15

NOTE

A bit = 0 (zero) in the <edges> result indicates that no edges were detected on that channel (across the specified threshold voltage) since the last query.

A bit = 1 (one) in the <edges> result indicates that edges have been detected on that channel (across the specified threshold voltage) since the last query.

(The threshold voltage must be set appropriately for the logic levels of the signals being probed.)

- See Also**
- ["Introduction to Root \(:\) Commands"](#) on page 216
 - [":POD<n>:THReshold"](#) on page 619
 - [":DIGital<d>:THReshold"](#) on page 339

:AER (Arm Event Register)**C** (see [page 1384](#))**Query Syntax** :AER?

The AER query reads the Arm Event Register. After the Arm Event Register is read, it is cleared. A "1" indicates the trigger system is in the armed state, ready to accept a trigger.

The Armed Event Register is summarized in the Wait Trig bit of the Operation Status Event Register. A Service Request can be generated when the Wait Trig bit transitions and the appropriate enable bits have been set in the Operation Status Enable Register (OPEE) and the Service Request Enable Register (SRE).

Return Format <value><NL>

<value> ::= {0 | 1}; an integer in NR1 format.

- See Also**
- ["Introduction to Root \(:\) Commands"](#) on page 216
 - [":OPEE \(Operation Status Enable Register\)"](#) on page 235
 - [":OPERRegister:CONDition \(Operation Status Condition Register\)"](#) on page 237
 - [":OPERRegister\[:EVENT\] \(Operation Status Event Register\)"](#) on page 239
 - ["*STB \(Read Status Byte\)"](#) on page 208
 - ["*SRE \(Service Request Enable\)"](#) on page 206

:AUToscale

C (see [page 1384](#))

Command Syntax :AUToscale
 :AUToscale [<source>[,...,<source>]]
 <source> ::= CHANnel<n> for the DSO models
 <source> ::= {DIGital<d> | POD1 | POD2 | CHANnel<n>} for the
 MSO models
 <n> ::= 1 to (# analog channels) in NR1 format
 <d> ::= 0 to (# digital channels - 1) in NR1 format

The <source> parameter may be repeated up to 5 times.

The :AUToscale command evaluates all input signals and sets the correct conditions to display the signals. This is the same as pressing the **[Auto Scale]** key on the front panel.

If one or more sources are specified, those specified sources will be enabled and all others blanked. The autoscale channels mode (see **" :AUToscale:CHANnels "** on page 222) is set to DISPlayed channels. Then, the autoscale is performed.

When the :AUToscale command is sent, the following conditions are affected and actions are taken:

- Thresholds.
- Channels with activity around the trigger point are turned on, others are turned off.
- Channels are reordered on screen; analog channel 1 first, followed by the remaining analog channels, then the digital channels 0-15.
- Delay is set to 0 seconds.
- Time/Div.

The :AUToscale command does not affect the following conditions:

- Label names.
- Trigger conditioning.

The :AUToscale command turns off the following items:

- Cursors.
- Measurements.
- Math waveforms.
- Reference waveforms.
- Zoomed (delayed) time base mode.

For further information on :AUToscale, see the *User's Guide*.

- See Also
- ["Introduction to Root \(:\) Commands"](#) on page 216
 - [":AUToscale:CHANnels"](#) on page 222
 - [":AUToscale:AMODE"](#) on page 221

Example Code

```
' AUTOSCALE - This command evaluates all the input signals and sets  
' the correct conditions to display all of the active signals.  
myScope.WriteString ":AUToscale" ' Same as pressing Auto Scale key.
```

See complete example programs at: [Chapter 42](#), "Programming Examples," starting on page 1393

:AUToscale:AMODE

N (see [page 1384](#))

Command Syntax :AUToscale:AMODE <value>
 <value> ::= {NORMal | CURRent}

The :AUToscale:AMODE command specifies the acquisition mode that is set by subsequent :AUToscales.

- When NORMal is selected, an :AUToscale command sets the NORMal acquisition type and the RTIME (real-time) acquisition mode.
- When CURRent is selected, the current acquisition type and mode are kept on subsequent :AUToscales.

Use the :ACquire:TYPE and :ACquire:MODE commands to set the acquisition type and mode.

Query Syntax :AUToscale:AMODE?

The :AUToscale:AMODE? query returns the autoscale acquire mode setting.

Return Format <value><NL>
 <value> ::= {NORM | CURR}

- See Also**
- ["Introduction to Root \(:\) Commands"](#) on page 216
 - [":AUToscale"](#) on page 219
 - [":AUToscale:CHANnels"](#) on page 222
 - [":ACquire:TYPE"](#) on page 265
 - [":ACquire:MODE"](#) on page 257

:AUToscale:CHANnels

N (see [page 1384](#))

Command Syntax :AUToscale:CHANnels <value>
 <value> ::= {ALL | DISplayed}

The :AUToscale:CHANnels command specifies which channels will be displayed on subsequent :AUToscales.

- When ALL is selected, all channels that meet the requirements of :AUToscale will be displayed.
- When DISplayed is selected, only the channels that are turned on are autoscaled.

Use the :VIEW or :BLANK root commands to turn channels on or off.

Query Syntax :AUToscale:CHANnels?

The :AUToscale:CHANnels? query returns the autoscale channels setting.

Return Format <value><NL>
 <value> ::= {ALL | DISP}

- See Also**
- ["Introduction to Root \(:\) Commands"](#) on page 216
 - [":AUToscale"](#) on page 219
 - [":AUToscale:AMODE"](#) on page 221
 - [":VIEW"](#) on page 252
 - [":BLANK"](#) on page 224

:AUToscale:FDEBug

N (see [page 1384](#))

Command Syntax :AUToscale:FDEBug <on_off>
 <on_off> ::= {{1 | ON} | {0 | OFF}}

The :AUToscale:FDEBug command turns fast debug auto scaling on or off.

The Fast Debug option changes the behavior of :AUToscale to let you make quick visual comparisons to determine whether the signal being probed is a DC voltage, ground, or an active AC signal.

Channel coupling is maintained for easy viewing of oscillating signals.

Query Syntax :AUToscale:FDEBug?

The :AUToscale:FDEBug? query returns the current autoscale fast debug setting.

Return Format <on_off><NL>
 <on_off> ::= {1 | 0}

- See Also**
- ["Introduction to Root \(:\) Commands"](#) on page 216
 - [":AUToscale"](#) on page 219

:BLANK

N (see [page 1384](#))

Command Syntax

`:BLANK [<source>]`

`<source> ::= {CHANnel<n> | FUNction<m> | MATH<m> | FFT | SBUS{1 | 2}
| WMEMory<r>}`
for the DSO models

`<source> ::= {CHANnel<n> | DIGital<d> | POD{1 | 2}
| BUS{1 | 2} | FUNction<m> | MATH<m> | FFT | SBUS{1 | 2}
| WMEMory<r>}`
for the MSO models

`<n> ::= 1 to (# analog channels) in NR1 format`

`<d> ::= 0 to (# digital channels - 1) in NR1 format`

`<m> ::= 1 to (# math functions) in NR1 format`

`<r> ::= 1 to (# ref waveforms) in NR1 format`

The `:BLANK` command turns off (stops displaying) the specified channel, digital pod, math function, serial decode bus, or reference waveform location. The `:BLANK` command with no parameter turns off all sources.

NOTE

To turn on (start displaying) a channel, etc., use the `:VIEW` command. The `DISPlay` commands, `:CHANnel<n>:DISPlay`, `:FUNction:DISPlay`, `:POD<n>:DISPlay`, `:DIGital<n>:DISPlay`, `:SBUS<n>:DISPlay`, or `:WMEMory<r>:DISPlay`, are the preferred method to turn on/off a channel, etc.

NOTE

`MATH<m>` is an alias for `FUNction<m>`.

- See Also
- ["Introduction to Root \(:\) Commands"](#) on page 216
 - [":DISPlay:CLEar"](#) on page 350
 - [":CHANnel<n>:DISPlay"](#) on page 294
 - [":DIGital<d>:DISPlay"](#) on page 335
 - [":FUNction<m>:DISPlay"](#) on page 403
 - [":POD<n>:DISPlay"](#) on page 617
 - [":SBUS<n>:DISPlay"](#) on page 758
 - [":WMEMory<r>:DISPlay"](#) on page 1276
 - [":STATus"](#) on page 249
 - [":VIEW"](#) on page 252

- Example Code
- ["Example Code"](#) on page 252

:DIGitize

C (see [page 1384](#))

Command Syntax :DIGitize [<source>[,...,<source>]]

<source> ::= {CHANnel<n> | FUNction<m> | MATH<m> | FFT | SBUS{1 | 2}}
for the DSO models

<source> ::= {CHANnel<n> | DIGital<d> | POD{1 | 2}
| BUS{1 | 2} | FUNction<m> | MATH<m> | FFT | SBUS{1 | 2}}
for the MSO models

<n> ::= 1 to (# analog channels) in NR1 format

<d> ::= 0 to (# digital channels - 1) in NR1 format

<m> ::= 1 to (# math functions) in NR1 format

The <source> parameter may be repeated up to 5 times.

The :DIGitize command is a specialized RUN command. It causes the instrument to acquire waveforms according to the settings of the :ACQUIRE commands subsystem. When the acquisition is complete, the instrument is stopped.

If no argument is given, :DIGitize acquires the channels currently displayed. If no channels are displayed, all channels are acquired.

NOTE

The :DIGitize command is only executed when the :TIMEbase:MODE is MAIN or WINDOW.

NOTE

To halt a :DIGitize in progress, use the device clear command.

NOTE

MATH<m> is an alias for FUNction<m>.

- See Also**
- ["Introduction to Root \(:\) Commands"](#) on page 216
 - [":RUN"](#) on page 246
 - [":SINGLE"](#) on page 248
 - [":STOP"](#) on page 250
 - [":TIMEbase:MODE"](#) on page 1087
 - [Chapter 7](#), "ACQUIRE Commands," starting on page 253
 - [Chapter 34](#), "WAVEFORM Commands," starting on page 1195

Example Code

```
' Capture an acquisition using :DIGitize.  
' -----  
myScope.WriteString ":DIGitize CHANnel1"
```

See complete example programs at: [Chapter 42](#), "Programming Examples," starting on page 1393

:HWEenable (Hardware Event Enable Register)

N (see [page 1384](#))

Command Syntax :HWEenable <mask>
 <mask> ::= 16-bit integer

The :HWEenable command sets a mask in the Hardware Event Enable register. Set any of the following bits to "1" to enable bit 12 in the Operation Status Condition Register and potentially cause an SRQ (Service Request interrupt) to be generated.

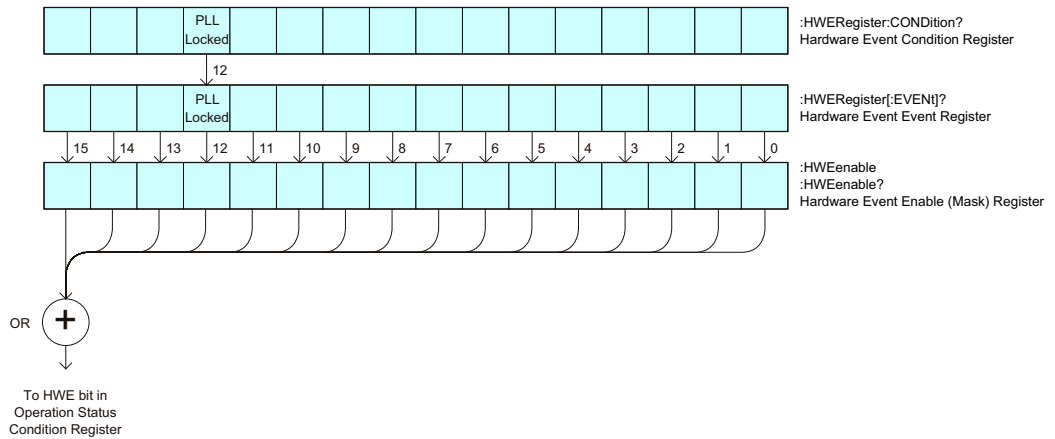

Table 79 Hardware Event Enable Register (HWEenable)

Bit	Name	Description	When Set (1 = High = True), Enables:
15-13	---	---	(Not used.)
12	PLL Locked	PLL Locked	This bit is for internal use and is not intended for general use.
11-0	---	---	(Not used.)

Query Syntax :HWEenable?

The :HWEenable? query returns the current value contained in the Hardware Event Enable register as an integer number.

Return Format <value><NL>
 <value> ::= integer in NR1 format.

- See Also**
- ["Introduction to Root \(:\) Commands"](#) on page 216
 - [":AER \(Arm Event Register\)"](#) on page 218
 - [":CHANnel<n>:PROTection"](#) on page 307
 - [":OPERRegister\[:EVENT\] \(Operation Status Event Register\)"](#) on page 239

- **":OVLenable (Overload Event Enable Register)"** on page 241
- **":OVLRegister (Overload Event Register)"** on page 243
- **"*STB (Read Status Byte)"** on page 208
- **"*SRE (Service Request Enable)"** on page 206

:HWERegister:CONDition (Hardware Event Condition Register)

N (see [page 1384](#))

Query Syntax :HWERegister:CONDition?

The :HWERegister:CONDition? query returns the integer value contained in the Hardware Event Condition Register.

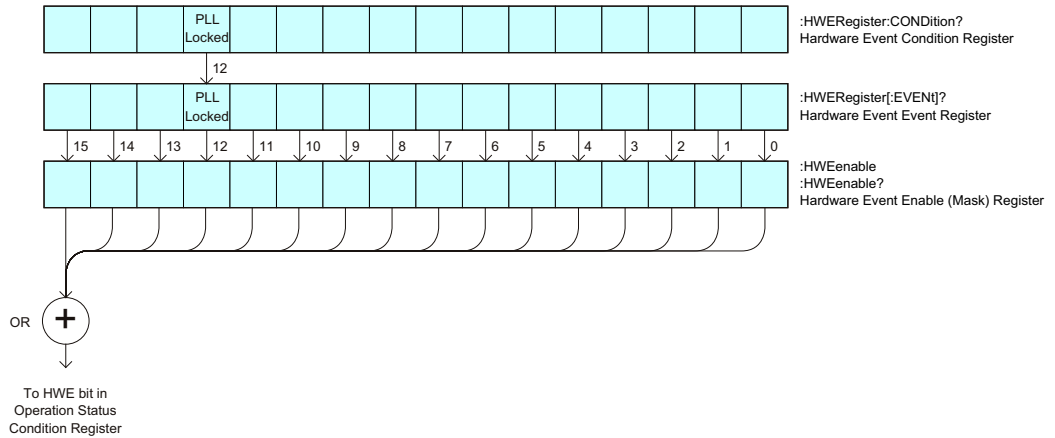

Table 80 Hardware Event Condition Register

Bit	Name	Description	When Set (1 = High = True), Indicates:
15-13	---	---	(Not used.)
12	PLL Locked	PLL Locked	This bit is for internal use and is not intended for general use.
11-0	---	---	(Not used.)

Return Format <value><NL>

<value> ::= integer in NR1 format.

- See Also**
- ["Introduction to Root \(:\) Commands"](#) on page 216
 - [":CHANnel<n>:PROTection"](#) on page 307
 - [":OPEE \(Operation Status Enable Register\)"](#) on page 235
 - [":OPERegister\[:EVENT\] \(Operation Status Event Register\)"](#) on page 239
 - [":OVLenable \(Overload Event Enable Register\)"](#) on page 241
 - [":OVLRegister \(Overload Event Register\)"](#) on page 243
 - ["*STB \(Read Status Byte\)"](#) on page 208
 - ["*SRE \(Service Request Enable\)"](#) on page 206

:HWERegister[:EVENT] (Hardware Event Event Register)

N (see [page 1384](#))

Query Syntax :HWERegister[:EVENT]?

The :HWERegister[:EVENT]? query returns the integer value contained in the Hardware Event Event Register.

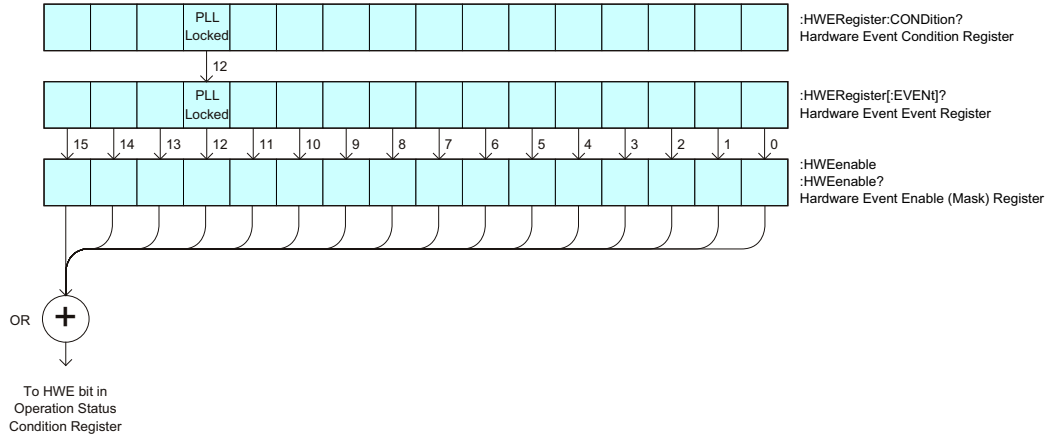

Table 81 Hardware Event Event Register

Bit	Name	Description	When Set (1 = High = True), Indicates:
15-13	---	---	(Not used.)
12	PLL Locked	PLL Locked	This bit is for internal use and is not intended for general use.
11-0	---	---	(Not used.)

Return Format <value><NL>

<value> ::= integer in NR1 format.

- See Also**
- ["Introduction to Root \(:\) Commands"](#) on page 216
 - [":CHANnel<n>:PROTection"](#) on page 307
 - [":OPEE \(Operation Status Enable Register\)"](#) on page 235
 - [":OPERegister:CONDition \(Operation Status Condition Register\)"](#) on page 237
 - [":OVLenable \(Overload Event Enable Register\)"](#) on page 241
 - [":OVLRegister \(Overload Event Register\)"](#) on page 243
 - ["*STB \(Read Status Byte\)"](#) on page 208
 - ["*SRE \(Service Request Enable\)"](#) on page 206

:MTEenable (Mask Test Event Enable Register)

N (see [page 1384](#))

Command Syntax :MTEenable <mask>

<mask> ::= 16-bit integer

The :MTEenable command sets a mask in the Mask Test Event Enable register. Set any of the following bits to "1" to enable bit 9 in the Operation Status Condition Register and potentially cause an SRQ (Service Request) interrupt to be generated.

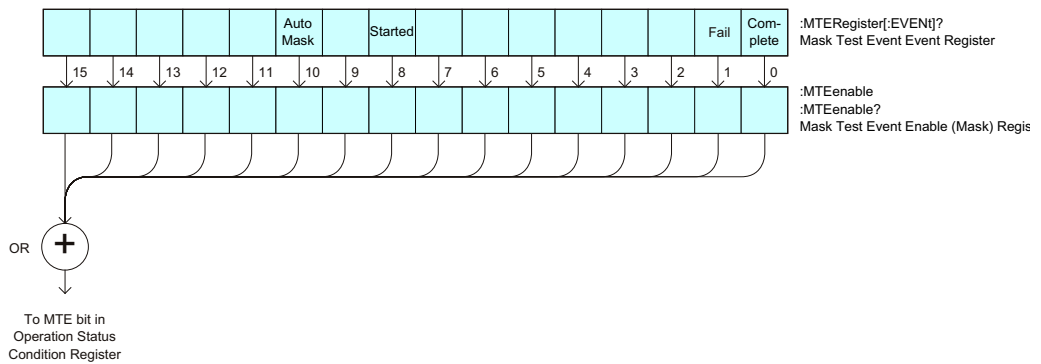

Table 82 Mask Test Event Enable Register (MTEenable)

Bit	Name	Description	When Set (1 = High = True), Enables:
15-11	---	---	(Not used.)
10	Auto Mask	Auto Mask Created	Auto mask creation completed.
9	---	---	(Not used.)
8	Started	Mask Testing Started	Mask testing started.
7-2	---	---	(Not used.)
1	Fail	Mask Test Fail	Mask test failed.
0	Complete	Mask Test Complete	Mask test is complete.

Query Syntax :MTEenable?

The :MTEenable? query returns the current value contained in the Mask Test Event Enable register as an integer number.

Return Format <value><NL>

<value> ::= integer in NR1 format.

- See Also**
- **"Introduction to Root (:) Commands"** on page 216
 - **":AER (Arm Event Register)"** on page 218
 - **":CHANnel<n>:PROTection"** on page 307
 - **":OPERRegister[:EVENT] (Operation Status Event Register)"** on page 239
 - **":OVLenable (Overload Event Enable Register)"** on page 241
 - **":OVLRegister (Overload Event Register)"** on page 243
 - **"*STB (Read Status Byte)"** on page 208
 - **"*SRE (Service Request Enable)"** on page 206

:MTERegister[:EVENT] (Mask Test Event Event Register)

N (see [page 1384](#))

Query Syntax :MTERegister[:EVENT]?

The :MTERegister[:EVENT]? query returns the integer value contained in the Mask Test Event Event Register and clears the register.

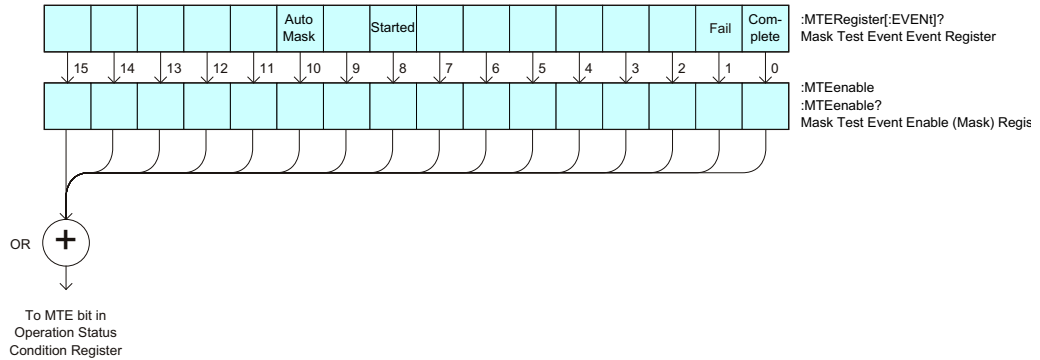

Table 83 Mask Test Event Event Register

Bit	Name	Description	When Set (1 = High = True), Indicates:
15-11	---	---	(Not used.)
10	Auto Mask	Auto Mask Created	Auto mask creation completed.
9	---	---	(Not used.)
8	Started	Mask Testing Started	Mask testing started.
7-2	---	---	(Not used.)
1	Fail	Mask Test Fail	The mask test failed.
0	Complete	Mask Test Complete	The mask test is complete.

Return Format <value><NL>

<value> ::= integer in NR1 format.

- See Also**
- ["Introduction to Root \(:\) Commands"](#) on page 216
 - [":CHANnel<n>:PROTection"](#) on page 307
 - [":OPEE \(Operation Status Enable Register\)"](#) on page 235
 - [":OPERegister:CONDition \(Operation Status Condition Register\)"](#) on page 237
 - [":OVLenable \(Overload Event Enable Register\)"](#) on page 241

- **":OVLRegister (Overload Event Register)"** on page 243
- **"*STB (Read Status Byte)"** on page 208
- **"*SRE (Service Request Enable)"** on page 206

:OPEE (Operation Status Enable Register)

C (see [page 1384](#))

Command Syntax :OPEE <mask>
 <mask> ::= 15-bit integer

The :OPEE command sets a mask in the Operation Status Enable register. Set any of the following bits to "1" to enable bit 7 in the Status Byte Register and potentially cause an SRQ (Service Request) interrupt to be generated.

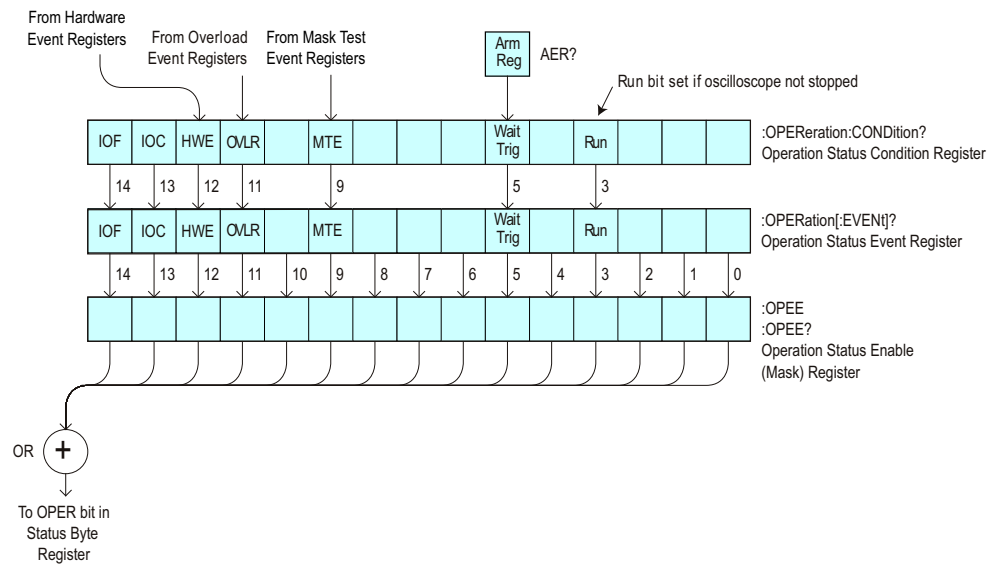

Table 84 Operation Status Enable Register (OPEE)

Bit	Name	Description	When Set (1 = High = True), Enables:
14	IOF	IO Operation Failed	Event when the IO operation fails.
13	IOC	IO Operation Complete	Event when the IO operation completes.
12	HWE	Hard ware Event	Event when hard ware event occurs.
11	OVL	Overload	Event when 50Ω input overload occurs.
10	---	---	(Not used.)
9	MTE	Mask Test Event	Event when mask test event occurs.
8-6	---	---	(Not used.)
5	Wait Trig	Wait Trig	Event when the trigger is armed.
4	---	---	(Not used.)

Table 84 Operation Status Enable Register (OPEE) (continued)

Bit	Name	Description	When Set (1 = High = True), Enables:
3	Run	Running	Event when the oscilloscope is running (not stopped).
2-0	---	---	(Not used.)

Query Syntax :OPEE?

The :OPEE? query returns the current value contained in the Operation Status Enable register as an integer number.

Return Format <value><NL>

<value> ::= integer in NR1 format.

- See Also**
- ["Introduction to Root \(:\) Commands"](#) on page 216
 - [":AER \(Arm Event Register\)"](#) on page 218
 - [":CHANnel<n>:PROTection"](#) on page 307
 - [":OPERRegister\[:EVENT\] \(Operation Status Event Register\)"](#) on page 239
 - [":OVLenable \(Overload Event Enable Register\)"](#) on page 241
 - [":OVLRegister \(Overload Event Register\)"](#) on page 243
 - ["*STB \(Read Status Byte\)"](#) on page 208
 - ["*SRE \(Service Request Enable\)"](#) on page 206

:OPERRegister:CONDition (Operation Status Condition Register)

C (see [page 1384](#))

Query Syntax :OPERRegister:CONDition?

The :OPERRegister:CONDition? query returns the integer value contained in the Operation Status Condition Register.

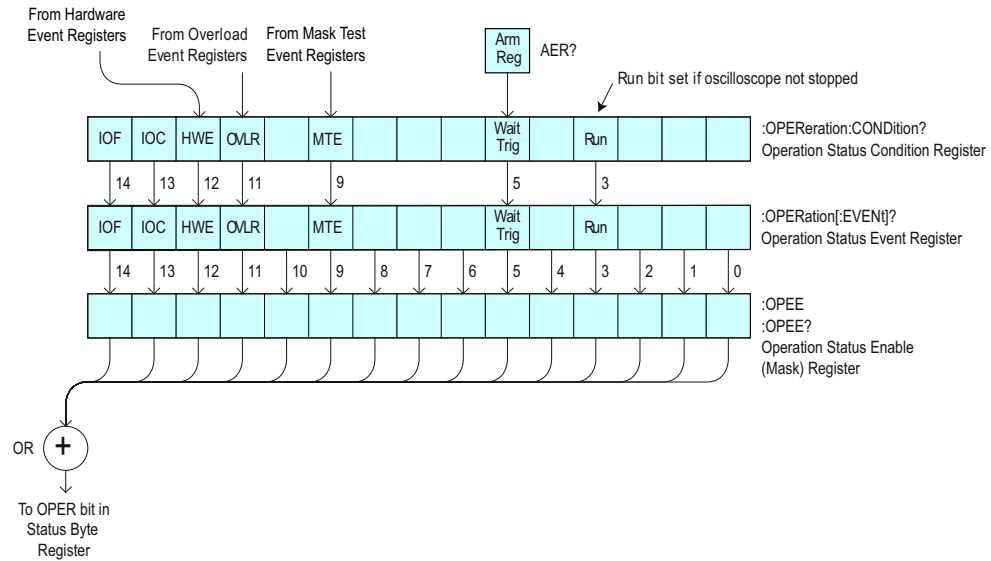

Table 85 Operation Status Condition Register

Bit	Name	Description	When Set (1 = High = True), Indicates:
14	IOF	IO Operation Failed	Event when the IO operation fails.
13	IOC	IO Operation Complete	Event when the IO operation completes.
12	HWE	Hard ware Event	Event when hard ware event occurs.
11	OVL	Overload	A 50Ω input overload has occurred.
10	---	---	(Not used.)
9	MTE	Mask Test Event	A mask test event has occurred.
8-6	---	---	(Not used.)
5	Wait Trig	Wait Trig	The trigger is armed (set by the Trigger Armed Event Register (TER)).
4	---	---	(Not used.)
3	Run	Running	The oscilloscope is running (not stopped).
2-0	---	---	(Not used.)

Return Format <value><NL>

<value> ::= integer in NR1 format.

- See Also**
- ["Introduction to Root \(:\) Commands"](#) on page 216
 - [":CHANnel<n>:PROTection"](#) on page 307
 - [":OPEE \(Operation Status Enable Register\)"](#) on page 235
 - [":OPERegister\[:EVENT\] \(Operation Status Event Register\)"](#) on page 239
 - [":OVLenable \(Overload Event Enable Register\)"](#) on page 241
 - [":OVLRegister \(Overload Event Register\)"](#) on page 243
 - ["*STB \(Read Status Byte\)"](#) on page 208
 - ["*SRE \(Service Request Enable\)"](#) on page 206
 - [":MTERegister\[:EVENT\] \(Mask Test Event Event Register\)"](#) on page 233
 - [":MTEenable \(Mask Test Event Enable Register\)"](#) on page 231

:OPERRegister[:EVENT] (Operation Status Event Register)

C (see [page 1384](#))

Query Syntax :OPERRegister[:EVENT]?

The :OPERRegister[:EVENT]? query returns the integer value contained in the Operation Status Event Register.

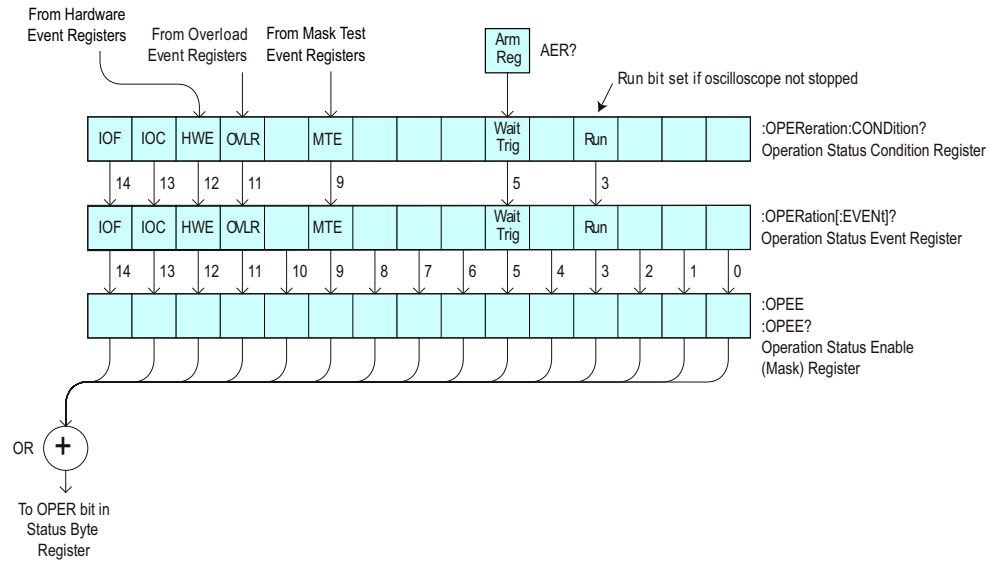

Table 86 Operation Status Event Register

Bit	Name	Description	When Set (1 = High = True), Indicates:
14	IOF	IO Operation Failed	Event when the IO operation fails.
13	IOC	IO Operation Complete	Event when the IO operation completes.
12	HWE	Hard ware Event	Event when hard ware event occurs.
11	OVL	Overload	A 50Ω input overload has occurred.
10	---	---	(Not used.)
9	MTE	Mask Test Event	A mask test event has occurred.
8-6	---	---	(Not used.)
5	Wait Trig	Wait Trig	The trigger is armed (set by the Trigger Armed Event Register (TER)).
4	---	---	(Not used.)
3	Run	Running	The oscilloscope has gone from a stop state to a single or running state.
2-0	---	---	(Not used.)

Return Format <value><NL>

<value> ::= integer in NR1 format.

- See Also**
- [":Introduction to Root \(:\) Commands"](#) on page 216
 - [":CHANnel<n>:PROTection"](#) on page 307
 - [":OPEE \(Operation Status Enable Register\)"](#) on page 235
 - [":OPERegister:CONDition \(Operation Status Condition Register\)"](#) on page 237
 - [":OVLenable \(Overload Event Enable Register\)"](#) on page 241
 - [":OVLRegister \(Overload Event Register\)"](#) on page 243
 - ["*STB \(Read Status Byte\)"](#) on page 208
 - ["*SRE \(Service Request Enable\)"](#) on page 206
 - [":MTERegister\[:EVENT\] \(Mask Test Event Event Register\)"](#) on page 233
 - [":MTEenable \(Mask Test Event Enable Register\)"](#) on page 231

:OVLenable (Overload Event Enable Register)

C (see [page 1384](#))

Command Syntax :OVLenable <enable_mask>
 <enable_mask> ::= 16-bit integer

The overload enable mask is an integer representing an input as described in the following table.

The :OVLenable command sets the mask in the Overload Event Enable Register and enables the reporting of the Overload Event Register. If an overvoltage is sensed on a 50Ω input, the input will automatically switch to 1 MΩ input impedance. If enabled, such an event will set bit 11 in the Operation Status Register.

NOTE

You can set analog channel input impedance to 50Ω on the 300 MHz, 500 MHz, and 1 GHz bandwidth oscilloscope models. On these same bandwidth models, if there are only two analog channels, you can also set external trigger input impedance to 50Ω.

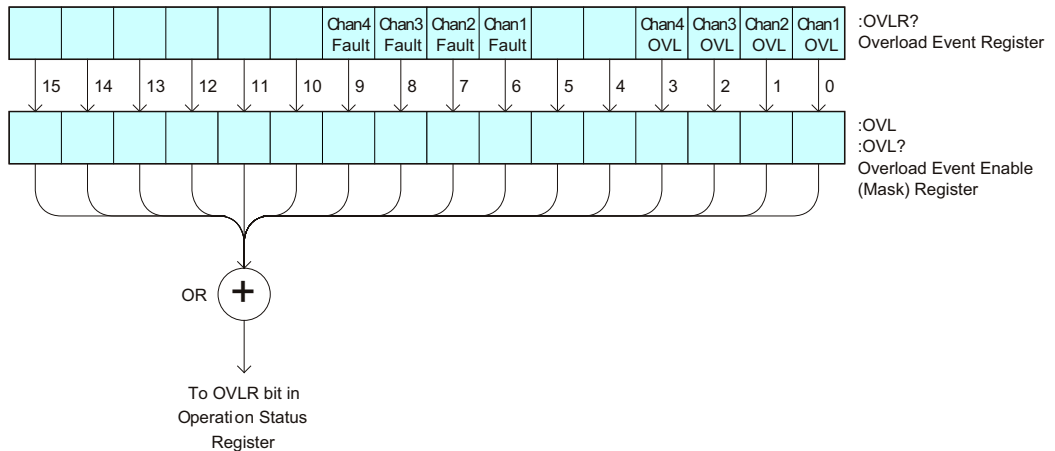

Table 87 Overload Event Enable Register (OVL)

Bit	Description	When Set (1 = High = True), Enables:
15-10	---	(Not used.)
9	Channel 4 Fault	Event when fault occurs on Channel 4 input.
8	Channel 3 Fault	Event when fault occurs on Channel 3 input.
7	Channel 2 Fault	Event when fault occurs on Channel 2 input.
6	Channel 1 Fault	Event when fault occurs on Channel 1 input.
5-4	---	(Not used.)

Table 87 Overload Event Enable Register (OVL) (continued)

Bit	Description	When Set (1 = High = True), Enables:
3	Channel 4 OVL	Event when overload occurs on Channel 4 input.
2	Channel 3 OVL	Event when overload occurs on Channel 3 input.
1	Channel 2 OVL	Event when overload occurs on Channel 2 input.
0	Channel 1 OVL	Event when overload occurs on Channel 1 input.

Query Syntax :OVLenable?

The :OVLenable query returns the current enable mask value contained in the Overload Event Enable Register.

Return Format <enable_mask><NL>

<enable_mask> ::= integer in NR1 format.

- See Also**
- ["Introduction to Root \(:\) Commands"](#) on page 216
 - [":CHANnel<n>:PROTection"](#) on page 307
 - [":OPEE \(Operation Status Enable Register\)"](#) on page 235
 - [":OPERegister:CONDition \(Operation Status Condition Register\)"](#) on page 237
 - [":OPERegister\[:EVENT\] \(Operation Status Event Register\)"](#) on page 239
 - [":OVLRegister \(Overload Event Register\)"](#) on page 243
 - ["*STB \(Read Status Byte\)"](#) on page 208
 - ["*SRE \(Service Request Enable\)"](#) on page 206

:OVLRegister (Overload Event Register)

C (see [page 1384](#))

Query Syntax :OVLRegister?

The :OVLRegister query returns the overload protection value stored in the Overload Event Register (OVL). If an overvoltage is sensed on a 50Ω input, the input will automatically switch to 1 MΩ input impedance. A "1" indicates an overload has occurred.

NOTE

You can set analog channel input impedance to 50Ω on the 300 MHz, 500 MHz, and 1 GHz bandwidth oscilloscope models. On these same bandwidth models, if there are only two analog channels, you can also set external trigger input impedance to 50Ω.

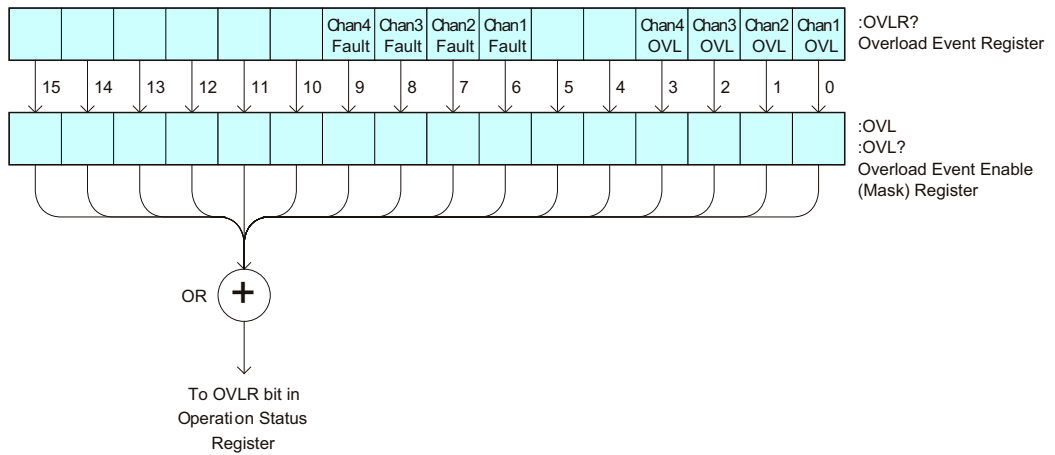

Table 88 Overload Event Register (OVL)

Bit	Description	When Set (1 = High = True), Indicates:
15-10	---	(Not used.)
9	Channel 4 Fault	Fault has occurred on Channel 4 input.
8	Channel 3 Fault	Fault has occurred on Channel 3 input.
7	Channel 2 Fault	Fault has occurred on Channel 2 input.
6	Channel 1 Fault	Fault has occurred on Channel 1 input.
5-4	---	(Not used.)
3	Channel 4 OVL	Overload has occurred on Channel 4 input.
2	Channel 3 OVL	Overload has occurred on Channel 3 input.

Table 88 Overload Event Register (OVLr) (continued)

Bit	Description	When Set (1 = High = True), Indicates:
1	Channel 2 OVL	Overload has occurred on Channel 2 input.
0	Channel 1 OVL	Overload has occurred on Channel 1 input.

Return Format <value><NL>

<value> ::= integer in NR1 format.

- See Also**
- ["Introduction to Root \(:\) Commands"](#) on page 216
 - [":CHANnel<n>:PROTection"](#) on page 307
 - [":OPEE \(Operation Status Enable Register\)"](#) on page 235
 - [":OVLenable \(Overload Event Enable Register\)"](#) on page 241
 - ["*STB \(Read Status Byte\)"](#) on page 208
 - ["*SRE \(Service Request Enable\)"](#) on page 206

:PRINT

C (see [page 1384](#))

Command Syntax :PRINT [<options>]

<options> ::= [<print option>][,...,<print option>]

<print option> ::= {COLor | GRAYscale | PRINter0 | PRINter1 | BMP8bit
| BMP | PNG | NOFactors | FACTors}

The <print option> parameter may be repeated up to 5 times.

The PRINT command formats the output according to the currently selected format (device). If an option is not specified, the value selected in the Print Config menu is used.

- See Also**
- ["Introduction to Root \(:\) Commands"](#) on page 216
 - ["Introduction to :HARDcopy Commands"](#) on page 432
 - [":HARDcopy:FACTors"](#) on page 435
 - [":HARDcopy:GRAYscale"](#) on page 1307
 - [":DISPlay:DATA"](#) on page 351

:RUN

C (see [page 1384](#))

Command Syntax :RUN

The :RUN command starts repetitive acquisitions. This is the same as pressing the Run key on the front panel.

- See Also**
- ["Introduction to Root \(:\) Commands"](#) on page 216
 - [":SINGLE"](#) on page 248
 - [":STOP"](#) on page 250

Example Code

```
' RUN_STOP - (not executed in this example)
' - RUN starts the data acquisition for the active waveform display.
' - STOP stops the data acquisition and turns off AUTOSTORE.
' myScope.WriteString ":RUN"      ' Start data acquisition.
' myScope.WriteString ":STOP"    ' Stop the data acquisition.
```

See complete example programs at: [Chapter 42](#), "Programming Examples," starting on page 1393

:SERial

N (see [page 1384](#))

Query Syntax :SERial?

The :SERial? query returns the serial number of the instrument.

Return Format: Unquoted string<NL>

See Also • ["Introduction to Root \(:\) Commands"](#) on page 216

:SINGle

C (see [page 1384](#))

Command Syntax :SINGle

The :SINGle command causes the instrument to acquire a single trigger of data. This is the same as pressing the Single key on the front panel.

- See Also**
- ["Introduction to Root \(:\) Commands"](#) on page 216
 - [":RUN"](#) on page 246
 - [":STOP"](#) on page 250

:STATus

N (see [page 1384](#))

Query Syntax

```
:STATus? <source>
```

```
<source> ::= {CHANnel<n> | FUNction<m> | MATH<m> | FFT | SBUS{1 | 2}
              | WMEMory<r>}
              for the DSO models
```

```
<source> ::= {CHANnel<n> | DIGital<d> | POD{1 | 2}
              | BUS{1 | 2} | FUNction<m> | MATH<m> | FFT | SBUS{1 | 2}
              | WMEMory<r>}
              for the MSO models
```

```
<n> ::= 1 to (# analog channels) in NR1 format
```

```
<d> ::= 0 to (# digital channels - 1) in NR1 format
```

```
<m> ::= 1 to (# math functions) in NR1 format
```

```
<r> ::= 1 to (# ref waveforms) in NR1 format
```

The :STATus? query reports whether the channel, function, serial decode bus, or reference waveform location specified by <source> is displayed.

NOTE

MATH<m> is an alias for FUNction<m>.

Return Format

```
<value><NL>
```

```
<value> ::= {1 | 0}
```

- See Also
- ["Introduction to Root \(:\) Commands"](#) on page 216
 - [":BLANK"](#) on page 224
 - [":CHANnel<n>:DISPlay"](#) on page 294
 - [":DIGital<d>:DISPlay"](#) on page 335
 - [":FUNction<m>:DISPlay"](#) on page 403
 - [":POD<n>:DISPlay"](#) on page 617
 - [":SBUS<n>:DISPlay"](#) on page 758
 - [":WMEMory<r>:DISPlay"](#) on page 1276
 - [":VIEW"](#) on page 252

:STOP

C (see [page 1384](#))

Command Syntax :STOP

The :STOP command stops the acquisition. This is the same as pressing the Stop key on the front panel.

- See Also**
- ["Introduction to Root \(:\) Commands"](#) on page 216
 - [":RUN"](#) on page 246
 - [":SINGLE"](#) on page 248

Example Code • ["Example Code"](#) on page 246

:TER (Trigger Event Register)

C (see [page 1384](#))

Query Syntax :TER?

The :TER? query reads the Trigger Event Register. After the Trigger Event Register is read, it is cleared. A one indicates a trigger has occurred. A zero indicates a trigger has not occurred.

The Trigger Event Register is summarized in the TRG bit of the Status Byte Register (STB). A Service Request (SRQ) can be generated when the TRG bit of the Status Byte transitions, and the TRG bit is set in the Service Request Enable register. The Trigger Event Register must be cleared each time you want a new service request to be generated.

Return Format <value><NL>

<value> ::= {1 | 0}; a 16-bit integer in NR1 format.

- See Also**
- ["Introduction to Root \(:\) Commands"](#) on page 216
 - ["*SRE \(Service Request Enable\)"](#) on page 206
 - ["*STB \(Read Status Byte\)"](#) on page 208

:VIEW

N (see [page 1384](#))

Command Syntax

`:VIEW <source>`

```
<source> ::= {CHANnel<n> | FUNction<m> | MATH<m> | FFT | SBUS{1 | 2}
             | WMEMory<r>}
             for DSO models
```

```
<source> ::= {CHANnel<n> | DIGital<d> | POD{1 | 2}
             | BUS{1 | 2} | FUNction<m> | MATH<m> | FFT | SBUS{1 | 2}
             | WMEMory<r>}
             for MSO models
```

`<n>` ::= 1 to (# analog channels) in NR1 format

`<d>` ::= 0 to (# digital channels - 1) in NR1 format

`<m>` ::= 1 to (# math functions) in NR1 format

`<r>` ::= 1 to (# ref waveforms) in NR1 format

The `:VIEW` command turns on the specified channel, function, serial decode bus, or reference waveform location.

NOTE

`MATH<m>` is an alias for `FUNction<m>`.

- See Also
- ["Introduction to Root \(:\) Commands"](#) on page 216
 - [":BLANK"](#) on page 224
 - [":CHANnel<n>:DISPlay"](#) on page 294
 - [":DIGital<d>:DISPlay"](#) on page 335
 - [":FUNction<m>:DISPlay"](#) on page 403
 - [":POD<n>:DISPlay"](#) on page 617
 - [":SBUS<n>:DISPlay"](#) on page 758
 - [":WMEMory<r>:DISPlay"](#) on page 1276
 - [":STATus"](#) on page 249

Example Code

```
' VIEW_BLANK - (not executed in this example)
' - VIEW turns on (starts displaying) a channel.
' - BLANK turns off (stops displaying) a channel.
' myScope.WriteString ":BLANK CHANnel1"      ' Turn channel 1 off.
' myScope.WriteString ":VIEW CHANnel1"      ' Turn channel 1 on.
```

See complete example programs at: [Chapter 42](#), "Programming Examples," starting on page 1393

7 :ACQure Commands

Set the parameters for acquiring and storing data. See "[Introduction to :ACQure Commands](#)" on page 253.

Table 89 :ACQure Commands Summary

Command	Query	Options and Query Returns
:ACQure:COMPLete <complete> (see page 255)	:ACQure:COMPLete? (see page 255)	<complete> ::= 100; an integer in NR1 format
:ACQure:COUNT <count> (see page 256)	:ACQure:COUNT? (see page 256)	<count> ::= an integer from 2 to 65536 in NR1 format
:ACQure:MODE <mode> (see page 257)	:ACQure:MODE? (see page 257)	<mode> ::= {RTIME ETIME SEGMENTed}
n/a	:ACQure:POINTs? (see page 258)	<# points> ::= an integer in NR1 format
:ACQure:SEGMENTed:ANALyze (see page 259)	n/a	n/a (with Option SGM)
:ACQure:SEGMENTed:COUNT <count> (see page 260)	:ACQure:SEGMENTed:COUNT? (see page 260)	<count> ::= an integer from 2 to 1000 in NR1 format (with Option SGM)
:ACQure:SEGMENTed:INDEX <index> (see page 261)	:ACQure:SEGMENTed:INDEX? (see page 261)	<index> ::= an integer from 1 to 1000 in NR1 format (with Option SGM)
n/a	:ACQure:SRATE? (see page 264)	<sample_rate> ::= sample rate (samples/s) in NR3 format
:ACQure:TYPE <type> (see page 265)	:ACQure:TYPE? (see page 265)	<type> ::= {NORMAL AVERAGE HRESolution PEAK}

Introduction to :ACQure Commands The ACQure subsystem controls the way in which waveforms are acquired. These acquisition types are available: normal, averaging, peak detect, and high resolution.

Normal

The :ACquire:TYPE NORMal command sets the oscilloscope in the normal acquisition mode. For the majority of user models and signals, NORMal mode yields the best oscilloscope picture of the waveform.

Averaging

The :ACquire:TYPE AVERage command sets the oscilloscope in the averaging mode. You can set the count by sending the :ACquire:COUNT command followed by the number of averages. In this mode, the value for averages is an integer from 2 to 65536. The COUNT value determines the number of averages that must be acquired.

High-Resolution

The :ACquire:TYPE HRESolution command sets the oscilloscope in the high-resolution mode (also known as *smoothing*). This mode is used to reduce noise at slower sweep speeds where the digitizer samples faster than needed to fill memory for the displayed time range. Instead of decimating samples, they are averaged together to provide the value for one display point. The slower the sweep speed, the greater the number of samples that are averaged together for each display point.

Peak Detect

The :ACquire:TYPE PEAK command sets the oscilloscope in the peak detect mode. In this mode, :ACquire:COUNT has no meaning.

Reporting the Setup

Use :ACquire? to query setup information for the ACquire subsystem.

Return Format

The following is a sample response from the :ACquire? query. In this case, the query was issued following a *RST command.

```
:ACQ:MODE RTIM;TYPE NORM;COMP 100;COUNT 8;SEGM:COUN 2
```

:ACquire:COMplete

C (see [page 1384](#))

Command Syntax :ACquire:COMplete <complete>
<complete> ::= 100; an integer in NR1 format

The :ACquire:COMplete command affects the operation of the :DIGitize command. It specifies the minimum completion criteria for an acquisition. The parameter determines the percentage of the time buckets that must be "full" before an acquisition is considered complete. If :ACquire:TYPE is NORMal, it needs only one sample per time bucket for that time bucket to be considered full.

The only legal value for the :COMplete command is 100. All time buckets must contain data for the acquisition to be considered complete.

Query Syntax :ACquire:COMplete?

The :ACquire:COMplete? query returns the completion criteria (100) for the currently selected mode.

Return Format <completion_criteria><NL>
<completion_criteria> ::= 100; an integer in NR1 format

- See Also**
- ["Introduction to :ACquire Commands"](#) on page 253
 - [":ACquire:TYPE"](#) on page 265
 - [":DIGitize"](#) on page 225
 - [":WAVeform:POINts"](#) on page 1208

Example Code

```
' ACQUIRE_COMPLETE - Specifies the minimum completion criteria for
' an acquisition. The parameter determines the percentage of time
' buckets needed to be "full" before an acquisition is considered
' to be complete.
myScope.WriteString ":ACquire:COMplete 100"
```

See complete example programs at: [Chapter 42](#), "Programming Examples," starting on page 1393

:ACquire:COUNT

C (see [page 1384](#))

Command Syntax :ACquire:COUNT <count>
 <count> ::= integer in NR1 format

In averaging mode, the :ACquire:COUNT command specifies the number of values to be averaged for each time bucket before the acquisition is considered to be complete for that time bucket. When :ACquire:TYPE is set to AVERage, the count can be set to any value from 2 to 65536.

NOTE

The :ACquire:COUNT 1 command has been deprecated. The AVERage acquisition type with a count of 1 is functionally equivalent to the HRESolution acquisition type; however, you should select the high-resolution acquisition mode with the :ACquire:TYPE HRESolution command instead.

Query Syntax :ACquire:COUNT?

The :ACquire:COUNT? query returns the currently selected count value for averaging mode.

Return Format <count_argument><NL>
 <count_argument> ::= an integer from 2 to 65536 in NR1 format

- See Also**
- ["Introduction to :ACquire Commands"](#) on page 253
 - [":ACquire:TYPE"](#) on page 265
 - [":DIGitize"](#) on page 225
 - [":WAVEform:COUNT"](#) on page 1204

:ACquire:MODE

C (see [page 1384](#))

Command Syntax :ACquire:MODE <mode>
 <mode> ::= {RTIME | SEGmented}

The :ACquire:MODE command sets the acquisition mode of the oscilloscope.

- The :ACquire:MODE RTIME command sets the oscilloscope in real time mode.

NOTE

The obsolete command ACquire:TYPE:REALtime is functionally equivalent to sending ACquire:MODE RTIME; TYPE NORMAl.

- The :ACquire:MODE SEGmented command sets the oscilloscope in segmented memory mode.

Query Syntax :ACquire:MODE?

The :ACquire:MODE? query returns the acquisition mode of the oscilloscope.

Return Format <mode_argument><NL>
 <mode_argument> ::= {RTIM | SEGM}

- See Also**
- ["Introduction to :ACquire Commands"](#) on page 253
 - [":ACquire:TYPE"](#) on page 265

:ACquire:POINts

C (see [page 1384](#))

Query Syntax :ACquire:POINts?

The :ACquire:POINts? query returns the number of data points that the hardware will acquire from the input signal. The number of points acquired is not directly controllable. To set the number of points to be transferred from the oscilloscope, use the command :WAVEform:POINts. The :WAVEform:POINts? query will return the number of points available to be transferred from the oscilloscope.

Return Format <points_argument><NL>

<points_argument> ::= an integer in NR1 format

- See Also**
- ["Introduction to :ACquire Commands"](#) on page 253
 - [":DIGitize"](#) on page 225
 - [":WAVEform:POINts"](#) on page 1208

:ACQUIRE:SEGMENTED:ANALYZE

N (see [page 1384](#))

Command Syntax :ACQUIRE:SEGMENTED:ANALYZE

NOTE

This command is available when the segmented memory option (Option SGM) is enabled.

This command calculates measurement statistics and/or infinite persistence over all segments that have been acquired. It corresponds to the front panel **Analyze Segments** softkey which appears in both the Measurement Statistics and Segmented Memory Menus.

In order to use this command, the oscilloscope must be stopped and in segmented acquisition mode, with either quick measurements or infinite persistence on.

- See Also**
- [":ACQUIRE:MODE"](#) on page 257
 - [":ACQUIRE:SEGMENTED:COUNT"](#) on page 260
 - ["Introduction to :ACQUIRE Commands"](#) on page 253

:ACquire:SEGmented:COUNT

N (see [page 1384](#))

Command Syntax :ACquire:SEGmented:COUNT <count>
 <count> ::= an integer from 2 to 1000 (w/4M memory) in NR1 format

NOTE

This command is available when the segmented memory option (Option SGM) is enabled.

The :ACquire:SEGmented:COUNT command sets the number of memory segments to acquire.

The segmented memory acquisition mode is enabled with the :ACquire:MODE command, and data is acquired using the :DIGitize, :SINGle, or :RUN commands. The number of memory segments in the current acquisition is returned by the :WAVEform:SEGmented:COUNT? query.

The maximum number of segments may be limited by the memory depth of your oscilloscope. For example, an oscilloscope with 1M memory allows a maximum of 250 segments.

Query Syntax :ACquire:SEGmented:COUNT?

The :ACquire:SEGmented:COUNT? query returns the current count setting.

Return Format <count><NL>
 <count> ::= an integer from 2 to 1000 (w/4M memory) in NR1 format

- See Also**
- [":ACquire:MODE"](#) on page 257
 - [":DIGitize"](#) on page 225
 - [":SINGle"](#) on page 248
 - [":RUN"](#) on page 246
 - [":WAVEform:SEGmented:COUNT"](#) on page 1215
 - [":ACquire:SEGmented:ANALyze"](#) on page 259
 - ["Introduction to :ACquire Commands"](#) on page 253

Example Code • ["Example Code"](#) on page 261

:ACquire:SEGmented:INDEX

N (see [page 1384](#))

Command Syntax :ACquire:SEGmented:INDEX <index>
 <index> ::= an integer from 1 to 1000 (w/4M memory) in NR1 format

NOTE

This command is available when the segmented memory option (Option SGM) is enabled.

The :ACquire:SEGmented:INDEX command sets the index into the memory segments that have been acquired.

The segmented memory acquisition mode is enabled with the :ACquire:MODE command. The number of segments to acquire is set using the :ACquire:SEGmented:COUNT command, and data is acquired using the :DIGitize, :SINGLE, or :RUN commands. The number of memory segments that have been acquired is returned by the :WAVEform:SEGmented:COUNT? query. The time tag of the currently indexed memory segment is returned by the :WAVEform:SEGmented:TTAG? query.

The maximum number of segments may be limited by the memory depth of your oscilloscope. For example, an oscilloscope with 1M memory allows a maximum of 250 segments.

Query Syntax :ACquire:SEGmented:INDEX?

The :ACquire:SEGmented:INDEX? query returns the current segmented memory index setting.

Return Format <index><NL>
 <index> ::= an integer from 1 to 1000 (w/4M memory) in NR1 format

- See Also**
- [":ACquire:MODE"](#) on page 257
 - [":ACquire:SEGmented:COUNT"](#) on page 260
 - [":DIGitize"](#) on page 225
 - [":SINGLE"](#) on page 248
 - [":RUN"](#) on page 246
 - [":WAVEform:SEGmented:COUNT"](#) on page 1215
 - [":WAVEform:SEGmented:TTAG"](#) on page 1216
 - [":ACquire:SEGmented:ANALyze"](#) on page 259
 - ["Introduction to :ACquire Commands"](#) on page 253

Example Code ' Segmented memory commands example.
 ' -----

```

Option Explicit

Public myMgr As VisaComLib.ResourceManager
Public myScope As VisaComLib.FormattedIO488
Public varQueryResult As Variant
Public strQueryResult As String

Private Declare Sub Sleep Lib "kernel32" (ByVal dwMilliseconds As Long)

Sub Main()

    On Error GoTo VisaComError

    ' Create the VISA COM I/O resource.
    Set myMgr = New VisaComLib.ResourceManager
    Set myScope = New VisaComLib.FormattedIO488
    Set myScope.IO = _
        myMgr.Open("USB0::0x0957::0x17A6::US50210029::0::INSTR")
    myScope.IO.Clear ' Clear the interface.

    ' Turn on segmented memory acquisition mode.
    myScope.WriteString ":ACquire:MODE SEGmented"
    myScope.WriteString ":ACquire:MODE?"
    strQueryResult = myScope.ReadString
    Debug.Print "Acquisition mode: " + strQueryResult

    ' Set the number of segments to 25.
    myScope.WriteString ":ACquire:SEGmented:COUNT 25"
    myScope.WriteString ":ACquire:SEGmented:COUNT?"
    strQueryResult = myScope.ReadString
    Debug.Print "Acquisition memory segments: " + strQueryResult

    ' If data will be acquired within the IO timeout:
    myScope.IO.Timeout = 10000
    myScope.WriteString ":DIGitize"
    Debug.Print ":DIGitize blocks until all segments acquired."
    myScope.WriteString ":WAVEform:SEGmented:COUNT?"
    varQueryResult = myScope.ReadNumber

    ' Or, to poll until the desired number of segments acquired:
    myScope.WriteString ":SINGle"
    Debug.Print ":SINGle does not block until all segments acquired."
    Do
        Sleep 100 ' Small wait to prevent excessive queries.
        myScope.WriteString ":WAVEform:SEGmented:COUNT?"
        varQueryResult = myScope.ReadNumber
    Loop Until varQueryResult = 25

    Debug.Print "Number of segments in acquired data: " _
        + FormatNumber(varQueryResult)

    Dim lngSegments As Long
    lngSegments = varQueryResult

    ' For each segment:
    Dim dblTimeTag As Double
    Dim lngI As Long

```

```

For lngI = lngSegments To 1 Step -1

    ' Set the segmented memory index.
    myScope.WriteString ":ACquire:SEGmented:INDEX " + CStr(lngI)
    myScope.WriteString ":ACquire:SEGmented:INDEX?"
    strQueryResult = myScope.ReadString
    Debug.Print "Acquisition memory segment index: " + strQueryResult

    ' Display the segment time tag.
    myScope.WriteString ":WAVEform:SEGmented:TTAG?"
    dblTimeTag = myScope.ReadNumber
    Debug.Print "Segment " + CStr(lngI) + " time tag: " _
        + FormatNumber(dblTimeTag, 12)

Next lngI

Exit Sub

VisaComError:
    MsgBox "VISA COM Error:" + vbCrLf + Err.Description

End Sub

```

:ACquire:SRATe

N (see [page 1384](#))

Query Syntax :ACquire:SRATe? [MAXimum]

The :ACquire:SRATe? query returns the current oscilloscope acquisition sample rate. The sample rate is not directly controllable.

When the MAXimum parameter is used, the oscilloscope's maximum possible sample rate is returned.

Return Format <sample_rate><NL>

<sample_rate> ::= sample rate in NR3 format

- See Also**
- ["Introduction to :ACquire Commands"](#) on page 253
 - [":ACquire:POINts"](#) on page 258

:ACquire:TYPE

C (see [page 1384](#))

Command Syntax :ACquire:TYPE <type>

<type> ::= {NORMAL | AVERage | HRESolution | PEAK}

The :ACquire:TYPE command selects the type of data acquisition that is to take place. The acquisition types are:

- NORMAL – sets the oscilloscope in the normal mode.
- AVERage – sets the oscilloscope in the averaging mode. You can set the count by sending the :ACquire:COUNT command followed by the number of averages. In this mode, the value for averages is an integer from 1 to 65536. The COUNT value determines the number of averages that must be acquired.

The AVERage type is not available when in segmented memory mode (:ACquire:MODE SEGmented).

- HRESolution – sets the oscilloscope in the high-resolution mode (also known as *smoothing*). This mode is used to reduce noise at slower sweep speeds where the digitizer samples faster than needed to fill memory for the displayed time range.

For example, if the digitizer samples at 200 MSa/s, but the effective sample rate is 1 MSa/s (because of a slower sweep speed), only 1 out of every 200 samples needs to be stored. Instead of storing one sample (and throwing others away), the 200 samples are averaged together to provide the value for one display point. The slower the sweep speed, the greater the number of samples that are averaged together for each display point.

- PEAK – sets the oscilloscope in the peak detect mode. In this mode, :ACquire:COUNT has no meaning.

The AVERage and HRESolution types can give you extra bits of vertical resolution. See the *User's Guide* for an explanation. When getting waveform data acquired using the AVERage and HRESolution types, be sure to use the WORD or ASCii waveform data formats to get the extra bits of vertical resolution.

NOTE

The obsolete command ACquire:TYPE:REALtime is functionally equivalent to sending ACquire:MODE RTIME; TYPE NORMAL.

Query Syntax :ACquire:TYPE?

The :ACquire:TYPE? query returns the current acquisition type.

Return Format <acq_type><NL>

<acq_type> ::= {NORM | AVER | HRES | PEAK}

See Also • ["Introduction to :ACquire Commands"](#) on page 253

- **":ACquire:COUNT"** on page 256
- **":ACquire:MODE"** on page 257
- **":DIGitize"** on page 225
- **":WAVEform:FORMat"** on page 1207
- **":WAVEform:TYPE"** on page 1222
- **":WAVEform:PREamble"** on page 1212

Example Code

```
' ACQUIRE_TYPE - Sets the acquisition mode, which can be NORMAL,  
' PEAK, or AVERAGE.  
myScope.WriteString ":ACquire:TYPE NORMal"
```

See complete example programs at: **Chapter 42**, "Programming Examples," starting on page 1393

8 :BUS<n> Commands

Control all oscilloscope functions associated with buses made up of digital channels. See "[Introduction to :BUS<n> Commands](#)" on page 268.

Table 90 :BUS<n> Commands Summary

Command	Query	Options and Query Returns
:BUS<n>:BIT<m> {{0 OFF} {1 ON}} (see page 269)	:BUS<n>:BIT<m>? (see page 269)	{0 1} <n> ::= 1 or 2; an integer in NR1 format <m> ::= 0-15; an integer in NR1 format
:BUS<n>:BITS <channel_list>, {{0 OFF} {1 ON}} (see page 270)	:BUS<n>:BITS? (see page 270)	<channel_list>, {0 1} <channel_list> ::= (@<m>, <m>:<m> ...) where "," is separator and ":" is range <n> ::= 1 or 2; an integer in NR1 format <m> ::= 0-15; an integer in NR1 format
:BUS<n>:CLear (see page 272)	n/a	<n> ::= 1 or 2; an integer in NR1 format
:BUS<n>:DISPlay {{0 OFF} {1 ON}} (see page 273)	:BUS<n>:DISPlay? (see page 273)	{0 1} <n> ::= 1 or 2; an integer in NR1 format

Table 90 :BUS<n> Commands Summary (continued)

Command	Query	Options and Query Returns
:BUS<n>:LAbel <string> (see page 274)	:BUS<n>:LAbel? (see page 274)	<string> ::= quoted ASCII string up to 10 characters <n> ::= 1 or 2; an integer in NR1 format
:BUS<n>:MASK <mask> (see page 275)	:BUS<n>:MASK? (see page 275)	<mask> ::= 32-bit integer in decimal, <nondecimal>, or <string> <nondecimal> ::= #Hnn...n where n ::= {0,...,9 A,...,F} for hexadecimal <nondecimal> ::= #Bnn...n where n ::= {0 1} for binary <string> ::= "0xnn...n" where n ::= {0,...,9 A,...,F} for hexadecimal <n> ::= 1 or 2; an integer in NR1 format

**Introduction to
:BUS<n>
Commands**

<n> ::= {1 | 2}

The BUS subsystem commands control the viewing, labeling, and digital channel makeup of two possible buses.

NOTE

These commands are only valid for the MSO models.

Reporting the Setup

Use :BUS<n>? to query setup information for the BUS subsystem.

Return Format

The following is a sample response from the :BUS1? query. In this case, the query was issued following a *RST command.

```
:BUS1:DISP 0;LAB "BUS1";MASK +255
```

:BUS<n>:BIT<m>

N (see [page 1384](#))

Command Syntax :BUS<n>:BIT<m> <display>

<display> ::= {{1 | ON} | {0 | OFF}}

<n> ::= An integer, 1 or 2, is attached as a suffix to BUS and defines the bus that is affected by the command.

<m> ::= An integer, 0,...,15, is attached as a suffix to BIT and defines the digital channel that is affected by the command.

The :BUS<n>:BIT<m> command includes or excludes the selected bit as part of the definition for the selected bus. If the parameter is a 1 (ON), the bit is included in the definition. If the parameter is a 0 (OFF), the bit is excluded from the definition. *Note:* BIT0-15 correspond to DIGital0-15.

NOTE

This command is only valid for the MSO models.

Query Syntax :BUS<n>:BIT<m>?

The :BUS<n>:BIT<m>? query returns the value indicating whether the specified bit is included or excluded from the specified bus definition.

Return Format <display><NL>

<display> ::= {0 | 1}

- See Also**
- ["Introduction to :BUS<n> Commands"](#) on page 268
 - [":BUS<n>:BITS"](#) on page 270
 - [":BUS<n>:CLEar"](#) on page 272
 - [":BUS<n>:DISPlay"](#) on page 273
 - [":BUS<n>:LABel"](#) on page 274
 - [":BUS<n>:MASK"](#) on page 275

Example Code

```
' Include digital channel 1 in bus 1:
myScope.WriteString ":BUS1:BIT1 ON"
```

:BUS<n>:BITS

N (see [page 1384](#))

Command Syntax :BUS<n>:BITS <channel_list>, <display>

<channel_list> ::= (@<m>,<m>:<m>, ...) where commas separate bits and colons define bit ranges.

<m> ::= An integer, 0,...,15, defines a digital channel affected by the command.

<display> ::= {{1 | ON} | {0 | OFF}}

<n> ::= An integer, 1 or 2, is attached as a suffix to BUS and defines the bus that is affected by the command.

The :BUS<n>:BITS command includes or excludes the selected bits in the channel list in the definition of the selected bus. If the parameter is a 1 (ON) then the bits in the channel list are included as part of the selected bus definition. If the parameter is a 0 (OFF) then the bits in the channel list are excluded from the definition of the selected bus.

NOTE

This command is only valid for the MSO models.

Query Syntax :BUS<n>:BITS?

The :BUS<n>:BITS? query returns the definition for the specified bus.

Return Format <channel_list>, <display><NL>

<channel_list> ::= (@<m>,<m>:<m>, ...) where commas separate bits and colons define bit ranges.

<display> ::= {0 | 1}

- See Also**
- ["Introduction to :BUS<n> Commands"](#) on page 268
 - [":BUS<n>:BIT<m>"](#) on page 269
 - [":BUS<n>:CLEar"](#) on page 272
 - [":BUS<n>:DISPlay"](#) on page 273
 - [":BUS<n>:LABel"](#) on page 274
 - [":BUS<n>:MASK"](#) on page 275

Example Code

```
' Include digital channels 1, 2, 4, 5, 6, 7, 8, and 9 in bus 1:
myScope.WriteString ":BUS1:BITS (@1,2,4:9), ON"

' Include digital channels 1, 5, 7, and 9 in bus 1:
myScope.WriteString ":BUS1:BITS (@1,5,7,9), ON"

' Include digital channels 1 through 15 in bus 1:
myScope.WriteString ":BUS1:BITS (@1:15), ON"
```

```
' Include digital channels 1 through 5, 8, and 14 in bus 1:  
myScope.WriteString ":BUS1:BITS (@1:5,8,14), ON"
```

:BUS<n>:CLEAr

N (see [page 1384](#))

Command Syntax :BUS<n>:CLEAr

<n> ::= An integer, 1 or 2, is attached as a suffix to BUS and defines the bus that is affected by the command.

The :BUS<n>:CLEAr command excludes all of the digital channels from the selected bus definition.

NOTE

This command is only valid for the MSO models.

-
- See Also**
- ["Introduction to :BUS<n> Commands"](#) on page 268
 - [":BUS<n>:BIT<m>"](#) on page 269
 - [":BUS<n>:BITS"](#) on page 270
 - [":BUS<n>:DISPlay"](#) on page 273
 - [":BUS<n>:LABel"](#) on page 274
 - [":BUS<n>:MASK"](#) on page 275

:BUS<n>:DISPlay

N (see [page 1384](#))

Command Syntax :BUS<n>:DISplay <value>

<value> ::= {{1 | ON} | {0 | OFF}}

<n> ::= An integer, 1 or 2, is attached as a suffix to BUS and defines the bus that is affected by the command.

The :BUS<n>:DISPlay command enables or disables the view of the selected bus.

NOTE

This command is only valid for the MSO models.

Query Syntax :BUS<n>:DISPlay?

The :BUS<n>:DISPlay? query returns the display value of the selected bus.

Return Format <value><NL>

<value> ::= {0 | 1}

- See Also**
- ["Introduction to :BUS<n> Commands"](#) on page 268
 - [":BUS<n>:BIT<m>"](#) on page 269
 - [":BUS<n>:BITS"](#) on page 270
 - [":BUS<n>:CLEar"](#) on page 272
 - [":BUS<n>:LABel"](#) on page 274
 - [":BUS<n>:MASK"](#) on page 275

:BUS<n>:LABel

N (see [page 1384](#))

Command Syntax :BUS<n>:LABel <quoted_string>

<quoted_string> ::= any series of 10 or less characters as a quoted ASCII string.

<n> ::= An integer, 1 or 2, is attached as a suffix to BUS and defines the bus that is affected by the command.

The :BUS<n>:LABel command sets the bus label to the quoted string. Setting a label for a bus will also result in the name being added to the label list.

NOTE

This command is only valid for the MSO models.

NOTE

Label strings are 10 characters or less, and may contain any commonly used ASCII characters. Labels with more than 10 characters are truncated to 10 characters.

Query Syntax :BUS<n>:LABel?

The :BUS<n>:LABel? query returns the name of the specified bus.

Return Format <quoted_string><NL>

<quoted_string> ::= any series of 10 or less characters as a quoted ASCII string.

- See Also**
- ["Introduction to :BUS<n> Commands"](#) on page 268
 - [":BUS<n>:BIT<m>"](#) on page 269
 - [":BUS<n>:BITS"](#) on page 270
 - [":BUS<n>:CLEar"](#) on page 272
 - [":BUS<n>:DISPlay"](#) on page 273
 - [":BUS<n>:MASK"](#) on page 275
 - [":CHANnel<n>:LABel"](#) on page 297
 - [":DISPlay:LABList"](#) on page 354
 - [":DIGital<d>:LABel"](#) on page 336

Example Code

```
' Set the bus 1 label to "Data":
myScope.WriteString ":BUS1:LABel 'Data'
```

:BUS<n>:MASK

N (see [page 1384](#))

Command Syntax :BUS<n>:MASK <mask>

<mask> ::= 32-bit integer in decimal, <nondecimal>, or <string>

<nondecimal> ::= #Hnn...n where n ::= {0,...,9 | A,...,F} for hexadecimal

<nondecimal> ::= #Bnn...n where n ::= {0 | 1} for binary

<string> ::= "0xnn...n" where n ::= {0,...,9 | A,...,F} for hexadecimal

<n> ::= An integer, 1 or 2, is attached as a suffix to BUS and defines the bus that is affected by the command.

The :BUS<n>:MASK command defines the bits included and excluded in the selected bus according to the mask. Set a mask bit to a "1" to include that bit in the selected bus, and set a mask bit to a "0" to exclude it.

NOTE

This command is only valid for the MSO models.

Query Syntax :BUS<n>:MASK?

The :BUS<n>:MASK? query returns the mask value for the specified bus.

Return Format <mask><NL> in decimal format

- See Also**
- ["Introduction to :BUS<n> Commands"](#) on page 268
 - [":BUS<n>:BIT<m>"](#) on page 269
 - [":BUS<n>:BITS"](#) on page 270
 - [":BUS<n>:CLEar"](#) on page 272
 - [":BUS<n>:DISPlay"](#) on page 273
 - [":BUS<n>:LABel"](#) on page 274

9 :CALibrate Commands

Utility commands for viewing calibration status and for starting the user calibration procedure. See "[Introduction to :CALibrate Commands](#)" on page 278.

Table 91 :CALibrate Commands Summary

Command	Query	Options and Query Returns
n/a	:CALibrate:DATE? (see page 279)	<return value> ::= <year>,<month>,<day>; all in NR1 format
:CALibrate:LABel <string> (see page 280)	:CALibrate:LABel? (see page 280)	<string> ::= quoted ASCII string up to 32 characters
:CALibrate:OUTPut <signal> (see page 281)	:CALibrate:OUTPut? (see page 281)	<signal> ::= {TRIGgers MASK WAVEgen WGEN1 WGEN2} Note: WAVE and WGEN1 are equivalent. Note: WGEN2 only available on models with 2 WaveGen outputs.
n/a	:CALibrate:PROTected? (see page 283)	{PROTected UNPRotected}
:CALibrate:START (see page 284)	n/a	n/a
n/a	:CALibrate:STATus? (see page 285)	<return value> ::= <status_code>,<status_string> <status_code> ::= an integer status code <status_string> ::= an ASCII status string
n/a	:CALibrate:TEMPeratur e? (see page 286)	<return value> ::= degrees C delta since last cal in NR3 format
n/a	:CALibrate:TIME? (see page 287)	<return value> ::= <hours>,<minutes>,<seconds>; all in NR1 format

**Introduction to
:CALibrate
Commands**

The CALibrate subsystem provides utility commands for:

- Determining the state of the calibration factor protection switch (CAL PROTECT).
- Saving and querying the calibration label string.
- Reporting the calibration time and date.
- Reporting changes in the temperature since the last calibration.
- Starting the user calibration procedure.

:CALibrate:DATE

N (see [page 1384](#))

Query Syntax :CALibrate:DATE?

The :CALibrate:DATE? query returns the date of the last calibration.

Return Format <date><NL>

<date> ::= year,month,day in NR1 format<NL>

See Also · ["Introduction to :CALibrate Commands"](#) on page 278

:CALibrate:LABel

N (see [page 1384](#))

Command Syntax :CALibrate:LABel <string>

<string> ::= quoted ASCII string of up to 32 characters in length, not including the quotes

The CALibrate:LABel command saves a string that is up to 32 characters in length into the instrument's non-volatile memory. The string may be used to record calibration dates or other information as needed.

Query Syntax :CALibrate:LABel?

The :CALibrate:LABel? query returns the contents of the calibration label string.

Return Format <string><NL>

<string> ::= unquoted ASCII string of up to 32 characters in length

See Also • ["Introduction to :CALibrate Commands"](#) on page 278

:CALibrate:OUTPut

N (see [page 1384](#))

Command Syntax :CALibrate:OUTPut <signal>

<signal> ::= {TRIGgers | MASK | WAVEgen | WGEN1 | NFC}

Note: WAVE and WGEN1 are equivalent.

The CALibrate:OUTPut command sets the signal that is available on the rear panel TRIG OUT BNC:

- TRIGgers – pulse when a trigger event occurs.
- MASK – signal from mask test indicating a failure.
- WAVEgen, WGEN1 – waveform generator sync output signal. This signal depends on the :WGEN<w>:FUNction setting:

Waveform Type	Sync Signal Characteristics
SINusoid, SQUare, RAMP, PULSE, SINC, EXPRise, EXPFall, GAUSSian	The Sync signal is a TTL positive pulse that occurs when the waveform rises above zero volts (or the DC offset value).
DC, NOISe, CARDiac	N/A

- NFC – This option is available in the Near Field Communication (NFC) trigger mode when the ATRigger (Arm & Trigger) trigger event is selected (see [":TRIGger:NFC:TEVent"](#) on page 1141). The ATRigger trigger event lets you arm the oscilloscope on one event and then trigger on a second event or after a specified timeout period if the second event does not occur.

When :CALibrate:OUTPut is NFC and the specified event arms, the *TRIG OUTBNC* goes high. The oscilloscope waits until a second event is found or until the specified timeout period expires and then triggers.

- For NFC-A, the second event is SDD_REQ.
- For NFC-B, the second event is ATTRIB.
- For NFC-F, the second event is ATR_REQ.

When the oscilloscope triggers, the *TRIG OUTBNC* line goes low.

Query Syntax :CALibrate:OUTPut?

The :CALibrate:OUTPut query returns the current source of the TRIG OUT BNC signal.

Return Format <signal><NL>

<signal> ::= {TRIG | MASK | WAVE | NFC}

- See Also**
- ["Introduction to :CALibrate Commands"](#) on page 278
 - [":WGEN<w>:FUNction"](#) on page 1243

:CALibrate:PROTeCted

N (see [page 1384](#))

Query Syntax :CALibrate:PROTeCted?

The :CALibrate:PROTeCted? query returns the rear-panel calibration protect (CAL PROTECT) button state. The value PROTeCted indicates calibration is disabled, and UNPROTeCted indicates calibration is enabled.

Return Format <switch><NL>

<switch> ::= {PROTeCted | UNPROTeCted}

See Also · ["Introduction to :CALibrate Commands"](#) on page 278

:CALibrate:START

N (see [page 1384](#))

Command Syntax :CALibrate:START

The CALibrate:START command starts the user calibration procedure.

NOTE

Before starting the user calibration procedure, you must set the rear panel CALIBRATION switch to UNPROTECTED, and you must connect BNC cables from the TRIG OUT connector to the analog channel inputs. See the *User's Guide* for details.

-
- See Also**
- ["Introduction to :CALibrate Commands"](#) on page 278
 - [":CALibrate:PROTECTED"](#) on page 283

:CALibrate:STATus

N (see [page 1384](#))

Query Syntax :CALibrate:STATus?

The :CALibrate:STATus? query returns the summary results of the last user calibration procedure.

Return Format <return value><NL>

<return value> ::= <status_code>,<status_string>

<status_code> ::= an integer status code

<status_string> ::= an ASCII status string

The status codes and strings can be:

Status Code	Status String
+0	Calibrated
-1	Not Calibrated

See Also · ["Introduction to :CALibrate Commands"](#) on page 278

:CALibrate:TEMPerature

N (see [page 1384](#))

Query Syntax :CALibrate:TEMPerature?

The :CALibrate:TEMPerature? query returns the change in temperature since the last user calibration procedure.

Return Format <return value><NL>

<return value> ::= degrees C delta since last cal in NR3 format

See Also · ["Introduction to :CALibrate Commands"](#) on page 278

:CALibrate:TIME

N (see [page 1384](#))

Query Syntax :CALibrate:TIME?

The :CALibrate:TIME? query returns the time of the last calibration.

Return Format <date><NL>

<date> ::= hour,minutes,seconds in NR1 format

See Also · ["Introduction to :CALibrate Commands"](#) on page 278

10 :CHANnel<n> Commands

Control all oscilloscope functions associated with individual analog channels or groups of channels. See "[Introduction to :CHANnel<n> Commands](#)" on page 291.

Table 92 :CHANnel<n> Commands Summary

Command	Query	Options and Query Returns
:CHANnel<n>:BWLimit { {0 OFF} {1 ON} } (see page 292)	:CHANnel<n>:BWLimit? (see page 292)	{0 1} <n> ::= 1 to (# analog channels) in NR1 format
:CHANnel<n>:COUpling <coupling> (see page 293)	:CHANnel<n>:COUpling? (see page 293)	<coupling> ::= {AC DC} <n> ::= 1 to (# analog channels) in NR1 format
:CHANnel<n>:DISPlay { {0 OFF} {1 ON} } (see page 294)	:CHANnel<n>:DISPlay? (see page 294)	{0 1} <n> ::= 1 to (# analog channels) in NR1 format
:CHANnel<n>:IMPedance <impedance> (see page 295)	:CHANnel<n>:IMPedance? (see page 295)	<impedance> ::= {ONEMeg FIFTy} <n> ::= 1 to (# analog channels) in NR1 format
:CHANnel<n>:INVert { {0 OFF} {1 ON} } (see page 296)	:CHANnel<n>:INVert? (see page 296)	{0 1} <n> ::= 1 to (# analog channels) in NR1 format
:CHANnel<n>:LABel <string> (see page 297)	:CHANnel<n>:LABel? (see page 297)	<string> ::= any series of 32 or less ASCII characters enclosed in quotation marks <n> ::= 1 to (# analog channels) in NR1 format
:CHANnel<n>:OFFSet <offset>[suffix] (see page 298)	:CHANnel<n>:OFFSet? (see page 298)	<offset> ::= Vertical offset value in NR3 format [suffix] ::= {V mV} <n> ::= 1-2 or 1-4; in NR1 format
:CHANnel<n>:PROBe <attenuation> (see page 299)	:CHANnel<n>:PROBe? (see page 299)	<attenuation> ::= Probe attenuation ratio in NR3 format <n> ::= 1-2 or 1-4r in NR1 format

Table 92 :CHANnel<n> Commands Summary (continued)

Command	Query	Options and Query Returns
:CHANnel<n>:PROBe:HEAD[:TYPE] <head_param> (see page 300)	:CHANnel<n>:PROBe:HEAD[:TYPE]? (see page 300)	<head_param> ::= {SEND0 SEND6 SEND12 SEND20 DIFF0 DIFF6 DIFF12 DIFF20 NONE} <n> ::= 1 to (# analog channels) in NR1 format
n/a	:CHANnel<n>:PROBe:ID? (see page 301)	<probe id> ::= unquoted ASCII string up to 11 characters <n> ::= 1 to (# analog channels) in NR1 format
:CHANnel<n>:PROBe:MMODel <value> (see page 302)	:CHANnel<n>:PROBe:MMODel? (see page 302)	<value> ::= {P5205 P5210 P6205 P6241 P6243 P6245 P6246 P6247 P6248 P6249 P6250 P6251 P670X P671X TCP202} <n> ::= 1 to (# analog channels) in NR1 format
:CHANnel<n>:PROBe:RSEnse <value> (see page 303)	:CHANnel<n>:PROBe:RSEnse? (see page 303)	<value> ::= Ohms in NR3 format <n> ::= 1 to (# analog channels) in NR1 format
:CHANnel<n>:PROBe:SKEW <skew_value> (see page 304)	:CHANnel<n>:PROBe:SKEW? (see page 304)	<skew_value> ::= -100 ns to +100 ns in NR3 format <n> ::= 1 to (# analog channels) in NR1 format
:CHANnel<n>:PROBe:STYPe <signal type> (see page 305)	:CHANnel<n>:PROBe:STYPe? (see page 305)	<signal type> ::= {DIFFerential SINGLE} <n> ::= 1 to (# analog channels) in NR1 format
:CHANnel<n>:PROBe:ZOOM {{0 OFF} {1 ON}} (see page 306)	:CHANnel<n>:PROBe:ZOOM? (see page 306)	<setting> ::= {0 1} <n> ::= 1 to (# analog channels) in NR1 format
:CHANnel<n>:PROtectio n (see page 307)	:CHANnel<n>:PROtectio n? (see page 307)	{NORM TRIP} <n> ::= 1 to (# analog channels) in NR1 format
:CHANnel<n>:RANGe <range>[suffix] (see page 308)	:CHANnel<n>:RANGe? (see page 308)	<range> ::= Vertical full-scale range value in NR3 format [suffix] ::= {V mV} <n> ::= 1 to (# analog channels) in NR1 format

Table 92 :CHANnel<n> Commands Summary (continued)

Command	Query	Options and Query Returns
:CHANnel<n>:SCALE <scale>[suffix] (see page 309)	:CHANnel<n>:SCALE? (see page 309)	<scale> ::= Vertical units per division value in NR3 format [suffix] ::= {V mV} <n> ::= 1 to (# analog channels) in NR1 format
:CHANnel<n>:UNITs <units> (see page 310)	:CHANnel<n>:UNITs? (see page 310)	<units> ::= {VOLT AMPere} <n> ::= 1 to (# analog channels) in NR1 format
:CHANnel<n>:VERNier {0 OFF} {1 ON} (see page 311)	:CHANnel<n>:VERNier? (see page 311)	{0 1} <n> ::= 1 to (# analog channels) in NR1 format

Introduction to :CHANnel<n> Commands

<n> ::= 1 to (# analog channels) in NR1 format

The CHANnel<n> subsystem commands control an analog channel (vertical or Y-axis of the oscilloscope). Channels are independently programmable for all offset, probe, coupling, bandwidth limit, inversion, vernier, and range (scale) functions. The channel number (1, 2, 3, or 4) specified in the command selects the analog channel that is affected by the command.

A label command provides identifying annotations of up to 10 characters.

You can toggle the channel displays on and off with the :CHANnel<n>:DISPlay command as well as with the root level commands :VIEW and :BLANK.

NOTE

The obsolete CHANnel subsystem is supported.

Reporting the Setup

Use :CHANnel1?, :CHANnel2?, :CHANnel3? or :CHANnel4? to query setup information for the CHANnel<n> subsystem.

Return Format

The following are sample responses from the :CHANnel<n>? query. In this case, the query was issued following a *RST command.

```
:CHAN1:RANG +40.0E+00;OFFS +0.00000E+00;COUP DC;IMP ONEM;DISP 1;BWL 0;
INV 0;LAB "1";UNIT VOLT;PROB +10E+00;PROB:SKEW +0.00E+00;STYP SING
```

:CHANnel<n>:BWLimit

C (see [page 1384](#))

Command Syntax :CHANnel<n>:BWLimit <bwlimit>

<bwlimit> ::= {{1 | ON} | {0 | OFF}}

<n> ::= 1 to (# analog channels) in NR1 format

The :CHANnel<n>:BWLimit command controls an internal low-pass filter. When the filter is on, the bandwidth of the specified channel is limited to approximately 25 MHz.

Query Syntax :CHANnel<n>:BWLimit?

The :CHANnel<n>:BWLimit? query returns the current setting of the low-pass filter.

Return Format <bwlimit><NL>

<bwlimit> ::= {1 | 0}

See Also • ["Introduction to :CHANnel<n> Commands"](#) on page 291

:CHANnel<n>:COUpling

C (see [page 1384](#))

Command Syntax :CHANnel<n>:COUpling <coupling>

<coupling> ::= {AC | DC}

<n> ::= 1 to (# analog channels) in NR1 format

The :CHANnel<n>:COUpling command selects the input coupling for the specified channel. The coupling for each analog channel can be set to AC or DC.

Query Syntax :CHANnel<n>:COUpling?

The :CHANnel<n>:COUpling? query returns the current coupling for the specified channel.

Return Format <coupling value><NL>

<coupling value> ::= {AC | DC}

See Also • ["Introduction to :CHANnel<n> Commands"](#) on page 291

:CHANnel<n>:DISPlay

C (see [page 1384](#))

Command Syntax :CHANnel<n>:DISPlay <display value>

<display value> ::= {{1 | ON} | {0 | OFF}}

<n> ::= 1 to (# analog channels) in NR1 format

The :CHANnel<n>:DISPlay command turns the display of the specified channel on or off.

Query Syntax :CHANnel<n>:DISPlay?

The :CHANnel<n>:DISPlay? query returns the current display setting for the specified channel.

Return Format <display value><NL>

<display value> ::= {1 | 0}

- See Also**
- ["Introduction to :CHANnel<n> Commands"](#) on page 291
 - [":VIEW"](#) on page 252
 - [":BLANK"](#) on page 224
 - [":STATus"](#) on page 249
 - [":POD<n>:DISPlay"](#) on page 617
 - [":DIGital<d>:DISPlay"](#) on page 335

:CHANnel<n>:IMPedance

C (see [page 1384](#))

Command Syntax :CHANnel<n>:IMPedance <impedance>

<impedance> ::= {ONEMeg | FIFTy}

<n> ::= 1 to (# analog channels) in NR1 format

The :CHANnel<n>:IMPedance command selects the input impedance setting for the specified analog channel. The legal values for this command are ONEMeg (1 M Ω) and FIFTy (50 Ω).

Query Syntax :CHANnel<n>:IMPedance?

The :CHANnel<n>:IMPedance? query returns the current input impedance setting for the specified channel.

Return Format <impedance value><NL>

<impedance value> ::= {ONEM | FIFT}

See Also • ["Introduction to :CHANnel<n> Commands"](#) on page 291

:CHANnel<n>:INVert

N (see [page 1384](#))

Command Syntax :CHANnel<n>:INVert <invert value>

<invert value> ::= {{1 | ON} | {0 | OFF}}

<n> ::= 1 to (# analog channels) in NR1 format

The :CHANnel<n>:INVert command selects whether or not to invert the input signal for the specified channel. The inversion may be 1 (ON/inverted) or 0 (OFF/not inverted).

Query Syntax :CHANnel<n>:INVert?

The :CHANnel<n>:INVert? query returns the current state of the channel inversion.

Return Format <invert value><NL>

<invert value> ::= {0 | 1}

See Also • ["Introduction to :CHANnel<n> Commands"](#) on page 291

:CHANnel<n>:LABel

N (see [page 1384](#))

Command Syntax :CHANnel<n>:LABel <string>
 <string> ::= quoted ASCII string
 <n> ::= 1 to (# analog channels) in NR1 format

NOTE

Label strings are 32 characters or less, and may contain any commonly used ASCII characters. Labels with more than 32 characters are truncated to 32 characters. Lower case characters are converted to upper case.

The :CHANnel<n>:LABel command sets the analog channel label to the string that follows. Setting a label for a channel also adds the name to the label list in non-volatile memory (replacing the oldest label in the list).

Query Syntax :CHANnel<n>:LABel?

The :CHANnel<n>:LABel? query returns the label associated with a particular analog channel.

Return Format <string><NL>
 <string> ::= quoted ASCII string

- See Also**
- ["Introduction to :CHANnel<n> Commands"](#) on page 291
 - [":DISPlay:LABel"](#) on page 353
 - [":DIGital<d>:LABel"](#) on page 336
 - [":DISPlay:LABList"](#) on page 354
 - [":BUS<n>:LABel"](#) on page 274

Example Code

```
' LABEL - This command allows you to write a name (32 characters
' maximum) next to the channel number. It is not necessary, but
' can be useful for organizing the display.
myScope.WriteString ":CHANnel1:LABel "CAL 1"" ' Label ch1 "CAL 1".
myScope.WriteString ":CHANnel2:LABel "CAL2"" ' Label ch1 "CAL2".
```

See complete example programs at: [Chapter 42](#), "Programming Examples," starting on page 1393

:CHANnel<n>:OFFSet

C (see [page 1384](#))

Command Syntax :CHANnel<n>:OFFSet <offset> [<suffix>]
 <offset> ::= Vertical offset value in NR3 format
 <suffix> ::= {V | mV}
 <n> ::= 1 to (# analog channels) in NR1 format

The :CHANnel<n>:OFFSet command sets the value that is represented at center screen for the selected channel. The range of legal values varies with the value set by the :CHANnel<n>:RANGe and :CHANnel<n>:SCALe commands. If you set the offset to a value outside of the legal range, the offset value is automatically set to the nearest legal value. Legal values are affected by the probe attenuation setting.

Query Syntax :CHANnel<n>:OFFSet?

The :CHANnel<n>:OFFSet? query returns the current offset value for the selected channel.

Return Format <offset><NL>
 <offset> ::= Vertical offset value in NR3 format

- See Also**
- ["Introduction to :CHANnel<n> Commands"](#) on page 291
 - [":CHANnel<n>:RANGe"](#) on page 308
 - [":CHANnel<n>:SCALe"](#) on page 309
 - [":CHANnel<n>:PROBe"](#) on page 299

:CHANnel<n>:PROBe

C (see [page 1384](#))

Command Syntax :CHANnel<n>:PROBe <attenuation>

<attenuation> ::= probe attenuation ratio in NR3 format

<n> ::= 1 to (# analog channels) in NR1 format

The obsolete attenuation values X1, X10, X20, X100 are also supported.

The :CHANnel<n>:PROBe command specifies the probe attenuation factor for the selected channel.

The probe attenuation factor may be from 0.001 to 10000.

This command does not change the actual input sensitivity of the oscilloscope. It changes the reference constants for scaling the display factors, for making automatic measurements, and for setting trigger levels.

If an AutoProbe probe is connected to the oscilloscope, the attenuation value cannot be changed from the sensed value. Attempting to set the oscilloscope to an attenuation value other than the sensed value produces an error.

Query Syntax :CHANnel<n>:PROBe?

The :CHANnel<n>:PROBe? query returns the current probe attenuation factor for the selected channel.

Return Format <attenuation><NL>

<attenuation> ::= probe attenuation ratio in NR3 format

See Also • ["Introduction to :CHANnel<n> Commands"](#) on page 291

• [":CHANnel<n>:RANGe"](#) on page 308

• [":CHANnel<n>:SCALE"](#) on page 309

• [":CHANnel<n>:OFFSet"](#) on page 298

Example Code

```
' CHANNEL_PROBE - Sets the probe attenuation factor for the
' selected channel. The probe attenuation factor may be set
' from 0.001 to 10000.
myScope.WriteString ":CHANnel1:PROBe 10" ' Set Probe to 10:1.
```

See complete example programs at: [Chapter 42](#), "Programming Examples," starting on page 1393

:CHANnel<n>:PROBe:HEAD[:TYPE]

C (see [page 1384](#))

Command Syntax

NOTE

This command is valid only for the 113xA Series probes.

```
:CHANnel<n>:PROBe:HEAD[:TYPE] <head_param>
<head_param> ::= {SEND0 | SEND6 | SEND12 | SEND20 | DIFF0 | DIFF6
                  | DIFF12 | DIFF20 | NONE}
<n> ::= {1 | 2 | 3 | 4}
```

The :CHANnel<n>:PROBe:HEAD[:TYPE] command sets an analog channel probe head type and dB value. You can choose from:

- SEND0 – Single-ended, 0dB.
- SEND6 – Single-ended, 6dB.
- SEND12 – Single-ended, 12dB.
- SEND20 – Single-ended, 20dB.
- DIFF0 – Differential, 0dB.
- DIFF6 – Differential, 6dB.
- DIFF12 – Differential, 12dB.
- DIFF20 – Differential, 20dB.

Query Syntax :CHANnel<n>:PROBe:HEAD[:TYPE]?

The :CHANnel<n>:PROBe:HEAD[:TYPE]? query returns the current probe head type setting for the selected channel.

Return Format <head_param><NL>

```
<head_param> ::= {SEND0 | SEND6 | SEND12 | SEND20 | DIFF0 | DIFF6
                  | DIFF12 | DIFF20 | NONE}
```

- See Also**
- ["Introduction to :CHANnel<n> Commands"](#) on page 291
 - [":CHANnel<n>:PROBe"](#) on page 299
 - [":CHANnel<n>:PROBe:ID"](#) on page 301
 - [":CHANnel<n>:PROBe:SKEW"](#) on page 304
 - [":CHANnel<n>:PROBe:STYPe"](#) on page 305

:CHANnel<n>:PROBe:ID

C (see [page 1384](#))

Query Syntax :CHANnel<n>:PROBe:ID?

<n> ::= 1 to (# analog channels) in NR1 format

The :CHANnel<n>:PROBe:ID? query returns the type of probe attached to the specified oscilloscope channel.

Return Format <probe id><NL>

<probe id> ::= unquoted ASCII string up to 11 characters

Some of the possible returned values are:

- 1131A
- 1132A
- 1134A
- 1147A
- 1153A
- 1154A
- 1156A
- 1157A
- 1158A
- 1159A
- AutoProbe
- E2621A
- E2622A
- E2695A
- E2697A
- HP1152A
- HP1153A
- NONE
- Probe
- Unknown
- Unsupported

See Also • ["Introduction to :CHANnel<n> Commands"](#) on page 291

:CHANnel<n>:PROBe:MMODEl

N (see [page 1384](#))

Command Syntax :CHANnel<n>:PROBe:MMODEl <value>

<value> ::= {P5205 | P5210 | P6205 | P6241 | P6243 | P6245 | P6246
| P6247 | P6248 | P6249 | P6250 | P6251 | P670X | P671X | TCP202}

<n> ::= 1 to (# analog channels) in NR1 format

The :CHANnel<n>:PROBe:MMODEl command sets the model number of the supported Tektronix probe.

Query Syntax :CHANnel<n>:PROBe:MMODEl?

The :CHANnel<n>:PROBe:MMODEl? query returns the model number setting.

Return Format <value><NL>

<value> ::= {P5205 | P5210 | P6205 | P6241 | P6243 | P6245 | P6246
| P6247 | P6248 | P6249 | P6250 | P6251 | P670X | P671X | TCP202}

See Also • [":CHANnel<n>:PROBe:ID"](#) on page 301

:CHANnel<n>:PROBe:RSENse

N (see [page 1384](#))

Command Syntax :CHANnel<n>:PROBe:RSENse <value>

<value> ::= Ohms in NR3 format

<n> ::= 1 to (# analog channels) in NR1 format

When the N2820A high-sensitivity current probe is used with the N2825A user-defined R-sense head, the :CHANnel<n>:PROBe:RSENse command specifies the value of the R-sense resistor that is being probed in the device under test (DUT).

Query Syntax :CHANnel<n>:PROBe:RSENse?

The :CHANnel<n>:PROBe:RSENse? query returns the R-sense resistor value setting.

Return Format <value><NL>

<value> ::= Ohms in NR3 format

- See Also**
- [":CHANnel<n>:PROBe:ZOOM"](#) on page 306
 - [":MEASure:DUAL:CHARge"](#) on page 504
 - [":MEASure:DUAL:VAMPlitude"](#) on page 505
 - [":MEASure:DUAL:VAverage"](#) on page 506
 - [":MEASure:DUAL:VBASe"](#) on page 507
 - [":MEASure:DUAL:VPP"](#) on page 508
 - [":MEASure:DUAL:VRMS"](#) on page 509

:CHANnel<n>:PROBe:SKEW

C (see [page 1384](#))

Command Syntax :CHANnel<n>:PROBe:SKEW <skew value>
 <skew value> ::= skew time in NR3 format
 <skew value> ::= -100 ns to +100 ns
 <n> ::= 1 to (# analog channels) in NR1 format

The :CHANnel<n>:PROBe:SKEW command sets the channel-to-channel skew factor for the specified channel. Each analog channel can be adjusted + or -100 ns for a total of 200 ns difference between channels. You can use the oscilloscope's probe skew control to remove cable-delay errors between channels.

Query Syntax :CHANnel<n>:PROBe:SKEW?

The :CHANnel<n>:PROBe:SKEW? query returns the current probe skew setting for the selected channel.

Return Format <skew value><NL>
 <skew value> ::= skew value in NR3 format

See Also • ["Introduction to :CHANnel<n> Commands"](#) on page 291

:CHANnel<n>:PROBe:STYPe

C (see [page 1384](#))

Command Syntax

NOTE

This command is valid only for the 113xA Series probes.

```
:CHANnel<n>:PROBe:STYPe <signal type>
<signal type> ::= {DIFFerential | SINGle}
<n> ::= 1 to (# analog channels) in NR1 format
```

The :CHANnel<n>:PROBe:STYPe command sets the channel probe signal type (STYPe) to differential or single-ended when using the 113xA Series probes and determines how offset is applied.

When single-ended is selected, the :CHANnel<n>:OFFSet command changes the offset value of the probe amplifier. When differential is selected, the :CHANnel<n>:OFFSet command changes the offset value of the channel amplifier.

Query Syntax :CHANnel<n>:PROBe:STYPe?

The :CHANnel<n>:PROBe:STYPe? query returns the current probe signal type setting for the selected channel.

Return Format <signal type><NL>

```
<signal type> ::= {DIFF | SING}
```

- See Also**
- ["Introduction to :CHANnel<n> Commands"](#) on page 291
 - [":CHANnel<n>:OFFSet"](#) on page 298

:CHANnel<n>:PROBe:ZOOM

N (see [page 1384](#))

Command Syntax :CHANnel<n>:PROBe:ZOOM {{0 | OFF} | {1 | ON}}

<n> ::= 1 to (# analog channels) in NR1 format

When the N2820A high-sensitivity current probe is used with both the Primary and Secondary cables, the :CHANnel<n>:PROBe:ZOOM command specifies whether this cable will have the Zoom In waveform (ON) or the Zoom Out waveform (OFF). The other cable will have the opposite waveform.

Query Syntax :CHANnel<n>:PROBe:ZOOM?

The :CHANnel<n>:PROBe:ZOOM? query returns the zoom setting.

Return Format <setting><NL>

<setting> ::= {0 | 1}

- See Also**
- [":CHANnel<n>:PROBe:RSENse"](#) on page 303
 - [":MEASure:DUAL:CHARge"](#) on page 504
 - [":MEASure:DUAL:VAMPLitude"](#) on page 505
 - [":MEASure:DUAL:VAverage"](#) on page 506
 - [":MEASure:DUAL:VBASe"](#) on page 507
 - [":MEASure:DUAL:VPP"](#) on page 508
 - [":MEASure:DUAL:VRMS"](#) on page 509

:CHANnel<n>:PROTection

N (see [page 1384](#))

Command Syntax :CHANnel<n>:PROTection[:CLEar]

<n> ::= 1 to (# analog channels) in NR1 format | 4}

When the analog channel input impedance is set to 50Ω, the input channels are protected against overvoltage. When an overvoltage condition is sensed, the input impedance for the channel is automatically changed to 1 MΩ.

The :CHANnel<n>:PROTection[:CLEar] command is used to clear (reset) the overload protection. It allows the channel to be used again in 50Ω mode after the signal that caused the overload has been removed from the channel input.

Reset the analog channel input impedance to 50Ω (see "[:CHANnel<n>:IMPedance](#)" on page 295) after clearing the overvoltage protection.

Query Syntax :CHANnel<n>:PROTection?

The :CHANnel<n>:PROTection query returns the state of the input protection for CHANnel<n>. If a channel input has experienced an overload, TRIP (tripped) will be returned; otherwise NORM (normal) is returned.

Return Format {NORM | TRIP}<NL>

- See Also**
- "[Introduction to :CHANnel<n> Commands](#)" on page 291
 - "[:CHANnel<n>:COUPLing](#)" on page 293
 - "[:CHANnel<n>:IMPedance](#)" on page 295
 - "[:CHANnel<n>:PROBe](#)" on page 299

:CHANnel<n>:RANGe

C (see [page 1384](#))

Command Syntax :CHANnel<n>:RANGe <range>[<suffix>]

<range> ::= vertical full-scale range value in NR3 format

<suffix> ::= {V | mV}

<n> ::= 1 to (# analog channels) in NR1 format

The :CHANnel<n>:RANGe command defines the full-scale vertical axis of the selected channel. When using 1:1 probe attenuation, legal values for the range are from 8 mV to 40 V.

If the probe attenuation is changed, the range value is multiplied by the probe attenuation factor.

Query Syntax :CHANnel<n>:RANGe?

The :CHANnel<n>:RANGe? query returns the current full-scale range setting for the specified channel.

Return Format <range_argument><NL>

<range_argument> ::= vertical full-scale range value in NR3 format

- See Also**
- ["Introduction to :CHANnel<n> Commands"](#) on page 291
 - [":CHANnel<n>:SCALE"](#) on page 309
 - [":CHANnel<n>:PROBE"](#) on page 299

Example Code

```
' CHANNEL_RANGE - Sets the full scale vertical range in volts. The
' range value is 8 times the volts per division.
myScope.WriteString ":CHANnel1:RANGe 8" ' Set the vertical range to
8 volts.
```

See complete example programs at: [Chapter 42](#), "Programming Examples," starting on page 1393

:CHANnel<n>:SCALE

N (see [page 1384](#))

Command Syntax :CHANnel<n>:SCALE <scale>[<suffix>]

<scale> ::= vertical units per division in NR3 format

<suffix> ::= {V | mV}

<n> ::= 1 to (# analog channels) in NR1 format

The :CHANnel<n>:SCALE command sets the vertical scale, or units per division, of the selected channel.

If the probe attenuation is changed, the scale value is multiplied by the probe's attenuation factor.

Query Syntax :CHANnel<n>:SCALE?

The :CHANnel<n>:SCALE? query returns the current scale setting for the specified channel.

Return Format <scale value><NL>

<scale value> ::= vertical units per division in NR3 format

- See Also**
- ["Introduction to :CHANnel<n> Commands"](#) on page 291
 - [":CHANnel<n>:RANGE"](#) on page 308
 - [":CHANnel<n>:PROBe"](#) on page 299

:CHANnel<n>:UNITs

N (see [page 1384](#))

Command Syntax :CHANnel<n>:UNITs <units>

<units> ::= {VOLT | AMPere}

<n> ::= 1 to (# analog channels) in NR1 format

The :CHANnel<n>:UNITs command sets the measurement units for the connected probe. Select VOLT for a voltage probe and select AMPere for a current probe. Measurement results, channel sensitivity, and trigger level will reflect the measurement units you select.

Query Syntax :CHANnel<n>:UNITs?

The :CHANnel<n>:UNITs? query returns the current units setting for the specified channel.

Return Format <units><NL>

<units> ::= {VOLT | AMP}

- See Also**
- ["Introduction to :CHANnel<n> Commands"](#) on page 291
 - [":CHANnel<n>:RANGe"](#) on page 308
 - [":CHANnel<n>:PROBe"](#) on page 299
 - [":EXTernal:UNITs"](#) on page 369

:CHANnel<n>:VERNier

N (see [page 1384](#))

Command Syntax :CHANnel<n>:VERNier <vernier value>

<vernier value> ::= {{1 | ON} | {0 | OFF}}

<n> ::= 1 to (# analog channels) in NR1 format

The :CHANnel<n>:VERNier command specifies whether the channel's vernier (fine vertical adjustment) setting is ON (1) or OFF (0).

Query Syntax :CHANnel<n>:VERNier?

The :CHANnel<n>:VERNier? query returns the current state of the channel's vernier setting.

Return Format <vernier value><NL>

<vernier value> ::= {0 | 1}

See Also • ["Introduction to :CHANnel<n> Commands"](#) on page 291

11 :COUNter Commands

When the optional DSOXDMCTR digital voltmeter and counter analysis feature is licensed, these commands control the counter feature. See "[Introduction to :COUNter Commands](#)" on page 314.

Table 93 :COUNter Commands Summary

Command	Query	Options and Query Returns
n/a	:COUNter:CURRent? (see page 315)	<value> ::= current counter value in NR3 format
:COUNter:ENABle {{0 OFF} {1 ON}} (see page 316)	:COUNter:ENABle? (see page 316)	{0 1}
:COUNter:MODE <mode> (see page 317)	:COUNter:MODE (see page 317)	<mode> ::= {FREQuency PERiod TOTalize}
:COUNter:NDIGits <value> (see page 318)	:COUNter:NDIGits (see page 318)	<value> ::= 3 to 8 in NR1 format
:COUNter:SOURce <source> (see page 319)	:COUNter:SOURce? (see page 319)	<source> ::= {CHANnel<n> TQEvent} <n> ::= 1 to (# analog channels) in NR1 format
:COUNter:TOTalize:CLEAr (see page 320)	n/a	n/a
:COUNter:TOTalize:GATE:ENABle {{0 OFF} {1 ON}} (see page 321)	:COUNter:TOTalize:GATE:ENABle? (see page 321)	{0 1}
:COUNter:TOTalize:GATE:POLarity <polarity> (see page 322)	:COUNter:TOTalize:GATE:POLarity? (see page 322)	<polarity> ::= {{NEGative FALLing} {POSitive RISing}}

Table 93 :COUNter Commands Summary (continued)

Command	Query	Options and Query Returns
:COUNter:TOTalize:GAT E:SOURce <source> (see page 323)	:COUNter:TOTalize:GAT E:SOURce? (see page 323)	<source> ::= CHANnel<n> <n> ::= 1 to (# analog channels) in NR1 format
:COUNter:TOTalize:SLO Pe <slope> (see page 324)	:COUNter:TOTalize:SLO Pe? (see page 324)	<slope> ::= {{NEGative FALLing} {POSitive RISing}}

Introduction to :COUNter Commands The :COUNter subsystem provides commands to control the counter feature.
Reporting the Setup

Use :COUNter? to query setup information for the COUNter subsystem.

Return Format

The following is a sample response from the :COUNter? query. In this case, the query was issued following the *RST command.

```
:COUN:ENAB 0;SOUR CHAN1;MODE FREQ;NDIG 5
```

:COUNter:CURRent

N (see [page 1384](#))

Query Syntax :COUNter:CURRent?

The :COUNter:CURRent? query returns the current counter value.

Return Format <value><NL>

<value> ::= current counter value in NR3 format

- See Also**
- [":COUNter:ENABLE"](#) on page 316
 - [":COUNter:MODE"](#) on page 317
 - [":COUNter:NDIGits"](#) on page 318
 - [":COUNter:SOURce"](#) on page 319

:COUNter:ENABle

N (see [page 1384](#))

Command Syntax :COUNter:ENABle {{0 | OFF} | {1 | ON}}

The :COUNter:ENABle command enables or disables the counter feature.

Query Syntax :COUNter:ENABle?

The :COUNter:ENABle? query returns whether the counter is enabled or disabled.

Return Format <off_on><NL>

{0 | 1}

- See Also**
- [":COUNter:CURRent"](#) on page 315
 - [":COUNter:MODE"](#) on page 317
 - [":COUNter:NDIGits"](#) on page 318
 - [":COUNter:SOURce"](#) on page 319

:COUNTER:MODE

N (see [page 1384](#))

Command Syntax :COUNTER:MODE <mode>

<mode> ::= {FREQUENCY | PERIOD | TOTALIZE}

The :COUNTER:MODE command sets the counter mode:

- FREQUENCY – the cycles per second (Hz) of the signal.
- PERIOD – the time periods of the signal's cycles.
- TOTALIZE – the count of edge events on the signal.

Query Syntax :COUNTER:MODE

The :COUNTER:MODE? query returns the counter mode setting.

Return Format <mode><NL>

<mode> ::= {FREQ | PER | TOT}

- See Also**
- [":COUNTER:CURRENT"](#) on page 315
 - [":COUNTER:ENABLE"](#) on page 316
 - [":COUNTER:NDIGITS"](#) on page 318
 - [":COUNTER:SOURCE"](#) on page 319
 - [":COUNTER:TOTALIZE:CLEAR"](#) on page 320
 - [":COUNTER:TOTALIZE:GATE:ENABLE"](#) on page 321
 - [":COUNTER:TOTALIZE:GATE:POLARITY"](#) on page 322
 - [":COUNTER:TOTALIZE:GATE:SOURCE"](#) on page 323
 - [":COUNTER:TOTALIZE:SLOPE"](#) on page 324

:COUNTER:NDIGits

N (see [page 1384](#))

Command Syntax :COUNTER:NDIGits <value>

<value> ::= 3 to 8 in NR1 format

The :COUNTER:NDIGits command sets the number of digits of resolution used for the frequency or period counter.

Higher resolutions require longer gate times, which cause the measurement times to be longer as well.

Query Syntax :COUNTER:NDIGits

The :COUNTER:NDIGits? query returns the currently set number of digits of resolution.

Return Format <value><NL>

<value> ::= 3 to 8 in NR1 format

- See Also**
- [":COUNTER:CURRENT"](#) on page 315
 - [":COUNTER:ENABLE"](#) on page 316
 - [":COUNTER:MODE"](#) on page 317
 - [":COUNTER:SOURCE"](#) on page 319
 - [":COUNTER:TOTALize:CLEar"](#) on page 320
 - [":COUNTER:TOTALize:GATE:ENABLE"](#) on page 321
 - [":COUNTER:TOTALize:GATE:POLarity"](#) on page 322
 - [":COUNTER:TOTALize:GATE:SOURCE"](#) on page 323
 - [":COUNTER:TOTALize:SLOPe"](#) on page 324

:COUNTER:SOURce

N (see [page 1384](#))

Command Syntax :COUNTER:SOURce <source>

<source> ::= {CHANnel<n> | TQEvent}

<n> ::= 1 to (# analog channels) in NR1 format

The :COUNTER:SOURce command selects the waveform source that the counter measures. You can select one of the analog input channels or the trigger qualified event signal.

With the TQEvent (trigger qualified event) source (available when the trigger mode is not EDGE), you can see how often trigger events are detected. This can be more often than when triggers actually occur, due to the oscilloscope's acquisition time or update rate capabilities. The TRIG OUT signal shows when triggers actually occur. Remember that the oscilloscope's trigger circuitry does not re-arm until the holdoff time occurs (:TRIGger:HOLDoff) and that the minimum holdoff time is 40 ns; therefore, the maximum trigger qualified event frequency that can be counted is 25 MHz.

Query Syntax :COUNTER:SOURce?

The :COUNTER:SOURce? query returns the currently set counter source channel.

Return Format <source><NL>

- See Also**
- [":COUNTER:CURRENT"](#) on page 315
 - [":COUNTER:ENABLE"](#) on page 316
 - [":COUNTER:MODE"](#) on page 317
 - [":COUNTER:NDIGits"](#) on page 318

:COUNTER:TOTALize:CLEar

N (see [page 1384](#))

Command Syntax :COUNTER:TOTALize:CLEar

The :COUNTER:TOTALize:CLEar command zeros the edge event counter.

- See Also**
- [":COUNTER:CURRENT"](#) on page 315
 - [":COUNTER:ENABLE"](#) on page 316
 - [":COUNTER:MODE"](#) on page 317
 - [":COUNTER:NDIGits"](#) on page 318
 - [":COUNTER:SOURce"](#) on page 319
 - [":COUNTER:TOTALize:GATE:ENABLE"](#) on page 321
 - [":COUNTER:TOTALize:GATE:POLarity"](#) on page 322
 - [":COUNTER:TOTALize:GATE:SOURce"](#) on page 323
 - [":COUNTER:TOTALize:SLOPe"](#) on page 324

:COUNTER:TOTALize:GATE:ENABLE

N (see [page 1384](#))

Command Syntax :COUNTER:TOTALize:GATE:ENABLE {{0 | OFF} | {1 | ON}}

The :COUNTER:TOTALize:GATE:ENABLE command enables or disables totalizer gating.

When totalizer gating is enabled, the totalizer only counts edges when a second gating signal polarity is true. The second gating signal can be one of the remaining analog channel inputs.

Query Syntax :COUNTER:TOTALize:GATE:ENABLE?

The :COUNTER:TOTALize:GATE:ENABLE? query returns whether totalizer gating is enabled or disabled.

Return Format <off_on><NL>

{0 | 1}

- See Also**
- [":COUNTER:CURRENT"](#) on page 315
 - [":COUNTER:ENABLE"](#) on page 316
 - [":COUNTER:MODE"](#) on page 317
 - [":COUNTER:NDIGITS"](#) on page 318
 - [":COUNTER:SOURCE"](#) on page 319
 - [":COUNTER:TOTALize:CLEAR"](#) on page 320
 - [":COUNTER:TOTALize:GATE:POLarity"](#) on page 322
 - [":COUNTER:TOTALize:GATE:SOURCE"](#) on page 323
 - [":COUNTER:TOTALize:SLOPe"](#) on page 324

:COUNTER:TOTALize:GATE:POLarity

N (see [page 1384](#))

Command Syntax :COUNTER:TOTALize:GATE:POLarity <polarity>

<polarity> ::= {NEGative | FALLing} | {POSitive | RISing}}

The :COUNTER:TOTALize:GATE:POLarity command specifies the gating signal condition under which totalizer edges are counted.

The gating signal is specified with the :COUNTER:TOTALize:GATE:SOURce command.

Query Syntax :COUNTER:TOTALize:GATE:POLarity?

The :COUNTER:TOTALize:GATE:POLarity? query returns the currently specified gating signal condition.

Return Format <polarity><NL>

<polarity> ::= {NEG | POS}

- See Also**
- [":COUNTER:CURRENT"](#) on page 315
 - [":COUNTER:ENABLE"](#) on page 316
 - [":COUNTER:MODE"](#) on page 317
 - [":COUNTER:NDIGits"](#) on page 318
 - [":COUNTER:SOURce"](#) on page 319
 - [":COUNTER:TOTALize:CLEar"](#) on page 320
 - [":COUNTER:TOTALize:GATE:ENABLE"](#) on page 321
 - [":COUNTER:TOTALize:GATE:SOURce"](#) on page 323
 - [":COUNTER:TOTALize:SLOPe"](#) on page 324

:COUNTER:TOTALize:GATE:SOURce

N (see [page 1384](#))

Command Syntax :COUNTER:TOTALize:GATE:SOURce <source>

<source> ::= CHANNEL<n>

<n> ::= 1 to (# analog channels) in NR1 format

The :COUNTER:TOTALize:GATE:SOURce command selects the analog channel that has the totalizer gating signal.

Query Syntax :COUNTER:TOTALize:GATE:SOURce?

The :COUNTER:TOTALize:GATE:SOURce? query returns the current totalizer gating signal source.

Return Format <source><NL>

- See Also**
- [":COUNTER:CURRENT"](#) on page 315
 - [":COUNTER:ENABLE"](#) on page 316
 - [":COUNTER:MODE"](#) on page 317
 - [":COUNTER:NDIGITS"](#) on page 318
 - [":COUNTER:SOURce"](#) on page 319
 - [":COUNTER:TOTALize:CLEar"](#) on page 320
 - [":COUNTER:TOTALize:GATE:ENABLE"](#) on page 321
 - [":COUNTER:TOTALize:GATE:POLarity"](#) on page 322
 - [":COUNTER:TOTALize:SLOPe"](#) on page 324

:COUNTER:TOTALize:SLOPe

N (see [page 1384](#))

Command Syntax :COUNTER:TOTALize:SLOPe <slope>
 <slope> ::= {{NEGative | FALLing} | {POSitive | RISing}}

The :COUNTER:TOTALize:SLOPe command specifies whether positive or negative edges are counted.

Query Syntax :COUNTER:TOTALize:SLOPe?

The :COUNTER:TOTALize:SLOPe? query returns the currently set slope specification.

Return Format <slope><NL>
 <slope> ::= {NEG | POS}

- See Also**
- [":COUNTER:CURRENT"](#) on page 315
 - [":COUNTER:ENABLE"](#) on page 316
 - [":COUNTER:MODE"](#) on page 317
 - [":COUNTER:NDIGits"](#) on page 318
 - [":COUNTER:SOURce"](#) on page 319
 - [":COUNTER:TOTALize:CLEar"](#) on page 320
 - [":COUNTER:TOTALize:GATE:ENABLE"](#) on page 321
 - [":COUNTER:TOTALize:GATE:POLarity"](#) on page 322
 - [":COUNTER:TOTALize:GATE:SOURce"](#) on page 323

12 :DEMO Commands

When the education kit is licensed (Option EDU), you can output demonstration signals on the oscilloscope's Demo 1 and Demo 2 terminals. See "[Introduction to :DEMO Commands](#)" on page 325.

Table 94 :DEMO Commands Summary

Command	Query	Options and Query Returns
:DEMO:FUNCTION <signal> (see page 326)	:DEMO:FUNCTION? (see page 329)	<signal> ::= {SINusoid NOISy PHASe RINGing SINGle AM CLK GLITCh BURSt MSO RUNT TRANSition RFBurst SHOLd LFSine FMBurst ETE CAN LIN UART I2C SPI I2S CANLin ARINc FLEXray MIL MIL2 USB NMONotonic}
:DEMO:FUNCTION:PHASE: PHASE <angle> (see page 330)	:DEMO:FUNCTION:PHASE: PHASE? (see page 330)	<angle> ::= angle in degrees from 0 to 360 in NR3 format
:DEMO:OUTPut {{0 OFF} {1 ON}} (see page 331)	:DEMO:OUTPut? (see page 331)	{0 1}

Introduction to :DEMO Commands The :DEMO subsystem provides commands to output demonstration signals on the oscilloscope's Demo 1 and Demo 2 terminals.

Reporting the Setup

Use :DEMO? to query setup information for the DEMO subsystem.

Return Format

The following is a sample response from the :DEMO? query. In this case, the query was issued following the *RST command.

```
:DEMO:FUNC SIN;OUTP 0
```

:DEMO:FUNCTION

N (see [page 1384](#))

Command Syntax :DEMO:FUNCTION <signal>

```
<signal> ::= {SINusoid | NOISy | PHASe | RINGing | SINGLE | AM | CLK
             | GLITCh | BURSt | MSO | RUNT | TRANsition | RFBurst
             | SHOLd | LFSine | FMBurst | ETE | CAN | LIN | UART
             | I2C | SPI | I2S | CANLin | ARINc | FLEXray | MIL
             | MIL2 | NMONotonic | DCMotor | HARMonics | COUPLing
             | CFD | SENT | KEYSight}
```

The :DEMO:FUNCTION command selects the type of demo signal:

Demo Signal Function	Demo 1 Terminal	Demo 2 Terminal
SINusoid	5 MHz sine wave @ ~ 6 Vpp, 0 V offset	Off
NOISy	1 kHz sine wave @ ~ 2.4 Vpp, 0.0 V offset, with ~ 0.5 Vpp of random noise added	Off
PHASe	1 kHz sine wave @ 2.4 Vpp, 0.0 V offset	1 kHz sine wave @ 2.4 Vpp, 0.0 V offset , phase shifted by the amount entered using the ":DEMO:FUNCTION:PHASe:PHASe" on page 330 command
RINGing	500 kHz digital pulse @ ~ 3 Vpp, 1.5 V offset, and ~500 ns pulse width with ringing	Off
SINGLE	~500 ns wide digital pulse with ringing @ ~ 3 Vpp, 1.5 V offset Press the front panel Set Off Single-Shot softkey to cause the selected single-shot signal to be output.	Off
AM	26 kHz sine wave, ~ 7 Vpp, 0 V offset	Amplitude modulated signal, ~ 3 Vpp, 0 V offset, with ~13 MHz carrier and sine envelope
CLK	3.6 MHz clock @ ~2 Vpp, 1 V offset, with infrequent glitch (1 glitch per 1,000,000 clocks)	Off
GLITCh	Burst of 6 digital pulses (plus infrequent glitch) that occurs once every 80 μ s @ ~3.6 Vpp, ~1.8 V offset	Off

Demo Signal Function	Demo 1 Terminal	Demo 2 Terminal
BURSt	Burst of digital pulses that occur every 50 μ s @ ~ 3.6 Vpp, ~1.5 V offset	Off
MSO	3.1 kHz stair-step sine wave output of DAC @ ~1.5 Vpp, 0.75 V offset DAC input signals are internally routed to digital channels D0 through D7	~3.1 kHz sine wave filtered from DAC output @ ~ 600 mVpp, 300 mV offset
RUNT	Digital pulse train with positive and negative runt pulses @ ~ 3.5 Vpp, 1.75 V offset	Off
TRANSition	Digital pulse train with two different edge speeds @ ~ 3.5 Vpp, 1.75 V offset	Off
RFBurst	5-cycle burst of a 10 MHz amplitude modulated sine wave @ ~ 2.6 Vpp, 0 V offset occurring once every 4 ms	Off
SHOLd	6.25 MHz digital clock @ ~ 3.5 Vpp, 1.75 V offset	Data signal @ ~3.5 Vpp, 1.75 V offset
LFSine	30 Hz sine wave @ ~2.7 Vpp, 0 V offset, with very narrow glitch near each positive peak	Off
FMBurst	FM burst, modulated from ~100 kHz to ~1 MHz, ~5.0 Vpp, ~600 mV offset.	Off
ETE	100 kHz pulse, 400 ns wide @ ~3.3 Vpp, 1.65 V offset	600 ns analog burst (@ ~3.3 Vpp, 0.7 V offset) followed by 3.6 μ s digital burst @ ~3.3 Vpp, 1.65 V offset) at a 100 kHz repetitive rate
CAN	CAN_L, 125 kbps dominant-low, ~2.8 Vpp, ~1.4 V offset	Off
LIN	LIN, 19.2 kbs, ~2.8 Vpp, ~1.4 V offset	Off
UART	Receive data (RX) with odd parity, 19.2 kbps, 8-bit words, LSB out 1st, low idle @ ~2.8 Vpp, 1.4 V offset	Transmit data (TX) with odd parity, 19.2 kbps, 8-bit words, LSB out 1st, low idle @ ~ 2.8 Vpp, 1.4 V offset
I2C	I2C serial clock signal (SCL) @ ~2.8 Vpp, 1.4 V offset	I2C serial data signal (SDA) @ ~ 2.8 Vpp, 1.4 V offset

Demo Signal Function	Demo 1 Terminal	Demo 2 Terminal
SPI	Off Signals are internally routed to digital channels D6 through D9: <ul style="list-style-type: none"> ▪ D9 – MOSI, TTL level, with MSB out 1st (internally routed to digital input). ▪ D8 – MISO, TTL level, with MSB out 1st (internally routed to digital input). ▪ D7 – CLK, TTL level (internally routed to digital input). ▪ D6 – ~CS, low-enable, TTL level (internally routed to digital input). 	Off
I2S	Off Signals are internally routed to digital channels D7 through D9: <ul style="list-style-type: none"> ▪ D9 – SDATA, TTL level, with "standard" alignment (internally routed to digital input). ▪ D8 – SCLK, TTL level, (internally routed to digital input). ▪ D7 – WS, TTL level, low for left channel, high for right channel (internally routed to digital input) 	Off
CANLin	CAN_L, 250 kbps dominant-low, ~2.8 Vpp, ~1.4 V offset	LIN, 19.2 kbps, ~2.8 Vpp, ~1.4 V offset
ARINc	ARINC 429, 100 kbps, ~5 Vpp, ~0 V offset.	Off
FLEXray	FlexRay @ 10 Mbps, ~2.8 Vpp, ~0 V offset	Off
MIL	MIL-STD-1553 RT to RT transfer, received ~1.3 Vpp, transmitted ~4.8 Vpp, 0 V offset	Off
MIL2	MIL-STD-1553 RT to RT transfer, received ~1.3 Vpp, transmitted ~4.8 Vpp, 0 V offset	MIL-STD-1553 RT to BC transfer, received ~1.3 Vpp, transmitted ~4.8 Vpp, 0 V offset
NMONotonic	Digital pulse train with infrequent non-monotonic rising edges @ ~2.85 Vpp, 1.42 V offset	Off
DCMotor	Output of DAC controlling a DC motor: 800 mV pulse, 1 μ s wide, every 10 μ s, runt pulse every 100 ms.	Off

Demo Signal Function	Demo 1 Terminal	Demo 2 Terminal
HARMonics	1 kHz sine wave @ ~3.5 Vpp, 0.0 V offset, with a ~2 kHz sine wave coupled in	Off
COUPling	1 kHz square wave @ ~1 Vpp, 0.0 V offset, with a ~90 kHz sine wave with ~180 mVpp riding on top	Off
CFD	CAN FD, ~2.4 Vpp, ~-1.2 V offset, 500 kb/s standard baud rate (sample point at 80%), 10 Mb/s FD baud rate (sample point at 50%)	Off
SENT	SENT, ~2.7 Vpp, ~1.35 V offset, 3 μ s clock period, 6 nibbles in a Fast Channel Message, Slow Channel Messages in enhanced format, idle state high, with pause pulse	Off
KEYSight	Series of positive and negative pulses, 125 μ s wide, amplitude modulated, ~2.6 Vpp, ~0 V offset	Off

Query Syntax :DEMO:FUNCTION?

The :DEMO:FUNCTION? query returns the currently selected demo signal type.

Return Format <signal><NL>

```
<signal> ::= {SIN | NOIS | PHAS | RING | SING | AM | CLK | GLIT
| BURS | MSO | RUNT | TRAN | RFB | SHOL | LFS | FMB
| ETE | CAN | LIN | UART | I2C | SPI | I2S | CANL
| ARIN | FLEX | MIL | MIL2 | NMON | DCM | HARM
| COUP | CFD | SENT | KEYS}
```

See Also · ["Introduction to :DEMO Commands"](#) on page 325

:DEMO:FUNCTION:PHASe:PHASe

N (see [page 1384](#))

Command Syntax :DEMO:FUNCTION:PHASe:PHASe <angle>

<angle> ::= angle in degrees from 0 to 360 in NR3 format

For the phase shifted sine demo signals, the :DEMO:FUNCTION:PHASe:PHASe command specifies the phase shift in the second sine waveform.

Query Syntax :DEMO:FUNCTION:PHASe:PHASe?

The :DEMO:FUNCTION:PHASe:PHASe? query returns the currently set phase shift.

Return Format <angle><NL>

<angle> ::= angle in degrees from 0 to 360 in NR3 format

- See Also**
- ["Introduction to :DEMO Commands"](#) on page 325
 - [":DEMO:FUNCTION"](#) on page 326

:DEMO:OUTPut

N (see [page 1384](#))

Command Syntax :DEMO:OUTPut <on_off>

<on_off> ::= {{1 | ON} | {0 | OFF}}

The :DEMO:OUTPut command specifies whether the demo signal output is ON (1) or OFF (0).

Query Syntax :DEMO:OUTPut?

The :DEMO:OUTPut? query returns the current state of the demo signal output setting.

Return Format <on_off><NL>

<on_off> ::= {1 | 0}

- See Also**
- ["Introduction to :DEMO Commands"](#) on page 325
 - [":DEMO:FUNCTION"](#) on page 326

13 :DIGital<d> Commands

Control all oscilloscope functions associated with individual digital channels. See "[Introduction to :DIGital<d> Commands](#)" on page 334.

Table 95 :DIGital<d> Commands Summary

Command	Query	Options and Query Returns
:DIGital<d>:DISPlay { {0 OFF} {1 ON} } (see page 335)	:DIGital<d>:DISPlay? (see page 335)	<d> ::= 0 to (# digital channels - 1) in NR1 format {0 1}
:DIGital<d>:LAbel <string> (see page 336)	:DIGital<d>:LAbel? (see page 336)	<d> ::= 0 to (# digital channels - 1) in NR1 format <string> ::= any series of 10 or less ASCII characters enclosed in quotation marks
:DIGital<d>:POSition <position> (see page 337)	:DIGital<d>:POSition? (see page 337)	<d> ::= 0 to (# digital channels - 1) in NR1 format <position> ::= 0-7 if display size = large, 0-15 if size = medium, 0-31 if size = small Returns -1 when there is no space to display the digital waveform.
:DIGital<d>:SIze <value> (see page 338)	:DIGital<d>:SIze? (see page 338)	<d> ::= 0 to (# digital channels - 1) in NR1 format <value> ::= {SMALl MEDium LARGe}
:DIGital<d>:THReshold <value>[suffix] (see page 339)	:DIGital<d>:THReshold? (see page 339)	<d> ::= 0 to (# digital channels - 1) in NR1 format <value> ::= {CMOS ECL TTL <user defined value>} <user defined value> ::= value in NR3 format from -8.00 to +8.00 [suffix] ::= {V mV uV}

**Introduction to
:DIGital<d>
Commands**

<d> ::= 0 to (# digital channels - 1) in NR1 format

The DIGital subsystem commands control the viewing, labeling, and positioning of digital channels. They also control threshold settings for groups of digital channels, or *Pods*.

NOTE

These commands are only valid for the MSO models.

Reporting the Setup

Use :DIGital<d>? to query setup information for the DIGital subsystem.

Return Format

The following is a sample response from the :DIGital0? query. In this case, the query was issued following a *RST command.

```
:DIG0:DISP 0;THR +1.40E+00;LAB 'D0';POS +0
```

:DIGital<d>:DISPlay

N (see [page 1384](#))

Command Syntax :DIGital<d>:DISPlay <display>

<d> ::= 0 to (# digital channels - 1) in NR1 format

<display> ::= {{1 | ON} | {0 | OFF}}

The :DIGital<d>:DISPlay command turns digital display on or off for the specified channel.

NOTE

This command is only valid for the MSO models.

Query Syntax :DIGital<d>:DISPlay?

The :DIGital<d>:DISPlay? query returns the current digital display setting for the specified channel.

Return Format <display><NL>

<display> ::= {0 | 1}

- See Also**
- ["Introduction to :DIGital<d> Commands"](#) on page 334
 - [":POD<n>:DISPlay"](#) on page 617
 - [":CHANnel<n>:DISPlay"](#) on page 294
 - [":VIEW"](#) on page 252
 - [":BLANK"](#) on page 224
 - [":STATus"](#) on page 249

:DIGital<d>:LABel

N (see [page 1384](#))

Command Syntax :DIGital<d>:LABel <string>

<d> ::= 0 to (# digital channels - 1) in NR1 format

<string> ::= any series of 10 or less characters as quoted ASCII string.

The :DIGital<d>:LABel command sets the channel label to the string that follows. Setting a label for a channel also adds the name to the label list in non-volatile memory (replacing the oldest label in the list).

NOTE

This command is only valid for the MSO models.

NOTE

Label strings are 10 characters or less, and may contain any commonly used ASCII characters. Labels with more than 10 characters are truncated to 10 characters.

Query Syntax :DIGital<d>:LABel?

The :DIGital<d>:LABel? query returns the name of the specified channel.

Return Format <label string><NL>

<label string> ::= any series of 10 or less characters as a quoted ASCII string.

- See Also**
- ["Introduction to :DIGital<d> Commands"](#) on page 334
 - [":CHANnel<n>:LABel"](#) on page 297
 - [":DISPlay:LABList"](#) on page 354
 - [":BUS<n>:LABel"](#) on page 274

:DIGital<d>:POSition

N (see [page 1384](#))

Command Syntax :DIGital<d>:POSition <position>
 <d> ::= 0 to (# digital channels - 1) in NR1 format
 <position> ::= integer in NR1 format.

Channel Size	Position	Top	Bottom
Large	0-7	7	0
Medium	0-15	15	0
Small	0-31	31	0

The :DIGital<d>:POSition command sets the position of the specified channel. Note that bottom positions might not be valid depending on whether digital buses, serial decode waveforms, or the zoomed time base are displayed.

NOTE

This command is only valid for the MSO models.

Query Syntax :DIGital<d>:POSition?

The :DIGital<d>:POSition? query returns the position of the specified channel.

If the returned value is "-1", this indicates there is no space to display the digital waveform (for example, when all serial lanes, digital buses, and the zoomed time base are displayed).

Return Format <position><NL>
 <position> ::= integer in NR1 format.

See Also • ["Introduction to :DIGital<d> Commands"](#) on page 334

:DIGital<d>:SIZE

N (see [page 1384](#))

Command Syntax :DIGital<d>:SIZE <value>

<d> ::= 0 to (# digital channels - 1) in NR1 format

<value> ::= {SMALl | MEDium | LARGe}

The :DIGital<d>:SIZE command specifies the size of digital channels on the display. Sizes are set for all digital channels. Therefore, if you set the size on digital channel 0 (for example), the same size is set on all other as well.

NOTE

This command is only valid for the MSO models.

Query Syntax :DIGital<d>:SIZE?

The :DIGital<d>:SIZE? query returns the size setting for the specified digital channels.

Return Format <size_value><NL>

<size_value> ::= {SMAL | MED | LARG}

- See Also**
- ["Introduction to :DIGital<d> Commands"](#) on page 334
 - [":POD<n>:SIZE"](#) on page 618
 - [":DIGital<d>:POSition"](#) on page 337

:DIGital<d>:THReshold

N (see [page 1384](#))

Command Syntax :DIGital<d>:THReshold <value>

<d> ::= 0 to (# digital channels - 1) in NR1 format

<value> ::= {CMOS | ECL | TTL | <user defined value>[<suffix>]}

<user defined value> ::= -8.00 to +8.00 in NR3 format

<suffix> ::= {V | mV | uV}

- TTL = 1.4V
- CMOS = 2.5V
- ECL = -1.3V

The :DIGital<d>:THReshold command sets the logic threshold value for all channels in the same *pod* as the specified channel. The threshold is used for triggering purposes and for displaying the digital data as high (above the threshold) or low (below the threshold).

NOTE

This command is only valid for the MSO models.

Query Syntax :DIGital<d>:THReshold?

The :DIGital<d>:THReshold? query returns the threshold value for the specified channel.

Return Format <value><NL>

<value> ::= threshold value in NR3 format

- See Also**
- ["Introduction to :DIGital<d> Commands"](#) on page 334
 - [":POD<n>:THReshold"](#) on page 619
 - [":TRIGger\[:EDGE\]:LEVel"](#) on page 1123

14 :DISPlay Commands

Control how waveforms, graticule, and text are displayed and written on the screen. See "[Introduction to :DISPlay Commands](#)" on page 342.

Table 96 :DISPlay Commands Summary

Command	Query	Options and Query Returns
:DISPlay:ANNotation<n> > {{0 OFF} {1 ON}} (see page 344)	:DISPlay:ANNotation<n> >? (see page 344)	{0 1} <n> ::= an integer from 1 to 4 in NR1 format.
:DISPlay:ANNotation<n> >:BACKground <mode> (see page 345)	:DISPlay:ANNotation<n> >:BACKground? (see page 345)	<mode> ::= {OPAQue INVerted TRANSPARENT} <n> ::= an integer from 1 to 4 in NR1 format.
:DISPlay:ANNotation<n> >:COLor <color> (see page 346)	:DISPlay:ANNotation<n> >:COLor? (see page 346)	<color> ::= {CH1 CH2 CH3 CH4 DIG MATH REF MARKer WHITE RED} <n> ::= an integer from 1 to 4 in NR1 format.
:DISPlay:ANNotation<n> >:TEXT <string> (see page 347)	:DISPlay:ANNotation<n> >:TEXT? (see page 347)	<string> ::= quoted ASCII string (up to 254 characters) <n> ::= an integer from 1 to 4 in NR1 format.
:DISPlay:ANNotation<n> >:X1Position <value> (see page 348)	:DISPlay:ANNotation<n> >:X1Position? (see page 348)	<value> ::= an integer from 0 to (800 - width of annotation) in NR1 format. <n> ::= an integer from 1 to 4 in NR1 format.
:DISPlay:ANNotation<n> >:Y1Position <value> (see page 349)	:DISPlay:ANNotation<n> >:Y1Position? (see page 349)	<value> ::= an integer from 0 to (480 - height of annotation) in NR1 format. <n> ::= an integer from 1 to 4 in NR1 format.
:DISPlay:CLEar (see page 350)	n/a	n/a

Table 96 :DISPlay Commands Summary (continued)

Command	Query	Options and Query Returns
n/a	:DISPlay:DATA? [<format>] [,] [<palette>] (see page 351)</format>	<format> ::= {BMP BMP8bit PNG} <palette> ::= {COLor GRAYscale} <display data> ::= data in IEEE 488.2 # format
:DISPlay:INTensity:WA Veform <value> (see page 352)	:DISPlay:INTensity:WA Veform? (see page 352)	<value> ::= an integer from 0 to 100 in NR1 format.
:DISPlay:LABel {{0 OFF} {1 ON}} (see page 353)	:DISPlay:LABel? (see page 353)	{0 1}
:DISPlay:LABList <binary block> (see page 354)	:DISPlay:LABList? (see page 354)	<binary block> ::= an ordered list of up to 75 labels, each 10 characters maximum, separated by newline characters
:DISPlay:MENU <menu> (see page 355)	n/a	<menu> ::= {MASK MEASure SEGmented LISTer POWer}
:DISPlay:SIDebar <sidebar> (see page 356)	n/a	<sidebar> ::= {SUMMARY CURSors MEASurements DVM NAVigate CONTrols EVENTs COUNTER}
:DISPlay:PERsistence <value> (see page 357)	:DISPlay:PERsistence? (see page 357)	<value> ::= {MINimum INFinite <time>} <time> ::= seconds in in NR3 format from 100E-3 to 60E0
:DISPlay:VECTors {1 ON} (see page 358)	:DISPlay:VECTors? (see page 358)	1

Introduction to :DISPlay Commands

The DISPlay subsystem is used to control the display storage and retrieval of waveform data, labels, and text. This subsystem allows the following actions:

- Clear the waveform area on the display.
- Turn vectors on or off.
- Set waveform persistence.
- Specify labels.
- Save and Recall display data.

Reporting the Setup

Use :DISPlay? to query the setup information for the DISPlay subsystem.

Return Format

The following is a sample response from the :DISPlay? query. In this case, the query was issued following a *RST command.

```
:DISP:LAB 0;VECT 1;PERS MIN
```

:DISPlay:ANNotation<n>

N (see [page 1384](#))

Command Syntax :DISPlay:ANNotation<n> <setting>

<setting> ::= {{1 | ON} | {0 | OFF}}

<n> ::= an integer from 1 to 10 in NR1 format.

The :DISPlay:ANNotation<n> command turns the annotation on and off. When on, the annotation appears in the upper left corner of the oscilloscope's display.

The annotation is useful for documentation purposes, to add notes before capturing screens.

Query Syntax :DISPlay:ANNotation<n>?

The :DISPlay:ANNotation<n>? query returns the annotation setting.

Return Format <value><NL>

<value> ::= {0 | 1}

- See Also**
- [":DISPlay:ANNotation<n>:TEXT"](#) on page 347
 - [":DISPlay:ANNotation<n>:COLor"](#) on page 346
 - [":DISPlay:ANNotation<n>:BACKground"](#) on page 345
 - [":DISPlay:ANNotation<n>:X1Position"](#) on page 348
 - [":DISPlay:ANNotation<n>:Y1Position"](#) on page 349
 - ["Introduction to :DISPlay Commands"](#) on page 342

:DISPlay:ANNotation<n>:BACKground

N (see [page 1384](#))

Command Syntax :DISPlay:ANNotation<n>:BACKground <mode>
 <mode> ::= {OPAQue | INVerted | TRANSPARENT}
 <n> ::= an integer from 1 to 10 in NR1 format.

The :DISPlay:ANNotation<n>:BACKground command specifies the background of the annotation:

- OPAQue – the annotation has a solid background.
- INVerted – the annotation's foreground and background colors are switched.
- TRANSPARENT – the annotation has a transparent background.

Query Syntax :DISPlay:ANNotation<n>:BACKground?

The :DISPlay:ANNotation<n>:BACKground? query returns the specified annotation background mode.

Return Format <mode><NL>
 <mode> ::= {OPAQ | INV | TRAN}

- See Also**
- [":DISPlay:ANNotation<n>"](#) on page 344
 - [":DISPlay:ANNotation<n>:TEXT"](#) on page 347
 - [":DISPlay:ANNotation<n>:COLor"](#) on page 346
 - [":DISPlay:ANNotation<n>:X1 Position"](#) on page 348
 - [":DISPlay:ANNotation<n>:Y1 Position"](#) on page 349
 - ["Introduction to :DISPlay Commands"](#) on page 342

:DISPlay:ANNotation<n>:COLor

N (see [page 1384](#))

Command Syntax :DISPlay:ANNotation<n>:COLor <color>

<color> ::= {CH1 | CH2 | CH3 | CH4 | DIG | MATH | REF | MARKer | WHITE
| RED}

<n> ::= an integer from 1 to 10 in NR1 format.

The :DISPlay:ANNotation<n>:COLor command specifies the annotation color. You can choose white, red, or colors that match analog channels, digital channels, math waveforms, reference waveforms, or markers.

Query Syntax :DISPlay:ANNotation<n>:COLor?

The :DISPlay:ANNotation<n>:COLor? query returns the specified annotation color.

Return Format <color><NL>

<color> ::= {CH1 | CH2 | CH3 | CH4 | DIG | MATH | REF | MARK | WHIT
| RED}

- See Also**
- [":DISPlay:ANNotation<n>"](#) on page 344
 - [":DISPlay:ANNotation<n>:TEXT"](#) on page 347
 - [":DISPlay:ANNotation<n>:BACKground"](#) on page 345
 - [":DISPlay:ANNotation<n>:X1Position"](#) on page 348
 - [":DISPlay:ANNotation<n>:Y1Position"](#) on page 349
 - ["Introduction to :DISPlay Commands"](#) on page 342

:DISPlay:ANNotation<n>:TEXT

N (see [page 1384](#))

Command Syntax :DISPlay:ANNotation<n>:TEXT <string>
 <string> ::= quoted ASCII string (up to 254 characters)
 <n> ::= an integer from 1 to 10 in NR1 format.

The :DISPlay:ANNotation<n>:TEXT command specifies the annotation string. The annotation string can contain as many characters as will fit in the Edit Annotation box on the oscilloscope's screen, up to 254 characters.

You can include a carriage return in the annotation string using the characters "\n". Note that this is not a new line character but the actual "\" (backslash) and "n" characters in the string. Carriage returns lessen the number of characters available for the annotation string.

Use :DISPlay:ANNotation<n>:TEXT "" to remotely clear the annotation text. (Two sets of quote marks without a space between them creates a NULL string.)

Query Syntax :DISPlay:ANNotation<n>:TEXT?

The :DISPlay:ANNotation<n>:TEXT? query returns the specified annotation text.

When carriage returns are present in the annotation text, they are returned as the actual carriage return character (ASCII 0x0D).

Return Format <string><NL>
 <string> ::= quoted ASCII string

- See Also**
- [":DISPlay:ANNotation<n>"](#) on page 344
 - [":DISPlay:ANNotation<n>:COLor"](#) on page 346
 - [":DISPlay:ANNotation<n>:BACKground"](#) on page 345
 - [":DISPlay:ANNotation<n>:X1Position"](#) on page 348
 - [":DISPlay:ANNotation<n>:Y1Position"](#) on page 349
 - ["Introduction to :DISPlay Commands"](#) on page 342

:DISPlay:ANNotation<n>:X1Position

N (see [page 1384](#))

Command Syntax :DISPlay:ANNotation<n>:X1Position <value>

<value> ::= an integer from 0 to (800 - width of annotation) in NR1 format.

<n> ::= an integer from 1 to 10 in NR1 format.

The :DISPlay:ANNotation<n>:X1Position command sets the annotation's horizontal X1 position.

Query Syntax :DISPlay:ANNotation<n>:X1Position?

The :DISPlay:ANNotation<n>:X1Position? query returns the annotation's horizontal X1 position.

Return Format <value><NL>

<value> ::= an integer from 0 to (800 - width of annotation) in NR1 format.

- See Also**
- [":DISPlay:ANNotation<n>:Y1Position"](#) on page 349
 - [":DISPlay:ANNotation<n>"](#) on page 344
 - [":DISPlay:ANNotation<n>:COLor"](#) on page 346
 - [":DISPlay:ANNotation<n>:BACKground"](#) on page 345
 - [":DISPlay:ANNotation<n>:TEXT"](#) on page 347

:DISPlay:ANNotation<n>:Y1Position

N (see [page 1384](#))

Command Syntax :DISPlay:ANNotation<n>:Y1Position <value>

<value> ::= an integer from 0 to (480 - height of annotation) in NR1 format.

<n> ::= an integer from 1 to 10 in NR1 format.

The :DISPlay:ANNotation<n>:Y1Position command sets the annotation's vertical Y1 position.

Query Syntax :DISPlay:ANNotation<n>:Y1Position?

The :DISPlay:ANNotation<n>:Y1Position? query returns the annotation's vertical Y1 position.

Return Format <value><NL>

<value> ::= an integer from 0 to (480 - height of annotation) in NR1 format.

- See Also**
- [":DISPlay:ANNotation<n>:X1Position"](#) on page 348
 - [":DISPlay:ANNotation<n>"](#) on page 344
 - [":DISPlay:ANNotation<n>:COLor"](#) on page 346
 - [":DISPlay:ANNotation<n>:BACKground"](#) on page 345
 - [":DISPlay:ANNotation<n>:TEXT"](#) on page 347

:DISPlay:CLEar

N (see [page 1384](#))

Command Syntax :DISPlay:CLEar

The :DISPlay:CLEar command clears the display and resets all associated measurements. If the oscilloscope is stopped, all currently displayed data is erased. If the oscilloscope is running, all of the data for active channels and functions is erased; however, new data is displayed on the next acquisition.

See Also • ["Introduction to :DISPlay Commands"](#) on page 342

:DISPlay:DATA

N (see [page 1384](#))

Query Syntax :DISPlay:DATA? [<format>] [, <palette>]

<format> ::= {BMP | BMP8bit | PNG}

<palette> ::= {COLor | GRAYscale}

The :DISPlay:DATA? query reads screen image data. You can choose 24-bit BMP, 8-bit BMP8bit, or 24-bit PNG formats in color or grayscale.

If no format or palette option is specified, the screen image is returned in BMP, COLor format.

Screen image data is returned in the IEEE-488.2 # binary block data format.

Return Format <display data><NL>

<display data> ::= binary block data in IEEE-488.2 # format.

- See Also**
- ["Introduction to :DISPlay Commands"](#) on page 342
 - [":HARDcopy:INKSaver"](#) on page 437
 - [":PRINT"](#) on page 245
 - ["*RCL \(Recall\)"](#) on page 201
 - ["*SAV \(Save\)"](#) on page 205
 - [":VIEW"](#) on page 252

Example Code

```
' IMAGE_TRANSFER - In this example, we will query for the image data
' with ":DISPlay:DATA?", read the data, and then save it to a file.
Dim byteData() As Byte
myScope.IO.Timeout = 15000
myScope.WriteString ":DISPlay:DATA? BMP, COLOR"
byteData = myScope.ReadIEEEBlock(BinaryType_UI1)
' Output display data to a file:
strPath = "c:\scope\data\screen.bmp"
' Remove file if it exists.
If Len(Dir(strPath)) Then
    Kill strPath
End If
Close #1 ' If #1 is open, close it.
Open strPath For Binary Access Write Lock Write As #1 ' Open file f
or output.
Put #1, , byteData ' Write data.
Close #1 ' Close file.
myScope.IO.Timeout = 5000
```

See complete example programs at: [Chapter 42](#), "Programming Examples," starting on page 1393

:DISPlay:INTensity:WAVEform

N (see [page 1384](#))

Command Syntax :DISPlay:INTensity:WAVEform <value>

<value> ::= an integer from 0 to 100 in NR1 format.

The :DISPlay:INTensity:WAVEform command sets the waveform intensity.

This is the same as adjusting the front panel **[Intensity]** knob.

Query Syntax :DISPlay:INTensity:WAVEform?

The :DISPlay:INTensity:WAVEform? query returns the waveform intensity setting.

Return Format <value><NL>

<value> ::= an integer from 0 to 100 in NR1 format.

See Also • ["Introduction to :DISPlay Commands"](#) on page 342

:DISPlay:LABel

N (see [page 1384](#))

Command Syntax :DISPlay:LABel <value>

<value> ::= {{1 | ON} | {0 | OFF}}

The :DISPlay:LABel command turns the analog and digital channel labels on and off.

Query Syntax :DISPlay:LABel?

The :DISPlay:LABel? query returns the display mode of the analog and digital labels.

Return Format <value><NL>

<value> ::= {0 | 1}

- See Also**
- ["Introduction to :DISPlay Commands"](#) on page 342
 - [":CHANnel<n>:LABel"](#) on page 297

Example Code

```
' DISP_LABEL
' - Turns label names ON or OFF on the analyzer display.
myScope.WriteString ":DISPlay:LABel ON" ' Turn on labels.
```

See complete example programs at: [Chapter 42](#), "Programming Examples," starting on page 1393

:DISPlay:LABList

N (see [page 1384](#))

Command Syntax :DISPlay:LABList <binary block data>

<binary block> ::= an ordered list of up to 75 labels, a maximum of 10 characters each, separated by newline characters.

The :DISPlay:LABList command adds labels to the label list. Labels are added in alphabetical order.

NOTE

Labels that begin with the same alphabetic base string followed by decimal digits are considered duplicate labels. Duplicate labels are not added to the label list. For example, if label "A0" is in the list and you try to add a new label called "A123456789", the new label is not added.

Query Syntax :DISPlay:LABList?

The :DISPlay:LABList? query returns the label list.

Return Format <binary block><NL>

<binary block> ::= an ordered list of up to 75 labels, a maximum of 10 characters each, separated by newline characters.

- See Also**
- ["Introduction to :DISPlay Commands"](#) on page 342
 - [":DISPlay:LABel"](#) on page 353
 - [":CHANnel<n>:LABel"](#) on page 297
 - [":DIGital<d>:LABel"](#) on page 336
 - [":BUS<n>:LABel"](#) on page 274

:DISPlay:MENU

N (see [page 1384](#))

Command Syntax :DISPlay:MENU <menu>

<menu> ::= {MASK | MEASure | SEGmented | LISTer | POWer}

The :DISPlay:MENU command changes the front panel softkey menu.

:DISPlay:SIDebar

N (see [page 1384](#))

Command Syntax :DISPlay:SIDebar <sidebar>

```
<sidebar> ::= {SUMMArY | CURSors | MEASurements | DVM | NAVigate  
             | CONTrols | EVENTs | COUNTer}
```

The :DISPlay:SIDebar command specifies the sidebar dialog to display on the screen.

:DISPlay:PERsistence

N (see [page 1384](#))

Command Syntax :DISPlay:PERsistence <value>

<value> ::= {MINimum | INFinite | <time>}

<time> ::= seconds in in NR3 format from 100E-3 to 60E0

The :DISPlay:PERsistence command specifies the persistence setting:

- MINimum – indicates zero persistence.
- INFinite – indicates infinite persistence.
- <time> – for variable persistence, that is, you can specify how long acquisitions remain on the screen.

Use the :DISPlay:CLEar command to erase points stored by persistence.

Query Syntax :DISPlay:PERsistence?

The :DISPlay:PERsistence? query returns the specified persistence value.

Return Format <value><NL>

<value> ::= {MIN | INF | <time>}

- See Also**
- ["Introduction to :DISPlay Commands"](#) on page 342
 - [":DISPlay:CLEar"](#) on page 350

:DISPlay:VECTors

N (see [page 1384](#))

Command Syntax :DISPlay:VECTors <vectors>
 <vectors> ::= {1 | ON}

Vector display is always ON in the 3000T X-Series oscilloscopes.

When vectors are turned on, the oscilloscope displays lines connecting sampled data points.

Query Syntax :DISPlay:VECTors?

The :DISPlay:VECTors? query returns the vectors setting.

Return Format <vectors><NL>
 <vectors> ::= 1

See Also • ["Introduction to :DISPlay Commands"](#) on page 342

15 :DVM Commands

When the optional DSOXDVM digital voltmeter analysis feature is licensed, these commands control the digital voltmeter (DVM) feature.

Table 97 :DVM Commands Summary

Command	Query	Options and Query Returns
:DVM:ARANge {{0 OFF} {1 ON}} (see page 360)	:DVM:ARANge? (see page 360)	{0 1}
n/a	:DVM:CURRent? (see page 361)	<dvm_value> ::= floating-point number in NR3 format
:DVM:ENABle {{0 OFF} {1 ON}} (see page 362)	:DVM:ENABle? (see page 362)	{0 1}
:DVM:MODE <mode> (see page 363)	:DVM:MODE? (see page 363)	<dvm_mode> ::= {ACRMs DC DCRMs}
:DVM:SOURce <source> (see page 364)	:DVM:SOURce? (see page 364)	<source> ::= {CHANnel<n>} <n> ::= 1-2 or 1-4 in NR1 format

:DVM:ARANge

N (see [page 1384](#))

Command Syntax :DVM:ARANge <setting>
 <setting> ::= {{OFF | 0} | {ON | 1}}

If the selected digital voltmeter (DVM) source channel is not used in oscilloscope triggering, the :DVM:ARANge command turns the digital voltmeter's Auto Range capability on or off.

- When on, the DVM channel's vertical scale, vertical (ground level) position, and trigger (threshold voltage) level (used for the counter frequency measurement) are automatically adjusted.

The Auto Range capability overrides attempted adjustments of the channel's vertical scale and position.

- When off, you can adjust the channel's vertical scale and position normally.

Query Syntax :DVM:ARANge?

The :DVM:ARANge? query returns a flag indicating whether the digital voltmeter's Auto Range capability is on or off.

Return Format <setting><NL>
 <setting> ::= {0 | 1}

- See Also**
- [":DVM:SOURce"](#) on page 364
 - [":DVM:ENABLE"](#) on page 362
 - [":DVM:MODE"](#) on page 363

:DVM:CURRent

N (see [page 1384](#))

Query Syntax :DVM:CURRent?

The :DVM:CURRent? query returns the displayed 3-digit DVM value based on the current mode.

Return Format <dvm_value><NL>

<dvm_value> ::= floating-point number in NR3 format

- See Also**
- [":DVM:SOURce"](#) on page 364
 - [":DVM:ENABLE"](#) on page 362
 - [":DVM:MODE"](#) on page 363

:DVM:ENABle

N (see [page 1384](#))

Command Syntax :DVM:ENABle <setting>

<setting> ::= {{OFF | 0} | {ON | 1}}

The :DVM:ENABle command turns the digital voltmeter (DVM) analysis feature on or off.

Query Syntax :DVM:ENABle?

The :DVM:ENABle? query returns a flag indicating whether the digital voltmeter (DVM) analysis feature is on or off.

Return Format <setting><NL>

<setting> ::= {0 | 1}

- See Also**
- [":DVM:SOURce"](#) on page 364
 - [":DVM:MODE"](#) on page 363
 - [":DVM:ARANge"](#) on page 360

:DVM:MODE

N (see [page 1384](#))

Command Syntax :DVM:MODE <dvm_mode>

<dvm_mode> ::= {ACRMs | DC | DCRMs}

The :DVM:MODE command sets the digital voltmeter (DVM) mode:

- ACRMs – displays the root-mean-square value of the acquired data, with the DC component removed.
- DC – displays the DC value of the acquired data.
- DCRMs – displays the root-mean-square value of the acquired data.

Query Syntax :DVM:MODE?

The :DVM:MODE? query returns the selected DVM mode.

Return Format <dvm_mode><NL>

<dvm_mode> ::= {ACRM | DC | DCRM}

- See Also**
- [":DVM:ENABLE"](#) on page 362
 - [":DVM:SOURce"](#) on page 364
 - [":DVM:ARANge"](#) on page 360
 - [":DVM:CURRent"](#) on page 361

:DVM:SOURce

N (see [page 1384](#))

Command Syntax :DVM:SOURce <source>

<source> ::= {CHANnel<n>}

<n> ::= 1-2 or 1-4 in NR1 format

The :DVM:SOURce command sets the select the analog channel on which digital voltmeter (DVM) measurements are made.

The selected channel does not have to be on (displaying a waveform) in order for DVM measurements to be made.

Query Syntax :DVM:SOURce?

The :DVM:SOURce? query returns the selected DVM input source.

Return Format <source><NL>

<source> ::= {CHAN<n>}

<n> ::= 1-2 or 1-4 in NR1 format

- See Also**
- [":DVM:ENABle"](#) on page 362
 - [":DVM:MODE"](#) on page 363
 - [":DVM:ARANge"](#) on page 360
 - [":DVM:CURRent"](#) on page 361

16 :EXternal Trigger Commands

Control the input characteristics of the external trigger input. See "[Introduction to :EXternal Trigger Commands](#)" on page 365.

Table 98 :EXternal Trigger Commands Summary

Command	Query	Options and Query Returns
:EXternal:BWLimit <bwlimit> (see page 366)	:EXternal:BWLimit? (see page 366)	<bwlimit> ::= {0 OFF}
:EXternal:PROBe <attenuation> (see page 367)	:EXternal:PROBe? (see page 367)	<attenuation> ::= probe attenuation ratio in NR3 format
:EXternal:RANGe <range> [<suffix>] (see page 368)	:EXternal:RANGe? (see page 368)	<range> ::= vertical full-scale range value in NR3 format <suffix> ::= {V mV}
:EXternal:UNITs <units> (see page 369)	:EXternal:UNITs? (see page 369)	<units> ::= {VOLT AMPere}

Introduction to :EXternal Trigger Commands

The EXternal trigger subsystem commands control the input characteristics of the external trigger input. The probe factor, impedance, input range, input protection state, units, and bandwidth limit settings may all be queried. Depending on the instrument type, some settings may be changeable.

Reporting the Setup

Use :EXternal? to query setup information for the EXternal subsystem.

Return Format

The following is a sample response from the :EXternal query. In this case, the query was issued following a *RST command.

```
:EXT:BWL 0;RANG +8.0E+00;UNIT VOLT;PROB +1.000E+00
```

:EXtErnal:BWLimit

C (see [page 1384](#))

Command Syntax :EXtErnal:BWLimit <bwlimit>

<bwlimit> ::= {0 | OFF}

The :EXtErnal:BWLimit command is provided for product compatibility. The only legal value is 0 or OFF. Use the :TRIGger:HFReject command to limit bandwidth on the external trigger input.

Query Syntax :EXtErnal:BWLimit?

The :EXtErnal:BWLimit? query returns the current setting of the low-pass filter (always 0).

Return Format <bwlimit><NL>

<bwlimit> ::= 0

- See Also**
- ["Introduction to :EXtErnal Trigger Commands"](#) on page 365
 - ["Introduction to :TRIGger Commands"](#) on page 1097
 - [":TRIGger:HFReject"](#) on page 1101

:EXternal:PROBe

C (see [page 1384](#))

Command Syntax :EXternal:PROBe <attenuation>

<attenuation> ::= probe attenuation ratio in NR3 format

The :EXternal:PROBe command specifies the probe attenuation factor for the external trigger. The probe attenuation factor may be 0.1 to 1000. This command does not change the actual input sensitivity of the oscilloscope. It changes the reference constants for scaling the display factors and for setting trigger levels.

If an AutoProbe probe is connected to the oscilloscope, the attenuation value cannot be changed from the sensed value. Attempting to set the oscilloscope to an attenuation value other than the sensed value produces an error.

Query Syntax :EXternal:PROBe?

The :EXternal:PROBe? query returns the current probe attenuation factor for the external trigger.

Return Format <attenuation><NL>

<attenuation> ::= probe attenuation ratio in NR3 format

- See Also**
- ["Introduction to :EXternal Trigger Commands"](#) on page 365
 - [":EXternal:RANGe"](#) on page 368
 - ["Introduction to :TRIGger Commands"](#) on page 1097
 - [":CHANnel<n>:PROBe"](#) on page 299

:EXtErnal:RANGe

C (see [page 1384](#))

Command Syntax :EXtErnal:RANGe <range>[<suffix>]

<range> ::= vertical full-scale range value in NR3 format

<suffix> ::= {V | mV}

The :EXtErnal:RANGe command is provided for product compatibility. When using 1:1 probe attenuation, the range can only be set to 8.0 V.

If the probe attenuation is changed, the range value is multiplied by the probe attenuation factor.

Query Syntax :EXtErnal:RANGe?

The :EXtErnal:RANGe? query returns the current full-scale range setting for the external trigger.

Return Format <range_argument><NL>

<range_argument> ::= external trigger range value in NR3 format

- See Also**
- ["Introduction to :EXtErnal Trigger Commands"](#) on page 365
 - [":EXtErnal:PROBe"](#) on page 367
 - ["Introduction to :TRIGger Commands"](#) on page 1097

:EXternal:UNITs

N (see [page 1384](#))

Command Syntax :EXternal:UNITs <units>

<units> ::= {VOLT | AMPere}

The :EXternal:UNITs command sets the measurement units for the probe connected to the external trigger input. Select VOLT for a voltage probe and select AMPere for a current probe. Measurement results, channel sensitivity, and trigger level will reflect the measurement units you select.

Query Syntax :EXternal:UNITs?

The :CHANnel<n>:UNITs? query returns the current units setting for the external trigger.

Return Format <units><NL>

<units> ::= {VOLT | AMP}

- See Also**
- ["Introduction to :EXternal Trigger Commands"](#) on page 365
 - ["Introduction to :TRIGger Commands"](#) on page 1097
 - [":EXternal:RANGe"](#) on page 368
 - [":EXternal:PROBe"](#) on page 367
 - [":CHANnel<n>:UNITs"](#) on page 310

17 :FFT Commands

Control the FFT function in the oscilloscope. See "[Introduction to :FFT Commands](#)" on page 372.

Table 99 :FFT Commands Summary

Command	Query	Options and Query Returns
:FFT:AVERAge:COUNT <count> (see page 373)	:FFT:AVERAge:COUNT? (see page 373)	<count> ::= an integer from 2 to 65536 in NR1 format.
:FFT:CENTer <frequency> (see page 374)	:FFT:CENTer? (see page 374)	<frequency> ::= the current center frequency in NR3 format. The range of legal values is from -25 GHz to 25 GHz.
:FFT:CLear (see page 375)	n/a	n/a
:FFT:DISPlay {{0 OFF} {1 ON}} (see page 376)	:FFT:DISPlay? (see page 376)	<s> ::= 1-6, in NR1 format. {0 1}
:FFT:DMODE <display_mode> (see page 377)	:FFT:DMODE? (see page 377)	<display_mode> ::= {NORMAL AVERAge MAXHold MINHold}
:FFT:FREQuency:START <frequency> (see page 379)	:FFT:FREQuency:START? (see page 379)	<frequency> ::= the start frequency in NR3 format.
:FFT:FREQuency:STOP <frequency> (see page 380)	:FFT:FREQuency:STOP? (see page 380)	<frequency> ::= the stop frequency in NR3 format.
:FFT:GATE <gating> (see page 381)	:FFT:GATE? (see page 381)	<gating> ::= {NONE ZOOM}
:FFT:OFFSet <offset> (see page 382)	:FFT:OFFSet? (see page 382)	<offset> ::= the value at center screen in NR3 format.
:FFT:RANGe <range> (see page 383)	:FFT:RANGe? (see page 383)	<range> ::= the full-scale vertical axis value in NR3 format.

Table 99 :FFT Commands Summary (continued)

Command	Query	Options and Query Returns
:FFT:REfERENCE <level> (see page 384)	:FFT:REfERENCE? (see page 384)	<level> ::= the current reference level in NR3 format.
:FFT:SCALE <scale value> [<suffix>] (see page 385)	:FFT:SCALE? (see page 385)	<scale_value> ::= integer in NR1 format. <suffix> ::= dB
:FFT:SOURce1 <source> (see page 386)	:FFT:SOURce1? (see page 386)	<source> ::= {CHANnel<n> FUNCTION<c> MATH<c>} <n> ::= 1 to (# analog channels) in NR1 format. <c> ::= {1 2}
:FFT:SPAN (see page 387)	:FFT:SPAN? (see page 387)	 ::= the current frequency span in NR3 format. Legal values are 1 Hz to 100 GHz.
:FFT:VTYPe <units> (see page 388)	:FFT:VTYPe? (see page 388)	<units> ::= {DECibel VRMS}
:FFT:WINDow <window> (see page 389)	:FFT:WINDow? (see page 389)	<window> ::= {RECTangular HANNing FLATtop BHARRis}

Introduction to :FFT Commands

The FFT subsystem controls the FFT function in the oscilloscope.

Reporting the Setup

Use :FFT? to query setup information for the FFT subsystem.

Return Format

The following is a sample response from the :FFT? query. In this case, the query was issued following a *RST command.

```
:FFT:DISP 0;SOUR1 CHAN1;RANG +160E+00;OFFS -60.0000E+00;SPAN
+100.0000E+03;CENT +50.000000E+03;WIND HANN;VTYP DEC;DMODE
NORM;AVER:COUN 8
```

:FFT:AVERAge:COUNT

N (see [page 1384](#))

Command Syntax :FFT:AVERAge:COUNT <count>

<count> ::= an integer from 2 to 65536 in NR1 format.

The :FFT:AVERAge:COUNT command sets the number of waveforms to be averaged together.

The number of averages can be set from 2 to 65536 in increments of powers of 2.

Increasing the number of averages will increase resolution and reduce noise.

Query Syntax :FFT:AVERAge:COUNT?

The :FFT:AVERAge:COUNT? query returns the number of waveforms to be averaged together.

Return Format <count><NL>

<count> ::= an integer from 2 to 65536 in NR1 format.

- See Also**
- [":FFT:CENTEr"](#) on page 374
 - [":FFT:CLEAr"](#) on page 375
 - [":FFT:DISPlay"](#) on page 376
 - [":FFT:DMODE"](#) on page 377
 - [":FFT:OFFSet"](#) on page 382
 - [":FFT:RANGe"](#) on page 383
 - [":FFT:REFerence"](#) on page 384
 - [":FFT:SCALe"](#) on page 385
 - [":FFT:SOURce1"](#) on page 386
 - [":FFT:SPAN"](#) on page 387
 - [":FFT:FREQuency:START"](#) on page 379
 - [":FFT:FREQuency:STOP"](#) on page 380
 - [":FFT:VTYPe"](#) on page 388
 - [":FFT:WINDow"](#) on page 389

:FFT:CENTer

N (see [page 1384](#))

Command Syntax :FFT:CENTer <frequency>

<frequency> ::= the current center frequency in NR3 format. The range of legal values is from -25 GHz to 25 GHz.

The :FFT:CENTer command sets the center frequency when FFT (Fast Fourier Transform) is selected.

Query Syntax :FFT:CENTer?

The :FFT:CENTer? query returns the current center frequency in Hertz.

Return Format <frequency><NL>

<frequency> ::= the current center frequency in NR3 format. The range of legal values is from -25 GHz to 25 GHz.

NOTE

After a *RST (Reset) or :AUToscale command, the values returned by the :FFT:CENTer? and :FFT:SPAN? queries depend on the current :TIMEbase:RANGe value. Once you change either the :FFT:CENTer or :FFT:SPAN value, they no longer track the :TIMEbase:RANGe value.

- See Also**
- [":FFT:AVERAge:COUNT"](#) on page 373
 - [":FFT:CENTer"](#) on page 374
 - [":FFT:DISPlay"](#) on page 376
 - [":FFT:DMODE"](#) on page 377
 - [":FFT:OFFSet"](#) on page 382
 - [":FFT:RANGe"](#) on page 383
 - [":FFT:REFerence"](#) on page 384
 - [":FFT:SCALE"](#) on page 385
 - [":FFT:SOURce1"](#) on page 386
 - [":FFT:SPAN"](#) on page 387
 - [":FFT:FREQuency:START"](#) on page 379
 - [":FFT:FREQuency:STOP"](#) on page 380
 - [":FFT:VTYPe"](#) on page 388
 - [":FFT:WINDow"](#) on page 389

:FFT:CLEar

N (see [page 1384](#))

Command Syntax :FFT:CLEar

When the FFT display mode is AVERage, MAXHold, or MINHold, the :FFT:CLEar command clears the number of evaluated waveforms.

- See Also**
- [":FFT:AVERage:COUNT"](#) on page 373
 - [":FFT:CENTer"](#) on page 374
 - [":FFT:DISPlay"](#) on page 376
 - [":FFT:DMODE"](#) on page 377
 - [":FFT:OFFSet"](#) on page 382
 - [":FFT:RANGe"](#) on page 383
 - [":FFT:REFerence"](#) on page 384
 - [":FFT:SCALe"](#) on page 385
 - [":FFT:SOURce1"](#) on page 386
 - [":FFT:SPAN"](#) on page 387
 - [":FFT:FREQuency:START"](#) on page 379
 - [":FFT:FREQuency:STOP"](#) on page 380
 - [":FFT:VTYPe"](#) on page 388
 - [":FFT:WINDow"](#) on page 389

:FFT:DISPlay

N (see [page 1384](#))

Command Syntax `:FFT:DISPlay {{0 | OFF} | {1 | ON}}`

The `:FFT:DISPlay` command turns the display of the FFT function on or off.

When ON is selected, the FFT function is calculated and displayed.

When OFF is selected, the FFT function is neither calculated nor displayed.

Query Syntax `:FFT:DISPlay?`

The `:FFT:DISPlay?` query returns whether the function display is on or off.

Return Format `<display><NL>`

`<display> ::= {0 | 1}`

- See Also**
- [":FFT:AVERAge:COUNT"](#) on page 373
 - [":FFT:CENTer"](#) on page 374
 - [":FFT:CLEar"](#) on page 375
 - [":FFT:DMODE"](#) on page 377
 - [":FFT:OFFSet"](#) on page 382
 - [":FFT:RANGe"](#) on page 383
 - [":FFT:REFerence"](#) on page 384
 - [":FFT:SCALE"](#) on page 385
 - [":FFT:SOURce1"](#) on page 386
 - [":FFT:SPAN"](#) on page 387
 - [":FFT:FREQuency:START"](#) on page 379
 - [":FFT:FREQuency:STOP"](#) on page 380
 - [":FFT:VTYPE"](#) on page 388
 - [":FFT:WINDow"](#) on page 389

:FFT:DMODE

N (see [page 1384](#))

Command Syntax :FFT:DMODE <display_mode>
 <display_mode> ::= {NORMAL | AVERage | MAXHold | MINHold}

The :FFT:DMODE command selects one of the FFT waveform display modes:

- **NORMAL** – this is the FFT waveform without any averaging or hold functions applied. This is how FFT math function waveforms are displayed.
- **AVERage** – the FFT waveform is averaged the selected number of times. Averages are calculated using a "decaying average" approximation, where:

$$\text{next_average} = \text{current_average} + (\text{new_data} - \text{current_average})/N$$

Where N starts at 1 for the first acquisition and increments for each following acquisition until it reaches the selected number of averages, where it holds.

- **MAXHold** – records the maximum vertical values found at each horizontal bucket across multiple analysis cycles and uses those values to build a waveform. This display mode is often referred to as Max Envelope.
- **MINHold** – records the minimum vertical values found at each horizontal bucket across multiple analysis cycles and uses those values to build a waveform. This display mode is often referred to as Min Envelope.

Query Syntax :FFT:DMODE?

The :FFT:DMODE? query returns the currently set FFT display mode.

Return Format <display_mode><NL>
 <display_mode> ::= {NORM | AVER | MAXH | MINH}

- See Also**
- [":FFT:AVERage:COUNT"](#) on page 373
 - [":FFT:CENTer"](#) on page 374
 - [":FFT:CLEar"](#) on page 375
 - [":FFT:DISPlay"](#) on page 376
 - [":FFT:OFFSet"](#) on page 382
 - [":FFT:RANGe"](#) on page 383
 - [":FFT:REFerence"](#) on page 384
 - [":FFT:SCALE"](#) on page 385
 - [":FFT:SOURce1"](#) on page 386
 - [":FFT:SPAN"](#) on page 387
 - [":FFT:FREQuency:START"](#) on page 379
 - [":FFT:FREQuency:STOP"](#) on page 380
 - [":FFT:VTYPE"](#) on page 388

- **":FFT:WINDow"** on page 389

:FFT:FREQuency:START

N (see [page 1384](#))

Command Syntax :FFT:FREQuency:START <frequency>

<frequency> ::= the start frequency in NR3 format.

The :FFT:FREQuency:START command sets the start frequency in the FFT (Fast Fourier Transform) math function's displayed range.

The FFT (Fast Fourier Transform) math function's displayed range can also be set with the :FFT:CENTEr and :FFT:SPAN commands.

Query Syntax :FFT:FREQuency:START?

The :FFT:FREQuency:START? query returns the current start frequency in Hertz.

Return Format <frequency><NL>

<frequency> ::= the start frequency in NR3 format.

- See Also**
- [":FFT:AVERAge:COUNT"](#) on page 373
 - [":FFT:CENTEr"](#) on page 374
 - [":FFT:CLEAr"](#) on page 375
 - [":FFT:DISPlay"](#) on page 376
 - [":FFT:DMODE"](#) on page 377
 - [":FFT:OFFSet"](#) on page 382
 - [":FFT:RANGe"](#) on page 383
 - [":FFT:REFerence"](#) on page 384
 - [":FFT:SCALE"](#) on page 385
 - [":FFT:SOURce1"](#) on page 386
 - [":FFT:SPAN"](#) on page 387
 - [":FFT:FREQuency:STOP"](#) on page 380
 - [":FFT:VTYPe"](#) on page 388
 - [":FFT:WINDow"](#) on page 389

:FFT:FREQuency:STOP

N (see [page 1384](#))

Command Syntax `:FFT:FREQuency:STOP <frequency>`
`<frequency> ::= the stop frequency in NR3 format.`

The `:FFT:FREQuency:STOP` command sets the stop frequency in the FFT (Fast Fourier Transform) math function's displayed range.

The FFT (Fast Fourier Transform) math function's displayed range can also be set with the `:FFT:CENTer` and `:FFT:SPAN` commands.

Query Syntax `:FFT:FREQuency:STOP?`

The `:FFT:FREQuency:STOP?` query returns returns the current stop frequency in Hertz.

Return Format `<frequency><NL>`
`<frequency> ::= the stop frequency in NR3 format.`

- See Also**
- [":FFT:AVERAge:COUNT"](#) on page 373
 - [":FFT:CENTer"](#) on page 374
 - [":FFT:CLEar"](#) on page 375
 - [":FFT:DISPlay"](#) on page 376
 - [":FFT:DMODE"](#) on page 377
 - [":FFT:OFFSet"](#) on page 382
 - [":FFT:RANGe"](#) on page 383
 - [":FFT:REFeRence"](#) on page 384
 - [":FFT:SCALe"](#) on page 385
 - [":FFT:SOURce1"](#) on page 386
 - [":FFT:SPAN"](#) on page 387
 - [":FFT:FREQuency:START"](#) on page 379
 - [":FFT:VTYPe"](#) on page 388
 - [":FFT:WINDow"](#) on page 389

:FFT:GATE

N (see [page 1384](#))

Command Syntax :FFT:GATE <gating>
 <gating> ::= {NONE | ZOOM}

The :FFT:GATE command specifies whether the FFT is performed on the Main time base window (NONE) or the ZOOM window when the zoomed time base is displayed.

Query Syntax :FFT:GATE?

The :FFT:GATE? query returns the gate setting.

Return Format <gating><NL>
 <gating> ::= {NONE | ZOOM}

- See Also**
- [":FFT:VTYPE"](#) on page 388
 - [":FFT:WINDOW"](#) on page 389
 - ["Introduction to :FFT Commands"](#) on page 372

:FFT:OFFSet

N (see [page 1384](#))

Command Syntax :FFT:OFFSet <offset>

<offset> ::= the value at center screen in NR3 format.

The :FFT:OFFSet command specifies the FFT vertical value represented at center screen.

If you set the offset to a value outside of the legal range, the offset value is automatically set to the nearest legal value.

NOTE

The :FFT:OFFSet command is equivalent to the :FFT:REFerence command.

Query Syntax :FFT:OFFSet?

The :FFT:OFFSet? query returns the current offset value for the FFT function.

Return Format <offset><NL>

<offset> ::= the value at center screen in NR3 format.

- See Also**
- [":FFT:AVERAge:COUNT"](#) on page 373
 - [":FFT:CENTer"](#) on page 374
 - [":FFT:CLEar"](#) on page 375
 - [":FFT:DISPlay"](#) on page 376
 - [":FFT:DMODE"](#) on page 377
 - [":FFT:RANGe"](#) on page 383
 - [":FFT:REFerence"](#) on page 384
 - [":FFT:SCALE"](#) on page 385
 - [":FFT:SOURce1"](#) on page 386
 - [":FFT:SPAN"](#) on page 387
 - [":FFT:FREQuency:START"](#) on page 379
 - [":FFT:FREQuency:STOP"](#) on page 380
 - [":FFT:VTYPE"](#) on page 388
 - [":FFT:WINDow"](#) on page 389

:FFT:RANGe

N (see [page 1384](#))

Command Syntax :FFT:RANGe <range>

<range> ::= the full-scale vertical axis value in NR3 format.

The :FFT:RANGe command defines the full-scale vertical axis for the FFT function.

Query Syntax :FFT:RANGe?

The :FFT:RANGe? query returns the current full-scale range value for the FFT function.

Return Format <range><NL>

<range> ::= the full-scale vertical axis value in NR3 format.

- See Also**
- [":FFT:AVERAge:COUNT"](#) on page 373
 - [":FFT:CENTer"](#) on page 374
 - [":FFT:CLEAr"](#) on page 375
 - [":FFT:DISPlay"](#) on page 376
 - [":FFT:DMODE"](#) on page 377
 - [":FFT:OFFSet"](#) on page 382
 - [":FFT:REFeRence"](#) on page 384
 - [":FFT:SCALe"](#) on page 385
 - [":FFT:SOURce1"](#) on page 386
 - [":FFT:SPAN"](#) on page 387
 - [":FFT:FREQuency:START"](#) on page 379
 - [":FFT:FREQuency:STOP"](#) on page 380
 - [":FFT:VTYPe"](#) on page 388
 - [":FFT:WINDow"](#) on page 389

:FFT:REFeRence

N (see [page 1384](#))

Command Syntax `:FFT:REFeRence <level>`

`<level>` ::= the current reference level in NR3 format.

The `:FFT:REFeRence` command specifies the FFT vertical value represented at center screen.

If you set the reference level to a value outside of the legal range, the level is automatically set to the nearest legal value.

NOTE

The `:FFT:REFeRence` command is equivalent to the `:FFT:OFFSet` command.

Query Syntax `:FFT:REFeRence?`

The `:FFT:REFeRence?` query returns the current reference level value for the FFT function.

Return Format `<level><NL>`

`<level>` ::= the current reference level in NR3 format.

- See Also**
- [":FFT:AVERage:COUNT"](#) on page 373
 - [":FFT:CENTer"](#) on page 374
 - [":FFT:CLEar"](#) on page 375
 - [":FFT:DISPlay"](#) on page 376
 - [":FFT:DMODE"](#) on page 377
 - [":FFT:OFFSet"](#) on page 382
 - [":FFT:RANGe"](#) on page 383
 - [":FFT:SCALE"](#) on page 385
 - [":FFT:SOURce1"](#) on page 386
 - [":FFT:SPAN"](#) on page 387
 - [":FFT:FREQuency:START"](#) on page 379
 - [":FFT:FREQuency:STOP"](#) on page 380
 - [":FFT:VTYPE"](#) on page 388
 - [":FFT:WINDow"](#) on page 389

:FFT:SCALE

N (see [page 1384](#))

Command Syntax :FFT:SCALE <scale_value>[<suffix>]

<scale_value> ::= floating-point value in NR3 format.

<suffix> ::= dB

The :FFT:SCALE command sets the vertical scale, or units per division, of the FFT function. Legal values for the scale depend on the selected function.

Query Syntax :FFT:SCALE?

The :FFT:SCALE? query returns the current scale value for the FFT function.

Return Format <scale_value><NL>

<scale_value> ::= floating-point value in NR3 format.

- See Also**
- [":FFT:AVERage:COUNT"](#) on page 373
 - [":FFT:CENTer"](#) on page 374
 - [":FFT:CLEar"](#) on page 375
 - [":FFT:DISPlay"](#) on page 376
 - [":FFT:DMODE"](#) on page 377
 - [":FFT:OFFSet"](#) on page 382
 - [":FFT:RANGe"](#) on page 383
 - [":FFT:REFerence"](#) on page 384
 - [":FFT:SOURce1"](#) on page 386
 - [":FFT:SPAN"](#) on page 387
 - [":FFT:FREQuency:START"](#) on page 379
 - [":FFT:FREQuency:STOP"](#) on page 380
 - [":FFT:VTYPE"](#) on page 388
 - [":FFT:WINDow"](#) on page 389

:FFT:SOURce1

N (see [page 1384](#))

Command Syntax :FFT:SOURce1 <offset>
 <source> ::= {CHANnel<n> | FUNction<c> | MATH<c>}
 <n> ::= 1 to (# analog channels) in NR1 format.
 <c> ::= {1 | 2}

The :FFT:SOURce1 command selects the source for the FFT function.

NOTE

Another shorthand notation for SOURce1 in this command/query (besides SOUR1) is SOUR.

Query Syntax :FFT:SOURce1?

The :FFT:SOURce1? query returns the current source1 for the FFT function.

Return Format <source><NL>
 <source> ::= {CHANnel<n> | FUNction<c> | MATH<c>}
 <n> ::= 1 to (# analog channels) in NR1 format.
 <c> ::= {1 | 2}

- See Also**
- [":FFT:AVERage:COUNT"](#) on page 373
 - [":FFT:CENter"](#) on page 374
 - [":FFT:CLEar"](#) on page 375
 - [":FFT:DISPlay"](#) on page 376
 - [":FFT:DMODE"](#) on page 377
 - [":FFT:OFFSet"](#) on page 382
 - [":FFT:RANGe"](#) on page 383
 - [":FFT:REFerence"](#) on page 384
 - [":FFT:SCALE"](#) on page 385
 - [":FFT:SPAN"](#) on page 387
 - [":FFT:FREQuency:START"](#) on page 379
 - [":FFT:FREQuency:STOP"](#) on page 380
 - [":FFT:VTYPe"](#) on page 388
 - [":FFT:WINDow"](#) on page 389

:FFT:SPAN

N (see [page 1384](#))

Command Syntax :FFT:SPAN

 ::= the current frequency span in NR3 format. Legal values are 1 Hz to 100 GHz.

If you set the frequency span to a value outside of the legal range, the step size is automatically set to the nearest legal value.

The :FFT:SPAN command sets the frequency span of the display (left graticule to right graticule) when FFT (Fast Fourier Transform) is selected.

Query Syntax :FFT:SPAN?

The :FFT:SPAN? query returns the current frequency span in Hertz.

NOTE

After a *RST (Reset) or :AUToscale command, the values returned by the :FFT:CENTer? and :FFT:SPAN? queries depend on the current :TIMEbase:RANGe value. Once you change either the :FFT:CENTer or :FFT:SPAN value, they no longer track the :TIMEbase:RANGe value.

Return Format <NL>

 ::= the current frequency span in NR3 format. Legal values are 1 Hz to 100 GHz.

- See Also**
- [":FFT:AVERAge:COUNT"](#) on page 373
 - [":FFT:CENTer"](#) on page 374
 - [":FFT:CLEar"](#) on page 375
 - [":FFT:DISPlay"](#) on page 376
 - [":FFT:DMODE"](#) on page 377
 - [":FFT:OFFSet"](#) on page 382
 - [":FFT:RANGe"](#) on page 383
 - [":FFT:REFerence"](#) on page 384
 - [":FFT:SCALE"](#) on page 385
 - [":FFT:SOURce1"](#) on page 386
 - [":FFT:FREQuency:START"](#) on page 379
 - [":FFT:FREQuency:STOP"](#) on page 380
 - [":FFT:VTYPe"](#) on page 388
 - [":FFT:WINDow"](#) on page 389

:FFT:VTYPE

N (see [page 1384](#))

Command Syntax :FFT:VTYPE <units>
 <units> ::= {DECibel | VRMS}

The :FFT:VTYPE command specifies FFT vertical units as DECibel or VRMS.

Query Syntax :FFT:VTYPE?

The :FFT:VTYPE? query returns the current FFT vertical units.

Return Format <units><NL>
 <units> ::= {DEC | VRMS}

- See Also**
- [":FFT:AVERAge:COUNT"](#) on page 373
 - [":FFT:CENTer"](#) on page 374
 - [":FFT:CLEar"](#) on page 375
 - [":FFT:DISPlay"](#) on page 376
 - [":FFT:DMODE"](#) on page 377
 - [":FFT:OFFSet"](#) on page 382
 - [":FFT:RANGe"](#) on page 383
 - [":FFT:REFerence"](#) on page 384
 - [":FFT:SCALe"](#) on page 385
 - [":FFT:SOURce1"](#) on page 386
 - [":FFT:SPAN"](#) on page 387
 - [":FFT:FREQuency:START"](#) on page 379
 - [":FFT:FREQuency:STOP"](#) on page 380
 - [":FFT:WINDow"](#) on page 389

:FFT:WINDow

N (see [page 1384](#))

Command Syntax :FFT:WINDow <window>

<window> ::= {RECTangular | HANNing | FLATtop | BHARris}

The :FFT:WINDow command allows the selection of four different windowing transforms or operations for the FFT (Fast Fourier Transform) function.

The FFT operation assumes that the time record repeats. Unless an integral number of sampled waveform cycles exist in the record, a discontinuity is created between the end of one record and the beginning of the next. This discontinuity introduces additional frequency components about the peaks into the spectrum. This is referred to as leakage. To minimize leakage, windows that approach zero smoothly at the start and end of the record are employed as filters to the FFTs. Each window is useful for certain classes of input signals.

- RECTangular – useful for transient signals, and signals where there are an integral number of cycles in the time record.
- HANNing – useful for frequency resolution and general purpose use. It is good for resolving two frequencies that are close together, or for making frequency measurements. This is the default window.
- FLATtop – best for making accurate amplitude measurements of frequency peaks.
- BHARris (Blackman-Harris) – reduces time resolution compared to the rectangular window, but it improves the capacity to detect smaller impulses due to lower secondary lobes (provides minimal spectral leakage).

Query Syntax :FFT:WINDow?

The :FFT:WINDow? query returns the value of the window selected for the FFT function.

Return Format <window><NL>

<window> ::= {RECT | HANN | FLAT | BHAR}

- See Also**
- [":FFT:AVERAge:COUNT"](#) on page 373
 - [":FFT:CENTer"](#) on page 374
 - [":FFT:CLEar"](#) on page 375
 - [":FFT:DISPlay"](#) on page 376
 - [":FFT:DMODE"](#) on page 377
 - [":FFT:OFFSet"](#) on page 382
 - [":FFT:RANGe"](#) on page 383
 - [":FFT:REFerence"](#) on page 384
 - [":FFT:SCALE"](#) on page 385

- **":FFT:SOURce1"** on page 386
- **":FFT:SPAN"** on page 387
- **":FFT:FREQuency:START"** on page 379
- **":FFT:FREQuency:STOP"** on page 380
- **":FFT:VTYPe"** on page 388

18 :FUNction<m> Commands

Control math functions in the oscilloscope. See "[Introduction to :FUNction<m> Commands](#)" on page 395.

Table 100: :FUNction<m> Commands Summary

Command	Query	Options and Query Returns
:FUNction<m>:AVERAge:COUNT <count> (see page 396)	:FUNction<m>:AVERAge:COUNT? (see page 396)	<count> ::= an integer from 2 to 65536 in NR1 format <m> ::= 1 to (# math functions) in NR1 format
:FUNction<m>:BUS:CLOCK <source> (see page 397)	:FUNction<m>:BUS:CLOCK? (see page 397)	<source> ::= {CHANnel<n> DIGital<d>} <n> ::= 1 to (# analog channels) in NR1 format <d> ::= 0 to (# digital channels - 1) in NR1 format <m> ::= 1 to (# math functions) in NR1 format
:FUNction<m>:BUS:SLOPE <slope> (see page 398)	:FUNction<m>:BUS:SLOPE? (see page 398)	<slope> ::= {NEGative POSitive EITHer} <m> ::= 1 to (# math functions) in NR1 format
:FUNction<m>:BUS:YINCRement <value> (see page 399)	:FUNction<m>:BUS:YINCRement? (see page 399)	<value> ::= value per bus code, in NR3 format <m> ::= 1 to (# math functions) in NR1 format
:FUNction<m>:BUS:YORigin <value> (see page 400)	:FUNction<m>:BUS:YORigin? (see page 400)	<value> ::= value at bus code = 0, in NR3 format <m> ::= 1 to (# math functions) in NR1 format
:FUNction<m>:BUS:YUNits <units> (see page 401)	:FUNction<m>:BUS:YUNits? (see page 401)	<units> ::= {VOLT AMPere NONE} <m> ::= 1 to (# math functions) in NR1 format

Table 100: :FUNCTION<m> Commands Summary (continued)

Command	Query	Options and Query Returns
:FUNCTION<m>:CLEar (see page 402)	n/a	n/a
:FUNCTION<m>:DISPlay {{0 OFF} {1 ON}} (see page 403)	:FUNCTION<m>:DISPlay? (see page 403)	{0 1} <m> ::= 1 to (# math functions) in NR1 format
:FUNCTION<m>[:FFT]:CENTer <frequency> (see page 404)	:FUNCTION<m>[:FFT]:CENTer? (see page 404)	<frequency> ::= the current center frequency in NR3 format. The range of legal values is from -25 GHz to 25 GHz. <m> ::= 1 to (# math functions) in NR1 format
:FUNCTION<m>[:FFT]:FREQuency:START <frequency> (see page 405)	:FUNCTION<m>[:FFT]:FREQuency:START? (see page 405)	<frequency> ::= the start frequency in NR3 format. <m> ::= 1 to (# math functions) in NR1 format
:FUNCTION<m>[:FFT]:FREQuency:STOP <frequency> (see page 406)	:FUNCTION<m>[:FFT]:FREQuency:STOP? (see page 406)	<frequency> ::= the stop frequency in NR3 format. <m> ::= 1 to (# math functions) in NR1 format
:FUNCTION<m>[:FFT]:GATE <gating> (see page 407)	:FUNCTION<m>[:FFT]:GATE? (see page 407)	<gating> ::= {NONE ZOOM} <m> ::= 1-4 in NR1 format
:FUNCTION<m>[:FFT]:PHASe:REFeRence <ref_point> (see page 408)	:FUNCTION<m>[:FFT]:PHASe:REFeRence? (see page 408)	<ref_point> ::= {TRIGger DISPlay} <m> ::= 1-4 in NR1 format
:FUNCTION<m>[:FFT]:SPAN (see page 409)	:FUNCTION<m>[:FFT]:SPAN? (see page 409)	 ::= the current frequency span in NR3 format. Legal values are 1 Hz to 100 GHz. <m> ::= 1 to (# math functions) in NR1 format
:FUNCTION<m>[:FFT]:VTYPe <units> (see page 410)	:FUNCTION<m>[:FFT]:VTYPe? (see page 410)	<units> ::= {DECibel VRMS} for the FFT (magnitude) operation <units> ::= {DEGREes RADis} for the FFTPhase operation <m> ::= 1 to (# math functions) in NR1 format
:FUNCTION<m>[:FFT]:WI NDow <window> (see page 411)	:FUNCTION<m>[:FFT]:WI NDow? (see page 411)	<window> ::= {RECTangular HANNing FLATtop BHARRis} <m> ::= 1 to (# math functions) in NR1 format

Table 100:FUNCTION<m> Commands Summary (continued)

Command	Query	Options and Query Returns
:FUNCTION<m>:FREQuency:HIGHpass <3dB_freq> (see page 412)	:FUNCTION<m>:FREQuency:HIGHpass? (see page 412)	<3dB_freq> ::= 3dB cutoff frequency value in NR3 format <m> ::= 1 to (# math functions) in NR1 format
:FUNCTION<m>:FREQuency:LOWPass <3dB_freq> (see page 413)	:FUNCTION<m>:FREQuency:LOWPass? (see page 413)	<3dB_freq> ::= 3dB cutoff frequency value in NR3 format <m> ::= 1 to (# math functions) in NR1 format
:FUNCTION<m>:INTEgrate:IOFFset <input_offset> (see page 414)	:FUNCTION<m>:INTEgrate:IOFFset? (see page 414)	<input_offset> ::= DC offset correction in NR3 format. <m> ::= 1 to (# math functions) in NR1 format
:FUNCTION<m>:LINear:GAIN <value> (see page 415)	:FUNCTION<m>:LINear:GAIN? (see page 415)	<value> ::= 'A' in Ax + B, value in NR3 format <m> ::= 1 to (# math functions) in NR1 format
:FUNCTION<m>:LINear:OFFSet <value> (see page 416)	:FUNCTION<m>:LINear:OFFSet? (see page 416)	<value> ::= 'B' in Ax + B, value in NR3 format <m> ::= 1 to (# math functions) in NR1 format
:FUNCTION<m>:OFFSet <offset> (see page 417)	:FUNCTION<m>:OFFSet? (see page 417)	<offset> ::= the value at center screen in NR3 format. The range of legal values is +/-10 times the current sensitivity of the selected function. <m> ::= 1 to (# math functions) in NR1 format
:FUNCTION<m>:OPERation <operation> (see page 418)	:FUNCTION<m>:OPERation? (see page 420)	<operation> ::= {ADD SUBTract MULTiply DIVide INTEgrate DIFF FFT FFTPhase SQRT MAGNify ABSolute SQUare LN LOG EXP TEN LOWPass HIGHpass AVERage LINear MAXimum MINimum PEAK MAXHold MINHold TREND BTIMing BSTate} <m> ::= 1 to (# math functions) in NR1 format

Table 100: FUNCTION<m> Commands Summary (continued)

Command	Query	Options and Query Returns
:FUNCTION<m>:RANGe <range> (see page 422)	:FUNCTION<m>:RANGe? (see page 422)	<range> ::= the full-scale vertical axis value in NR3 format. The range for ADD, SUBT, MULT is 8E-6 to 800E+3. The range for the INTEGRate function is 8E-9 to 400E+3. The range for the DIFF function is 80E-3 to 8.0E12 (depends on current sweep speed). The range for the FFT function is 8 to 800 dBV. <m> ::= 1 to (# math functions) in NR1 format
:FUNCTION<m>:REFerenc e <level> (see page 423)	:FUNCTION<m>:REFerenc e? (see page 423)	<level> ::= the value at center screen in NR3 format. The range of legal values is +/-10 times the current sensitivity of the selected function. <m> ::= 1 to (# math functions) in NR1 format
:FUNCTION<m>:SCALe <scale value>[<suffix>] (see page 424)	:FUNCTION<m>:SCALe? (see page 424)	<scale value> ::= integer in NR1 format <suffix> ::= {V dB} <m> ::= 1 to (# math functions) in NR1 format
:FUNCTION<m>:SMOoth:P OINTs <points> (see page 425)	:FUNCTION<m>:SMOoth:P OINTs? (see page 425)	<points> ::= odd integer in NR1 format
:FUNCTION<m>:SOURcel <source> (see page 426)	:FUNCTION<m>:SOURcel? (see page 426)	<source> ::= {CHANnel<n> FUNCTION<c> MATH<c> WMEMory<r> BUS} <n> ::= 1 to (# analog channels) in NR1 format <c> ::= {1}, must be lower than <m> <r> ::= 1 to (# ref waveforms) in NR1 format ::= {1 2} <m> ::= 1 to (# math functions) in NR1 format

Table 100: :FUNCTION<m> Commands Summary (continued)

Command	Query	Options and Query Returns
:FUNCTION<m>:SOURCE2 <source> (see page 428)	:FUNCTION<m>:SOURCE2? (see page 428)	<source> ::= {CHANNEL<n> WMEMORY<r> NONE} <n> ::= 1 to (# analog channels) in NR1 format <r> ::= 1 to (# ref waveforms) in NR1 format <m> ::= 1 to (# math functions) in NR1 format
:FUNCTION<m>:TREND:MEASUREMENT <type> (see page 429)	:FUNCTION<m>:TREND:MEASUREMENT? (see page 429)	<type> ::= {VAverage ACRMS VRATIO PERIOD FREQUENCY PWIDTh NWIDTh DUTYcycle RISetime FALLtime} <m> ::= 1 to (# math functions) in NR1 format

Introduction to :FUNCTION<m> Commands

The FUNCTION subsystem controls the math functions in the oscilloscope. Two math functions are available – the <m> in :FUNCTION<m> can be from 1 to 2. However, a dedicated FFT function is also available, see [Chapter 17](#), “:FFT Commands,” starting on page 371.

The math function operator, transform, filter, or visualization is selected using the :FUNCTION<m>:OPERATION command. Depending on the selected operation, there may be other commands for specifying options for that operation. See [":FUNCTION<m>:OPERATION"](#) on page 418.

The SOURCE1, DISPLAY, RANGE, and OFFSET (or REFERENCE) commands apply to any function.

Reporting the Setup

Use :FUNCTION<m>? to query setup information for the FUNCTION subsystem.

Return Format

The following is a sample response from the :FUNCTION1? query. In this case, the query was issued following a *RST command.

```
:FUNCTION1:OPER ADD;DISP 0;SOUR1 CHAN1;SOUR2 CHAN2;RANG +8.00E+00;OFFS  
+0.00E+00
```

:FUNCTION<m>:AVERAge:COUNT

N (see [page 1384](#))

Command Syntax :FUNCTION<m>:AVERAge:COUNT <count>

<count> ::= an integer from 2 to 65536 in NR1 format

<m> ::= 1 to (# math functions) in NR1 format

The :FUNCTION<m>:AVERAge:COUNT command sets the number of waveforms to be averaged together.

The number of averages can be set from 2 to 65536 in increments of powers of 2.

Increasing the number of averages will increase resolution and reduce noise.

Query Syntax :FUNCTION<m>:AVERAge:COUNT?

The :FUNCTION<m>:AVERAge:COUNT? query returns the number of waveforms to be averaged together.

Return Format <count><NL>

<count> ::= an integer from 2 to 65536 in NR1 format

See Also • [":FUNCTION<m>:OPERation"](#) on page 418

:FUNCTION<m>:BUS:CLOCK

N (see [page 1384](#))

Command Syntax :FUNCTION<m>:BUS:CLOCK <source>

<m> ::= 1 to (# math functions) in NR1 format

<source> ::= {DIGital<d>}

<d> ::= 0 to (# digital channels - 1) in NR1 format

The :FUNCTION<m>:BUS:CLOCK command selects the clock signal source for the Chart Logic Bus State operation.

Query Syntax :FUNCTION<m>:BUS:CLOCK?

The :FUNCTION<m>:BUS:CLOCK query returns the source selected for the clock signal.

Return Format <source><NL>

<source> ::= {DIGital<d>}

<d> ::= 0 to (# digital channels - 1) in NR1 format

See Also • [":FUNCTION<m>:OPERation"](#) on page 418

:FUNCTION<m>:BUS:SLOPe

N (see [page 1384](#))

Command Syntax :FUNCTION<m>:BUS:SLOPe <slope>

<m> ::= 1 to (# math functions) in NR1 format

<slope> ::= {NEGative | POSitive | EITHER}

The :FUNCTION<m>:BUS:SLOPe command specifies the clock signal edge for the Chart Logic Bus State operation.

Query Syntax :FUNCTION<m>:BUS:SLOPe?

The :FUNCTION<m>:BUS:SLOPe query returns the clock edge setting.

Return Format <slope><NL>

<slope> ::= {NEGative | POSitive | EITHER}

See Also • [":FUNCTION<m>:OPERation"](#) on page 418

:FUNCTION<m>:BUS:YINCrement

N (see [page 1384](#))

Command Syntax :FUNCTION<m>:BUS:YINCrement <value>

<m> ::= 1 to (# math functions) in NR1 format

<value> ::= value per bus code, in NR3 format

The :FUNCTION<m>:BUS:YINCrement command specifies the value associated with each increment in Chart Logic Bus data.

Query Syntax :FUNCTION<m>:BUS:YINCrement?

The :FUNCTION<m>:BUS:YINCrement query returns the value associated with each increment in Chart Logic Bus data.

Return Format <value><NL>

<value> ::= value per bus code, in NR3 format

See Also • [":FUNCTION<m>:OPERation"](#) on page 418

:FUNCTION<m>:BUS:YORigin

N (see [page 1384](#))

Command Syntax :FUNCTION<m>:BUS:YORigin <value>

<m> ::= 1 to (# math functions) in NR1 format

<value> ::= value at bus code = 0, in NR3 format

The :FUNCTION<m>:BUS:YORigin command specifies the value associated with Chart Logic Bus data equal to zero.

Query Syntax :FUNCTION<m>:BUS:YORigin?

The :FUNCTION<m>:BUS:YORigin query returns the value for associated with data equal to zero.

Return Format <value><NL>

<value> ::= value at bus code = 0, in NR3 format

See Also • [":FUNCTION<m>:OPERation"](#) on page 418

:FUNCTION<m>:BUS:YUNits

N (see [page 1384](#))

Command Syntax :FUNCTION<m>:BUS:YUNits <units>

<m> ::= 1 to (# math functions) in NR1 format

<units> ::= {VOLT | AMPere | NONE}

The :FUNCTION<m>:BUS:YUNits command specifies the vertical units for the Chart Logic Bus operations.

Query Syntax :FUNCTION<m>:BUS:YUNits?

The :FUNCTION<m>:BUS:YUNits query returns the Chart Logic Bus vertical units.

Return Format <units><NL>

<units> ::= {VOLT | AMP | NONE}

See Also • [":FUNCTION<m>:OPERation"](#) on page 418

:FUNCTION<m>:CLEAr

N (see [page 1384](#))

Command Syntax :FUNCTION<m>:CLEAr

When the :FUNCTION<m>:OPERation is AVERage, MAXHold, or MINHold, the :FUNCTION<m>:CLEAr command clears the number of evaluated waveforms.

See Also • [":FUNCTION<m>:AVERage:COUNt"](#) on page 396

:FUNCTION<m>:DISPlay

N (see [page 1384](#))

Command Syntax :FUNCTION<m>:DISPlay <display>

<m> ::= 1 to (# math functions) in NR1 format

<display> ::= {{1 | ON} | {0 | OFF}}

The :FUNCTION<m>:DISPlay command turns the display of the function on or off. When ON is selected, the function performs as specified using the other FUNCTION commands. When OFF is selected, function is neither calculated nor displayed.

Query Syntax :FUNCTION<m>:DISPlay?

The :FUNCTION<m>:DISPlay? query returns whether the function display is on or off.

Return Format <display><NL>

<display> ::= {1 | 0}

- See Also**
- ["Introduction to :FUNCTION<m> Commands"](#) on page 395
 - [":VIEW"](#) on page 252
 - [":BLANK"](#) on page 224
 - [":STATus"](#) on page 249

:FUNCTION<m>[:FFT]:CENTER

N (see [page 1384](#))

Command Syntax :FUNCTION<m>[:FFT]:CENTER <frequency>
 <m> ::= 1 to (# math functions) in NR1 format
 <frequency> ::= the current center frequency in NR3 format. The range of legal values is from -25 GHz to 25 GHz.

The :FUNCTION<m>[:FFT]:CENTER command sets the center frequency when FFT (Fast Fourier Transform) is selected.

Query Syntax :FUNCTION<m>[:FFT]:CENTER?

The :FUNCTION<m>[:FFT]:CENTER? query returns the current center frequency in Hertz.

Return Format <frequency><NL>

<frequency> ::= the current center frequency in NR3 format. The range of legal values is from -25 GHz to 25 GHz.

NOTE

After a *RST (Reset) or :AUToscale command, the values returned by the :FUNCTION<m>[:FFT]:CENTER? and :FUNCTION<m>:SPAN? queries depend on the current :TIMEbase:RANGe value. Once you change either the :FUNCTION<m>[:FFT]:CENTER or :FUNCTION<m>:SPAN value, they no longer track the :TIMEbase:RANGe value.

- See Also**
- ["Introduction to :FUNCTION<m> Commands"](#) on page 395
 - [":FUNCTION<m>\[:FFT\]:SPAN"](#) on page 409
 - [":TIMEbase:RANGe"](#) on page 1089
 - [":TIMEbase:SCALE"](#) on page 1092

:FUNCTION<m>[:FFT]:FREQUENCY:START

N (see [page 1384](#))

Command Syntax :FUNCTION<m>[:FFT]:FREQUENCY:START <frequency>

<m> ::= 1 to (# math functions) in NR1 format

<frequency> ::= the start frequency in NR3 format.

The :FUNCTION<m>[:FFT]:FREQUENCY:START command sets the start frequency in the FFT (Fast Fourier Transform) math function's displayed range.

The FFT (Fast Fourier Transform) math function's displayed range can also be set with the :FUNCTION<m>[:FFT]:CENTER and :FUNCTION<m>[:FFT]:SPAN commands.

Query Syntax :FUNCTION<m>[:FFT]:FREQUENCY:START?

The :FUNCTION<m>[:FFT]:FREQUENCY:START? query returns the current start frequency in Hertz.

Return Format <frequency><NL>

<frequency> ::= the start frequency in NR3 format.

- See Also**
- [":FUNCTION<m>\[:FFT\]:FREQUENCY:STOP"](#) on page 406
 - [":FUNCTION<m>\[:FFT\]:CENTER"](#) on page 404
 - [":FUNCTION<m>\[:FFT\]:SPAN"](#) on page 409

:FUNCTION<m>[:FFT]:FREQUENCY:STOP

N (see [page 1384](#))

Command Syntax :FUNCTION<m>[:FFT]:FREQUENCY:STOP <frequency>

<m> ::= 1 to (# math functions) in NR1 format

<frequency> ::= the stop frequency in NR3 format.

The :FUNCTION<m>[:FFT]:FREQUENCY:STOP command sets the stop frequency in the FFT (Fast Fourier Transform) math function's displayed range.

The FFT (Fast Fourier Transform) math function's displayed range can also be set with the :FUNCTION<m>[:FFT]:CENTER and :FUNCTION<m>[:FFT]:SPAN commands.

Query Syntax :FUNCTION<m>[:FFT]:FREQUENCY:STOP?

The :FUNCTION<m>[:FFT]:FREQUENCY:STOP? query returns returns the current stop frequency in Hertz.

Return Format <frequency><NL>

<frequency> ::= the stop frequency in NR3 format.

- See Also**
- [":FUNCTION<m>\[:FFT\]:FREQUENCY:START"](#) on page 405
 - [":FUNCTION<m>\[:FFT\]:CENTER"](#) on page 404
 - [":FUNCTION<m>\[:FFT\]:SPAN"](#) on page 409

:FUNCTION<m>[:FFT]:GATE

N (see [page 1384](#))

Command Syntax :FUNCTION<m>[:FFT]:GATE <gating>

<m> ::= 1-4 in NR1 format

<gating> ::= {NONE | ZOOM}

The :FUNCTION<m>[:FFT]:GATE command specifies whether the FFT is performed on the Main time base window (NONE) or the ZOOM window when the zoomed time base is displayed.

Query Syntax :FUNCTION<m>[:FFT]:GATE?

The :FUNCTION<m>[:FFT]:GATE? query returns the gate setting.

Return Format <gating><NL>

<gating> ::= {NONE | ZOOM}

- See Also**
- [":FUNCTION<m>\[:FFT\]:VTYPE"](#) on page 410
 - [":FUNCTION<m>\[:FFT\]:WINDOW"](#) on page 411
 - ["Introduction to :FUNCTION<m> Commands"](#) on page 395
 - [":FUNCTION<m>:OPERATION"](#) on page 418

:FUNCTION<m>[:FFT]:PHASe:REFeRence

N (see [page 1384](#))

Command Syntax :FUNCTION<m>[:FFT]:PHASe:REFeRence <ref_point>

<ref_point> ::= {TRIGger | DISPlay}

<m> ::= 1-4 in NR1 format

The :FUNCTION<m>[:FFT]:PHASe:REFeRence command sets the reference point for calculating the FFT Phase function to either the trigger point or beginning of the displayed waveform.

Query Syntax :FUNCTION<m>[:FFT]:PHASe:REFeRence?

The :FUNCTION<m>[:FFT]:PHASe:REFeRence? query returns the selected reference point.

Return Format <ref_point><NL>

<ref_point> ::= {TRIGger | DISPlay}

- See Also**
- [":FUNCTION<m>:OPERation"](#) on page 418
 - ["Introduction to :FUNCTION<m> Commands"](#) on page 395

:FUNCTION<m>[:FFT]:SPAN

N (see [page 1384](#))

Command Syntax :FUNCTION<m>[:FFT]:SPAN

<m> ::= 1 to (# math functions) in NR1 format

 ::= the current frequency span in NR3 format. Legal values are 1 Hz to 100 GHz.

If you set the frequency span to a value outside of the legal range, the step size is automatically set to the nearest legal value.

The :FUNCTION<m>[:FFT]:SPAN command sets the frequency span of the display (left graticule to right graticule) when FFT (Fast Fourier Transform) is selected.

Query Syntax :FUNCTION<m>[:FFT]:SPAN?

The :FUNCTION<m>[:FFT]:SPAN? query returns the current frequency span in Hertz.

NOTE

After a *RST (Reset) or :AUToscale command, the values returned by the :FUNCTION<m>[:FFT]:CENTER? and :FUNCTION<m>:SPAN? queries depend on the current :TIMEbase:RANGe value. Once you change either the :FUNCTION<m>[:FFT]:CENTER or :FUNCTION<m>:SPAN value, they no longer track the :TIMEbase:RANGe value.

Return Format <NL>

 ::= the current frequency span in NR3 format. Legal values are 1 Hz to 100 GHz.

- See Also**
- ["Introduction to :FUNCTION<m> Commands"](#) on page 395
 - [":FUNCTION<m>\[:FFT\]:CENTER"](#) on page 404
 - [":TIMEbase:RANGe"](#) on page 1089
 - [":TIMEbase:SCALE"](#) on page 1092

:FUNCTION<m>[:FFT]:VTYPE

N (see [page 1384](#))

Command Syntax :FUNCTION<m>[:FFT]:VTYPE <units>

<m> ::= 1 to (# math functions) in NR1 format

<units> ::= {DECibel | VRMS} for the FFT (magnitude) operation

<units> ::= {DEGREes | RADians} for the FFTPhase operation

The :FUNCTION<m>[:FFT]:VTYPE command specifies FFT vertical units.

Query Syntax :FUNCTION<m>[:FFT]:VTYPE?

The :FUNCTION<m>[:FFT]:VTYPE? query returns the current FFT vertical units.

Return Format <units><NL>

<units> ::= {DEC | VRMS} for the FFT (magnitude) operation

<units> ::= {DEGR | RAD} for the FFTPhase operation

- See Also**
- [":FUNCTION<m>\[:FFT\]:GATE"](#) on page 407
 - ["Introduction to :FUNCTION<m> Commands"](#) on page 395
 - [":FUNCTION<m>:OPERation"](#) on page 418

:FUNCTION<m>[:FFT]:WINDow

N (see [page 1384](#))

Command Syntax :FUNCTION<m>[:FFT]:WINDow <window>

<m> ::= 1 to (# math functions) in NR1 format

<window> ::= {RECTangular | HANNing | FLATtop | BHARris}

The :FUNCTION<m>[:FFT]:WINDow command allows the selection of four different windowing transforms or operations for the FFT (Fast Fourier Transform) function.

The FFT operation assumes that the time record repeats. Unless an integral number of sampled waveform cycles exist in the record, a discontinuity is created between the end of one record and the beginning of the next. This discontinuity introduces additional frequency components about the peaks into the spectrum. This is referred to as leakage. To minimize leakage, windows that approach zero smoothly at the start and end of the record are employed as filters to the FFTs. Each window is useful for certain classes of input signals.

- RECTangular – useful for transient signals, and signals where there are an integral number of cycles in the time record.
- HANNing – useful for frequency resolution and general purpose use. It is good for resolving two frequencies that are close together, or for making frequency measurements. This is the default window.
- FLATtop – best for making accurate amplitude measurements of frequency peaks.
- BHARris (Blackman-Harris) – reduces time resolution compared to the rectangular window, but it improves the capacity to detect smaller impulses due to lower secondary lobes (provides minimal spectral leakage).

Query Syntax :FUNCTION<m>[:FFT]:WINDow?

The :FUNCTION<m>[:FFT]:WINDow? query returns the value of the window selected for the FFT function.

Return Format <window><NL>

<window> ::= {RECT | HANN | FLAT | BHAR}

- See Also**
- [":FUNCTION<m>\[:FFT\]:GATE"](#) on page 407
 - ["Introduction to :FUNCTION<m> Commands"](#) on page 395

:FUNCTION<m>:FREQUENCY:HIGHpass

N (see [page 1384](#))

Command Syntax :FUNCTION<m>:FREQUENCY:HIGHpass <3dB_freq>

<m> ::= 1 to (# math functions) in NR1 format

<3dB_freq> ::= -3dB cutoff frequency value in NR3 format

The :FUNCTION<m>:FREQUENCY:HIGHpass command sets the high-pass filter's -3 dB cutoff frequency.

The high-pass filter is a single-pole high pass filter.

Query Syntax :FUNCTION<m>:FREQUENCY:HIGHpass?

The :FUNCTION<m>:FREQUENCY:HIGHpass query returns the high-pass filter's cutoff frequency.

Return Format <3dB_freq><NL>

<3dB_freq> ::= -3dB cutoff frequency value in NR3 format

See Also • [":FUNCTION<m>:OPERation"](#) on page 418

:FUNCTION<m>:FREQUENCY:LOWPass

N (see [page 1384](#))

Command Syntax :FUNCTION<m>:FREQUENCY:LOWPass <3dB_freq>

<m> ::= 1 to (# math functions) in NR1 format

<3dB_freq> ::= -3dB cutoff frequency value in NR3 format

The :FUNCTION<m>:FREQUENCY:LOWPass command sets the low-pass filter's -3 dB cutoff frequency.

The low-pass filter is a 4th order Bessel-Thompson filter.

Query Syntax :FUNCTION<m>:FREQUENCY:LOWPass?

The :FUNCTION<m>:FREQUENCY:LOWPass query returns the low-pass filter's cutoff frequency.

Return Format <3dB_freq><NL>

<3dB_freq> ::= -3dB cutoff frequency value in NR3 format

See Also • [":FUNCTION<m>:OPERation"](#) on page 418

:FUNCTION<m>:INTEgrate:IOFFset

N (see [page 1384](#))

Command Syntax :FUNCTION<m>:INTEgrate:IOFFset <input_offset>
 <m> ::= 1 to (# math functions) in NR1 format
 <input_offset> ::= DC offset correction in NR3 format.

The :FUNCTION<m>:INTEgrate:IOFFset command lets you enter a DC offset correction factor for the integrate math waveform input signal. This DC offset correction lets you level a "ramp"ed waveform.

Query Syntax :FUNCTION<m>:INTEgrate:IOFFset?

The :FUNCTION<m>:INTEgrate:IOFFset? query returns the current input offset value.

Return Format <input_offset><NL>
 <input_offset> ::= DC offset correction in NR3 format.

- See Also**
- ["Introduction to :FUNCTION<m> Commands"](#) on page 395
 - [":FUNCTION<m>:OPERation"](#) on page 418

:FUNCTION<m>:LINear:GAIN

N (see [page 1384](#))

Command Syntax :FUNCTION<m>:LINear:GAIN <value>

<m> ::= 1 to (# math functions) in NR1 format

<value> ::= 'A' in Ax + B, value in NR3 format

The :FUNCTION<m>:LINear:GAIN command specifies the 'A' value in the Ax + B operation.

Query Syntax :FUNCTION<m>:LINear:GAIN?

The :FUNCTION<m>:LINear:GAIN query returns the gain value.

Return Format <value><NL>

<value> ::= 'A' in Ax + B, value in NR3 format

See Also • [":FUNCTION<m>:OPERation"](#) on page 418

:FUNCTION<m>:LINear:OFFSet

N (see [page 1384](#))

Command Syntax :FUNCTION<m>:LINear:OFFSet <value>

<m> ::= 1 to (# math functions) in NR1 format

<value> ::= 'B' in Ax + B, value in NR3 format

The :FUNCTION<m>:LINear:OFFSet command specifies the 'B' value in the Ax + B operation.

Query Syntax :FUNCTION<m>:LINear:OFFSet?

The :FUNCTION<m>:LINear:OFFSet query returns the offset value.

Return Format <value><NL>

<value> ::= 'B' in Ax + B, value in NR3 format

See Also • [":FUNCTION<m>:OPERation"](#) on page 418

:FUNCTION<m>:OFFSet

N (see [page 1384](#))

Command Syntax :FUNCTION<m>:OFFSet <offset>

<m> ::= 1 to (# math functions) in NR1 format

<offset> ::= the value at center screen in NR3 format.

The :FUNCTION<m>:OFFSet command sets the voltage or vertical value represented at center screen for the selected function. The range of legal values is generally +/-10 times the current scale of the selected function, but will vary by function. If you set the offset to a value outside of the legal range, the offset value is automatically set to the nearest legal value.

NOTE

The :FUNCTION<m>:OFFSet command is equivalent to the :FUNCTION<m>:REFerence command.

Query Syntax :FUNCTION<m>:OFFSet?

The :FUNCTION<m>:OFFSet? query outputs the current offset value for the selected function.

Return Format <offset><NL>

<offset> ::= the value at center screen in NR3 format.

- See Also**
- ["Introduction to :FUNCTION<m> Commands"](#) on page 395
 - [":FUNCTION<m>:RANGe"](#) on page 422
 - [":FUNCTION<m>:REFerence"](#) on page 423
 - [":FUNCTION<m>:SCALE"](#) on page 424

:FUNCTION<m>:OPERation

N (see [page 1384](#))

Command Syntax :FUNCTION<m>:OPERation <operation>

<m> ::= 1 to (# math functions) in NR1 format

```
<operation> ::= {ADD | SUBTract | MULTiPLY | DIVide | DIFF | INTegrate
| FFT | FFTPhase | SQRT | MAGNify | ABSolute | SQUare | LN | LOG
| EXP | TEN | LOWPass | HIGHpass | AVERage | SMOoth | ENvelope
| LINear | MAXimum | MINimum | PEAK | MAXHold | MINHold | TREND
| BTIMing | BState}
```

The :FUNCTION<m>:OPERation command sets the desired waveform math operator, transform, filter or visualization:

- Operators:

- ADD – Source1 + source2.
- SUBTract – Source1 - source2.
- MULTiPLY – Source1 * source2.
- DIVide – Source1 / source2.

Operators perform their function on two analog channel sources.

- Transforms:

- DIFF – Differentiate
- INTegrate – The INTegrate:IOFFset command lets you specify a DC offset correction factor.
- FFT (magnitude) – Using the Fast Fourier Transform (FFT), this operation displays the magnitudes of the frequency content that makes up the source waveform. The FFT takes the digitized time record of the specified source and transforms it to the frequency domain.

The SPAN, CENTER, VTYPe, and WINDow commands are used for FFT functions. When FFT is selected, the horizontal cursors change from time to frequency (Hz), and the vertical cursors change from volts to decibels or V RMS.

- FFTPhase – Using the Fast Fourier Transform (FFT), this operation shows the phase relationships of the frequency content that makes up the source waveform. The FFT takes the digitized time record of the specified source and transforms it to the frequency domain.

The SPAN, CENTER, VTYPe, and WINDow commands are used for FFT functions. When FFTPhase is selected, the horizontal cursors change from time to frequency (Hz), and the vertical cursors change from volts to degrees or radians.

- LINear – $Ax + B$ – The LINear commands set the gain (A) and offset (B) values for this function.

- SQUare
- SQRT – Square root
- ABSolute – Absolute Value
- LOG – Common Logarithm
- LN – Natural Logarithm
- EXP – Exponential (e^x)
- TEN – Base 10 exponential (10^x)

Transforms operate on a single analog channel source or on lower math functions.

- Filters:
 - LOWPass – Low pass filter – The FREQuency:LOWPass command sets the -3 dB cutoff frequency.
 - HIGHpass – High pass filter – The FREQuency:HIGHPass command sets the -3 dB cutoff frequency.
 - AVERage – Averaged value – The AVERage:COUNT command specifies the number of averages.

Unlike acquisition averaging, the math averaging operator can be used to average the data on a single analog input channel or math function.

If acquisition averaging is also used, the analog input channel data is averaged and the math function averages it again. You can use both types of averaging to get a certain number of averages on all waveforms and an increased number of averages on a particular waveform.

Averages are calculated using a "decaying average" approximation, where:

$$\text{next_average} = \text{current_average} + (\text{new_data} - \text{current_average})/N$$

Where N starts at 1 for the first acquisition and increments for each following acquisition until it reaches the selected number of averages, where it holds.

- SMOoth – Smoothing – The resulting math waveform is the selected source with a normalized rectangular (boxcar) FIR filter applied.

The boxcar filter is a moving average of adjacent waveform points, where the number of adjacent points is specified by the SMOoth:POINts command. You can choose an odd number of points, from 3 to 999.

The smoothing operator limits the bandwidth of the source waveform. The smoothing operator can be used, for example, to smooth measurement trend waveforms.

- ENvelope – Envelope – The resulting math waveform is the amplitude envelope for an amplitude modulated (AM) input signal.

This function uses a Hilbert transform to get the real (in-phase, I) and imaginary (quadrature, Q) parts of the input signal and then performs a square root of the sum of the real and imaginary parts to get the demodulated amplitude envelope waveform.

Filters operate on a single analog channel source or on a lower math function.

- Visualizations:
 - MAGNify – Operates on a single analog channel source or on a lower math function.
 - MAXimum – This operator is like the MAXHold operator without the hold. The maximum vertical values found at each horizontal bucket are used to build a waveform.
 - MINimum – This operator is like the MINHold operator without the hold. The minimum vertical values found at each horizontal bucket are used to build a waveform.
 - PEAK – The PEAK operator is like the MAXimum operator minus the MINimum operator. At each horizontal bucket, the minimum vertical values found are subtracted from the maximum vertical values found to build a waveform.
 - MAXHold – Operates on a single analog channel source or on a lower math function. The Max Hold (or Max Envelope) operator records the maximum vertical values found at each horizontal bucket across multiple analysis cycles and uses those values to build a waveform.
 - MINHold – Operates on a single analog channel source or on a lower math function. The Min Hold (or Min Envelope) operator records the minimum vertical values found at each horizontal bucket across multiple analysis cycles and uses those values to build a waveform.
 - TREND – Measurement trend – Operates on a single analog channel source. The TREND:MEASUREMENT command selects the measurement whose trend you want to measure.
 - BTIMing – Chart logic bus timing – Operates on a bus made up of digital channels. The BUS:YINcrement, BUS:YORigin, and BUS:YUNits commands specify function values.
 - BState – Chart logic bus state – Operates on a bus made up of digital channels. The BUS:YINcrement, BUS:YORigin, and BUS:YUNit commands specify function values. The BUS:CLOCK and BUS:SLOPe commands specify the clock source and edge.

Query Syntax :FUNCTION<m>:OPERATION?

The :FUNCTION<m>:OPERATION? query returns the current operation for the selected function.

Return Format <operation><NL>

```

<operation> ::= {ADD | SUBT | MULT | DIV | INT | DIFF | FFT | FFTP
| Sqrt | MAGN | ABS | SQU | LN | LOG | EXP | TEN | LOWP | HIGH
| AVER | SMO | ENV | LIN | MAX | MIN | PEAK | MAXH | MINH | TREN
| BTIM | BST}

```

- See Also
- [":FUNCTION<m> Commands"](#) on page 395
 - [":FUNCTION<m>:SOURCE1"](#) on page 426
 - [":FUNCTION<m>:SOURCE2"](#) on page 428
 - [":FUNCTION<m>:INTEGRATE:IOFFSET"](#) on page 414
 - [":FUNCTION<m>\[:FFT\]:SPAN"](#) on page 409
 - [":FUNCTION<m>\[:FFT\]:CENTER"](#) on page 404
 - [":FUNCTION<m>\[:FFT\]:PHASE:REFERENCE"](#) on page 408
 - [":FUNCTION<m>\[:FFT\]:VTYPE"](#) on page 410
 - [":FUNCTION<m>\[:FFT\]:WINDOW"](#) on page 411
 - [":FUNCTION<m>:LINEAR:GAIN"](#) on page 415
 - [":FUNCTION<m>:LINEAR:OFFSET"](#) on page 416
 - [":FUNCTION<m>:FREQUENCY:LOWPASS"](#) on page 413
 - [":FUNCTION<m>:FREQUENCY:HIGHPASS"](#) on page 412
 - [":FUNCTION<m>:AVERAGE:COUNT"](#) on page 396
 - [":FUNCTION<m>:TREND:MEASUREMENT"](#) on page 429
 - [":FUNCTION<m>:BUS:YINCREMENT"](#) on page 399
 - [":FUNCTION<m>:BUS:YORIGIN"](#) on page 400
 - [":FUNCTION<m>:BUS:YUNITS"](#) on page 401
 - [":FUNCTION<m>:BUS:CLOCK"](#) on page 397
 - [":FUNCTION<m>:BUS:SLOPE"](#) on page 398

:FUNCTION<m>:RANGe

N (see [page 1384](#))

Command Syntax :FUNCTION<m>:RANGe <range>

<m> ::= 1 to (# math functions) in NR1 format

<range> ::= the full-scale vertical axis value in NR3 format.

The :FUNCTION<m>:RANGe command defines the full-scale vertical axis for the selected function.

Query Syntax :FUNCTION<m>:RANGe?

The :FUNCTION<m>:RANGe? query returns the current full-scale range value for the selected function.

Return Format <range><NL>

<range> ::= the full-scale vertical axis value in NR3 format.

- See Also**
- ["Introduction to :FUNCTION<m> Commands"](#) on page 395
 - [":FUNCTION<m>:SCALE"](#) on page 424

:FUNCTION<m>:REFerence

N (see [page 1384](#))

Command Syntax :FUNCTION<m>:REFerence <level>

<m> ::= 1 to (# math functions) in NR1 format

<level> ::= the current reference level in NR3 format.

The :FUNCTION<m>:REFerence command sets the voltage or vertical value represented at center screen for the selected function. The range of legal values is generally +/-10 times the current scale of the selected function, but will vary by function. If you set the reference level to a value outside of the legal range, the level is automatically set to the nearest legal value.

NOTE

The :FUNCTION:REFerence command is equivalent to the :FUNCTION<m>:OFFSet command.

Query Syntax :FUNCTION<m>:REFerence?

The :FUNCTION<m>:REFerence? query outputs the current reference level value for the selected function.

Return Format <level><NL>

<level> ::= the current reference level in NR3 format.

- See Also**
- ["Introduction to :FUNCTION<m> Commands"](#) on page 395
 - [":FUNCTION<m>:OFFSet"](#) on page 417
 - [":FUNCTION<m>:RANGe"](#) on page 422
 - [":FUNCTION<m>:SCALE"](#) on page 424

:FUNCTION<m>:SCALE

N (see [page 1384](#))

Command Syntax :FUNCTION<m>:SCALE <scale value>[<suffix>]
 <m> ::= 1 to (# math functions) in NR1 format
 <scale value> ::= integer in NR1 format
 <suffix> ::= {V | dB}

The :FUNCTION<m>:SCALE command sets the vertical scale, or units per division, of the selected function. Legal values for the scale depend on the selected function.

Query Syntax :FUNCTION<m>:SCALE?

The :FUNCTION<m>:SCALE? query returns the current scale value for the selected function.

Return Format <scale value><NL>
 <scale value> ::= integer in NR1 format

- See Also**
- ["Introduction to :FUNCTION<m> Commands"](#) on page 395
 - [":FUNCTION<m>:RANGe"](#) on page 422

:FUNCTION<m>:SMOoth:POINts

N (see [page 1384](#))

Command Syntax :FUNCTION<m>:SMOoth:POINts <points>

<points> ::= odd integer in NR1 format

When the :FUNCTION<m>:OPERation is SMOoth, the :FUNCTION<m>:SMOoth:POINts command sets the number of smoothing points to use.

You can choose an odd number of points, from 3 up to half of the measurement record or precision analysis record.

Query Syntax :FUNCTION<m>:SMOoth:POINts?

The :FUNCTION<m>:SMOoth:POINts? query returns the number of smoothing points specified.

Return Format <points><NL>

See Also · [":FUNCTION<m>:OPERation"](#) on page 418

:FUNCTION<m>:SOURCE1**N** (see [page 1384](#))**Command Syntax** :FUNCTION<m>:SOURCE1 <value>

<m> ::= 1 to (# math functions) in NR1 format

<value> ::= {CHANnel<n> | FUNCTION<c> | MATH<c> | WMEMory<r> | BUS}

<n> ::= 1 to (# analog channels) in NR1 format

<c> ::= {1}, must be lower than <m>

<r> ::= 1 to (# ref waveforms) in NR1 format

 ::= {1 | 2}

The :FUNCTION<m>:SOURCE1 command is used for any :FUNCTION<m>:OPERation selection. This command selects the first source for the operator math functions or the single source for the transform functions, filter functions, or visualization functions.

The FUNCTION<c> or MATH<c> parameters are available for the transform functions, filter functions, and the magnify visualization function (see ["Introduction to :FUNCTION<m> Commands"](#) on page 395) when <c> is lower than <m>.

In other words, higher math functions can operate on lower math functions when using operators other than the simple arithmetic operations (+, -, *, /). For example, if :FUNCTION1:OPERation is a SUBtract of CHANnel1 and CHANnel2, the :FUNCTION2:OPERation could be set up as a FFT operation on the FUNCTION1 source. These are called cascaded math functions.

To cascade math functions, select the lower math function using the :FUNCTION<m>:SOURCE1 command.

When cascading math functions, to get the most accurate results, be sure to vertically scale lower math functions so that their waveforms take up the full screen without being clipped.

The BUS<m> parameter is available for the bus charting visualization functions.

NOTE

Another shorthand notation for SOURCE1 in this command/query (besides SOUR1) is SOUR.

Query Syntax :FUNCTION<m>:SOURCE1?

The :FUNCTION<m>:SOURCE1? query returns the current source1 for function operations.

Return Format <value><NL>

<value> ::= {CHAN<n> | FUNC<c> | WMEM<r> | BUS}

- See Also
- ["Introduction to :FUNction<m> Commands"](#) on page 395
 - [":FUNction<m>:OPERation"](#) on page 418

:FUNCTION<m>:SOURCE2

N (see [page 1384](#))

Command Syntax :FUNCTION<m>:SOURCE2 <value>

<m> ::= 1 to (# math functions) in NR1 format

<value> ::= {CHANnel<n> | WMEMory<r> | NONE}

<n> ::= 1 to (# analog channels) in NR1 format

<r> ::= 1 to (# ref waveforms) in NR1 format

The :FUNCTION<m>:SOURCE2 command specifies the second source for math operator functions that have two sources. (The :FUNCTION<m>:SOURCE1 command specifies the first source.)

The :FUNCTION<m>:SOURCE2 setting is not used for the transform functions, filter functions, or visualization functions (except when the measurement trend visualization's measurement requires two sources).

Query Syntax :FUNCTION<m>:SOURCE2?

The :FUNCTION<m>:SOURCE2? query returns the currently specified second source for math operations.

Return Format <value><NL>

<value> ::= {CHAN<n> | WMEM<r> | NONE}

- See Also**
- ["Introduction to :FUNCTION<m> Commands"](#) on page 395
 - [":FUNCTION<m>:OPERation"](#) on page 418
 - [":FUNCTION<m>:SOURCE1"](#) on page 426

:FUNCTION<m>:TREND:MEASUREMENT

N (see [page 1384](#))

Command Syntax :FUNCTION<m>:TREND:MEASUREMENT <type>

<m> ::= 1 to (# math functions) in NR1 format

<type> ::= {VAverage | ACRMs | VRATio | PERiod | FREQuency | PWIDth
| NWIDth | DUTYcycle | RISetime | FALLtime}

The :FUNCTION<m>:TREND:MEASUREMENT command selects the measurement whose trend is shown in the math waveform.

Query Syntax :FUNCTION<m>:TREND:MEASUREMENT?

The :FUNCTION<m>:TREND:MEASUREMENT query returns the selected measurement.

Return Format <type><NL>

<type> ::= {VAV | ACRM | VRAT | PER | FREQ | PWID | NWID | DUTY
| RIS | FALL}

See Also • [":FUNCTION<m>:OPERATION"](#) on page 418

19 :HARDcopy Commands

Set and query the selection of hardcopy device and formatting options. See "[Introduction to :HARDcopy Commands](#)" on page 432.

Table 101 :HARDcopy Commands Summary

Command	Query	Options and Query Returns
:HARDcopy:AREA <area> (see page 433)	:HARDcopy:AREA? (see page 433)	<area> ::= SCReen
:HARDcopy:APRinter <active_printer> (see page 434)	:HARDcopy:APRinter? (see page 434)	<active_printer> ::= {<index> <name>} <index> ::= integer index of printer in list <name> ::= name of printer in list
:HARDcopy:FACTors {{0 OFF} {1 ON}} (see page 435)	:HARDcopy:FACTors? (see page 435)	{0 1}
:HARDcopy:FFEed {{0 OFF} {1 ON}} (see page 436)	:HARDcopy:FFEed? (see page 436)	{0 1}
:HARDcopy:INKSaver {{0 OFF} {1 ON}} (see page 437)	:HARDcopy:INKSaver? (see page 437)	{0 1}
:HARDcopy:LAYout <layout> (see page 438)	:HARDcopy:LAYout? (see page 438)	<layout> ::= {LANDscape PORTRait}
:HARDcopy:NETWork:ADD Ress <address> (see page 439)	:HARDcopy:NETWork:ADD Ress? (see page 439)	<address> ::= quoted ASCII string
:HARDcopy:NETWork:APP Ly (see page 440)	n/a	n/a
:HARDcopy:NETWork:DOM ain <domain> (see page 441)	:HARDcopy:NETWork:DOM ain? (see page 441)	<domain> ::= quoted ASCII string

Table 101 :HARDcopy Commands Summary (continued)

Command	Query	Options and Query Returns
:HARDcopy:NETWork:PASSWORD <password> (see page 442)	n/a	<password> ::= quoted ASCII string
:HARDcopy:NETWork:SLOT <slot> (see page 443)	:HARDcopy:NETWork:SLOT? (see page 443)	<slot> ::= {NET0 NET1}
:HARDcopy:NETWork:USERNAME <username> (see page 444)	:HARDcopy:NETWork:USERNAME? (see page 444)	<username> ::= quoted ASCII string
:HARDcopy:PALETTE <palette> (see page 445)	:HARDcopy:PALETTE? (see page 445)	<palette> ::= {COLOR GRAYscale NONE}
n/a	:HARDcopy:PRINTER:LIST? (see page 446)	<list> ::= [<printer_spec>] ... [printer_spec] <printer_spec> ::= "<index>,<active>,<name>;" <index> ::= integer index of printer <active> ::= {Y N} <name> ::= name of printer
:HARDcopy:START (see page 447)	n/a	n/a

Introduction to :HARDcopy Commands

The HARDcopy subsystem provides commands to set and query the selection of hardcopy device and formatting options such as inclusion of instrument settings (FACTors) and generation of formfeed (FFEed).

:HARDC is an acceptable short form for :HARDcopy.

Reporting the Setup

Use :HARDcopy? to query setup information for the HARDcopy subsystem.

Return Format

The following is a sample response from the :HARDcopy? query. In this case, the query was issued following the *RST command.

```
:HARD:APR "" ; AREA SCR ; FACT 0 ; FFE 0 ; INKS 1 ; PAL NONE ; LAY PORT
```

:HARDcopy:AREA

N (see [page 1384](#))

Command Syntax :HARDcopy:AREA <area>

<area> ::= SCReen

The :HARDcopy:AREA command controls what part of the display area is printed. Currently, the only legal choice is SCReen.

Query Syntax :HARDcopy:AREA?

The :HARDcopy:AREA? query returns the selected display area.

Return Format <area><NL>

<area> ::= SCR

- See Also**
- ["Introduction to :HARDcopy Commands"](#) on page 432
 - [":HARDcopy:START"](#) on page 447
 - [":HARDcopy:APRinter"](#) on page 434
 - [":HARDcopy:PRINter:LIST"](#) on page 446
 - [":HARDcopy:FACTors"](#) on page 435
 - [":HARDcopy:FFEed"](#) on page 436
 - [":HARDcopy:INKSaver"](#) on page 437
 - [":HARDcopy:LAYout"](#) on page 438
 - [":HARDcopy:PALette"](#) on page 445

:HARDcopy:APRinter

N (see [page 1384](#))

Command Syntax :HARDcopy:APRinter <active_printer>
 <active_printer> ::= {<index> | <name>}
 <index> ::= integer index of printer in list
 <name> ::= name of printer in list

The :HARDcopy:APRinter command sets the active printer.

Query Syntax :HARDcopy:APRinter?

The :HARDcopy:APRinter? query returns the name of the active printer.

Return Format <name><NL>
 <name> ::= name of printer in list

- See Also**
- ["Introduction to :HARDcopy Commands"](#) on page 432
 - [":HARDcopy:PRINter:LIST"](#) on page 446
 - [":HARDcopy:START"](#) on page 447

:HARDcopy:FACTors

N (see [page 1384](#))

Command Syntax :HARDcopy:FACTors <factors>

<factors> ::= {{OFF | 0} | {ON | 1}}

The :HARDcopy:FACTors command controls whether the scale factors are output on the hardcopy dump.

Query Syntax :HARDcopy:FACTors?

The :HARDcopy:FACTors? query returns a flag indicating whether oscilloscope instrument settings are output on the hardcopy.

Return Format <factors><NL>

<factors> ::= {0 | 1}

- See Also**
- ["Introduction to :HARDcopy Commands"](#) on page 432
 - [":HARDcopy:START"](#) on page 447
 - [":HARDcopy:FFEed"](#) on page 436
 - [":HARDcopy:INKSaver"](#) on page 437
 - [":HARDcopy:LAYout"](#) on page 438
 - [":HARDcopy:PALette"](#) on page 445

:HARDcopy:FFeed

N (see [page 1384](#))

Command Syntax :HARDcopy:FFeed <ffeed>

<ffeed> ::= {{OFF | 0} | {ON | 1}}

The :HARDcopy:FFeed command controls whether a formfeed is output between the screen image and factors of a hardcopy dump.

Query Syntax :HARDcopy:FFeed?

The :HARDcopy:FFeed? query returns a flag indicating whether a formfeed is output at the end of the hardcopy dump.

Return Format <ffeed><NL>

<ffeed> ::= {0 | 1}

- See Also**
- ["Introduction to :HARDcopy Commands"](#) on page 432
 - [":HARDcopy:START"](#) on page 447
 - [":HARDcopy:FACTors"](#) on page 435
 - [":HARDcopy:INKSaver"](#) on page 437
 - [":HARDcopy:LAYout"](#) on page 438
 - [":HARDcopy:PALette"](#) on page 445

:HARDcopy:INKSaver

N (see [page 1384](#))

Command Syntax :HARDcopy:INKSaver <value>
 <value> ::= {{OFF | 0} | {ON | 1}}

The :HARDcopy:INKSaver command controls whether the graticule colors are inverted or not.

Query Syntax :HARDcopy:INKSaver?

The :HARDcopy:INKSaver? query returns a flag indicating whether graticule colors are inverted or not.

Return Format <value><NL>
 <value> ::= {0 | 1}

- See Also**
- ["Introduction to :HARDcopy Commands"](#) on page 432
 - [":HARDcopy:START"](#) on page 447
 - [":HARDcopy:FACTors"](#) on page 435
 - [":HARDcopy:FFEed"](#) on page 436
 - [":HARDcopy:LAYout"](#) on page 438
 - [":HARDcopy:PALette"](#) on page 445

:HARDcopy:LAYout

N (see [page 1384](#))

Command Syntax :HARDcopy:LAYout <layout>
<layout> ::= {LANDscape | PORTRait}

The :HARDcopy:LAYout command sets the hardcopy layout mode.

Query Syntax :HARDcopy:LAYout?

The :HARDcopy:LAYout? query returns the selected hardcopy layout mode.

Return Format <layout><NL>
<layout> ::= {LAND | PORT}

- See Also**
- ["Introduction to :HARDcopy Commands"](#) on page 432
 - [":HARDcopy:START"](#) on page 447
 - [":HARDcopy:FACTors"](#) on page 435
 - [":HARDcopy:PALette"](#) on page 445
 - [":HARDcopy:FFEed"](#) on page 436
 - [":HARDcopy:INKSaver"](#) on page 437

:HARDcopy:NETWork:ADDResS

N (see [page 1384](#))

Command Syntax :HARDcopy:NETWork:ADDResS <address>
 <address> ::= quoted ASCII string

The :HARDcopy:NETWork:ADDResS command sets the address for a network printer slot. The address is the server/computer name and the printer's share name in the \\server\share format.

The network printer slot is selected by the :HARDcopy:NETWork:SLOT command.

To apply the entered address, use the :HARDcopy:NETWork:APPLY command.

Query Syntax :HARDcopy:NETWork:ADDResS?

The :HARDcopy:NETWork:ADDResS? query returns the specified address for the currently selected network printer slot.

Return Format <address><NL>
 <address> ::= quoted ASCII string

- See Also**
- ["Introduction to :HARDcopy Commands"](#) on page 432
 - [":HARDcopy:NETWork:SLOT"](#) on page 443
 - [":HARDcopy:NETWork:APPLY"](#) on page 440
 - [":HARDcopy:NETWork:DOMain"](#) on page 441
 - [":HARDcopy:NETWork:USERname"](#) on page 444
 - [":HARDcopy:NETWork:PASSword"](#) on page 442

:HARDcopy:NETWork:APPLy

N (see [page 1384](#))

Command Syntax :HARDcopy:NETWork:APPLy

The :HARDcopy:NETWork:APPLy command applies the network printer settings and makes the printer connection.

- See Also**
- ["Introduction to :HARDcopy Commands"](#) on page 432
 - [":HARDcopy:NETWork:SLOT"](#) on page 443
 - [":HARDcopy:NETWork:ADDRes"](#) on page 439
 - [":HARDcopy:NETWork:DOMain"](#) on page 441
 - [":HARDcopy:NETWork:USERname"](#) on page 444
 - [":HARDcopy:NETWork:PASSword"](#) on page 442

:HARDcopy:NETWork:DOMain

N (see [page 1384](#))

Command Syntax :HARDcopy:NETWork:DOMain <domain>
 <domain> ::= quoted ASCII string

The :HARDcopy:NETWork:DOMain command sets the Windows network domain name.

The domain name setting is a common setting for both network printer slots.

Query Syntax :HARDcopy:NETWork:DOMain?

The :HARDcopy:NETWork:DOMain? query returns the current Windows network domain name.

Return Format <domain><NL>
 <domain> ::= quoted ASCII string

- See Also**
- ["Introduction to :HARDcopy Commands"](#) on page 432
 - [":HARDcopy:NETWork:SLOT"](#) on page 443
 - [":HARDcopy:NETWork:APPLY"](#) on page 440
 - [":HARDcopy:NETWork:ADDRESS"](#) on page 439
 - [":HARDcopy:NETWork:USERNAME"](#) on page 444
 - [":HARDcopy:NETWork:PASSWORD"](#) on page 442

:HARDcopy:NETWork:PASSword

N (see [page 1384](#))

Command Syntax :HARDcopy:NETWork:PASSword <password>
 <password> ::= quoted ASCII string

The :HARDcopy:NETWork:PASSword command sets the password for the specified Windows network domain and user name.

The password setting is a common setting for both network printer slots.

- See Also**
- ["Introduction to :HARDcopy Commands"](#) on page 432
 - [":HARDcopy:NETWork:USERname"](#) on page 444
 - [":HARDcopy:NETWork:DOMain"](#) on page 441
 - [":HARDcopy:NETWork:SLOT"](#) on page 443
 - [":HARDcopy:NETWork:APPLY"](#) on page 440
 - [":HARDcopy:NETWork:ADDRESS"](#) on page 439

:HARDcopy:NETWork:SLOT

N (see [page 1384](#))

Command Syntax :HARDcopy:NETWork:SLOT <slot>

<slot> ::= {NET0 | NET1}

The :HARDcopy:NETWork:SLOT command selects the network printer slot used for the address and apply commands. There are two network printer slots to choose from.

Query Syntax :HARDcopy:NETWork:SLOT?

The :HARDcopy:NETWork:SLOT? query returns the currently selected network printer slot.

Return Format <slot><NL>

<slot> ::= {NET0 | NET1}

- See Also**
- ["Introduction to :HARDcopy Commands"](#) on page 432
 - [":HARDcopy:NETWork:APPLY"](#) on page 440
 - [":HARDcopy:NETWork:ADDRESS"](#) on page 439
 - [":HARDcopy:NETWork:DOMAIN"](#) on page 441
 - [":HARDcopy:NETWork:USERNAME"](#) on page 444
 - [":HARDcopy:NETWork:PASSWORD"](#) on page 442

:HARDcopy:NETWork:USERname

N (see [page 1384](#))

Command Syntax :HARDcopy:NETWork:USERname <username>
 <username> ::= quoted ASCII string

The :HARDcopy:NETWork:USERname command sets the user name to use when connecting to the Windows network domain.

The user name setting is a common setting for both network printer slots.

Query Syntax :HARDcopy:NETWork:USERname?

The :HARDcopy:NETWork:USERname? query returns the currently set user name.

Return Format <username><NL>

<username> ::= quoted ASCII string

- See Also**
- ["Introduction to :HARDcopy Commands"](#) on page 432
 - [":HARDcopy:NETWork:DOMain"](#) on page 441
 - [":HARDcopy:NETWork:PASSword"](#) on page 442
 - [":HARDcopy:NETWork:SLOT"](#) on page 443
 - [":HARDcopy:NETWork:APPLY"](#) on page 440
 - [":HARDcopy:NETWork:ADDRESS"](#) on page 439

:HARDcopy:PALETTE

N (see [page 1384](#))

Command Syntax :HARDcopy:PALETTE <palette>
 <palette> ::= {COLOR | GRAYscale | NONE}

The :HARDcopy:PALETTE command sets the hardcopy palette color.

The oscilloscope's print driver cannot print color images to color laser printers, so the COLOR option is not available when connected to laser printers.

Query Syntax :HARDcopy:PALETTE?

The :HARDcopy:PALETTE? query returns the selected hardcopy palette color.

Return Format <palette><NL>
 <palette> ::= {COL | GRAY | NONE}

- See Also**
- ["Introduction to :HARDcopy Commands"](#) on page 432
 - [":HARDcopy:START"](#) on page 447
 - [":HARDcopy:FACTors"](#) on page 435
 - [":HARDcopy:LAYout"](#) on page 438
 - [":HARDcopy:FFeed"](#) on page 436
 - [":HARDcopy:INKSaver"](#) on page 437

:HARDcopy:PRINter:LIST

N (see [page 1384](#))

Query Syntax :HARDcopy:PRINter:LIST?

The :HARDcopy:PRINter:LIST? query returns a list of available printers. The list can be empty.

Return Format <list><NL>

<list> ::= [<printer_spec>] ... [printer_spec>]

<printer_spec> ::= "<index>,<active>,<name>;"

<index> ::= integer index of printer

<active> ::= {Y | N}

<name> ::= name of printer (for example "DESKJET 950C")

- See Also**
- ["Introduction to :HARDcopy Commands"](#) on page 432
 - [":HARDcopy:APRinter"](#) on page 434
 - [":HARDcopy:START"](#) on page 447

:HARDcopy:START

N (see [page 1384](#))

Command Syntax :HARDcopy:START

The :HARDcopy:START command starts a print job.

- See Also**
- ["Introduction to :HARDcopy Commands"](#) on page 432
 - [":HARDcopy:APRinter"](#) on page 434
 - [":HARDcopy:PRINter:LIST"](#) on page 446
 - [":HARDcopy:FACTors"](#) on page 435
 - [":HARDcopy:FFEed"](#) on page 436
 - [":HARDcopy:INKSaver"](#) on page 437
 - [":HARDcopy:LAYout"](#) on page 438
 - [":HARDcopy:PALette"](#) on page 445

20 :LISTer Commands

Table 102: LISTer Commands Summary

Command	Query	Options and Query Returns
n/a	:LISTer:DATA? (see page 450)	<binary_block> ::= comma-separated data with newlines at the end of each row
:LISTer:DISPlay { {OFF 0} {SBUS1 ON 1} {SBUS2 2} ALL} (see page 451)	:LISTer:DISPlay? (see page 451)	{OFF SBUS1 SBUS2 ALL}
:LISTer:REference <time_ref> (see page 452)	:LISTer:REference? (see page 452)	<time_ref> ::= {TRIGger PREVIOUS}

Introduction to :LISTer Commands The LISTer subsystem is used to turn on/off the serial decode Lister display and return data from the Lister display.

:LISTer:DATA

N (see [page 1384](#))

Query Syntax :LISTer:DATA?

The :LISTer:DATA? query returns the lister data.

Return Format <binary_block><NL>

<binary_block> ::= comma-separated data with newlines at the
end of each row

- See Also**
- ["Introduction to :LISTer Commands"](#) on page 449
 - [":LISTer:DISPlay"](#) on page 451
 - ["Definite-Length Block Response Data"](#) on page 184

:LISTer:DISPlay

N (see [page 1384](#))

Command Syntax :LISTer:DISPlay <value>

<value> ::= {{OFF | 0} | {SBUS1 | ON | 1} | {SBUS2 | 2} | ALL}

The :LISTer:DISPlay command configures which of the serial buses to display in the Lister, or whether the Lister is off. "ON" or "1" is the same as "SBUS1".

When set to "ALL", the decode information for different buses is interleaved in time.

Serial bus decode must be on before it can be displayed in the Lister.

Query Syntax :LISTer:DISPlay?

The :LISTer:DISPlay? query returns the Lister display setting.

Return Format <value><NL>

<value> ::= {OFF | SBUS1 | SBUS2 | ALL}

- See Also**
- ["Introduction to :LISTer Commands"](#) on page 449
 - [":SBUS<n>:DISPlay"](#) on page 758
 - [":LISTer:DATA"](#) on page 450

:LISTer:REFErence

N (see [page 1384](#))

Command Syntax :LISTer:REFErence <time_ref>

<time_ref> ::= {TRIGger | PREVIOUS}

The :LISTer:REFErence command selects whether the time value for a Lister row is relative to the trigger or the previous Lister row.

Query Syntax :LISTer:REFErence?

The :LISTer:REFErence? query returns the Lister time reference setting.

Return Format <time_ref><NL>

<time_ref> ::= {TRIGger | PREVIOUS}

- See Also**
- ["Introduction to :LISTer Commands"](#) on page 449
 - [":SBUS<n>:DISPlay"](#) on page 758
 - [":LISTer:DATA"](#) on page 450
 - [":LISTer:DISPlay"](#) on page 451

21 :MARKer Commands

Set and query the settings of X-axis markers (X1 and X2 cursors) and the Y-axis markers (Y1 and Y2 cursors). See "[Introduction to :MARKer Commands](#)" on page 455.

Table 103: MARKer Commands Summary

Command	Query	Options and Query Returns
n/a	:MARKer:DYDX? (see page 456)	<return_value> ::= •Y/•X value in NR3 format
:MARKer:MODE <mode> (see page 457)	:MARKer:MODE? (see page 457)	<mode> ::= {OFF MEASurement MANual WAVeform BINary HEX}
:MARKer:X1:DISPlay {{0 OFF} {1 ON}} (see page 458)	:MARKer:X1:DISPlay? (see page 458)	<setting> ::= {0 1}
:MARKer:X1Position <position>[suffix] (see page 459)	:MARKer:X1Position? (see page 459)	<position> ::= X1 cursor position value in NR3 format [suffix] ::= {s ms us ns ps Hz kHz MHz} <return_value> ::= X1 cursor position value in NR3 format
:MARKer:X1Y1source <source> (see page 460)	:MARKer:X1Y1source? (see page 460)	<source> ::= {CHANnel<n> FUNction<m> FFT MATH<m> WMEMory<r>} <n> ::= 1 to (# analog channels) in NR1 format <m> ::= 1 to (# math functions) in NR1 format <r> ::= 1 to (# ref waveforms) in NR1 format <return_value> ::= <source>
:MARKer:X2:DISPlay {{0 OFF} {1 ON}} (see page 461)	:MARKer:X2:DISPlay? (see page 461)	<setting> ::= {0 1}

Table 103:MARKer Commands Summary (continued)

Command	Query	Options and Query Returns
:MARKer:X2Position <position>[suffix] (see page 462)	:MARKer:X2Position? (see page 462)	<position> ::= X2 cursor position value in NR3 format [suffix] ::= {s ms us ns ps Hz kHz MHz} <return_value> ::= X2 cursor position value in NR3 format
:MARKer:X2Y2source <source> (see page 463)	:MARKer:X2Y2source? (see page 463)	<source> ::= {CHANnel<n> FUNction<m> FFT MATH<m> WMEMory<r>} <n> ::= 1 to (# analog channels) in NR1 format <m> ::= 1 to (# math functions) in NR1 format <r> ::= 1 to (# ref waveforms) in NR1 format <return_value> ::= <source>
n/a	:MARKer:XDELta? (see page 464)	<return_value> ::= X cursors delta value in NR3 format
:MARKer:XUNits <mode> (see page 465)	:MARKer:XUNits? (see page 465)	<units> ::= {SEcONds HERTz DEGRees PERCent}
:MARKer:XUNits:USE (see page 466)	n/a	n/a
:MARKer:Y1:DISPlay {0 OFF} {1 ON} (see page 467)	:MARKer:Y1:DISPlay? (see page 467)	<setting> ::= {0 1}
:MARKer:Y1Position <position>[suffix] (see page 468)	:MARKer:Y1Position? (see page 468)	<position> ::= Y1 cursor position value in NR3 format [suffix] ::= {V mV dB} <return_value> ::= Y1 cursor position value in NR3 format
:MARKer:Y2:DISPlay {0 OFF} {1 ON} (see page 469)	:MARKer:Y2:DISPlay? (see page 469)	<setting> ::= {0 1}
:MARKer:Y2Position <position>[suffix] (see page 470)	:MARKer:Y2Position? (see page 470)	<position> ::= Y2 cursor position value in NR3 format [suffix] ::= {V mV dB} <return_value> ::= Y2 cursor position value in NR3 format
n/a	:MARKer:YDELta? (see page 471)	<return_value> ::= Y cursors delta value in NR3 format

Table 103:MARKer Commands Summary (continued)

Command	Query	Options and Query Returns
:MARKer:YUNits <mode> (see page 472)	:MARKer:YUNits? (see page 472)	<units> ::= {BASE PERCent}
:MARKer:YUNits:USE (see page 473)	n/a	n/a

Introduction to :MARKer Commands The MARKer subsystem commands set and query the settings of X-axis markers (X1 and X2 cursors) and the Y-axis markers (Y1 and Y2 cursors). You can set and query the marker mode and source, the position of the X and Y cursors, and query delta X and delta Y cursor values.

Reporting the Setup

Use :MARKer? to query setup information for the MARKer subsystem.

Return Format

The following is a sample response from the :MARKer? query. In this case, the query was issued following a *RST and ":MARKer:MODE MANual" command.

```
:MARK:X1Y1 CHAN1;X2Y2 CHAN1;MODE MAN
```

:MARKer:DYDX

N (see [page 1384](#))

Query Syntax :MARKer:DYDX?

The MARKer:DYDX? query returns the cursor $\Delta Y/\Delta X$ value.

X cursor units are set by the :MARKer:XUNits command.

NOTE

If the front-panel cursors are off, the marker position values are not defined. Make sure to set :MARKer:MODE to MANual or WAVEform to put the cursors in the front-panel Normal mode.

Return Format <value><NL>

<value> ::= •Y/•X value in NR3 format.

- See Also**
- ["Introduction to :MARKer Commands"](#) on page 455
 - [":MARKer:MODE"](#) on page 457
 - [":MARKer:X1Position"](#) on page 459
 - [":MARKer:X2Position"](#) on page 462
 - [":MARKer:X1Y1source"](#) on page 460
 - [":MARKer:X2Y2source"](#) on page 463
 - [":MARKer:XUNits"](#) on page 465

:MARKer:MODE

N (see [page 1384](#))

Command Syntax :MARKer:MODE <mode>

<mode> ::= {OFF | MEASurement | MANual | WAVeform | BINary | HEX}

The :MARKer:MODE command sets the cursors mode:

- OFF – removes the cursor information from the display.
- MANual – enables manual placement of the X and Y cursors.

If the front-panel cursors are off, or are set to the front-panel Hex or Binary mode, setting :MARKer:MODE MANual will put the cursors in the front-panel Normal mode.

- MEASurement – cursors track the most recent measurement.

Setting the mode to MEASurement sets the marker sources (:MARKer:X1Y1source and :MARKer:X2Y2source) to the measurement source (:MEASure:SOURce). Setting the measurement source remotely always sets the marker sources.

- WAVeform – the Y1 cursor tracks the voltage value at the X1 cursor of the waveform specified by the X1Y1source, and the Y2 cursor does the same for the X2 cursor and its X2Y2source.
- BINary – logic levels of displayed waveforms at the current X1 and X2 cursor positions are displayed in the Cursor sidebar dialog in binary.
- HEX – logic levels of displayed waveforms at the current X1 and X2 cursor positions are displayed in the Cursor sidebar dialog in hexadecimal.

Query Syntax :MARKer:MODE?

The :MARKer:MODE? query returns the current cursors mode.

Return Format <mode><NL>

<mode> ::= {OFF | MEAS | MAN | WAV | BIN | HEX}

See Also • ["Introduction to :MARKer Commands"](#) on page 455

- [":MARKer:X1Y1source"](#) on page 460
- [":MARKer:X2Y2source"](#) on page 463
- [":MEASure:SOURce"](#) on page 531
- [":MARKer:X1Position"](#) on page 459
- [":MARKer:X2Position"](#) on page 462
- [":MARKer:Y1Position"](#) on page 468
- [":MARKer:Y2Position"](#) on page 470

:MARKer:X1:DISPlay

N (see [page 1384](#))

Command Syntax :MARKer:X1:DISPlay {{0 | OFF} | {1 | ON}}

The :MARKer:X1:DISPlay command specifies whether the X1 cursor is displayed.

Query Syntax :MARKer:X1:DISPlay?

The :MARKer:X1:DISPlay? query returns the X1 cursor display setting.

Return Format <setting><NL>

<setting> ::= {0 | 1}

See Also • [":MARKer:X1:DISPlay"](#) on page 458

:MARKer:X1Position

N (see [page 1384](#))

Command Syntax :MARKer:X1Position <position> [suffix]
 <position> ::= X1 cursor position in NR3 format
 <suffix> ::= {s | ms | us | ns | ps | Hz | kHz | MHz}

The :MARKer:X1Position command:

- Sets :MARKer:MODE to MANual if it is not currently set to WAVEform (see [":MARKer:MODE"](#) on page 457).
- Sets the X1 cursor position to the specified value.

X cursor units are set by the :MARKer:XUNits command.

Query Syntax :MARKer:X1Position?

The :MARKer:X1Position? query returns the current X1 cursor position. This is functionally equivalent to the obsolete :MEASure:TSTArt command/query.

NOTE

If the front-panel cursors are off, the marker position values are not defined and an error is generated. Make sure to set :MARKer:MODE to MANual or WAVEform to put the cursors in the front-panel Normal mode.

Return Format <position><NL>
 <position> ::= X1 cursor position in NR3 format

- See Also**
- ["Introduction to :MARKer Commands"](#) on page 455
 - [":MARKer:MODE"](#) on page 457
 - [":MARKer:X2Position"](#) on page 462
 - [":MARKer:X1Y1source"](#) on page 460
 - [":MARKer:X2Y2source"](#) on page 463
 - [":MARKer:XUNits"](#) on page 465
 - [":MEASure:TSTArt"](#) on page 1316

:MARKer:X1Y1source

N (see [page 1384](#))

Command Syntax `:MARKer:X1Y1source <source>`

`<source> ::= {CHANnel<n> | FUNction<m> | MATH<m> | FFT | WMEMory<r>}`

`<n> ::= 1 to (# analog channels) in NR1 format`

`<m> ::= 1 to (# math functions) in NR1 format`

`<r> ::= 1 to (# ref waveforms) in NR1 format`

The `:MARKer:X1Y1source` command sets the source for the cursors. The channel you specify must be enabled for cursors to be displayed. If the channel or function is not on, an error message is issued.

If the marker mode is not currently WAVEform (see [":MARKer:MODE"](#) on page 457):

- Sending a `:MARKer:X1Y1source` command will put the cursors in the MANual mode.
- Setting the source for one pair of markers (for example, X1Y1) sets the source for the other (for example, X2Y2).

If the marker mode is currently WAVEform, the X1Y1 source can be set separate from the X2Y2 source.

If `:MARKer:MODE` is set to OFF or MANual, setting `:MEASure:SOURce` to CHANnel<n>, FUNction, MATH, or WMEMory<r> will also set `:MARKer:X1Y1source` and `:MARKer:X2Y2source` to this value.

NOTE

MATH is an alias for FUNction. The query will return FUNC if the source is FUNction or MATH.

Query Syntax `:MARKer:X1Y1source?`

The `:MARKer:X1Y1source?` query returns the current source for the cursors. If all channels are off or if `:MARKer:MODE` is set to OFF, the query returns NONE.

Return Format `<source><NL>`

`<source> ::= {CHAN<n> | FUNC | WMEM<r> | NONE}`

- See Also**
- ["Introduction to :MARKer Commands"](#) on page 455
 - [":MARKer:MODE"](#) on page 457
 - [":MARKer:X2Y2source"](#) on page 463
 - [":MEASure:SOURce"](#) on page 531

:MARKer:X2:DISPlay

N (see [page 1384](#))

Command Syntax :MARKer:X2:DISPlay {{0 | OFF} | {1 | ON}}

The :MARKer:X2:DISPlay command specifies whether the X2 cursor is displayed.

Query Syntax :MARKer:X2:DISPlay?

The :MARKer:X2:DISPlay? query returns the X2 cursor display setting.

Return Format <setting><NL>

<setting> ::= {0 | 1}

See Also • [":MARKer:X2:DISPlay"](#) on page 461

:MARKer:X2Position

N (see [page 1384](#))

Command Syntax :MARKer:X2Position <position> [suffix]
 <position> ::= X2 cursor position in NR3 format
 <suffix> ::= {s | ms | us | ns | ps | Hz | kHz | MHz}

The :MARKer:X2Position command:

- Sets :MARKer:MODE to MANual if it is not currently set to WAVEform (see [":MARKer:MODE"](#) on page 457).
- Sets the X2 cursor position to the specified value.

X cursor units are set by the :MARKer:XUNits command.

Query Syntax :MARKer:X2Position?

The :MARKer:X2Position? query returns current X2 cursor position. This is functionally equivalent to the obsolete :MEASure:TSTOp command/query.

NOTE

If the front-panel cursors are off, the marker position values are not defined and an error is generated. Make sure to set :MARKer:MODE to MANual or WAVEform to put the cursors in the front-panel Normal mode.

Return Format <position><NL>
 <position> ::= X2 cursor position in NR3 format

- See Also**
- ["Introduction to :MARKer Commands"](#) on page 455
 - [":MARKer:MODE"](#) on page 457
 - [":MARKer:X1Position"](#) on page 459
 - [":MARKer:X2Y2source"](#) on page 463
 - [":MARKer:XUNits"](#) on page 465
 - [":MEASure:TSTOp"](#) on page 1317

:MARKer:X2Y2source

N (see [page 1384](#))

Command Syntax :MARKer:X2Y2source <source>

<source> ::= {CHANnel<n> | FUNction<m> | MATH<m> | FFT | WMEMory<r>}

<n> ::= 1 to (# analog channels) in NR1 format

<m> ::= 1 to (# math functions) in NR1 format

<r> ::= 1 to (# ref waveforms) in NR1 format

The :MARKer:X2Y2source command sets the source for the cursors. The channel you specify must be enabled for cursors to be displayed. If the channel or function is not on, an error message is issued.

If the marker mode is not currently WAVEform (see [":MARKer:MODE"](#) on page 457):

- Sending a :MARKer:X2Y2source command will put the cursors in the MANual mode.
- Setting the source for one pair of markers (for example, X2Y2) sets the source for the other (for example, X1Y1).

If the marker mode is currently WAVEform, the X2Y2 source can be set separate from the X1Y1 source.

If :MARKer:MODE is set to OFF or MANual, setting :MEASure:SOURce to CHANnel<n>, FUNction, MATH, or WMEMory<r> will also set :MARKer:X1Y1source and :MARKer:X2Y2source to this value.

NOTE

MATH is an alias for FUNction. The query will return FUNC if the source is FUNction or MATH.

Query Syntax :MARKer:X2Y2source?

The :MARKer:X2Y2source? query returns the current source for the cursors. If all channels are off or if :MARKer:MODE is set to OFF, the query returns NONE.

Return Format <source><NL>

<source> ::= {CHAN<n> | FUNC | WMEM<r> | NONE}

- See Also**
- ["Introduction to :MARKer Commands"](#) on page 455
 - [":MARKer:MODE"](#) on page 457
 - [":MARKer:X1Y1source"](#) on page 460
 - [":MEASure:SOURce"](#) on page 531

:MARKer:XDELta

N (see [page 1384](#))

Query Syntax :MARKer:XDELta?

The MARKer:XDELta? query returns the value difference between the current X1 and X2 cursor positions.

$Xdelta = (\text{Value at X2 cursor}) - (\text{Value at X1 cursor})$

X cursor units are set by the :MARKer:XUNits command.

NOTE

If the front-panel cursors are off, the marker position values are not defined. Make sure to set :MARKer:MODE to MANual or WAVEform to put the cursors in the front-panel Normal mode.

Return Format <value><NL>

<value> ::= difference value in NR3 format.

- See Also**
- ["Introduction to :MARKer Commands"](#) on page 455
 - [":MARKer:MODE"](#) on page 457
 - [":MARKer:X1Position"](#) on page 459
 - [":MARKer:X2Position"](#) on page 462
 - [":MARKer:X1Y1source"](#) on page 460
 - [":MARKer:X2Y2source"](#) on page 463
 - [":MARKer:XUNits"](#) on page 465

:MARKer:XUNits

N (see [page 1384](#))

Command Syntax :MARKer:XUNits <units>

<units> ::= {SECOnds | HERTz | DEGRees | PERCent}

The :MARKer:XUNits command sets the X cursors units:

- SECOnds – for making time measurements.
- HERTz – for making frequency measurements.
- DEGRees – for making phase measurements. Use the :MARKer:XUNits:USE command to set the current X1 location as 0 degrees and the current X2 location as 360 degrees.
- PERCent – for making ratio measurements. Use the :MARKer:XUNits:USE command to set the current X1 location as 0 percent and the current X2 location as 100 percent.

Changing X units affects the input and output values of the :MARKer:X1Position, :MARKer:X2Position, and :MARKer:XDELta commands/queries.

Query Syntax :MARKer:XUNits?

The :MARKer:XUNits? query returns the current X cursors units.

Return Format <units><NL>

<units> ::= {SEC | HERT | DEGR | PERC}

- See Also**
- ["Introduction to :MARKer Commands"](#) on page 455
 - [":MARKer:XUNits:USE"](#) on page 466
 - [":MARKer:X1Y1source"](#) on page 460
 - [":MARKer:X2Y2source"](#) on page 463
 - [":MEASure:SOURce"](#) on page 531
 - [":MARKer:X1Position"](#) on page 459
 - [":MARKer:X2Position"](#) on page 462

:MARKer:XUNits:USE

N (see [page 1384](#))

Command Syntax `:MARKer:XUNits:USE`

When DEGRees is selected for :MARKer:XUNits, the :MARKer:XUNits:USE command sets the current X1 location as 0 degrees and the current X2 location as 360 degrees.

When PERCent is selected for :MARKer:XUNits, the :MARKer:XUNits:USE command sets the current X1 location as 0 percent and the current X2 location as 100 percent.

Once the 0 and 360 degree or 0 and 100 percent locations are set, inputs to and outputs from the :MARKer:X1Position, :MARKer:X2Position, and :MARKer:XDELta commands/queries are relative to the set locations.

- See Also**
- ["Introduction to :MARKer Commands"](#) on page 455
 - [":MARKer:XUNits"](#) on page 465
 - [":MARKer:X1Y1source"](#) on page 460
 - [":MARKer:X2Y2source"](#) on page 463
 - [":MEASure:SOURce"](#) on page 531
 - [":MARKer:X1Position"](#) on page 459
 - [":MARKer:X2Position"](#) on page 462
 - [":MARKer:XDELta"](#) on page 464

:MARKer:Y1:DISPlay

N (see [page 1384](#))

Command Syntax :MARKer:Y1:DISPlay {{0 | OFF} | {1 | ON}}

The :MARKer:Y1:DISPlay command specifies whether the Y1 cursor is displayed.

Query Syntax :MARKer:Y1:DISPlay?

The :MARKer:Y1:DISPlay? query returns the Y1 cursor display setting.

Return Format <setting><NL>

<setting> ::= {0 | 1}

See Also • [":MARKer:Y1:DISPlay"](#) on page 467

:MARKer:Y1Position

N (see [page 1384](#))

Command Syntax :MARKer:Y1Position <position> [suffix]

<position> ::= Y1 cursor position in NR3 format

<suffix> ::= {mV | V | dB}

If the :MARKer:MODE is not currently set to WAVEform (see [":MARKer:MODE"](#) on page 457), the :MARKer:Y1Position command:

- Sets :MARKer:MODE to MANual.
- Sets the Y1 cursor position to the specified value.

Y cursor units are set by the :MARKer:YUNits command.

When the :MARKer:MODE is set to WAVEform, Y positions cannot be set.

Query Syntax :MARKer:Y1Position?

The :MARKer:Y1Position? query returns current Y1 cursor position. This is functionally equivalent to the obsolete :MEASure:VStArt command/query.

NOTE

If the front-panel cursors are off or are set to Binary or Hex Mode, the marker position values are not defined and an error is generated. Make sure to set :MARKer:MODE to MANual or WAVEform to put the cursors in the front-panel Normal mode.

Return Format <position><NL>

<position> ::= Y1 cursor position in NR3 format

- See Also**
- ["Introduction to :MARKer Commands"](#) on page 455
 - [":MARKer:MODE"](#) on page 457
 - [":MARKer:X1Y1source"](#) on page 460
 - [":MARKer:X2Y2source"](#) on page 463
 - [":MARKer:Y2Position"](#) on page 470
 - [":MARKer:YUNits"](#) on page 472
 - [":MEASure:VStArt"](#) on page 1321

:MARKer:Y2:DISPlay

N (see [page 1384](#))

Command Syntax :MARKer:Y2:DISPlay {{0 | OFF} | {1 | ON}}

The :MARKer:Y2:DISPlay command specifies whether the Y2 cursor is displayed.

Query Syntax :MARKer:Y2:DISPlay?

The :MARKer:Y2:DISPlay? query returns the Y2 cursor display setting.

Return Format <setting><NL>

<setting> ::= {0 | 1}

See Also • [":MARKer:Y2:DISPlay"](#) on page 469

:MARKer:Y2Position

N (see [page 1384](#))

Command Syntax :MARKer:Y2Position <position> [suffix]

<position> ::= Y2 cursor position in NR3 format

<suffix> ::= {mV | V | dB}

If the :MARKer:MODE is not currently set to WAVEform (see **":MARKer:MODE"** on page 457), the :MARKer:Y2Position command:

- Sets :MARKer:MODE to MANual.
- Sets the Y2 cursor position to the specified value.

Y cursor units are set by the :MARKer:YUNits command.

When the :MARKer:MODE is set to WAVEform, Y positions cannot be set.

Query Syntax :MARKer:Y2Position?

The :MARKer:Y2Position? query returns current Y2 cursor position. This is functionally equivalent to the obsolete :MEASure:VSTOP command/query.

NOTE

If the front-panel cursors are off or are set to Binary or Hex Mode, the marker position values are not defined and an error is generated. Make sure to set :MARKer:MODE to MANual or WAVEform to put the cursors in the front-panel Normal mode.

Return Format <position><NL>

<position> ::= Y2 cursor position in NR3 format

- See Also**
- ["Introduction to :MARKer Commands"](#) on page 455
 - **":MARKer:MODE"** on page 457
 - **":MARKer:X1Y1source"** on page 460
 - **":MARKer:X2Y2source"** on page 463
 - **":MARKer:Y1Position"** on page 468
 - **":MARKer:YUNits"** on page 472
 - **":MEASure:VSTOP"** on page 1322

:MARKer:YDELta

N (see [page 1384](#))

Query Syntax :MARKer:YDELta?

The :MARKer:YDELta? query returns the value difference between the current Y1 and Y2 cursor positions.

Ydelta = (Value at Y2 cursor) - (Value at Y1 cursor)

NOTE

If the front-panel cursors are off or are set to Binary or Hex Mode, the marker position values are not defined. Make sure to set :MARKer:MODE to MANual or WAVEform to put the cursors in the front-panel Normal mode.

Y cursor units are set by the :MARKer:YUNits command.

Return Format <value><NL>

<value> ::= difference value in NR3 format

- See Also**
- ["Introduction to :MARKer Commands"](#) on page 455
 - [":MARKer:MODE"](#) on page 457
 - [":MARKer:X1Y1source"](#) on page 460
 - [":MARKer:X2Y2source"](#) on page 463
 - [":MARKer:Y1Position"](#) on page 468
 - [":MARKer:Y2Position"](#) on page 470
 - [":MARKer:YUNits"](#) on page 472

:MARKer:YUNits

N (see [page 1384](#))

Command Syntax :MARKer:YUNits <units>
 <units> ::= {BASE | PERCent}

The :MARKer:YUNits command sets the Y cursors units:

- BASE – for making measurements in the units associated with the cursors source.
- PERCent – for making ratio measurements. Use the :MARKer:YUNits:USE command to set the current Y1 location as 0 percent and the current Y2 location as 100 percent.

Changing Y units affects the input and output values of the :MARKer:Y1Position, :MARKer:Y2Position, and :MARKer:YDELta commands/queries.

Query Syntax :MARKer:YUNits?

The :MARKer:YUNits? query returns the current Y cursors units.

Return Format <units><NL>
 <units> ::= {BASE | PERC}

- See Also**
- ["Introduction to :MARKer Commands"](#) on page 455
 - [":MARKer:YUNits:USE"](#) on page 473
 - [":MARKer:X1Y1source"](#) on page 460
 - [":MARKer:X2Y2source"](#) on page 463
 - [":MEASure:SOURce"](#) on page 531
 - [":MARKer:Y1Position"](#) on page 468
 - [":MARKer:Y2Position"](#) on page 470
 - [":MARKer:YDELta"](#) on page 471

:MARKer:YUNits:USE

N (see [page 1384](#))

Command Syntax :MARKer:YUNits:USE

When PERCent is selected for :MARKer:YUNits, the :MARKer:YUNits:USE command sets the current Y1 location as 0 percent and the current Y2 location as 100 percent.

Once the 0 and 100 percent locations are set, inputs to and outputs from the :MARKer:Y1Position, :MARKer:Y2Position, and :MARKer:YDELta commands/queries are relative to the set locations.

- See Also**
- ["Introduction to :MARKer Commands"](#) on page 455
 - [":MARKer:YUNits"](#) on page 472
 - [":MARKer:X1Y1source"](#) on page 460
 - [":MARKer:X2Y2source"](#) on page 463
 - [":MEASure:SOURce"](#) on page 531
 - [":MARKer:Y1Position"](#) on page 468
 - [":MARKer:Y2Position"](#) on page 470
 - [":MARKer:YDELta"](#) on page 471

22 :MEASure Commands

Select automatic measurements to be made and control time markers. See "[Introduction to :MEASure Commands](#)" on page 490.

Table 104 :MEASure Commands Summary

Command	Query	Options and Query Returns
:MEASure:ALL (see page 492)	n/a	n/a
:MEASure:AREa [<interval>] [, <source>] >] (see page 493)	:MEASure:AREa? [<interval>] [, <source>] >] (see page 493)	<interval> ::= {CYCLE DISPLAY} <source> ::= {CHANNEL<n> FUNCTION<m> MATH<m> WMEMORY<r>} <n> ::= 1 to (# analog channels) in NR1 format <m> ::= 1 to (# math functions) in NR1 format <r> ::= 1 to (# ref waveforms) in NR1 format <return_value> ::= area in volt-seconds, NR3 format
:MEASure:BRATe [<source>] (see page 494)	:MEASure:BRATe? [<source>] (see page 494)	<source> ::= {<digital channels> CHANNEL<n> FUNCTION<m> MATH<m> WMEMORY<r>} <digital channels> ::= DIGITAL<d> for the MSO models <d> ::= 0 to (# digital channels - 1) in NR1 format <n> ::= 1 to (# of analog channels) in NR1 format <m> ::= 1 to (# math functions) in NR1 format <r> ::= 1 to (# ref waveforms) in NR1 format <return_value> ::= bit rate in Hz, NR3 format

Table 104:MEASure Commands Summary (continued)

Command	Query	Options and Query Returns
:MEASure:BWIDth [<source>] (see page 495)	:MEASure:BWIDth? [<source>] (see page 495)	<source> ::= {CHANnel<n> FUNctIon<m> MATH<m> WMEMory<r>} <n> ::= 1 to (# analog channels) in NR1 format <m> ::= 1 to (# math functions) in NR1 format <r> ::= 1 to (# ref waveforms) in NR1 format <return_value> ::= burst width in seconds, NR3 format
:MEASure:CLear (see page 496)	n/a	n/a
:MEASure:COUNter [<source>] (see page 497)	:MEASure:COUNter? [<source>] (see page 497)	<source> ::= {CHANnel<n> EXTernal} for DSO models <source> ::= {CHANnel<n> DIGital<d> EXTernal} for MSO models <n> ::= 1 to (# analog channels) in NR1 format <d> ::= 0 to (# digital channels - 1) in NR1 format <return_value> ::= counter frequency in Hertz in NR3 format
:MEASure:DEFine DELay, <delay spec> (see page 499)	:MEASure:DEFine? DELay (see page 501)	<delay spec> ::= <edge_spec1>,<edge_spec2> edge_spec1 ::= [<slope>]<occurrence> edge_spec2 ::= [<slope>]<occurrence> <slope> ::= {+ -} <occurrence> ::= integer
:MEASure:DEFine THResholds, <threshold spec> (see page 499)	:MEASure:DEFine? THResholds (see page 501)	<threshold spec> ::= {STANdard} {<threshold mode>,<upper>, <middle>,<lower>} <threshold mode> ::= {PERCent ABSolute}

Table 104 :MEASure Commands Summary (continued)

Command	Query	Options and Query Returns
:MEASure:DElay [<source1>] [,<source2>] (see page 502)	:MEASure:DElay? [<source1>] [,<source2>] (see page 502)	<source1,2> ::= {CHANnel<n> FUNction<m> MATH<m> WMEMory<r>} <n> ::= 1 to (# analog channels) in NR1 format <m> ::= 1 to (# math functions) in NR1 format <r> ::= 1 to (# ref waveforms) in NR1 format <return_value> ::= floating-point number delay time in seconds in NR3 format
:MEASure:DUAL:CHARge [<interval>] [,<source1>] [,<source 2>] (see page 504)	:MEASure:DUAL:CHARge? [<interval>] [,<source1>] [,<source 2>] (see page 504)	<interval> ::= {CYCLe DISPlay} <source1>,<source2> ::= CHANnel<n> with N2820A probe connected <n> ::= 1 to (# analog channels) in NR1 format <return_value> ::= area in Amp-hours, NR3 format
:MEASure:DUAL:VAMPlit ude [<source1>] [,<source2 >] (see page 505)	:MEASure:DUAL:VAMPlit ude? [<source1>] [,<source2 >] (see page 505)	<source1>,<source2> ::= CHANnel<n> with N2820A probe connected <n> ::= 1 to (# analog channels) in NR1 format <return_value> ::= the amplitude of the selected waveform in volts in NR3 format
:MEASure:DUAL:VAVerag e [<interval>] [,<source1>] [,<source 2>] (see page 506)	:MEASure:DUAL:VAVerag e? [<interval>] [,<source1>] [,<source 2>] (see page 506)	<interval> ::= {CYCLe DISPlay} <source1>,<source2> ::= CHANnel<n> with N2820A probe connected <n> ::= 1 to (# analog channels) in NR1 format <return_value> ::= calculated average voltage in NR3 format
:MEASure:DUAL:VBASe [<source1>] [,<source2 >] (see page 507)	:MEASure:DUAL:VBASe? [<source1>] [,<source2 >] (see page 507)	<source1>,<source2> ::= CHANnel<n> with N2820A probe connected <n> ::= 1 to (# analog channels) in NR1 format <base_voltage> ::= voltage at the base of the selected waveform in NR3 format

Table 104:MEASure Commands Summary (continued)

Command	Query	Options and Query Returns
:MEASure:DUAL:VPP [<source1>] [, <source2>] >] (see page 508)	:MEASure:DUAL:VPP? [<source1>] [, <source2>] >] (see page 508)	<source1>, <source2> ::= CHANNEL<n> with N2820A probe connected <n> ::= 1 to (# analog channels) in NR1 format <return_value> ::= voltage peak-to-peak of the selected waveform in NR3 format
:MEASure:DUAL:VRMS [<interval>] [, <type>] [, <source1>] [, <source2>] >] (see page 509)	:MEASure:DUAL:VRMS? [<interval>] [, <type>] [, <source1>] [, <source2>] >] (see page 509)	<interval> ::= {CYCLE DISPLAY} <type> ::= {AC DC} <source1>, <source2> ::= CHANNEL<n> with N2820A probe connected <n> ::= 1 to (# analog channels) in NR1 format <return_value> ::= calculated RMS voltage in NR3 format
:MEASure:DUTYcycle [<source>] (see page 510)	:MEASure:DUTYcycle? [<source>] (see page 510)	<source> ::= {CHANNEL<n> FUNCTION<m> MATH<m> WMEMORY<r>} for DSO models <source> ::= {CHANNEL<n> DIGITAL<d> FUNCTION<m> MATH<m> WMEMORY<r>} for MSO models <n> ::= 1 to (# analog channels) in NR1 format <m> ::= 1 to (# math functions) in NR1 format <r> ::= 1 to (# ref waveforms) in NR1 format <d> ::= 0 to (# digital channels - 1) in NR1 format <return_value> ::= ratio of positive pulse width to period in NR3 format

Table 104 :MEASure Commands Summary (continued)

Command	Query	Options and Query Returns
:MEASure:FALLtime [<source>] (see page 511)	:MEASure:FALLtime? [<source>] (see page 511)	<p><source> ::= {CHANnel<n> FUNctIon<m> MATH<m> WMEMory<r>} for DSO models <source> ::= {CHANnel<n> DIGital<d> FUNctIon<m> MATH<m> WMEMory<r>} for MSO models</p> <p><n> ::= 1 to (# analog channels) in NR1 format <m> ::= 1 to (# math functions) in NR1 format <r> ::= 1 to (# ref waveforms) in NR1 format <d> ::= 0 to (# digital channels - 1) in NR1 format <return_value> ::= time in seconds between the lower and upper thresholds in NR3 format</p>
:MEASure:FREQuency [<source>] (see page 512)	:MEASure:FREQuency? [<source>] (see page 512)	<p><source> ::= {CHANnel<n> FUNctIon<m> MATH<m> WMEMory<r>} for DSO models <source> ::= {CHANnel<n> DIGital<d> FUNctIon<m> MATH<m> WMEMory<r>} for MSO models</p> <p><n> ::= 1 to (# analog channels) in NR1 format <m> ::= 1 to (# math functions) in NR1 format <r> ::= 1 to (# ref waveforms) in NR1 format <d> ::= 0 to (# digital channels - 1) in NR1 format <return_value> ::= frequency in Hertz in NR3 format</p>

Table 104:MEASure Commands Summary (continued)

Command	Query	Options and Query Returns
:MEASure:NDUTy [<source>] (see page 513)	:MEASure:NDUTy? [<source>] (see page 513)	<source> ::= {CHANnel<n> FUNctIon<m> MATH<m> WMEMory<r>} for DSO models <source> ::= {CHANnel<n> DIGital<d> FUNctIon<m> MATH<m> WMEMory<r>} for MSO models <n> ::= 1 to (# analog channels) in NR1 format <m> ::= 1 to (# math functions) in NR1 format <r> ::= 1 to (# ref waveforms) in NR1 format <d> ::= 0 to (# digital channels - 1) in NR1 format <return_value> ::= ratio of negative pulse width to period in NR3 format
:MEASure:NEDGes [<source>] (see page 514)	:MEASure:NEDGes? [<source>] (see page 514)	<source> ::= {CHANnel<n> FUNctIon<m> MATH<m> WMEMory<r>} <n> ::= 1 to (# analog channels) in NR1 format <m> ::= 1 to (# math functions) in NR1 format <r> ::= 1 to (# ref waveforms) in NR1 format <return_value> ::= the falling edge count in NR3 format
:MEASure:NPULses [<source>] (see page 515)	:MEASure:NPULses? [<source>] (see page 515)	<source> ::= {CHANnel<n> FUNctIon<m> MATH<m> WMEMory<r>} <n> ::= 1 to (# analog channels) in NR1 format <m> ::= 1 to (# math functions) in NR1 format <r> ::= 1 to (# ref waveforms) in NR1 format <return_value> ::= the falling pulse count in NR3 format

Table 104 :MEASure Commands Summary (continued)

Command	Query	Options and Query Returns
:MEASure:NWIDth [<source>] (see page 516)	:MEASure:NWIDth? [<source>] (see page 516)	<source> ::= {CHANnel<n> FUNctIon<m> MATH<m> WMEMory<r>} for DSO models <source> ::= {CHANnel<n> DIGital<d> FUNctIon<m> MATH<m> WMEMory<r>} for MSO models <n> ::= 1 to (# analog channels) in NR1 format <m> ::= 1 to (# math functions) in NR1 format <r> ::= 1 to (# ref waveforms) in NR1 format <d> ::= 0 to (# digital channels - 1) in NR1 format <return_value> ::= negative pulse width in seconds-NR3 format
:MEASure:OVERshoot [<source>] (see page 517)	:MEASure:OVERshoot? [<source>] (see page 517)	<source> ::= {CHANnel<n> FUNctIon<m> MATH<m> WMEMory<r>} <n> ::= 1 to (# analog channels) in NR1 format <m> ::= 1 to (# math functions) in NR1 format <r> ::= 1 to (# ref waveforms) in NR1 format <return_value> ::= the percent of the overshoot of the selected waveform in NR3 format
:MEASure:PEDGes [<source>] (see page 519)	:MEASure:PEDGes? [<source>] (see page 519)	<source> ::= {CHANnel<n> FUNctIon<m> MATH<m> WMEMory<r>} <n> ::= 1 to (# analog channels) in NR1 format <m> ::= 1 to (# math functions) in NR1 format <r> ::= 1 to (# ref waveforms) in NR1 format <return_value> ::= the rising edge count in NR3 format

Table 104:MEASure Commands Summary (continued)

Command	Query	Options and Query Returns
:MEASure:PERiod [<source>] (see page 520)	:MEASure:PERiod? [<source>] (see page 520)	<source> ::= {CHANnel<n> FUNctIon<m> MATH<m> WMEMory<r>} for DSO models <source> ::= {CHANnel<n> DIGital<d> FUNctIon<m> MATH<m> WMEMory<r>} for MSO models <n> ::= 1 to (# analog channels) in NR1 format <m> ::= 1 to (# math functions) in NR1 format <r> ::= 1 to (# ref waveforms) in NR1 format <d> ::= 0 to (# digital channels - 1) in NR1 format <return_value> ::= waveform period in seconds in NR3 format
:MEASure:PHASe [<source1>] [,<source2>] (see page 521)	:MEASure:PHASe? [<source1>] [,<source2>] (see page 521)	<source1,2> ::= {CHANnel<n> FUNctIon<m> MATH<m> WMEMory<r>} <n> ::= 1 to (# analog channels) in NR1 format <m> ::= 1 to (# math functions) in NR1 format <r> ::= 1 to (# ref waveforms) in NR1 format <return_value> ::= the phase angle value in degrees in NR3 format
:MEASure:PPULses [<source>] (see page 522)	:MEASure:PPULses? [<source>] (see page 522)	<source> ::= {CHANnel<n> FUNctIon<m> MATH<m> WMEMory<r>} <n> ::= 1 to (# analog channels) in NR1 format <m> ::= 1 to (# math functions) in NR1 format <r> ::= 1 to (# ref waveforms) in NR1 format <return_value> ::= the rising pulse count in NR3 format

Table 104 :MEASure Commands Summary (continued)

Command	Query	Options and Query Returns
:MEASure:PREShoot [<source>] (see page 523)	:MEASure:PREShoot? [<source>] (see page 523)	<source> ::= {CHANnel<n> FUNctIon<m> MATH<m> WMEMory<r>} <n> ::= 1 to (# analog channels) in NR1 format <m> ::= 1 to (# math functions) in NR1 format <r> ::= 1 to (# ref waveforms) in NR1 format <return_value> ::= the percent of preshoot of the selected waveform in NR3 format
:MEASure:PWIDth [<source>] (see page 524)	:MEASure:PWIDth? [<source>] (see page 524)	<source> ::= {CHANnel<n> FUNctIon<m> MATH<m> WMEMory<r>} for DSO models <source> ::= {CHANnel<n> DIGital<d> FUNctIon<m> MATH<m> WMEMory<r>} for MSO models <n> ::= 1 to (# analog channels) in NR1 format <m> ::= 1 to (# math functions) in NR1 format <r> ::= 1 to (# ref waveforms) in NR1 format <d> ::= 0 to (# digital channels - 1) in NR1 format <return_value> ::= width of positive pulse in seconds in NR3 format
n/a	:MEASure:RESults? <result_list> (see page 525)	<result_list> ::= comma-separated list of measurement results
:MEASure:RISetime [<source>] (see page 528)	:MEASure:RISetime? [<source>] (see page 528)	<source> ::= {CHANnel<n> FUNctIon<m> MATH<m> WMEMory<r>} <n> ::= 1 to (# analog channels) in NR1 format <m> ::= 1 to (# math functions) in NR1 format <r> ::= 1 to (# ref waveforms) in NR1 format <return_value> ::= rise time in seconds in NR3 format

Table 104:MEASure Commands Summary (continued)

Command	Query	Options and Query Returns
:MEASure:SDEVIation [<source>] (see page 529)	:MEASure:SDEVIation? [<source>] (see page 529)	<source> ::= {CHANnel<n> FUNctIon<m> MATH<m> WMEMory<r>} <n> ::= 1 to (# analog channels) in NR1 format <m> ::= 1 to (# math functions) in NR1 format <r> ::= 1 to (# ref waveforms) in NR1 format <return_value> ::= calculated std deviation in NR3 format
:MEASure:SHOW {{0 OFF} {1 ON}} (see page 530)	:MEASure:SHOW? (see page 530)	{0 1}
:MEASure:SOURce <source1> [,<source2>] (see page 531)	:MEASure:SOURce? (see page 531)	<source1,2> ::= {CHANnel<n> FUNctIon<m> MATH<m> WMEMory<r> EXTErnal} for DSO models <source1,2> ::= {CHANnel<n> DIGital<d> FUNctIon<m> MATH<m> WMEMory<r> EXTErnal} for MSO models <n> ::= 1 to (# analog channels) in NR1 format <m> ::= 1 to (# math functions) in NR1 format <r> ::= 1 to (# ref waveforms) in NR1 format <d> ::= 0 to (# digital channels - 1) in NR1 format <return_value> ::= {<source> NONE}
:MEASure:STATistics <type> (see page 533)	:MEASure:STATistics? (see page 533)	<type> ::= {{ON 1} CURREnt MEAN MINimum MAXimum STDDev COUNT} ON ::= all statistics returned
:MEASure:STATistics:D ISPlay {{0 OFF} {1 ON}} (see page 534)	:MEASure:STATistics:D ISPlay? (see page 534)	{0 1}
:MEASure:STATistics:I NCREment (see page 535)	n/a	n/a

Table 104:MEASure Commands Summary (continued)

Command	Query	Options and Query Returns
:MEASure:STATistics:MCOUNT <setting> (see page 536)	:MEASure:STATistics:MCOUNT? (see page 536)	<setting> ::= {INFinite <count>} <count> ::= 2 to 2000 in NR1 format
:MEASure:STATistics:RESet (see page 537)	n/a	n/a
:MEASure:STATistics:RSDeviation {{0 OFF} {1 ON}} (see page 538)	:MEASure:STATistics:RSDeviation? (see page 538)	{0 1}
n/a	:MEASure:TEDGE? <slope><occurrence>[, <source>] (see page 539)	<slope> ::= direction of the waveform <occurrence> ::= the transition to be reported <source> ::= {CHANnel<n> FUNCTION<m> MATH<m> WMemory<r>} for DSO models <source> ::= {CHANnel<n> DIGital<d> FUNCTION<m> MATH<m> WMemory<r>} for MSO models <n> ::= 1 to (# analog channels) in NR1 format <m> ::= 1 to (# math functions) in NR1 format <r> ::= 1 to (# ref waveforms) in NR1 format <d> ::= 0 to (# digital channels - 1) in NR1 format <return_value> ::= time in seconds of the specified transition

Table 104:MEASure Commands Summary (continued)

Command	Query	Options and Query Returns
n/a	:MEASure:TVALue? <value>, [<slope>]<occurrence> [,<source>] (see page 541)	<value> ::= voltage level that the waveform must cross. <slope> ::= direction of the waveform when <value> is crossed. <occurrence> ::= transitions reported. <source> ::= {CHANnel<n> FUNctIon<m> MATH<m> WMEMory<r>} for DSO models <source> ::= {CHANnel<n> DIGital<d> FUNctIon<m> MATH<m> WMEMory<r>} for MSO models <n> ::= 1 to (# analog channels) in NR1 format <m> ::= 1 to (# math functions) in NR1 format <r> ::= 1 to (# ref waveforms) in NR1 format <d> ::= 0 to (# digital channels - 1) in NR1 format <return_value> ::= time in seconds of specified voltage crossing in NR3 format
:MEASure:VAMPLitude [<source>] (see page 543)	:MEASure:VAMPLitude? [<source>] (see page 543)	<source> ::= {CHANnel<n> FUNctIon<m> MATH<m> WMEMory<r>} <n> ::= 1 to (# analog channels) in NR1 format <m> ::= 1 to (# math functions) in NR1 format <r> ::= 1 to (# ref waveforms) in NR1 format <return_value> ::= the amplitude of the selected waveform in volts in NR3 format

Table 104:MEASure Commands Summary (continued)

Command	Query	Options and Query Returns
:MEASure:VAverage [<interval>] [, <source>] >] (see page 544)	:MEASure:VAverage? [<interval>] [, <source>] >] (see page 544)	<interval> ::= {CYCLE DISPLAY} <source> ::= {CHANNEL<n> FUNCTION<m> MATH<m> FFT WMEMORY<r>} <n> ::= 1 to (# analog channels) in NR1 format <m> ::= 1 to (# math functions) in NR1 format <r> ::= 1 to (# ref waveforms) in NR1 format <return_value> ::= calculated average voltage in NR3 format
:MEASure:VBASe [<source>] (see page 545)	:MEASure:VBASe? [<source>] (see page 545)	<source> ::= {CHANNEL<n> FUNCTION<m> MATH<m> WMEMORY<r>} <n> ::= 1 to (# analog channels) in NR1 format <m> ::= 1 to (# math functions) in NR1 format <r> ::= 1 to (# ref waveforms) in NR1 format <base_voltage> ::= voltage at the base of the selected waveform in NR3 format
:MEASure:VMAX [<source>] (see page 546)	:MEASure:VMAX? [<source>] (see page 546)	<source> ::= {CHANNEL<n> FUNCTION<m> FFT MATH<m> WMEMORY<r>} <n> ::= 1 to (# analog channels) in NR1 format <m> ::= 1 to (# math functions) in NR1 format <r> ::= 1 to (# ref waveforms) in NR1 format <return_value> ::= maximum voltage of the selected waveform in NR3 format

Table 104:MEASure Commands Summary (continued)

Command	Query	Options and Query Returns
:MEASure:VMIN [<source>] (see page 547)	:MEASure:VMIN? [<source>] (see page 547)	<source> ::= {CHANnel<n> FUNctIon<m> FFT MATH<m> WMEMory<r>} <n> ::= 1 to (# analog channels) in NR1 format <m> ::= 1 to (# math functions) in NR1 format <r> ::= 1 to (# ref waveforms) in NR1 format <return_value> ::= minimum voltage of the selected waveform in NR3 format
:MEASure:VPP [<source>] (see page 548)	:MEASure:VPP? [<source>] (see page 548)	<source> ::= {CHANnel<n> FUNctIon<m> FFT MATH<m> WMEMory<r>} <n> ::= 1 to (# analog channels) in NR1 format <m> ::= 1 to (# math functions) in NR1 format <r> ::= 1 to (# ref waveforms) in NR1 format <return_value> ::= voltage peak-to-peak of the selected waveform in NR3 format
:MEASure:VRATio [<interval>] [,<source 1>] [,<source2>] (see page 549)	:MEASure:VRATio? [<interval>] [,<source 1>] [,<source2>] (see page 549)	<interval> ::= {CYCLe DISPlay} <source1,2> ::= {CHANnel<n> FUNctIon<m> MATH<m> WMEMory<r>} <n> ::= 1 to (# analog channels) in NR1 format <m> ::= 1 to (# math functions) in NR1 format <r> ::= 1 to (# ref waveforms) in NR1 format <return_value> ::= the ratio value in dB in NR3 format

Table 104 :MEASure Commands Summary (continued)

Command	Query	Options and Query Returns
:MEASure:VRMS [<interval>] [, <type>] [, <source>] (see page 550)	:MEASure:VRMS? [<interval>] [, <type>] [, <source>] (see page 550)	<interval> ::= {CYCLE DISPLAY} <type> ::= {AC DC} <source> ::= {CHANnel<n> FUNctIon<m> MATH<m> WMEMory<r>} <n> ::= 1 to (# analog channels) in NR1 format <m> ::= 1 to (# math functions) in NR1 format <r> ::= 1 to (# ref waveforms) in NR1 format <return_value> ::= calculated dc RMS voltage in NR3 format
n/a	:MEASure:VTIME? <vtime> [, <source>] (see page 551)	<vtime> ::= displayed time from trigger in seconds in NR3 format <source> ::= {CHANnel<n> FUNctIon<m> MATH<m> WMEMory<r>} for DSO models <source> ::= {CHANnel<n> DIGital<d> FUNctIon<m> MATH<m> WMEMory<r>} for MSO models <n> ::= 1 to (# analog channels) in NR1 format <m> ::= 1 to (# math functions) in NR1 format <r> ::= 1 to (# ref waveforms) in NR1 format <d> ::= 0 to (# digital channels - 1) in NR1 format <return_value> ::= voltage at the specified time in NR3 format
:MEASure:VTOP [<source>] (see page 552)	:MEASure:VTOP? [<source>] (see page 552)	<source> ::= {CHANnel<n> FUNctIon<m> MATH<m> WMEMory<r>} <n> ::= 1 to (# analog channels) in NR1 format <m> ::= 1 to (# math functions) in NR1 format <r> ::= 1 to (# ref waveforms) in NR1 format <return_value> ::= voltage at the top of the waveform in NR3 format
:MEASure:WINDow <type> (see page 553)	:MEASure:WINDow? (see page 553)	<type> ::= {MAIN ZOOM AUTO GATE}

Table 104 :MEASure Commands Summary (continued)

Command	Query	Options and Query Returns
:MEASure:XMAX [<source>] (see page 554)	:MEASure:XMAX? [<source>] (see page 554)	<source> ::= {CHANnel<n> FUNctIon<m> FFT MATH<m> WMEMory<r>} <n> ::= 1 to (# analog channels) in NR1 format <m> ::= 1 to (# math functions) in NR1 format <r> ::= 1 to (# ref waveforms) in NR1 format <return_value> ::= horizontal value of the maximum in NR3 format
:MEASure:XMIN [<source>] (see page 555)	:MEASure:XMIN? [<source>] (see page 555)	<source> ::= {CHANnel<n> FUNctIon<m> FFT MATH<m> WMEMory<r>} <n> ::= 1 to (# analog channels) in NR1 format <m> ::= 1 to (# math functions) in NR1 format <r> ::= 1 to (# ref waveforms) in NR1 format <return_value> ::= horizontal value of the maximum in NR3 format

Introduction to :MEASure Commands

The commands in the MEASure subsystem are used to make parametric measurements on displayed waveforms.

Measurement Setup

To make a measurement, the portion of the waveform required for that measurement must be displayed on the oscilloscope screen.

Measurement Type	Portion of waveform that must be displayed
period, duty cycle, or frequency	at least one complete cycle
pulse width	the entire pulse
rise time	rising edge, top and bottom of pulse
fall time	falling edge, top and bottom of pulse

Measurement Error

If a measurement cannot be made (typically because the proper portion of the waveform is not displayed), the value +9.9E+37 is returned for that measurement.

Making Measurements

If more than one waveform, edge, or pulse is displayed, time measurements are made on the portion of the displayed waveform closest to the trigger reference (left, center, or right).

When making measurements in the zoomed (delayed) time base mode (:TIMebase:MODE WINDow), the oscilloscope will attempt to make the measurement inside the zoomed sweep window. If the measurement is an average and there are not three edges, the oscilloscope will revert to the mode of making the measurement at the start of the main sweep.

When the command form is used, the measurement result is displayed on the instrument. When the query form of these measurements is used, the measurement is made one time, and the measurement result is returned over the bus.

Measurements are made on the displayed waveforms specified by the :MEASure:SOURce command. The MATH source is an alias for the FUNCtion source.

Not all measurements are available on the digital channels or FFT (Fast Fourier Transform).

Reporting the Setup

Use the :MEASure? query to obtain setup information for the MEASure subsystem. (Currently, this is only :MEASure:SOURce.)

Return Format

The following is a sample response from the :MEASure? query. In this case, the query was issued following a *RST command.

```
:MEAS:SOUR CHAN1,CHAN2;STAT ON
```

:MEASure:ALL

N (see [page 1384](#))

Command Syntax :MEASure:ALL

This command installs a Snapshot All measurement on the screen.

See Also · ["Introduction to :MEASure Commands"](#) on page 490

:MEASure:AREa

N (see [page 1384](#))

Command Syntax :MEASure:AREa [<interval>][,<source>]
 <interval> ::= {CYCLe | DISPlay}
 <source> ::= {CHANnel<n> | FUNCTION<m> | MATH<m> | WMEMory<r>}
 <n> ::= 1 to (# analog channels) in NR1 format
 <m> ::= 1 to (# math functions) in NR1 format
 <r> ::= 1 to (# ref waveforms) in NR1 format

The :MEASure:AREa command installs an area measurement on screen. Area measurements show the area between the waveform and the ground level.

The <interval> option lets you specify the measurement interval: either an integral number of cycles, or the full screen. If <interval> is not specified, DISPlay is implied.

NOTE

This command is not available if the source is FFT (Fast Fourier Transform).

Query Syntax :MEASure:AREa? [<interval>][,<source>]

The :MEASure:AREa? query measures and returns the area value.

Return Format <value><NL>
 <value> ::= the area value in volt-seconds in NR3 format

See Also

- ["Introduction to :MEASure Commands"](#) on page 490
- [":MEASure:SOURce"](#) on page 531

:MEASure:BRATe

N (see [page 1384](#))

Command Syntax :MEASure:BRATe [<source>]

```
<source> ::= {<digital channels> | CHANnel<n> | FUNction<m> | MATH<m>
| WMEMory<r>}
```

```
<digital channels> ::= DIGital<d> for the MSO models
```

```
<d> ::= 0 to (# digital channels - 1) in NR1 format
```

```
<n> ::= 1 to (# of analog channels) in NR1 format
```

```
<m> ::= 1 to (# math functions) in NR1 format
```

```
<r> ::= 1 to (# ref waveforms) in NR1 format
```

The :MEASure:BRATe command installs a screen measurement and starts the bit rate measurement. If the optional source parameter is specified, the currently specified source is modified.

NOTE

This command is not available if the source is FFT (Fast Fourier Transform).

Query Syntax :MEASure:BRATe? [<source>]

The :MEASure:BRATe? query measures all positive and negative pulse widths on the waveform, takes the minimum value found of either width type and inverts that minimum width to give a value in Hertz.

Return Format <value><NL>

```
<value> ::= the bit rate value in Hertz
```

- See Also**
- ["Introduction to :MEASure Commands"](#) on page 490
 - [":MEASure:SOURce"](#) on page 531
 - [":MEASure:FREQuency"](#) on page 512
 - [":MEASure:PERiod"](#) on page 520

:MEASure:BWIDth

N (see [page 1384](#))

Command Syntax :MEASure:BWIDth [<source>]

<source> ::= {CHANnel<n> | FUNction<m> | MATH<m> | WMEMory<r>}

<n> ::= 1 to (# analog channels) in NR1 format

<m> ::= 1 to (# math functions) in NR1 format

<r> ::= 1 to (# ref waveforms) in NR1 format

The :MEASure:BWIDth command installs a burst width measurement on screen. If the optional source parameter is not specified, the current measurement source is used.

NOTE

This command is not available if the source is FFT (Fast Fourier Transform).

Query Syntax :MEASure:BWIDth? [<source>]

The :MEASure:BWIDth? query measures and returns the width of the burst on the screen.

The burst width is calculated as follows:

$$\text{burst width} = (\text{last edge on screen} - \text{first edge on screen})$$

Return Format <value><NL>

<value> ::= burst width in seconds in NR3 format

- See Also**
- ["Introduction to :MEASure Commands"](#) on page 490
 - [":MEASure:SOURce"](#) on page 531

:MEASure:CLEar

N (see [page 1384](#))

Command Syntax :MEASure:CLEar

This command clears all selected measurements and markers from the screen.

See Also · ["Introduction to :MEASure Commands"](#) on page 490

:MEASure:COUNter

N (see [page 1384](#))

Command Syntax :MEASure:COUNter [<source>]
 <source> ::= {<digital channels> | CHANnel<n> | EXTernal}
 <digital channels> ::= DIGital<d> for the MSO models
 <n> ::= 1 to (# analog channels) in NR1 format
 <d> ::= 0 to (# digital channels - 1) in NR1 format

The :MEASure:COUNter command installs a screen measurement and starts a counter measurement. If the optional source parameter is specified, the current source is modified. Any channel except Math or Reference Waveforms may be selected for the source.

The counter measurement counts trigger level crossings within a certain amount of time (gate time) and displays the results in Hz.

The gate time is the horizontal range of the oscilloscope but is limited to ≥ 0.1 s and ≤ 10 s. Unlike other measurements, the Zoom horizontal timebase window does not gate the Counter measurement.

The Counter measurement can measure frequencies up to the bandwidth of the oscilloscope. The minimum frequency supported is $2.0 / \text{gateTime}$.

Only one counter measurement may be displayed at a time.

NOTE

This command is not available if the source is MATH.

Query Syntax :MEASure:COUNter? [<source>]

The :MEASure:COUNter? query measures and outputs the counter frequency of the specified source.

NOTE

The :MEASure:COUNter? query times out if the counter measurement is installed on the front panel. Use :MEASure:CLEar to remove the front-panel measurement before executing the :MEASure:COUNter? query.

Return Format <source><NL>
 <source> ::= count in Hertz in NR3 format

- See Also**
- ["Introduction to :MEASure Commands"](#) on page 490
 - [":MEASure:SOURce"](#) on page 531
 - [":MEASure:FREQuency"](#) on page 512

- **":MEASure:CLEar"** on page 496

:MEASure:DEFine

N (see [page 1384](#))

Command Syntax :MEASure:DEFine <meas_spec>[,<source>]

<meas_spec> ::= {DELay | THResholds}

The :MEASure:DEFine command sets up the definition for measurements by specifying the delta time or threshold values. Changing these values may affect the results of other measure commands. The table below identifies which measurement results that can be affected by redefining the DELay specification or the THResholds values. For example, changing the THResholds definition from the default 10%, 50%, and 90% values may change the returned measurement result.

MEASure Command	DELay	THResholds
DUTYcycle		X
DELay	X	X
FALLtime		X
FREQuency		X
NWIDth		X
OVERshoot		X
PERiod		X
PHASe		X
PREShoot		X
PWIDth		X
RISetime		X
VAVerage		X
VRMS		X

:MEASure:DEFine DELay Command Syntax :MEASure:DEFine DELay,<delay_spec>[,<source>]

<delay_spec> ::= <edge_spec1>,<edge_spec2>

<edge_spec1> ::= [<slope>]<occurrence>

<edge_spec2> ::= [<slope>]<occurrence>

<slope> ::= {+ | -}

<occurrence> ::= integer

<source> ::= {CHANnel<n> | FUNCTion<m> | MATH<m> | FFT | WMEMory<r>}

<n> ::= 1 to (# analog channels) in NR1 format

`<m> ::= 1 to (# math functions) in NR1 format`

`<r> ::= 1 to (# ref waveforms) in NR1 format`

This command defines the behavior of the :MEASure:DElay? query by specifying the start and stop edge to be used. `<edge_spec1>` specifies the slope and edge number on source1. `<edge_spec2>` specifies the slope and edge number on source2. The measurement is taken as:

$\text{delay} = t(\text{<edge_spec2>}) - t(\text{<edge_spec1>})$

NOTE

The :MEASure:DElay command and the front-panel delay measurement use an auto-edge selection method to determine the actual edge used for the measurement. The :MEASure:DEFine command has no effect on these delay measurements. The edges specified by the :MEASure:DEFine command only define the edges used by the :MEASure:DElay? query.

:MEASure:DEFine THResholds Command Syntax

`:MEASure:DEFine THResholds, <threshold spec> [, <source>]`

`<threshold spec> ::= {STANdard
| {<threshold mode>, <upper>, <middle>, <lower>}}`

`<threshold mode> ::= {PERCent | ABSolute}`

for `<threshold mode> = PERCent`:

`<upper>, <middle>, <lower> ::= A number specifying the upper, middle, and lower threshold percentage values between Vbase and Vtop in NR3 format.`

`<source> ::= {CHANnel<n> | FUNctIon<m> | MATH<m> | FFT | WMEMory<r>}`

`<n> ::= 1 to (# analog channels) in NR1 format`

`<m> ::= 1 to (# math functions) in NR1 format`

`<r> ::= 1 to (# ref waveforms) in NR1 format`

for `<threshold mode> = ABSolute`:

`<upper>, <middle>, <lower> ::= A number specifying the upper, middle, and lower threshold absolute values in NR3 format.`

- STANdard threshold specification sets the lower, middle, and upper measurement thresholds to 10%, 50%, and 90% values between Vbase and Vtop.
- Threshold mode PERCent sets the measurement thresholds to any user-defined percentages between 5% and 95% of values between Vbase and Vtop.
- Threshold mode ABSolute sets the measurement thresholds to absolute values. ABSolute thresholds are dependent on channel scaling (:CHANnel<n>:RANGe or **":CHANnel<n>:SCALE"** on page 309:CHANnel<n>:SCALE), probe attenuation (:CHANnel<n>:PROBe), and probe units (:CHANnel<n>:UNITs). Always set these values first before setting ABSolute thresholds.

Query Syntax :MEASure:DEFine? <meas_spec>[,<source>]

<meas_spec> ::= {DELAy | THResholds}

The :MEASure:DEFine? query returns the current edge specification for the delay measurements setup or the current specification for the thresholds setup.

Return Format for <meas_spec> = DELAy:

{ <edge_spec1> | <edge_spec2> | <edge_spec1>,<edge_spec2>} <NL>

for <meas_spec> = THResholds and <threshold mode> = PERCent:

THR,PERC,<upper>,<middle>,<lower><NL>

<upper>,<middle>,<lower> ::= A number specifying the upper, middle, and lower threshold percentage values between Vbase and Vtop in NR3 format.

for <meas_spec> = THResholds and <threshold mode> = ABSolute:

THR,ABS,<upper>,<middle>,<lower><NL>

<upper>,<middle>,<lower> ::= A number specifying the upper, middle, and lower threshold voltages in NR3 format.

for <threshold spec> = STANdard:

THR,PERC,+90.0,+50.0,+10.0

- See Also**
- ["Introduction to :MEASure Commands"](#) on page 490
 - [":MEASure:DELAy"](#) on page 502
 - [":MEASure:SOURce"](#) on page 531
 - [":CHANnel<n>:RANGE"](#) on page 308
 - [":CHANnel<n>:SCALE"](#) on page 309
 - [":CHANnel<n>:PROBe"](#) on page 299
 - [":CHANnel<n>:UNITs"](#) on page 310

:MEASure:DElAy

N (see [page 1384](#))

Command Syntax :MEASure:DElAy [<source1>] [,<source2>]

<source1>, <source2> ::= {CHANnel<n> | FUNction<m> | MATH<m> | WMEMory<r>}

<n> ::= 1 to (# analog channels) in NR1 format

<m> ::= 1 to (# math functions) in NR1 format

<r> ::= 1 to (# ref waveforms) in NR1 format

The :MEASure:DElAy command places the instrument in the continuous measurement mode and starts a delay measurement.

The measurement is taken as:

$$\text{delay} = t(\text{<edge spec 2>}) - t(\text{<edge spec 1>})$$

where the <edge spec> definitions are set by the :MEASure:DEFine command

NOTE

The :MEASure:DElAy command and the front-panel delay measurement differ from the :MEASure:DElAy? query.

The delay command or front-panel measurement run the delay measurement in auto-edge select mode. In this mode, you can select the edge polarity, but the instrument will select the edges that will make the best possible delay measurement. The source1 edge chosen will be the edge that meets the polarity specified and is closest to the trigger reference point. The source2 edge selected will be that edge of the specified polarity that gives the first of the following criteria:

- The smallest positive delay value that is less than source1 period.
- The smallest negative delay that is less than source1 period.
- The smallest absolute value of delay.

The :MEASure:DElAy? query will make the measurement using the edges specified by the :MEASure:DEFine command.

Query Syntax :MEASure:DElAy? [<source1>] [,<source2>]

The :MEASure:DElAy? query measures and returns the delay between source1 and source2. The delay measurement is made from the user-defined slope and edge count of the signal connected to source1, to the defined slope and edge count of the signal connected to source2. Delay measurement slope and edge parameters are selected using the :MEASure:DEFine command.

Also in the :MEASure:DEFine command, you can set upper, middle, and lower threshold values. *It is the middle threshold value that is used when performing the delay query.* The standard upper, middle, and lower measurement thresholds are

90%, 50%, and 10% values between Vbase and Vtop. If you want to move the delay measurement point nearer to Vtop or Vbase, you must change the threshold values with the :MEASure:DEFine THResholds command.

Return Format <value><NL>

<value> ::= floating-point number delay time in seconds in NR3 format

- See Also**
- ["Introduction to :MEASure Commands"](#) on page 490
 - [":MEASure:DEFine"](#) on page 499
 - [":MEASure:PHASe"](#) on page 521

:MEASure:DUAL:CHARge

N (see [page 1384](#))

Overview This measurement is available with the N2820A high sensitivity current probe when both the Primary and Secondary probe cables are used. This measurement joins the Zoom In waveform data below the probe's clamp level with Zoom Out waveform data above the probe's clamp level to create the waveform on which the measurement is made.

Command Syntax `:MEASure:DUAL:CHARge [<interval>] [,<source1>] [,<source2>]`
`<interval> ::= {CYCLe | DISPlay}`
`<source1>,<source2> ::= CHANnel<n> with N2820A probe connected`
`<n> ::= 1 to (# analog channels) in NR1 format`

The `:MEASure:DUAL:CHARge` command installs a charge measurement on screen. Charge measurements show the area between the waveform and the ground level.

The `<interval>` option lets you specify the measurement interval: either an integral number of cycles, or the full screen. If `<interval>` is not specified, `DISPlay` is implied.

If the optional source parameter(s) are specified, the currently specified source(s) are modified.

Query Syntax `:MEASure:DUAL:CHARge? [<interval>] [,<source1>] [,<source2>]`

The `:MEASure:DUAL:CHARge?` query measures and returns the charge measurement value.

Return Format `<value><NL>`
`<value> ::= the charge value in Amp-hours in NR3 format`

- See Also**
- [":MEASure:DUAL:VAMPLitude"](#) on page 505
 - [":MEASure:DUAL:VAverage"](#) on page 506
 - [":MEASure:DUAL:VBASe"](#) on page 507
 - [":MEASure:DUAL:VPP"](#) on page 508
 - [":MEASure:DUAL:VRMS"](#) on page 509
 - ["Introduction to :MEASure Commands"](#) on page 490
 - [":MEASure:SOURce"](#) on page 531

:MEASure:DUAL:VAMplitude

N (see [page 1384](#))

Overview This measurement is available with the N2820A high sensitivity current probe when both the Primary and Secondary probe cables are used. This measurement joins the Zoom In waveform data below the probe's clamp level with Zoom Out waveform data above the probe's clamp level to create the waveform on which the measurement is made.

Command Syntax :MEASure:DUAL:VAMplitude [<source1>] [,<source2>]
 <source1>,<source2> ::= CHANnel<n> with N2820A probe connected
 <n> ::= 1 to (# analog channels) in NR1 format

The :MEASure:DUAL:VAMplitude command installs a screen measurement and starts a vertical amplitude measurement.

If the optional source parameter(s) are specified, the currently specified source(s) are modified.

Query Syntax :MEASure:DUAL:VAMplitude? [<source1>] [,<source2>]

The :MEASure:DUAL:VAMplitude? query measures and returns the vertical amplitude of the waveform. To determine the amplitude, the instrument measures Vtop and Vbase, then calculates the amplitude as follows:

$$\text{vertical amplitude} = V_{\text{top}} - V_{\text{base}}$$

Return Format <value><NL>
 <value> ::= the amplitude of the selected waveform in NR3 format

- See Also**
- [":MEASure:DUAL:CHARge"](#) on page 504
 - [":MEASure:DUAL:VAverage"](#) on page 506
 - [":MEASure:DUAL:VBASe"](#) on page 507
 - [":MEASure:DUAL:VPP"](#) on page 508
 - [":MEASure:DUAL:VRMS"](#) on page 509
 - ["Introduction to :MEASure Commands"](#) on page 490
 - [":MEASure:SOURce"](#) on page 531
 - [":MEASure:VTOP"](#) on page 552

:MEASure:DUAL:VAverage

N (see [page 1384](#))

Overview This measurement is available with the N2820A high sensitivity current probe when both the Primary and Secondary probe cables are used. This measurement joins the Zoom In waveform data below the probe's clamp level with Zoom Out waveform data above the probe's clamp level to create the waveform on which the measurement is made.

Command Syntax `:MEASure:DUAL:VAverage [<interval>] [,<source1>] [,<source2>]`
`<interval> ::= {CYCLe | DISPlay}`
`<source1>,<source2> ::= CHANnel<n> with N2820A probe connected`
`<n> ::= 1 to (# analog channels) in NR1 format`

The `:MEASure:DUAL:VAverage` command installs a screen measurement and starts an average value measurement.

The `<interval>` option lets you specify the measurement interval: either an integral number of cycles, or the full screen. If `<interval>` is not specified, `DISPlay` is implied.

If the optional source parameter(s) are specified, the currently specified source(s) are modified.

Query Syntax `:MEASure:DUAL:VAverage? [<interval>] [,<source1>] [,<source2>]`

The `:MEASure:DUAL:VAverage?` query returns the average value measurement.

Return Format `<value><NL>`
`<value> ::= calculated average value in NR3 format`

- See Also**
- [":MEASure:DUAL:CHARge"](#) on page 504
 - [":MEASure:DUAL:VAMPLitude"](#) on page 505
 - [":MEASure:DUAL:VBASe"](#) on page 507
 - [":MEASure:DUAL:VPP"](#) on page 508
 - [":MEASure:DUAL:VRMS"](#) on page 509
 - ["Introduction to :MEASure Commands"](#) on page 490
 - [":MEASure:SOURce"](#) on page 531

:MEASure:DUAL:VBASe

N (see [page 1384](#))

Overview This measurement is available with the N2820A high sensitivity current probe when both the Primary and Secondary probe cables are used. This measurement joins the Zoom In waveform data below the probe's clamp level with Zoom Out waveform data above the probe's clamp level to create the waveform on which the measurement is made.

Command Syntax :MEASure:DUAL:VBASe [<source1>] [,<source2>]

<source1>,<source2> ::= CHANnel<n> with N2820A probe connected

<n> ::= 1 to (# analog channels) in NR1 format

The :MEASure:DUAL:VBASe command installs a screen measurement and starts a waveform base value measurement.

If the optional source parameter(s) are specified, the currently specified source(s) are modified.

Query Syntax :MEASure:DUAL:VBASe? [<source1>] [,<source2>]

The :MEASure:DUAL:VBASe? query returns the vertical value at the base of the waveform. The base value of a pulse is normally not the same as the minimum value.

Return Format <base_voltage><NL>

<base_voltage> ::= value at the base of the selected waveform in NR3 format

- See Also**
- [":MEASure:DUAL:CHARge"](#) on page 504
 - [":MEASure:DUAL:VAMPlitude"](#) on page 505
 - [":MEASure:DUAL:VAverage"](#) on page 506
 - [":MEASure:DUAL:VPP"](#) on page 508
 - [":MEASure:DUAL:VRMS"](#) on page 509
 - ["Introduction to :MEASure Commands"](#) on page 490
 - [":MEASure:SOURce"](#) on page 531
 - [":MEASure:VTOP"](#) on page 552
 - [":MEASure:VMIN"](#) on page 547

:MEASure:DUAL:VPP

N (see [page 1384](#))

Overview This measurement is available with the N2820A high sensitivity current probe when both the Primary and Secondary probe cables are used. This measurement joins the Zoom In waveform data below the probe's clamp level with Zoom Out waveform data above the probe's clamp level to create the waveform on which the measurement is made.

Command Syntax `:MEASure:DUAL:VPP [<source1>] [,<source2>]`

`<source1>,<source2> ::= CHANnel<n> with N2820A probe connected`

`<n> ::= 1 to (# analog channels) in NR1 format`

The `:MEASure:DUAL:VPP` command installs a screen measurement and starts a vertical peak-to-peak measurement.

If the optional source parameter(s) are specified, the currently specified source(s) are modified.

Query Syntax `:MEASure:DUAL:VPP? [<source1>] [,<source2>]`

The `:MEASure:DUAL:VPP?` query measures the maximum and minimum vertical value for the selected source, then calculates the vertical peak-to-peak value and returns that value. The peak-to-peak value (Vpp) is calculated with the following formula:

$$V_{pp} = V_{max} - V_{min}$$

Vmax and Vmin are the vertical maximum and minimum values present on the selected source.

Return Format `<value><NL>`

`<value> ::= vertical peak to peak value in NR3 format`

- See Also**
- [":MEASure:DUAL:CHARge"](#) on page 504
 - [":MEASure:DUAL:VAMplitude"](#) on page 505
 - [":MEASure:DUAL:VAverage"](#) on page 506
 - [":MEASure:DUAL:VBASe"](#) on page 507
 - [":MEASure:DUAL:VRMS"](#) on page 509
 - ["Introduction to :MEASure Commands"](#) on page 490
 - [":MEASure:SOURce"](#) on page 531
 - [":MEASure:VMAX"](#) on page 546
 - [":MEASure:VMIN"](#) on page 547

:MEASure:DUAL:VRMS

N (see [page 1384](#))

Overview This measurement is available with the N2820A high sensitivity current probe when both the Primary and Secondary probe cables are used. This measurement joins the Zoom In waveform data below the probe's clamp level with Zoom Out waveform data above the probe's clamp level to create the waveform on which the measurement is made.

Command Syntax :MEASure:DUAL:VRMS [<interval>] [, <type>] [, <source1>] [, <source2>]

<interval> ::= {CYCLe | DISPlay}

<type> ::= {AC | DC}

<source1>, <source2> ::= CHANnel<n> with N2820A probe connected

<n> ::= 1 to (# analog channels) in NR1 format

The :MEASure:DUAL:VRMS command installs a screen measurement and starts an RMS value measurement.

The <interval> option lets you specify the measurement interval: either an integral number of cycles, or the full screen. If <interval> is not specified, DISPlay is implied.

The <type> option lets you choose between a DC RMS measurement and an AC RMS measurement. If <type> is not specified, DC is implied.

If the optional source parameter(s) are specified, the currently specified source(s) are modified.

Query Syntax :MEASure:DUAL:VRMS? [<interval>] [, <type>] [, <source1>] [, <source2>]

The :MEASure:DUAL:VRMS? query measures and outputs the RMS value measurement.

Return Format <value><NL>

<value> ::= calculated dc RMS value in NR3 format

- See Also**
- [":MEASure:DUAL:CHARge"](#) on page 504
 - [":MEASure:DUAL:VAMplitude"](#) on page 505
 - [":MEASure:DUAL:VAverage"](#) on page 506
 - [":MEASure:DUAL:VBASe"](#) on page 507
 - [":MEASure:DUAL:VPP"](#) on page 508
 - ["Introduction to :MEASure Commands"](#) on page 490
 - [":MEASure:SOURce"](#) on page 531

:MEASure:DUTYcycle

C (see [page 1384](#))

Command Syntax :MEASure:DUTYcycle [<source>]

<source> ::= {<digital channels> | CHANnel<n> | FUNction<m> | MATH<m>
| WMEMory<r>}

<digital channels> ::= DIGital<d> for the MSO models

<d> ::= 0 to (# digital channels - 1) in NR1 format

<n> ::= 1 to (# of analog channels) in NR1 format

<m> ::= 1 to (# math functions) in NR1 format

<r> ::= 1 to (# ref waveforms) in NR1 format

The :MEASure:DUTYcycle command installs a screen measurement and starts a positive duty cycle measurement on the current :MEASure:SOURce. If the optional source parameter is specified, the current source is modified.

NOTE

The signal must be displayed to make the measurement. This command is not available if the source is FFT (Fast Fourier Transform).

Query Syntax :MEASure:DUTYcycle? [<source>]

The :MEASure:DUTYcycle? query measures and outputs the positive duty cycle of the signal specified by the :MEASure:SOURce command. The value returned for the duty cycle is the ratio of the positive pulse width to the period. The positive pulse width and the period of the specified signal are measured, then the duty cycle is calculated with the following formula:

$$+duty\ cycle = (+pulse\ width/period)*100$$

Return Format <value><NL>

<value> ::= ratio of positive pulse width to period in NR3 format

- See Also**
- ["Introduction to :MEASure Commands"](#) on page 490
 - [":MEASure:PERiod"](#) on page 520
 - [":MEASure:PWIDth"](#) on page 524
 - [":MEASure:SOURce"](#) on page 531
 - [":MEASure:NDUTy"](#) on page 513

Example Code • ["Example Code"](#) on page 532

:MEASure:FALLtime

C (see [page 1384](#))

Command Syntax :MEASure:FALLtime [<source>]
 <source> ::= {CHANnel<n> | FUNction<m> | MATH<m> | WMEMory<r>}
 <n> ::= 1 to (# analog channels) in NR1 format
 <m> ::= 1 to (# math functions) in NR1 format
 <r> ::= 1 to (# ref waveforms) in NR1 format

The :MEASure:FALLtime command installs a screen measurement and starts a fall-time measurement. For highest measurement accuracy, set the sweep speed as fast as possible, while leaving the falling edge of the waveform on the display. If the optional source parameter is specified, the current source is modified.

NOTE

This command is not available if the source is FFT (Fast Fourier Transform).

Query Syntax :MEASure:FALLtime? [<source>]

The :MEASure:FALLtime? query measures and outputs the fall time of the displayed falling (negative-going) edge closest to the trigger reference. The fall time is determined by measuring the time at the upper threshold of the falling edge, then measuring the time at the lower threshold of the falling edge, and calculating the fall time with the following formula:

$$\text{fall time} = \text{time at lower threshold} - \text{time at upper threshold}$$

Return Format <value><NL>
 <value> ::= time in seconds between the lower threshold and upper threshold in NR3 format

- See Also**
- ["Introduction to :MEASure Commands"](#) on page 490
 - [":MEASure:RISetime"](#) on page 528
 - [":MEASure:SOURce"](#) on page 531

:MEASure:FREQuency

C (see [page 1384](#))

Command Syntax :MEASure:FREQuency [<source>]

<source> ::= {<digital channels> | CHANnel<n> | FUNction<m> | MATH<m>
| WMEMory<r>}

<digital channels> ::= DIGital<d> for the MSO models

<d> ::= 0 to (# digital channels - 1) in NR1 format

<n> ::= 1 to (# of analog channels) in NR1 format

<m> ::= 1 to (# math functions) in NR1 format

<r> ::= 1 to (# ref waveforms) in NR1 format

The :MEASure:FREQuency command installs a screen measurement and starts a frequency measurement. If the optional source parameter is specified, the current source is modified.

IF the edge on the screen closest to the trigger reference is rising:

THEN frequency = 1/(time at trailing rising edge - time at leading rising edge)

ELSE frequency = 1/(time at trailing falling edge - time at leading falling edge)

NOTE

This command is not available if the source is FFT (Fast Fourier Transform).

Query Syntax :MEASure:FREQuency? [<source>]

The :MEASure:FREQuency? query measures and outputs the frequency of the cycle on the screen closest to the trigger reference.

Return Format <source><NL>

<source> ::= frequency in Hertz in NR3 format

- See Also**
- ["Introduction to :MEASure Commands"](#) on page 490
 - [":MEASure:SOURce"](#) on page 531
 - [":MEASure:PERiod"](#) on page 520

Example Code • ["Example Code"](#) on page 532

:MEASure:NDUTy

N (see [page 1384](#))

Command Syntax :MEASure:NDUTy [<source>]

```
<source> ::= {<digital channels> | CHANnel<n> | FUNction<m> | MATH<m>
             | WMEMory<r>}
```

```
<digital channels> ::= DIGital<d> for the MSO models
```

```
<d> ::= 0 to (# digital channels - 1) in NR1 format
```

```
<n> ::= 1 to (# of analog channels) in NR1 format
```

```
<m> ::= 1 to (# math functions) in NR1 format
```

```
<r> ::= 1 to (# ref waveforms) in NR1 format
```

The :MEASure:NDUTy command installs a screen measurement and starts a negative duty cycle measurement on the current :MEASure:SOURce. If the optional source parameter is specified, the current source is modified.

NOTE

The signal must be displayed to make the measurement. This command is not available if the source is FFT (Fast Fourier Transform).

Query Syntax :MEASure:NDUTy? [<source>]

The :MEASure:NDUTy? query measures and outputs the negative duty cycle of the signal specified by the :MEASure:SOURce command. The value returned for the duty cycle is the ratio of the negative pulse width to the period. The negative pulse width and the period of the specified signal are measured, then the duty cycle is calculated with the following formula:

$$-\text{duty cycle} = (-\text{pulse width}/\text{period}) * 100$$

Return Format <value><NL>

```
<value> ::= ratio of negative pulse width to period in NR3 format
```

- See Also**
- ["Introduction to :MEASure Commands"](#) on page 490
 - [":MEASure:PERiod"](#) on page 520
 - [":MEASure:NWIDth"](#) on page 516
 - [":MEASure:SOURce"](#) on page 531
 - [":MEASure:DUTYcycle"](#) on page 510

:MEASure:NEDGes

N (see [page 1384](#))

Command Syntax :MEASure:NEDGes [<source>]

<source> ::= {CHANnel<n> | FUNction<m> | MATH<m> | WMEMory<r>}

<n> ::= 1 to (# analog channels) in NR1 format

<m> ::= 1 to (# math functions) in NR1 format

<r> ::= 1 to (# ref waveforms) in NR1 format

The :MEASure:NEDGes command installs a falling edge count measurement on screen. If the optional source parameter is not specified, the current source is measured.

NOTE

This command is not available if the source is FFT (Fast Fourier Transform).

Query Syntax :MEASure:NEDGes? [<source>]

The :MEASure:NEDGes? query measures and returns the on-screen falling edge count.

Return Format <value><NL>

<value> ::= the falling edge count in NR3 format

- See Also**
- ["Introduction to :MEASure Commands"](#) on page 490
 - [":MEASure:SOURce"](#) on page 531

:MEASure:NPULses

N (see [page 1384](#))

Command Syntax :MEASure:NPULses [<source>]
 <source> ::= {CHANnel<n> | FUNCTION<m> | MATH<m> | WMEMory<r>}
 <n> ::= 1 to (# analog channels) in NR1 format
 <m> ::= 1 to (# math functions) in NR1 format
 <r> ::= 1 to (# ref waveforms) in NR1 format

The :MEASure:NPULses command installs a falling pulse count measurement on screen. If the optional source parameter is not specified, the current source is measured.

NOTE

This command is not available if the source is FFT (Fast Fourier Transform).

Query Syntax :MEASure:NPULses? [<source>]

The :MEASure:NPULses? query measures and returns the on-screen falling pulse count.

Return Format <value><NL>
 <value> ::= the falling pulse count in NR3 format

- See Also**
- ["Introduction to :MEASure Commands"](#) on page 490
 - [":MEASure:SOURce"](#) on page 531

:MEASure:NWIDth

C (see [page 1384](#))

Command Syntax :MEASure:NWIDth [<source>]

<source> ::= {<digital channels> | CHANnel<n> | FUNction<m> | MATH<m>
| WMEMory<r>}

<digital channels> ::= DIGital<d> for the MSO models

<d> ::= 0 to (# digital channels - 1) in NR1 format

<n> ::= 1 to (# of analog channels) in NR1 format

<m> ::= 1 to (# math functions) in NR1 format

<r> ::= 1 to (# ref waveforms) in NR1 format

The :MEASure:NWIDth command installs a screen measurement and starts a negative pulse width measurement. If the optional source parameter is not specified, the current source is modified.

NOTE

This command is not available if the source is FFT (Fast Fourier Transform).

Query Syntax :MEASure:NWIDth? [<source>]

The :MEASure:NWIDth? query measures and outputs the width of the negative pulse on the screen closest to the trigger reference using the midpoint between the upper and lower thresholds.

FOR the negative pulse closest to the trigger point:

width = (time at trailing rising edge - time at leading falling edge)

Return Format <value><NL>

<value> ::= negative pulse width in seconds in NR3 format

- See Also**
- ["Introduction to :MEASure Commands"](#) on page 490
 - [":MEASure:SOURce"](#) on page 531
 - [":MEASure:PWIDth"](#) on page 524
 - [":MEASure:PERiod"](#) on page 520

:MEASure:OVERshoot

C (see [page 1384](#))

Command Syntax :MEASure:OVERshoot [<source>]
 <source> ::= {CHANnel<n> | FUNCTION<m> | MATH<m> | WMEMory<r>}
 <n> ::= 1 to (# analog channels) in NR1 format
 <m> ::= 1 to (# math functions) in NR1 format
 <r> ::= 1 to (# ref waveforms) in NR1 format

The :MEASure:OVERshoot command installs a screen measurement and starts an overshoot measurement. If the optional source parameter is specified, the current source is modified.

NOTE

This command is not available if the source is FFT (Fast Fourier Transform).

Query Syntax :MEASure:OVERshoot? [<source>]

The :MEASure:OVERshoot? query measures and returns the overshoot of the edge closest to the trigger reference, displayed on the screen. The method used to determine overshoot is to make three different vertical value measurements: Vtop, Vbase, and either Vmax or Vmin, depending on whether the edge is rising or falling.

For a rising edge:

$$\text{overshoot} = ((V_{\text{max}} - V_{\text{top}}) / (V_{\text{top}} - V_{\text{base}})) \times 100$$

For a falling edge:

$$\text{overshoot} = ((V_{\text{base}} - V_{\text{min}}) / (V_{\text{top}} - V_{\text{base}})) \times 100$$

Vtop and Vbase are taken from the normal histogram of all waveform vertical values. The extremum of Vmax or Vmin is taken from the waveform interval right after the chosen edge, halfway to the next edge. This more restricted definition is used instead of the normal one, because it is conceivable that a signal may have more preshoot than overshoot, and the normal extremum would then be dominated by the preshoot of the following edge.

Return Format <overshoot><NL>
 <overshoot> ::= the percent of the overshoot of the selected waveform in NR3 format

- See Also**
- ["Introduction to :MEASure Commands"](#) on page 490
 - [":MEASure:PREShoot"](#) on page 523
 - [":MEASure:SOURce"](#) on page 531

- **":MEASure:VMAX"** on page 546
- **":MEASure:VTOP"** on page 552
- **":MEASure:VBASe"** on page 545
- **":MEASure:VMIN"** on page 547

:MEASure:PEDGes

N (see [page 1384](#))

Command Syntax :MEASure:PEDGes [<source>]

<source> ::= {CHANnel<n> | FUNction<m> | MATH<m> | WMEMory<r>}

<n> ::= 1 to (# analog channels) in NR1 format

<m> ::= 1 to (# math functions) in NR1 format

<r> ::= 1 to (# ref waveforms) in NR1 format

The :MEASure:PEDGes command installs a rising edge count measurement on screen. If the optional source parameter is not specified, the current source is measured.

NOTE

This command is not available if the source is FFT (Fast Fourier Transform).

Query Syntax :MEASure:PEDGes? [<source>]

The :MEASure:PEDGes? query measures and returns the on-screen rising edge count.

Return Format <value><NL>

<value> ::= the rising edge count in NR3 format

- See Also**
- ["Introduction to :MEASure Commands"](#) on page 490
 - [":MEASure:SOURce"](#) on page 531

:MEASure:PERiod

C (see [page 1384](#))

Command Syntax :MEASure:PERiod [<source>]

<source> ::= {<digital channels> | CHANnel<n> | FUNction<m> | MATH<m>
| WMEMory<r>}

<digital channels> ::= DIGital<d> for the MSO models

<d> ::= 0 to (# digital channels - 1) in NR1 format

<n> ::= 1 to (# of analog channels) in NR1 format

<m> ::= 1 to (# math functions) in NR1 format

<r> ::= 1 to (# ref waveforms) in NR1 format

The :MEASure:PERiod command installs a screen measurement and starts the period measurement. If the optional source parameter is specified, the current source is modified.

NOTE

This command is not available if the source is FFT (Fast Fourier Transform).

Query Syntax :MEASure:PERiod? [<source>]

The :MEASure:PERiod? query measures and outputs the period of the cycle closest to the trigger reference on the screen. The period is measured at the midpoint of the upper and lower thresholds.

IF the edge closest to the trigger reference on screen is rising:

THEN period = (time at trailing rising edge - time at leading rising edge)

ELSE period = (time at trailing falling edge - time at leading falling edge)

Return Format <value><NL>

<value> ::= waveform period in seconds in NR3 format

- See Also**
- ["Introduction to :MEASure Commands"](#) on page 490
 - [":MEASure:SOURce"](#) on page 531
 - [":MEASure:NWIDth"](#) on page 516
 - [":MEASure:PWIDth"](#) on page 524
 - [":MEASure:FREQuency"](#) on page 512

Example Code • ["Example Code"](#) on page 532

:MEASure:PHASe

N (see [page 1384](#))

Command Syntax :MEASure:PHASe [<source1>] [,<source2>]

<source1>, <source2> ::= {CHANnel<n> | FUNction<m> | MATH<m> | WMEMory<r>}

<n> ::= 1 to (# analog channels) in NR1 format

<m> ::= 1 to (# math functions) in NR1 format

<r> ::= 1 to (# ref waveforms) in NR1 format

The :MEASure:PHASe command places the instrument in the continuous measurement mode and starts a phase measurement.

Query Syntax :MEASure:PHASe? [<source1>] [,<source2>]

The :MEASure:PHASe? query measures and returns the phase between the specified sources.

A phase measurement is a combination of the period and delay measurements. First, the period is measured on source1. Then the delay is measured between source1 and source2. The edges used for delay are the source1 rising edge used for the period measurement closest to the horizontal reference and the rising edge on source 2. See :MEASure:DELAy for more detail on selecting the 2nd edge.

The phase is calculated as follows:

$$\text{phase} = (\text{delay} / \text{period of input 1}) \times 360$$

Return Format <value><NL>

<value> ::= the phase angle value in degrees in NR3 format

- See Also**
- ["Introduction to :MEASure Commands"](#) on page 490
 - [":MEASure:DELAy"](#) on page 502
 - [":MEASure:PERiod"](#) on page 520
 - [":MEASure:SOURce"](#) on page 531

:MEASure:PPULses

N (see [page 1384](#))

Command Syntax :MEASure:PPULses [<source>]

<source> ::= {CHANnel<n> | FUNction<m> | MATH<m> | WMEMory<r>}

<n> ::= 1 to (# analog channels) in NR1 format

<m> ::= 1 to (# math functions) in NR1 format

<r> ::= 1 to (# ref waveforms) in NR1 format

The :MEASure:PPULses command installs a rising pulse count measurement on screen. If the optional source parameter is not specified, the current source is measured.

NOTE

This command is not available if the source is FFT (Fast Fourier Transform).

Query Syntax :MEASure:PPULses? [<source>]

The :MEASure:PPULses? query measures and returns the on-screen rising pulse count.

Return Format <value><NL>

<value> ::= the rising pulse count in NR3 format

- See Also**
- ["Introduction to :MEASure Commands"](#) on page 490
 - [":MEASure:SOURce"](#) on page 531

:MEASure:PREShoot

C (see [page 1384](#))

Command Syntax :MEASure:PREShoot [<source>]

<source> ::= {CHANnel<n> | FUNction<m> | MATH<m> | WMEMory<r>}

<n> ::= 1 to (# analog channels) in NR1 format

<r> ::= 1 to (# ref waveforms) in NR1 format

The :MEASure:PREShoot command installs a screen measurement and starts a preshoot measurement. If the optional source parameter is specified, the current source is modified.

Query Syntax :MEASure:PREShoot? [<source>]

The :MEASure:PREShoot? query measures and returns the preshoot of the edge closest to the trigger, displayed on the screen. The method used to determine preshoot is to make three different vertical value measurements: Vtop, Vbase, and either Vmin or Vmax, depending on whether the edge is rising or falling.

For a rising edge:

$$\text{preshoot} = ((V_{\text{min}} - V_{\text{base}}) / (V_{\text{top}} - V_{\text{base}})) \times 100$$

For a falling edge:

$$\text{preshoot} = ((V_{\text{max}} - V_{\text{top}}) / (V_{\text{top}} - V_{\text{base}})) \times 100$$

Vtop and Vbase are taken from the normal histogram of all waveform vertical values. The extremum of Vmax or Vmin is taken from the waveform interval right before the chosen edge, halfway back to the previous edge. This more restricted definition is used instead of the normal one, because it is likely that a signal may have more overshoot than preshoot, and the normal extremum would then be dominated by the overshoot of the preceding edge.

Return Format <value><NL>

<value> ::= the percent of preshoot of the selected waveform
in NR3 format

- See Also**
- ["Introduction to :MEASure Commands"](#) on page 490
 - [":MEASure:SOURce"](#) on page 531
 - [":MEASure:VMIN"](#) on page 547
 - [":MEASure:VMAX"](#) on page 546
 - [":MEASure:VTOP"](#) on page 552
 - [":MEASure:VBASe"](#) on page 545

:MEASure:PWIDth

C (see [page 1384](#))

Command Syntax :MEASure:PWIDth [<source>]

<source> ::= {<digital channels> | CHANnel<n> | FUNction<m> | MATH<m>
| WMEMory<r>}

<digital channels> ::= DIGital<d> for the MSO models

<d> ::= 0 to (# digital channels - 1) in NR1 format

<n> ::= 1 to (# of analog channels) in NR1 format

<m> ::= 1 to (# math functions) in NR1 format

<r> ::= 1 to (# ref waveforms) in NR1 format

The :MEASure:PWIDth command installs a screen measurement and starts the positive pulse width measurement. If the optional source parameter is specified, the current source is modified.

NOTE

This command is not available if the source is FFT (Fast Fourier Transform).

Query Syntax :MEASure:PWIDth? [<source>]

The :MEASure:PWIDth? query measures and outputs the width of the displayed positive pulse closest to the trigger reference. Pulse width is measured at the midpoint of the upper and lower thresholds.

IF the edge on the screen closest to the trigger is falling:

THEN width = (time at trailing falling edge - time at leading rising edge)

ELSE width = (time at leading falling edge - time at leading rising edge)

Return Format <value><NL>

<value> ::= width of positive pulse in seconds in NR3 format

- See Also**
- ["Introduction to :MEASure Commands"](#) on page 490
 - [":MEASure:SOURce"](#) on page 531
 - [":MEASure:NWIDth"](#) on page 516
 - [":MEASure:PERiod"](#) on page 520

:MEASure:RESults

N (see [page 1384](#))

Query Syntax :MEASure:RESults?

The :MEASure:RESults? query returns the results of the continuously displayed measurements. The response to the MEASure:RESults? query is a list of comma-separated values.

If more than one measurement is running continuously, the :MEASure:RESults return values are duplicated for each continuous measurement from the first to last (top to bottom) result displayed. Each result returned is separated from the previous result by a comma. There is a maximum of 10 continuous measurements that can be continuously displayed at a time.

When no quick measurements are installed, the :MEASure:RESults? query returns nothing (empty string). When the count for any of the measurements is 0, the value of infinity (9.9E+37) is returned for the min, max, mean, and standard deviation.

Return Format <result_list><NL>

<result_list> ::= comma-separated list of measurement results

The following shows the order of values received for a single measurement if :MEASure:STATistics is set to ON.

Measureme nt label	current	min	max	mean	std dev	count
-----------------------	---------	-----	-----	------	---------	-------

Measurement label, current, min, max, mean, std dev, and count are only returned if :MEASure:STATistics is ON.

If :MEASure:STATistics is set to CURRent, MIN, MAX, MEAN, STDDev, or COUNT only that particular statistic value is returned for each measurement that is on.

- See Also**
- ["Introduction to :MEASure Commands"](#) on page 490
 - [":MEASure:STATistics"](#) on page 533

Example Code

```
' This program shows the InfiniiVision oscilloscopes' measurement
' statistics commands.
' -----
```

Option Explicit

```
Public myMgr As VisaComLib.ResourceManager
Public myScope As VisaComLib.FormattedIO488
Public varQueryResult As Variant
Public strQueryResult As String
```

```
Private Declare Sub Sleep Lib "kernel32" (ByVal dwMilliseconds As Long)
```

```

Sub Main()

    On Error GoTo VisaComError

    ' Create the VISA COM I/O resource.
    Set myMgr = New VisaComLib.ResourceManager
    Set myScope = New VisaComLib.FormattedIO488
    Set myScope.IO = myMgr.Open("TCPIP0::130.29.70.228::inst0::INSTR")

    ' Initialize.
    myScope.IO.Clear ' Clear the interface.
    myScope.WriteString "*RST" ' Reset to the defaults.
    myScope.WriteString "*CLS" ' Clear the status data structures.
    myScope.WriteString ":AUToscale"

    ' Install some measurements.
    myScope.WriteString ":MEASure:SOURce CHANnel1" ' Input source.

    Dim MeasurementArray(3) As String
    MeasurementArray(0) = "FREQuency"
    MeasurementArray(1) = "DUTYcycle"
    MeasurementArray(2) = "VAMPlitude"
    MeasurementArray(3) = "VPP"
    Dim Measurement As Variant

    For Each Measurement In MeasurementArray
        myScope.WriteString ":MEASure:" + Measurement
        myScope.WriteString ":MEASure:" + Measurement + "?"
        varQueryResult = myScope.ReadNumber ' Read measurement value.
        Debug.Print Measurement + ": " + FormatNumber(varQueryResult, 4)
    Next

    myScope.WriteString ":MEASure:STATistics:RESet" ' Reset stats.
    Sleep 5000 ' Wait for 5 seconds.

    ' Select the statistics results type.
    Dim ResultsTypeArray(6) As String
    ResultsTypeArray(0) = "CURRent"
    ResultsTypeArray(1) = "MINimum"
    ResultsTypeArray(2) = "MAXimum"
    ResultsTypeArray(3) = "MEAN"
    ResultsTypeArray(4) = "STDDev"
    ResultsTypeArray(5) = "COUNT"
    ResultsTypeArray(6) = "ON" ' All results.
    Dim ResultType As Variant

    Dim ResultsList()

    Dim ValueColumnArray(6) As String
    ValueColumnArray(0) = "Meas_Lbl"
    ValueColumnArray(1) = "Current"
    ValueColumnArray(2) = "Min"
    ValueColumnArray(3) = "Max"
    ValueColumnArray(4) = "Mean"
    ValueColumnArray(5) = "Std_Dev"
    ValueColumnArray(6) = "Count"

```

```

Dim ValueColumn As Variant

For Each ResultType In ResultsTypeArray
    myScope.WriteString ":MEASure:STATistics " + ResultType

    ' Get the statistics results.
    Dim intCounter As Integer
    intCounter = 0
    myScope.WriteString ":MEASure:RESults?"
    ResultsList() = myScope.ReadList

    For Each Measurement In MeasurementArray

        If ResultType = "ON" Then ' All statistics.

            For Each ValueColumn In ValueColumnArray
                If VarType(ResultsList(intCounter)) <> vbString Then
                    Debug.Print "Measure statistics result CH1, " + _
                        Measurement + ", "; ValueColumn + ": " + _
                        FormatNumber(ResultsList(intCounter), 4)

                Else ' Result is a string (e.g., measurement label).
                    Debug.Print "Measure statistics result CH1, " + _
                        Measurement + ", "; ValueColumn + ": " + _
                        ResultsList(intCounter)

                End If

                intCounter = intCounter + 1

            Next

        Else ' Specific statistic (e.g., Current, Max, Min, etc.).

            Debug.Print "Measure statistics result CH1, " + _
                Measurement + ", "; ResultType + ": " + _
                FormatNumber(ResultsList(intCounter), 4)

            intCounter = intCounter + 1

        End If

    Next

Next

Exit Sub

VisaComError:
    MsgBox "VISA COM Error:" + vbCrLf + Err.Description

End Sub

```

:MEASure:RISetime

C (see [page 1384](#))

Command Syntax :MEASure: RISetime [<source>]

<source> ::= {CHANnel<n> | FUNction<m> | MATH<m> | WMEMory<r>}

<n> ::= 1 to (# analog channels) in NR1 format

<m> ::= 1 to (# math functions) in NR1 format

<r> ::= 1 to (# ref waveforms) in NR1 format

The :MEASure:RISetime command installs a screen measurement and starts a rise-time measurement. If the optional source parameter is specified, the current source is modified.

NOTE

This command is not available if the source is FFT (Fast Fourier Transform).

Query Syntax :MEASure: RISetime? [<source>]

The :MEASure:RISetime? query measures and outputs the rise time of the displayed rising (positive-going) edge closest to the trigger reference. For maximum measurement accuracy, set the sweep speed as fast as possible while leaving the leading edge of the waveform on the display. The rise time is determined by measuring the time at the lower threshold of the rising edge and the time at the upper threshold of the rising edge, then calculating the rise time with the following formula:

$$\text{rise time} = \text{time at upper threshold} - \text{time at lower threshold}$$

Return Format <value><NL>

<value> ::= rise time in seconds in NR3 format

- See Also**
- ["Introduction to :MEASure Commands"](#) on page 490
 - [":MEASure:SOURce"](#) on page 531
 - [":MEASure:FALLtime"](#) on page 511

:MEASure:SDEVIation

N (see [page 1384](#))

Command Syntax :MEASure:SDEVIation [<source>]
 <source> ::= {CHANnel<n> | FUNction<m> | MATH<m> | WMEMory<r>}
 <n> ::= 1-2 or 1-4 (# of analog channels) in NR1 format
 <m> ::= 1 to (# math functions) in NR1 format
 <r> ::= 1 to (# ref waveforms) in NR1 format

NOTE

This ":MEASure:VRMS DISPlay, AC" command is the preferred syntax for making standard deviation measurements.

The :MEASure:SDEVIation command installs a screen measurement and starts std deviation measurement. If the optional source parameter is specified, the current source is modified.

NOTE

This command is not available if the source is FFT (Fast Fourier Transform).

Query Syntax :MEASure:SDEVIation? [<source>]

The :MEASure:SDEVIation? query measures and outputs the std deviation of the selected waveform. The oscilloscope computes the std deviation on all displayed data points.

Return Format <value><NL>
 <value> ::= calculated std deviation value in NR3 format

- See Also**
- ["Introduction to :MEASure Commands"](#) on page 490
 - [":MEASure:VRMS"](#) on page 550
 - [":MEASure:SOURce"](#) on page 531

:MEASure:SHOW

N (see [page 1384](#))

Command Syntax :MEASure:SHOW <on_off>
 <on_off> ::= {{0 | OFF} | {1 | ON}}

The :MEASure:SHOW command enables markers for tracking measurements on the display.

Query Syntax :MEASure:SHOW?

The :MEASure:SHOW? query returns the current state of the markers.

This can return OFF when :MARKer:MODE selects a mode other than MEASurement.

Return Format <on_off><NL>
 <on_off> ::= {1 | 0}

- See Also**
- ["Introduction to :MEASure Commands"](#) on page 490
 - [":MARKer:MODE"](#) on page 457

:MEASure:SOURce

C (see [page 1384](#))

Command Syntax :MEASure:SOURce <source1>[,<source2>]

```
<source1>,<source2> ::= {<digital channels> | CHANnel<n> | FUNction
                        | MATH | WMEMory<r> | EXTErnal}
```

```
<digital channels> ::= DIGital<d> for the MSO models
```

```
<n> ::= 1 to (# of analog channels) in NR1 format
```

```
<r> ::= 1-2 in NR1 format
```

```
<d> ::= 0 to (# digital channels - 1) in NR1 format
```

The :MEASure:SOURce command sets the default sources for measurements. The specified sources are used as the sources for the MEASure subsystem commands if the sources are not explicitly set with the command.

If a source is specified for any measurement, the current source is changed to this new value.

If :MARKer:MODE is set to OFF or MANual, setting :MEASure:SOURce to CHANnel<n>, FUNction, or MATH will also set :MARKer:X1Y1source to source1 and :MARKer:X2Y2source to source2.

EXTErnal is only a valid source for the counter measurement (and <source1>).

Query Syntax :MEASure:SOURce?

The :MEASure:SOURce? query returns the current source selections. If source2 is not specified, the query returns "NONE" for source2. If all channels are off, the query returns "NONE,NONE". Source2 only applies to :MEASure:DELAy and :MEASure:PHASe measurements.

NOTE

MATH is an alias for FUNction. The query will return FUNC if the source is FUNction or MATH.

Return Format <source1>,<source2><NL>

```
<source1>,<source2> ::= {<digital channels> | CHAN<n> | FUNC | WMMW<r>
                        | EXT | NONE}
```

- See Also:**
- ["Introduction to :MEASure Commands"](#) on page 490
 - [":MARKer:MODE"](#) on page 457
 - [":MARKer:X1Y1source"](#) on page 460
 - [":MARKer:X2Y2source"](#) on page 463
 - [":MEASure:DELAy"](#) on page 502
 - [":MEASure:PHASe"](#) on page 521

Example Code

```

' MEASURE - The commands in the MEASURE subsystem are used to make
' measurements on displayed waveforms.
myScope.WriteString ":MEASURE:SOURCE CHANNEL1" ' Source to measure.
myScope.WriteString ":MEASURE:FREQUENCY?" ' Query for frequency.
varQueryResult = myScope.ReadNumber ' Read frequency.
MsgBox "Frequency:" + vbCrLf _
    + FormatNumber(varQueryResult / 1000, 4) + " kHz"
myScope.WriteString ":MEASURE:DUTYCYCLE?" ' Query for duty cycle.
varQueryResult = myScope.ReadNumber ' Read duty cycle.
MsgBox "Duty cycle:" + vbCrLf _
    + FormatNumber(varQueryResult, 3) + "%"
myScope.WriteString ":MEASURE:RISETIME?" ' Query for risetime.
varQueryResult = myScope.ReadNumber ' Read risetime.
MsgBox "Risetime:" + vbCrLf _
    + FormatNumber(varQueryResult * 1000000, 4) + " us"
myScope.WriteString ":MEASURE:VPP?" ' Query for Pk to Pk voltage.
varQueryResult = myScope.ReadNumber ' Read VPP.
MsgBox "Peak to peak voltage:" + vbCrLf _
    + FormatNumber(varQueryResult, 4) + " V"
myScope.WriteString ":MEASURE:VMAX?" ' Query for Vmax.
varQueryResult = myScope.ReadNumber ' Read Vmax.
MsgBox "Maximum voltage:" + vbCrLf _
    + FormatNumber(varQueryResult, 4) + " V"

```

See complete example programs at: [Chapter 42](#), “Programming Examples,” starting on page 1393

:MEASure:STATistics

N (see [page 1384](#))

Command Syntax :MEASure:STATistics <type>

```
<type> ::= {{ON | 1} | CURRent | MINimum | MAXimum | MEAN | STDev
          | COUNT}
```

The :MEASure:STATistics command determines the type of information returned by the :MEASure:RESults? query. ON means all the statistics are on.

Query Syntax :MEASure:STATistics?

The :MEASure:STATistics? query returns the current statistics mode.

Return Format <type><NL>

```
<type> ::= {ON | CURR | MIN | MAX | MEAN | STDD | COUN}
```

- See Also**
- ["Introduction to :MEASure Commands"](#) on page 490
 - [":MEASure:RESults"](#) on page 525
 - [":MEASure:STATistics:DISPlay"](#) on page 534
 - [":MEASure:STATistics:RESet"](#) on page 537
 - [":MEASure:STATistics:INCRement"](#) on page 535

Example Code • ["Example Code"](#) on page 525

:MEASure:STATistics:DISPlay

N (see [page 1384](#))

Command Syntax :MEASure:STATistics:DISPlay {{0 | OFF} | {1 | ON}}

The :MEASure:STATistics:DISPlay command disables or enables the display of the measurement statistics.

Query Syntax :MEASure:STATistics:DISPlay?

The :MEASure:STATistics:DISPlay? query returns the state of the measurement statistics display.

Return Format {0 | 1}<NL>

- See Also**
- ["Introduction to :MEASure Commands"](#) on page 490
 - [":MEASure:RESults"](#) on page 525
 - [":MEASure:STATistics"](#) on page 533
 - [":MEASure:STATistics:MCOunt"](#) on page 536
 - [":MEASure:STATistics:RESet"](#) on page 537
 - [":MEASure:STATistics:INCRement"](#) on page 535
 - [":MEASure:STATistics:RSDeviation"](#) on page 538

:MEASure:STATistics:INCRement

N (see [page 1384](#))

Command Syntax :MEASure:STATistics:INCRement

This command updates the statistics once (incrementing the count by one) using the current measurement values. It corresponds to the front panel **Increment Statistics** softkey in the Measurement Statistics Menu. This command lets you, for example, gather statistics over multiple pulses captured in a single acquisition. To do this, change the horizontal position and enter the command for each new pulse that is measured.

This command is only allowed when the oscilloscope is stopped and quick measurements are on.

The command is allowed in segmented acquisition mode even though the corresponding front panel softkey is not available.

- See Also**
- ["Introduction to :MEASure Commands"](#) on page 490
 - [":MEASure:STATistics"](#) on page 533
 - [":MEASure:STATistics:DISPlay"](#) on page 534
 - [":MEASure:STATistics:RESet"](#) on page 537
 - [":MEASure:RESults"](#) on page 525

:MEASure:STATistics:MCOunt

N (see [page 1384](#))

Command Syntax :MEASure:STATistics:MCOunt <setting>
 <setting> ::= {INFinite | <count>}
 <count> ::= 2 to 2000 in NR1 format

The :MEASure:STATistics:MCOunt command specifies the maximum number of values used when calculating measurement statistics.

Query Syntax :MEASure:STATistics:MCOunt?

The :MEASure:STATistics:MCOunt? query returns the current measurement statistics max count setting.

Return Format <setting><NL>
 <setting> ::= {INF | <count>}
 <count> ::= 2 to 2000

- See Also**
- ["Introduction to :MEASure Commands"](#) on page 490
 - [":MEASure:RESults"](#) on page 525
 - [":MEASure:STATistics"](#) on page 533
 - [":MEASure:STATistics:DISPlay"](#) on page 534
 - [":MEASure:STATistics:RSDeviation"](#) on page 538
 - [":MEASure:STATistics:RESet"](#) on page 537
 - [":MEASure:STATistics:INCRement"](#) on page 535

:MEASure:STATistics:RESet

N (see [page 1384](#))

Command Syntax :MEASure:STATistics:RESet

This command resets the measurement statistics, zeroing the counts.

Note that the measurement (statistics) configuration is not deleted.

- See Also**
- ["Introduction to :MEASure Commands"](#) on page 490
 - [":MEASure:STATistics"](#) on page 533
 - [":MEASure:STATistics:DISPlay"](#) on page 534
 - [":MEASure:RESults"](#) on page 525
 - [":MEASure:STATistics:INCRement"](#) on page 535

- Example Code**
- ["Example Code"](#) on page 525

:MEASure:STATistics:RSDeviation

N (see [page 1384](#))

Command Syntax :MEASure:STATistics:RSDeviation {{0 | OFF} | {1 | ON}}

The :MEASure:STATistics:RSDeviation command disables or enables relative standard deviations, that is, standard deviation/mean, in the measurement statistics.

Query Syntax :MEASure:STATistics:RSDeviation?

The :MEASure:STATistics:RSDeviation? query returns the current relative standard deviation setting.

Return Format {0 | 1}<NL>

- See Also**
- ["Introduction to :MEASure Commands"](#) on page 490
 - [":MEASure:RESults"](#) on page 525
 - [":MEASure:STATistics"](#) on page 533
 - [":MEASure:STATistics:DISPlay"](#) on page 534
 - [":MEASure:STATistics:MCOunt"](#) on page 536
 - [":MEASure:STATistics:RESet"](#) on page 537
 - [":MEASure:STATistics:INCRement"](#) on page 535

:MEASure:TEDGe

N (see [page 1384](#))

Query Syntax :MEASure:TEDGe? <slope><occurrence>[,<source>]

<slope> ::= direction of the waveform. A rising slope is indicated by a space or plus sign (+). A falling edge is indicated by a minus sign (-).

<occurrence> ::= the transition to be reported. If the occurrence number is one, the first crossing from the left screen edge is reported. If the number is two, the second crossing is reported, etc.

<source> ::= {<digital channels> | CHANnel<n> | FUNction<m> | MATH<m> | WMEMory<r>}

<digital channels> ::= DIGital<d> for the MSO models

<n> ::= 1 to (# of analog channels) in NR1 format

<m> ::= 1 to (# math functions) in NR1 format

<r> ::= 1 to (# ref waveforms) in NR1 format

<d> ::= 0 to (# digital channels - 1) in NR1 format

When the :MEASure:TEDGe query is sent, the displayed signal is searched for the specified transition. The time interval between the trigger event and this occurrence is returned as the response to the query. The sign of the slope selects a rising (+) or falling (-) edge. If no sign is specified for the slope, it is assumed to be the rising edge.

The magnitude of occurrence defines the occurrence to be reported. For example, +3 returns the time for the third time the waveform crosses the midpoint threshold in the positive direction. Once this crossing is found, the oscilloscope reports the time at that crossing in seconds, with the trigger point (time zero) as the reference.

If the specified crossing cannot be found, the oscilloscope reports +9.9E+37. This value is returned if the waveform does not cross the specified vertical value, or if the waveform does not cross the specified vertical value for the specific number of times in the direction specified.

You can make delay and phase measurements using the MEASure:TEDGe command:

Delay = time at the nth rising or falling edge of the channel - time at the same edge of another channel

Phase = (delay between channels / period of channel) x 360

For an example of making a delay and phase measurement, see "[:MEASure:TEDGe Code](#)" on page 540.

If the optional source parameter is specified, the current source is modified.

NOTE

This query is not available if the source is FFT (Fast Fourier Transform).

Return Format <value><NL>

<value> ::= time in seconds of the specified transition in NR3 format

**:MEASure:TEDGe
Code**

```
' Make a delay measurement between channel 1 and 2.
Dim dblChan1Edge1 As Double
Dim dblChan2Edge1 As Double
Dim dblChan1Edge2 As Double
Dim dblDelay As Double
Dim dblPeriod As Double
Dim dblPhase As Double

' Query time at 1st rising edge on ch1.
myScope.WriteString ":MEASURE:TEDGE? +1, CHAN1"

' Read time at edge 1 on ch 1.
dblChan1Edge1 = myScope.ReadNumber

' Query time at 1st rising edge on ch2.
myScope.WriteString ":MEASURE:TEDGE? +1, CHAN2"

' Read time at edge 1 on ch 2.
dblChan2Edge1 = myScope.ReadNumber

' Calculate delay time between ch1 and ch2.
dblDelay = dblChan2Edge1 - dblChan1Edge1

' Write calculated delay time to screen.
MsgBox "Delay = " + vbCrLf + CStr(dblDelay)

' Make a phase difference measurement between channel 1 and 2.
' Query time at 1st rising edge on ch1.
myScope.WriteString ":MEASURE:TEDGE? +2, CHAN1"

' Read time at edge 2 on ch 1.
dblChan1Edge2 = myScope.ReadNumber

' Calculate period of ch 1.
dblPeriod = dblChan1Edge2 - dblChan1Edge1

' Calculate phase difference between ch1 and ch2.
dblPhase = (dblDelay / dblPeriod) * 360
MsgBox "Phase = " + vbCrLf + CStr(dblPhase)
```

See complete example programs at: [Chapter 42](#), "Programming Examples," starting on page 1393

- See Also**
- ["Introduction to :MEASure Commands"](#) on page 490
 - [":MEASure:TVALue"](#) on page 541
 - [":MEASure:VTIME"](#) on page 551

:MEASure:TVALue

C (see [page 1384](#))

Query Syntax :MEASure:TVALue? <value>, [<slope>]<occurrence>[,<source>]

<value> ::= the vertical value that the waveform must cross. The value can be volts or a math function value such as dB, Vs, or V/s.

<slope> ::= direction of the waveform. A rising slope is indicated by a plus sign (+). A falling edge is indicated by a minus sign (-).

<occurrence> ::= the transition to be reported. If the occurrence number is one, the first crossing is reported. If the number is two, the second crossing is reported, etc.

<source> ::= {CHANnel<n> | FUNCTION<m> | MATH<m> | WMemory<r>}

<n> ::= 1 to (# analog channels) in NR1 format

<m> ::= 1 to (# math functions) in NR1 format

<r> ::= 1 to (# ref waveforms) in NR1 format

When the :MEASure:TVALue? query is sent, the displayed signal is searched for the specified value level and transition. The time interval between the trigger event and this defined occurrence is returned as the response to the query.

The specified value can be negative or positive. To specify a negative value, use a minus sign (-). The sign of the slope selects a rising (+) or falling (-) edge. If no sign is specified for the slope, it is assumed to be the rising edge.

The magnitude of the occurrence defines the occurrence to be reported. For example, +3 returns the time for the third time the waveform crosses the specified value level in the positive direction. Once this value crossing is found, the oscilloscope reports the time at that crossing in seconds, with the trigger point (time zero) as the reference.

If the specified crossing cannot be found, the oscilloscope reports +9.9E+37. This value is returned if the waveform does not cross the specified value, or if the waveform does not cross the specified value for the specified number of times in the direction specified.

If the optional source parameter is specified, the current source is modified.

NOTE

This query is not available if the source is FFT (Fast Fourier Transform).

Return Format <value><NL>

<value> ::= time in seconds of the specified value crossing in
NR3 format

- See Also**
- ["Introduction to :MEASure Commands"](#) on page 490
 - [":MEASure:TEDGe"](#) on page 539
 - [":MEASure:VTIMe"](#) on page 551

:MEASure:VAMplitude

C (see [page 1384](#))

Command Syntax :MEASure:VAMplitude [<source>]
 <source> ::= {CHANnel<n> | FUNction<m> | MATH<m> | WMEMory<r>}
 <n> ::= 1 to (# analog channels) in NR1 format
 <m> ::= 1 to (# math functions) in NR1 format
 <r> ::= 1 to (# ref waveforms) in NR1 format

The :MEASure:VAMplitude command installs a screen measurement and starts a vertical amplitude measurement. If the optional source parameter is specified, the current source is modified.

Query Syntax :MEASure:VAMplitude? [<source>]

The :MEASure:VAMplitude? query measures and returns the vertical amplitude of the waveform. To determine the amplitude, the instrument measures Vtop and Vbase, then calculates the amplitude as follows:

$$\text{vertical amplitude} = V_{\text{top}} - V_{\text{base}}$$

Return Format <value><NL>
 <value> ::= the amplitude of the selected waveform in NR3 format

- See Also**
- ["Introduction to :MEASure Commands"](#) on page 490
 - [":MEASure:SOURce"](#) on page 531
 - [":MEASure:VBASe"](#) on page 545
 - [":MEASure:VTOp"](#) on page 552
 - [":MEASure:VPP"](#) on page 548

:MEASure:VAverage

C (see [page 1384](#))

Command Syntax :MEASure:VAverage [<interval>][,<source>]

<interval> ::= {CYCLe | DISPlay}

<source> ::= {CHANnel<n> | FUNCTION<m> | MATH<m> | FFT | WMemory<r>}

<n> ::= 1-2 or 1-4 (# of analog channels) in NR1 format

<m> ::= 1 to (# math functions) in NR1 format

<r> ::= 1 to (# ref waveforms) in NR1 format

The :MEASure:VAverage command installs a screen measurement and starts an average value measurement.

The <interval> option lets you specify the measurement interval: either an integral number of cycles, or the full screen. If <interval> is not specified, DISPlay is implied.

If the optional source parameter is specified, the current source is modified.

Query Syntax :MEASure:VAverage? [<interval>][,<source>]

The :MEASure:VAverage? query returns the average value of an integral number of periods of the signal.

Return Format <value><NL>

<value> ::= calculated average value in NR3 format

- See Also**
- ["Introduction to :MEASure Commands"](#) on page 490
 - [":MEASure:SOURce"](#) on page 531

:MEASure:VBASe

C (see [page 1384](#))

Command Syntax :MEASure:VBASe [<source>]
 <source> ::= {CHANnel<n> | FUNCTION<m> | MATH<m> | WMEMory<r>}
 <n> ::= 1 to (# analog channels) in NR1 format
 <m> ::= 1 to (# math functions) in NR1 format
 <r> ::= 1 to (# ref waveforms) in NR1 format

The :MEASure:VBASe command installs a screen measurement and starts a waveform base value measurement. If the optional source parameter is specified, the current source is modified.

NOTE

This command is not available if the source is FFT (Fast Fourier Transform).

Query Syntax :MEASure:VBASe? [<source>]

The :MEASure:VBASe? query returns the vertical value at the base of the waveform. The base value of a pulse is normally not the same as the minimum value.

Return Format <base_voltage><NL>
 <base_voltage> ::= value at the base of the selected waveform in NR3 format

- See Also**
- ["Introduction to :MEASure Commands"](#) on page 490
 - [":MEASure:SOURce"](#) on page 531
 - [":MEASure:VTOP"](#) on page 552
 - [":MEASure:VAMPLitude"](#) on page 543
 - [":MEASure:VMIN"](#) on page 547

:MEASure:VMAX

C (see [page 1384](#))

Command Syntax :MEASure:VMAX [<source>]

<source> ::= {CHANnel<n> | FUNction<m> | MATH<m> | FFT | WMEMory<r>}

<n> ::= 1-2 or 1-4 (# of analog channels) in NR1 format

<m> ::= 1 to (# math functions) in NR1 format

<r> ::= 1 to (# ref waveforms) in NR1 format

The :MEASure:VMAX command installs a screen measurement and starts a maximum vertical value measurement. If the optional source parameter is specified, the current source is modified.

Query Syntax :MEASure:VMAX? [<source>]

The :MEASure:VMAX? query measures and outputs the maximum vertical value present on the selected waveform.

Return Format <value><NL>

<value> ::= maximum vertical value of the selected waveform in
NR3 format

- See Also**
- ["Introduction to :MEASure Commands"](#) on page 490
 - [":MEASure:SOURce"](#) on page 531
 - [":MEASure:VMIN"](#) on page 547
 - [":MEASure:VPP"](#) on page 548
 - [":MEASure:VTOP"](#) on page 552

:MEASure:VMIN

C (see [page 1384](#))

Command Syntax :MEASure:VMIN [<source>]

<source> ::= {CHANnel<n> | FUNCTION<m> | MATH<m> | FFT | WMemory<r>}

<n> ::= 1 to (# analog channels) in NR1 format

<m> ::= 1 to (# math functions) in NR1 format

<r> ::= 1 to (# ref waveforms) in NR1 format

The :MEASure:VMIN command installs a screen measurement and starts a minimum vertical value measurement. If the optional source parameter is specified, the current source is modified.

Query Syntax :MEASure:VMIN? [<source>]

The :MEASure:VMIN? query measures and outputs the minimum vertical value present on the selected waveform.

Return Format <value><NL>

<value> ::= minimum vertical value of the selected waveform in
NR3 format

- See Also**
- ["Introduction to :MEASure Commands"](#) on page 490
 - [":MEASure:SOURce"](#) on page 531
 - [":MEASure:VBASe"](#) on page 545
 - [":MEASure:VMAX"](#) on page 546
 - [":MEASure:VPP"](#) on page 548

:MEASure:VPP

C (see [page 1384](#))

Command Syntax :MEASure:VPP [<source>]
 <source> ::= {CHANnel<n> | FUNCTION<m> | MATH<m> | FFT | WMemory<r>}
 <n> ::= 1 to (# analog channels) in NR1 format
 <m> ::= 1 to (# math functions) in NR1 format
 <r> ::= 1 to (# ref waveforms) in NR1 format

The :MEASure:VPP command installs a screen measurement and starts a vertical peak-to-peak measurement. If the optional source parameter is specified, the current source is modified.

Query Syntax :MEASure:VPP? [<source>]

The :MEASure:VPP? query measures the maximum and minimum vertical value for the selected source, then calculates the vertical peak-to-peak value and returns that value. The peak-to-peak value (Vpp) is calculated with the following formula:

$$V_{pp} = V_{max} - V_{min}$$

Vmax and Vmin are the vertical maximum and minimum values present on the selected source.

Return Format <value><NL>
 <value> ::= vertical peak to peak value in NR3 format

- See Also**
- ["Introduction to :MEASure Commands"](#) on page 490
 - [":MEASure:SOURce"](#) on page 531
 - [":MEASure:VMAX"](#) on page 546
 - [":MEASure:VMIN"](#) on page 547
 - [":MEASure:VAMPLitude"](#) on page 543

:MEASure:VRATio

N (see [page 1384](#))

Command Syntax :MEASure:VRATio [<interval>] [,<source1>] [,<source2>]
 <interval> ::= {CYCLe | DISPlay}
 <source1,2> ::= {CHANnel<n> | FUNction<m> | MATH<m> | WMEMory<r>}
 <n> ::= 1 to (# analog channels) in NR1 format
 <m> ::= 1 to (# math functions) in NR1 format
 <r> ::= 1 to (# ref waveforms) in NR1 format

The :MEASure:VRATio command installs a ratio measurement on screen. Ratio measurements show the ratio of the ACRMS value of source1 to that of source2, expressed in dB.

The <interval> option lets you specify the measurement interval: either an integral number of cycles, or the full screen. If <interval> is not specified, DISPlay is implied.

NOTE

This command is not available if the source is FFT (Fast Fourier Transform).

Query Syntax :MEASure:VRATio? [<interval>] [<source1>] [,<source2>]

The :MEASure:VRATio? query measures and returns the ratio of AC RMS values of the specified sources expressed as dB.

Return Format <value><NL>
 <value> ::= the ratio value in dB in NR3 format

- See Also**
- ["Introduction to :MEASure Commands"](#) on page 490
 - [":MEASure:VRMS"](#) on page 550
 - [":MEASure:SOURce"](#) on page 531

:MEASure:VRMS

C (see [page 1384](#))

Command Syntax :MEASure:VRMS [<interval>] [, <type>] [, <source>]

<interval> ::= {CYCLe | DISPlay}

<type> ::= {AC | DC}

<source> ::= {CHANnel<n> | FUNCTION<m> | MATH<m> | WMEMory<r>}

<n> ::= 1-2 or 1-4 (# of analog channels) in NR1 format

<m> ::= 1 to (# math functions) in NR1 format

<r> ::= 1 to (# ref waveforms) in NR1 format

The :MEASure:VRMS command installs a screen measurement and starts an RMS value measurement.

The <interval> option lets you specify the measurement interval: either an integral number of cycles, or the full screen. If <interval> is not specified, DISPlay is implied.

The <type> option lets you choose between a DC RMS measurement and an AC RMS measurement. If <type> is not specified, DC is implied.

If the optional source parameter is specified, the current source is modified.

NOTE

This command is not available if the source is FFT (Fast Fourier Transform).

Query Syntax :MEASure:VRMS? [<interval>] [, <type>] [, <source>]

The :MEASure:VRMS? query measures and outputs the RMS measurement value.

Return Format <value><NL>

<value> ::= calculated dc RMS value in NR3 format

- See Also**
- ["Introduction to :MEASure Commands"](#) on page 490
 - [":MEASure:SOURce"](#) on page 531

:MEASure:VTime

N (see [page 1384](#))

Query Syntax :MEASure:VTime? <vtime_argument>[,<source>]

<vtime_argument> ::= time from trigger in seconds

<source> ::= {<digital channels> | CHANnel<n> | FUNction<m> | MATH<m>
| FFT | WMEMory<r>}

<digital channels> ::= DIGital<d> for the MSO models

<d> ::= 0 to (# digital channels - 1) in NR1 format

<n> ::= 1 to (# of analog channels) in NR1 format

<m> ::= 1 to (# math functions) in NR1 format

<r> ::= 1 to (# ref waveforms) in NR1 format

The :MEASure:VTime? query returns the vertical value at a specified horizontal value on the source specified (see also :MEASure:SOURce). The specified horizontal value must be on the screen; when it is a time value, it is referenced to the trigger event. If the optional source parameter is specified, the measurement source is modified.

NOTE

When the source is an FFT (Fast Fourier Transform) waveform, the <vtime_argument> is a frequency value instead of a time value.

Return Format <value><NL>

<value> ::= vertical value at the specified horizontal location
in NR3 format

- See Also**
- ["Introduction to :MEASure Commands"](#) on page 490
 - [":MEASure:SOURce"](#) on page 531
 - [":MEASure:TEDGe"](#) on page 539
 - [":MEASure:TVALue"](#) on page 541

:MEASure:VTOP

C (see [page 1384](#))

Command Syntax :MEASure:VTOP [<source>]

<source> ::= {CHANnel<n> | FUNction<m> | MATH<m>}

<n> ::= 1-2 or 1-4 (# of analog channels) in NR1 format

<m> ::= 1 to (# math functions) in NR1 format

<r> ::= 1 to (# ref waveforms) in NR1 format

The :MEASure:VTOP command installs a screen measurement and starts a waveform top value measurement.

NOTE

This query is not available if the source is FFT (Fast Fourier Transform).

Query Syntax :MEASure:VTOP? [<source>]

The :MEASure:VTOP? query returns the vertical value at the top of the waveform. The top value of the pulse is normally not the same as the maximum value.

Return Format <value><NL>

<value> ::= vertical value at the top of the waveform in NR3 format

- See Also**
- ["Introduction to :MEASure Commands"](#) on page 490
 - [":MEASure:SOURce"](#) on page 531
 - [":MEASure:VMAX"](#) on page 546
 - [":MEASure:VAMPLitude"](#) on page 543
 - [":MEASure:VBASe"](#) on page 545

:MEASure:WINDow

N (see [page 1384](#))

Command Syntax :MEASure:WINDow <type>

<type> ::= {MAIN | ZOOM | AUTO | GATE}

The :MEASure:WINDow command lets you choose whether measurements are made in the Main window portion of the display, the Zoom window portion of the display (when the zoomed time base is displayed), or gated by the X1 and X2 cursors.

- MAIN – the measurement window is the Main window.
- ZOOM – the measurement window is the lower, Zoom window.
- AUTO – when the zoomed time base is displayed, the measurement is attempted in the lower, Zoom window; if it cannot be made there, or if the zoomed time base is not displayed, the Main window is used.
- GATE – the measurement window is between the X1 and X2 cursors. When the zoomed time base is displayed, the X1 and X2 cursors in the Zoom window portion of the display are used.

Query Syntax :MEASure:WINDow?

The :MEASure:WINDow? query returns the current measurement window setting.

Return Format <type><NL>

<type> ::= {MAIN | ZOOM | AUTO | GATE}

- See Also**
- ["Introduction to :MEASure Commands"](#) on page 490
 - [":MEASure:SOURce"](#) on page 531

:MEASure:XMAX

N (see [page 1384](#))

Command Syntax :MEASure:XMAX [<source>]

<source> ::= {CHANnel<n> | FUNction<m> | MATH<m> | FFT | WMEMory<r>}

<n> ::= 1-2 or 1-4 (# of analog channels) in NR1 format

<m> ::= 1 to (# math functions) in NR1 format

<r> ::= 1 to (# ref waveforms) in NR1 format

The :MEASure:XMAX command installs a screen measurement and starts an X-at-Max-Y measurement on the selected window. If the optional source parameter is specified, the current source is modified.

NOTE

:MEASure:XMAX is an alias for :MEASure:TMAX.

Query Syntax :MEASure:XMAX? [<source>]

The :MEASure:XMAX? query measures and returns the horizontal axis value at which the maximum vertical value occurs. If the optional source is specified, the current source is modified. If all channels are off, the query returns 9.9E+37.

Return Format <value><NL>

<value> ::= horizontal value of the maximum in NR3 format

- See Also**
- ["Introduction to :MEASure Commands"](#) on page 490
 - [":MEASure:XMIN"](#) on page 555
 - [":MEASure:TMAX"](#) on page 1314

:MEASure:XMIN

N (see [page 1384](#))

Command Syntax :MEASure:XMIN [<source>]
 <source> ::= {CHANnel<n> | FUNCTION<m> | MATH<m> | FFT | WMemory<r>}
 <n> ::= 1-2 or 1-4 (# of analog channels) in NR1 format
 <m> ::= 1 to (# math functions) in NR1 format
 <r> ::= 1 to (# ref waveforms) in NR1 format

The :MEASure:XMIN command installs a screen measurement and starts an X-at-Min-Y measurement on the selected window. If the optional source parameter is specified, the current source is modified.

NOTE

:MEASure:XMIN is an alias for :MEASure:TMIN.

Query Syntax :MEASure:XMIN? [<source>]

The :MEASure:XMIN? query measures and returns the horizontal axis value at which the minimum vertical value occurs. If the optional source is specified, the current source is modified. If all channels are off, the query returns 9.9E+37.

Return Format <value><NL>
 <value> ::= horizontal value of the minimum in NR3 format

- See Also**
- ["Introduction to :MEASure Commands"](#) on page 490
 - [":MEASure:XMAX"](#) on page 554
 - [":MEASure:TMIN"](#) on page 1315

23 :MEASure Power Commands

These :MEASure commands are available when the DSOX3PWR power measurements and analysis application is licensed and enabled.

Table 105:MEASure Power Commands Summary

Command	Query	Options and Query Returns
:MEASure:ANGLE [<source1>] [, <source2 >] (see page 561)	:MEASure:ANGLE? [<source1>] [, <source2 >] (see page 561)	<source1>, <source2> ::= {CHANnel<n>} <n> ::= 1 to (# analog channels) in NR1 format <return_value> ::= the power phase angle in degrees in NR3 format
:MEASure:APParent [<source1>] [, <source2 >] (see page 562)	:MEASure:APParent? [<source1>] [, <source2 >] (see page 562)	<source1>, <source2> ::= {CHANnel<n>} <n> ::= 1 to (# analog channels) in NR1 format <return_value> ::= the apparent power value in NR3 format
:MEASure:CPLoss [<source1>] [, <source2 >] (see page 563)	:MEASure:CPLoss? [<source1>] [, <source2 >] (see page 563)	<source1>, <source2> <source1> ::= {FUNction<m> MATH<m>} <source2> ::= {CHANnel<n>} <m> ::= 1 to (# math functions) in NR1 format <n> ::= 1 to (# analog channels) in NR1 format <return_value> ::= the switching loss per cycle watts value in NR3 format

Table 105:MEASure Power Commands Summary (continued)

Command	Query	Options and Query Returns
:MEASure:CRESt [<source>] (see page 564)	:MEASure:CRESt? [<source>] (see page 564)	<source> ::= {CHANnel<n> FUNctIon<m> MATH<m>} <n> ::= 1 to (# analog channels) in NR1 format <m> ::= 1 to (# math functions) in NR1 format <return_value> ::= the crest factor value in NR3 format
:MEASure:EFFiciency (see page 565)	:MEASure:EFFiciency? (see page 565)	<return_value> ::= percent value in NR3 format
:MEASure:ELOSs [<source>] (see page 566)	:MEASure:ELOSs? [<source>] (see page 566)	<source> ::= {CHANnel<n> FUNctIon<m> MATH<m> WMEMory<r>} <n> ::= 1 to (# analog channels) in NR1 format <m> ::= 1 to (# math functions) in NR1 format <r> ::= 1 to (# ref waveforms) in NR1 format <return_value> ::= the energy loss value in NR3 format
:MEASure:FACTOR [<source1>] [,<source2 >] (see page 567)	:MEASure:FACTOR? [<source1>] [,<source2 >] (see page 567)	<source1>, <source2> ::= {CHANnel<n>} <n> ::= 1 to (# analog channels) in NR1 format <return_value> ::= the power factor value in NR3 format
:MEASure:IPower (see page 568)	:MEASure:IPower? (see page 568)	<return_value> ::= the input power value in NR3 format
:MEASure:OFFTime [<source1>] [,<source2 >] (see page 569)	:MEASure:OFFTime? [<source1>] [,<source2 >] (see page 569)	<source1>, <source2> ::= {CHANnel<n>} <n> ::= 1 to (# analog channels) in NR1 format <return_value> ::= the time in seconds in NR3 format
:MEASure:ONTime [<source1>] [,<source2 >] (see page 570)	:MEASure:ONTime? [<source1>] [,<source2 >] (see page 570)	<source1>, <source2> ::= {CHANnel<n>} <n> ::= 1 to (# analog channels) in NR1 format <return_value> ::= the time in seconds in NR3 format
:MEASure:OPower (see page 571)	:MEASure:OPower? (see page 571)	<return_value> ::= the output power value in NR3 format

Table 105:MEASure Power Commands Summary (continued)

Command	Query	Options and Query Returns
:MEASure:PCURrent [<source>] (see page 572)	:MEASure:PCURrent? [<source>] (see page 572)	<source> ::= {CHANnel<n> FUNctIon<m> MATH<m> WMEMemory<r>} <n> ::= 1 to (# analog channels) in NR1 format <m> ::= 1 to (# math functions) in NR1 format <r> ::= 1 to (# ref waveforms) in NR1 format <return_value> ::= the peak current value in NR3 format
:MEASure:PLOSSs [<source>] (see page 573)	:MEASure:PLOSSs? [<source>] (see page 573)	<source> ::= {CHANnel<n> FUNctIon<m> MATH<m> WMEMemory<r>} <n> ::= 1 to (# analog channels) in NR1 format <m> ::= 1 to (# math functions) in NR1 format <r> ::= 1 to (# ref waveforms) in NR1 format <return_value> ::= the power loss value in NR3 format
:MEASure:RDSON [<source1>] [,<source2 >] (see page 574)	:MEASure:RDSON? [<source1>] [,<source2 >] (see page 574)	<source1>, <source2> ::= {CHANnel<n> FUNctIon<m> MATH<m> WMEMemory<r>} <n> ::= 1 to (# analog channels) in NR1 format <m> ::= 1 to (# math functions) in NR1 format <r> ::= 1 to (# ref waveforms) in NR1 format <return_value> ::= the VCE(sat) value in NR3 format
:MEASure:REACTIVE [<source1>] [,<source2 >] (see page 575)	:MEASure:REACTIVE? [<source1>] [,<source2 >] (see page 575)	<source1>, <source2> ::= {CHANnel<n>} <n> ::= 1 to (# analog channels) in NR1 format <return_value> ::= the reactive power value in NR3 format

Table 105:MEASure Power Commands Summary (continued)

Command	Query	Options and Query Returns
:MEASure:REAL [<source>] (see page 576)	:MEASure:REAL? [<source>] (see page 576)	<source> ::= {CHANnel<n> FUNctIon<m> MATH<m>} <n> ::= 1 to (# analog channels) in NR1 format <m> ::= 1 to (# math functions) in NR1 format <return_value> ::= the real power value in NR3 format
:MEASure:RIPple [<source>] (see page 577)	:MEASure:RIPple? [<source>] (see page 577)	<source> ::= {CHANnel<n> FUNctIon<m> MATH<m> WMEMory<r>} <n> ::= 1 to (# analog channels) in NR1 format <m> ::= 1 to (# math functions) in NR1 format <r> ::= 1 to (# ref waveforms) in NR1 format <return_value> ::= the output ripple value in NR3 format
:MEASure:TRESponse [<source>] (see page 578)	:MEASure:TRESponse? [<source>] (see page 578)	<source> ::= {CHANnel<n> FUNctIon<m> MATH<m> WMEMory<r>} <n> ::= 1 to (# analog channels) in NR1 format <m> ::= 1 to (# math functions) in NR1 format <r> ::= 1 to (# ref waveforms) in NR1 format <return_value> ::= time in seconds for the overshoot to settle back into the band in NR3 format
:MEASure:VCESat [<source>] (see page 579)	:MEASure:VCESat? [<source>] (see page 579)	<source> ::= {CHANnel<n> FUNctIon<m> MATH<m> WMEMory<r>} <n> ::= 1 to (# analog channels) in NR1 format <m> ::= 1 to (# math functions) in NR1 format <r> ::= 1 to (# ref waveforms) in NR1 format <return_value> ::= the VCE(sat) value in NR3 format

:MEASure:ANGLE

N (see [page 1384](#))

Command Syntax :MEASure:ANGLE [<source1>] [,<source2>]

<source1>, <source2> ::= {CHANnel<n>}

<n> ::= 1 to (# analog channels) in NR1 format

The :MEASure:ANGLE command installs a power phase angle measurement on screen.

The <source1> parameter is the channel probing voltage and the <source2> parameter is the channel probing current. These sources can also be specified by the :MEASure:SOURce command.

Phase angle is a measure of power quality. In the *power triangle* (the right triangle where $\text{apparent_power}^2 = \text{real_power}^2 + \text{reactive_power}^2$), phase angle is the angle between the apparent power and the real power, indicating the amount of reactive power. Small phase angles equate to less reactive power.

Query Syntax :MEASure:ANGLE? [<source1>] [,<source2>]

The :MEASure:ANGLE query returns the measured power phase angle in degrees.

Return Format <return_value><NL>

<return_value> ::= the power phase angle in degrees in NR3 format

- See Also**
- [":MEASure:SOURce"](#) on page 531
 - [":POWER:QUALity:APPLy"](#) on page 681

:MEASure:APParent

N (see [page 1384](#))

Command Syntax :MEASure:APParent [<source1>][,<source2>]

<source1>, <source2> ::= {CHANnel<n>}

<n> ::= 1 to (# analog channels) in NR1 format

The :MEASure:APParent command installs an apparent power measurement on screen.

The <source1> parameter is the channel probing voltage and the <source2> parameter is the channel probing current. These sources can also be specified by the :MEASure:SOURce command.

Apparent power is a measure of power quality. It is the portion of AC line power flow due to stored energy which returns to the source in each cycle.

$IRMS * VRMS$

Query Syntax :MEASure:APParent? [<source1>][,<source2>]

The :MEASure:APParent query returns the measured apparent power.

Return Format <return_value><NL>

<return_value> ::= the apparent power value in NR3 format

- See Also**
- [":MEASure:SOURce"](#) on page 531
 - [":POWer:QUALity:APPLy"](#) on page 681

:MEASure:CPLoss

N (see [page 1384](#))

Command Syntax :MEASure:CPLoss [<source1>] [,<source2>]

<source1> ::= {FUNCTION<m> | MATH<m>}

<source2> ::= {CHANnel<n>}

<m> ::= 1 to (# math functions) in NR1 format

<n> ::= 1 to (# analog channels) in NR1 format

The :MEASure:CPLoss command installs a power loss per cycle measurement on screen.

The <source1> parameter is typically a math multiply waveform or other waveform that represents power (voltage * current). This source can also be specified by the :MEASure:SOURce command.

Power loss per cycle is $P_n = (V_{dsn} * I_{dn}) * (\text{Time range of zoom window}) * (\text{Counter measurement of the voltage of the switching signal})$, where n is each sample.

This measurement operates when in zoom mode and the counter measurement is installed on the voltage of the switching signal.

Query Syntax :MEASure:CPLoss? [<source1>] [,<source2>]

The :MEASure:CPLoss query returns the switching loss per cycle in watts.

Return Format <return_value><NL>

<return_value> ::= the switching loss per cycle value in NR3 format

- See Also**
- [":MEASure:SOURce"](#) on page 531
 - [":POWer:SWITCh:APPLy"](#) on page 704

:MEASure:CRESt

N (see [page 1384](#))

Command Syntax :MEASure:CRESt [<source>]
 <source> ::= {CHANnel<n> | FUNction<m> | MATH<m>}
 <n> ::= 1 to (# analog channels) in NR1 format
 <m> ::= 1 to (# math functions) in NR1 format

The :MEASure:CRESt command installs a crest factor measurement on screen.

The <source> parameter is the channel probing current or voltage. This source can also be specified by the :MEASure:SOURce command.

Crest factor is a measure of power quality. It is the ratio between the instantaneous peak AC line current (or voltage) required by the load and the RMS current (or voltage). For example: I_{peak} / I_{RMS} or V_{peak} / V_{RMS} .

Query Syntax :MEASure:CRESt? [<source>]

The :MEASure:CRESt query returns the measured crest factor.

Return Format <return_value><NL>
 <return_value> ::= the crest factor value in NR3 format

- See Also**
- [":MEASure:SOURce"](#) on page 531
 - [":POWer:QUALity:APPLY"](#) on page 681

:MEASure:EFFiciency

N (see [page 1384](#))

Command Syntax :MEASure:EFFiciency

The :MEASure:EFFiciency command installs an efficiency (output power / input power) measurement on screen.

Before sending this command or query, you must specify the channels probing the input voltage, input current, output voltage, and output current (using the :POWer:SIGNals:SOURce:VOLTage<i> and :POWer:SIGNals:SOURce:CURREnt<i> commands) and you must perform the automated signals setup (using the :POWer:SIGNals:AUTOsetup EFFiciency command).

Query Syntax :MEASure:EFFiciency?

The :MEASure:EFFiciency query returns the measured efficiency as a percent value.

Return Format <return_value><NL>

<return_value> ::= percent value in NR3 format

- See Also**
- [":POWer:SIGNals:SOURce:VOLTage<i>"](#) on page 701
 - [":POWer:SIGNals:SOURce:CURREnt<i>"](#) on page 700
 - [":POWer:SIGNals:AUTOsetup"](#) on page 683
 - [":POWer:EFFiciency:APPLY"](#) on page 641

:MEASure:ELOSs

N (see [page 1384](#))

Command Syntax :MEASure:ELOSs [<source>]

<source> ::= {CHANnel<n> | FUNCTION<m> | MATH<m> | WMemory<r>}

<n> ::= 1 to (# analog channels) in NR1 format

<m> ::= 1 to (# math functions) in NR1 format

<r> ::= 1 to (# ref waveforms) in NR1 format

The :MEASure:ELOSs command installs an energy loss measurement on screen.

The <source> parameter is typically a math multiply waveform or other waveform that represents power (voltage * current). This source can also be specified by the :MEASure:SOURce command.

Energy loss = $\sum (V_{ds_n} * I_{d_n}) * \text{sample size}$, where n is each sample.

Query Syntax :MEASure:ELOSs? [<source>]

The :MEASure:ELOSs query returns the switching loss in joules.

Return Format <return_value><NL>

<return_value> ::= the energy loss value in NR3 format

- See Also**
- [":MEASure:SOURce"](#) on page 531
 - [":POWer:SWITCh:APPLY"](#) on page 704

:MEASure:FACTor

N (see [page 1384](#))

Command Syntax :MEASure:FACTor [<source1>] [,<source2>]

<source1>, <source2> ::= {CHANnel<n>}

<n> ::= 1 to (# analog channels) in NR1 format

The :MEASure:FACTor command installs a power factor measurement on screen.

The <source1> parameter is the channel probing voltage and the <source2> parameter is the channel probing current. These sources can also be specified by the :MEASure:SOURce command.

Power factor is a measure of power quality. It is the ratio of the actual AC line power to the apparent power:

Real Power / Apparent Power

Query Syntax :MEASure:FACTor? [<source1>] [,<source2>]

The :MEASure:FACTor query returns the measured power factor.

Return Format <return_value><NL>

<return_value> ::= the power factor value in NR3 format

- See Also**
- [":MEASure:SOURce"](#) on page 531
 - [":POWer:QUALity:APPLY"](#) on page 681

:MEASure:IPower

N (see [page 1384](#))

Command Syntax :MEASure:IPower

The :MEASure:IPower command installs an input power measurement on screen.

Before sending this command or query, you must specify the channels probing the input voltage, input current, output voltage, and output current (using the :POWer:SIGNals:SOURce:VOLTage<i></i> and :POWer:SIGNals:SOURce:CURREnt<i></i> commands) and you must perform the automated signals setup (using the :POWer:SIGNals:AUTOsetup EFFiciency command).

Query Syntax :MEASure:IPower?

The :MEASure:IPower query returns the measured input power.

Return Format <return_value><NL>

<return_value> ::= the input power value in NR3 format

- See Also**
- [":POWer:SIGNals:SOURce:VOLTage<i></i>"](#) on page 701
 - [":POWer:SIGNals:SOURce:CURREnt<i></i>"](#) on page 700
 - [":POWer:SIGNals:AUTOsetup"](#) on page 683
 - [":POWer:EFFiciency:APPLY"](#) on page 641

:MEASure:OFFTime

N (see [page 1384](#))

Command Syntax :MEASure:OFFTime [<source1>] [,<source2>]

<source1>, <source2> ::= {CHANnel<n>}

<n> ::= 1 to (# analog channels) in NR1 format

The :MEASure:OFFTime command installs an "off time" measurement on screen.

Turn off time measures the difference of time between when the input AC Voltage last falls to 10% of its maximum amplitude to the time when the output DC Voltage last falls to 10% of its maximum amplitude.

The <source1> parameter is the AC Voltage and the <source2> parameter is the DC Voltage. These sources can also be specified by the :MEASure:SOURce command.

Query Syntax :MEASure:OFFTime? [<source1>] [,<source2>]

The :MEASure:OFFTime query returns the measured turn off time.

Return Format <return_value><NL>

<return_value> ::= the time in seconds in NR3 format

- See Also**
- [":MEASure:SOURce"](#) on page 531
 - [":POWer:ONOff:TEST"](#) on page 666
 - [":POWer:ONOff:APPLY"](#) on page 663

:MEASure:ONTime

N (see [page 1384](#))

Command Syntax :MEASure:ONTime [<source1>] [,<source2>]

<source1>, <source2> ::= {CHANnel<n>}

<n> ::= 1 to (# analog channels) in NR1 format

The :MEASure:ONTime command installs an "on time" measurement on screen.

Turn on time measures the difference of time between when the input AC Voltage first rises to 10% of its maximum amplitude to the time when the output DC Voltage rises to 90% of its maximum amplitude.

The <source1> parameter is the AC Voltage and the <source2> parameter is the DC Voltage. These sources can also be specified by the :MEASure:SOURce command.

Query Syntax :MEASure:ONTime? [<source1>] [,<source2>]

The :MEASure:ONTime query returns the measured turn off time.

Return Format <return_value><NL>

<return_value> ::= the time in seconds in NR3 format

- See Also**
- [":MEASure:SOURce"](#) on page 531
 - [":POWer:ONOFF:TEST"](#) on page 666
 - [":POWer:ONOFF:APPLY"](#) on page 663

:MEASure:OPOWer

N (see [page 1384](#))

Command Syntax :MEASure:OPOWer

The :MEASure:OPOWer command installs an output power measurement on screen.

Before sending this command or query, you must specify the channels probing the input voltage, input current, output voltage, and output current (using the :POWer:SIGNals:SOURce:VOLTage<i> and :POWer:SIGNals:SOURce:CURREnt<i> commands) and you must perform the automated signals setup (using the :POWer:SIGNals:AUTOsetup EFFiciency command).

Query Syntax :MEASure:OPOWer?

The :MEASure:OPOWer query returns the measured output power.

Return Format <return_value><NL>

<return_value> ::= the output power value in NR3 format

- See Also**
- [":POWer:SIGNals:SOURce:VOLTage<i>"](#) on page 701
 - [":POWer:SIGNals:SOURce:CURREnt<i>"](#) on page 700
 - [":POWer:SIGNals:AUTOsetup"](#) on page 683
 - [":POWer:EFFiciency:APPLY"](#) on page 641

:MEASure:PCURrent

N (see [page 1384](#))

Command Syntax :MEASure:PCURrent [<source>]

<source> ::= {CHANnel<n> | FUNCTION<m> | MATH<m> | WMemory<r>}

<n> ::= 1 to (# analog channels) in NR1 format

<m> ::= 1 to (# math functions) in NR1 format

<r> ::= 1 to (# ref waveforms) in NR1 format

The :MEASure:PCURrent command installs a peak current measurement on screen.

The <source> parameter is the channel probing the current. This source can also be specified by the :MEASure:SOURce command.

This command measures the peak current when the power supply first turned on.

Query Syntax :MEASure:PCURrent? [<source>]

The :MEASure:PCURrent query returns the measured peak current.

Return Format <return_value><NL>

<return_value> ::= the peak current value in NR3 format

- See Also**
- [":MEASure:SOURce"](#) on page 531
 - [":POWer:INRush:APPLY"](#) on page 656

:MEASure:PLOSSs

N (see [page 1384](#))

Command Syntax :MEASure:PLOSSs [<source>]

<source> ::= {CHANnel<n> | FUNCTION<m> | MATH<m> | WMemory<r>}

<n> ::= 1 to (# analog channels) in NR1 format

<m> ::= 1 to (# math functions) in NR1 format

<r> ::= 1 to (# ref waveforms) in NR1 format

The :MEASure:PLOSSs command installs a power loss measurement on screen.

The <source> parameter is typically a math multiply waveform or other waveform that represents power (voltage * current). This source can also be specified by the :MEASure:SOURce command.

Power loss is $P_n = V_{ds_n} * I_{d_n}$, where n is each sample.

Query Syntax :MEASure:PLOSSs? [<source>]

The :MEASure:PLOSSs query returns the switching loss in watts.

Return Format <return_value><NL>

<return_value> ::= the power loss value in NR3 format

- See Also**
- [":MEASure:SOURce"](#) on page 531
 - [":POWer:SWITCh:APPLY"](#) on page 704

:MEASure:RDson

N (see [page 1384](#))

Command Syntax :MEASure:RDson [<source1>] [,<source2>]
 <source1>, <source2> ::= {CHANnel<n>| FUNCTION<m> | MATH<m>
 | WMEMory<r>}
 <n> ::= 1 to (# analog channels) in NR1 format
 <m> ::= 1 to (# math functions) in NR1 format
 <r> ::= 1 to (# ref waveforms) in NR1 format

The :MEASure:RDson command installs a power Rds(on) measurement on screen.

Rds(on) is the ON resistance between the drain and source of MOSFET. The Rds(on) characteristic is also published in the switching device data sheet.

Query Syntax :MEASure:RDson? [<source1>] [,<source2>]

The :MEASure:RDson? query returns the measured Rds(on) value.

Return Format <return_value><NL>
 <return_value> ::= the VCE(sat) value in NR3 format

See Also • [":MEASure:VCEsat"](#) on page 579

:MEASure:REACTIVE

N (see [page 1384](#))

Command Syntax :MEASure:REACTIVE [<source1>][,<source2>]

<source1>, <source2> ::= {CHANnel<n>}

<n> ::= 1 to (# analog channels) in NR1 format

The :MEASure:REACTIVE command installs a reactive power measurement on screen.

The <source1> parameter is the channel probing voltage and the <source2> parameter is the channel probing current. These sources can also be specified by the :MEASure:SOURce command.

Reactive power is a measure of power quality. It is the difference between apparent power and real power due to reactance. Using the *power triangle* (the right triangle where $\text{apparent_power}^2 = \text{real_power}^2 + \text{reactive_power}^2$):

$$\text{Reactive Power} = \sqrt{\text{Apparent Power}^2 - \text{Real Power}^2}$$

Reactive power is measured in VAR (Volts-Amps-Reactive).

Query Syntax :MEASure:REACTIVE? [<source1>][,<source2>]

The :MEASure:REACTIVE query returns the measured reactive power.

Return Format <return_value><NL>

<return_value> ::= the reactive power value in NR3 format

- See Also**
- [":MEASure:SOURce"](#) on page 531
 - [":POWer:QUALity:APPLY"](#) on page 681

:MEASure:REAL

N (see [page 1384](#))

Command Syntax :MEASure:REAL [<source>]

<source> ::= {CHANnel<n> | FUNction<m> | MATH<m>}

<n> ::= 1 to (# analog channels) in NR1 format

<m> ::= 1 to (# math functions) in NR1 format

The :MEASure:REAL command installs a real power measurement on screen.

The <source> parameter is typically a math multiply waveform or other waveform that represents power (voltage * current). This source can also be specified by the :MEASure:SOURce command.

Real power is a measure of power quality. It is the portion of power flow that, averaged over a complete cycle of the AC waveform, results in net transfer of energy in one direction.

$$\text{Real Power} = \sqrt{\frac{1}{N} \sum_{n=0}^{N-1} V_n I_n}$$

Query Syntax :MEASure:REAL? [<source>]

The :MEASure:REAL query returns the measured real power.

Return Format <return_value><NL>

<return_value> ::= the real power value in NR3 format

- See Also**
- [":MEASure:SOURce"](#) on page 531
 - [":POWER:QUALity:APPLy"](#) on page 681

:MEASure:RIPple

N (see [page 1384](#))

Command Syntax :MEASure:RIPple [<source>]

<source> ::= {CHANnel<n> | FUNCTION<m> | MATH<m> | WMemory<r>}

<n> ::= 1 to (# analog channels) in NR1 format

<m> ::= 1 to (# math functions) in NR1 format

<r> ::= 1 to (# ref waveforms) in NR1 format

The :MEASure:RIPple command installs an output ripple measurement on screen.

The <source> parameter is the channel probing the output voltage. This source can also be specified by the :MEASure:SOURce command.

Output ripple is: $V_{max} - V_{min}$.

Query Syntax :MEASure:RIPple? [<source>]

The :MEASure:RIPple query returns the measured output ripple.

Return Format <return_value><NL>

<return_value> ::= the output ripple value in NR3 format

- See Also**
- [":MEASure:SOURce"](#) on page 531
 - [":POWer:RIPple:APPLY"](#) on page 682

:MEASure:TRESponse

N (see [page 1384](#))

Command Syntax :MEASure:TRESponse [<source>]

<source> ::= {CHANnel<n> | FUNCTION<m> | MATH<m> | WMemory<r>}

<n> ::= 1 to (# analog channels) in NR1 format

<m> ::= 1 to (# math functions) in NR1 format

<r> ::= 1 to (# ref waveforms) in NR1 format

The :MEASure:TRESponse command installs a transient response time measurement on screen.

The <source> parameter is the channel probing the output voltage. This source can also be specified by the :MEASure:SOURce command.

Transient response time = $t_2 - t_1$, where:

- t_1 = The first time a voltage waveform exits the settling band.
- t_2 = The last time it enters into the settling band.
- Settling band = +/-overshoot % of the steady state output voltage.

Query Syntax :MEASure:TRESponse? [<source>]

The :MEASure:TRESponse query returns the measured transient response time.

Return Format <return_value><NL>

<return_value> ::= time in seconds for the overshoot to settle back into the band in NR3 format

- See Also**
- [":MEASure:SOURce"](#) on page 531
 - [":POWER:TRANSient:APPLY"](#) on page 710

:MEASure:VCESat

N (see [page 1384](#))

Command Syntax :MEASure:VCESat [<source>]

<source> ::= {CHANnel<n> | FUNCTION<m> | MATH<m> | WMemory<r>}

<n> ::= 1 to (# analog channels) in NR1 format

<m> ::= 1 to (# math functions) in NR1 format

<r> ::= 1 to (# ref waveforms) in NR1 format

The :MEASure:VCESat command installs a power Vce(sat) measurement on screen.

Vce(sat) is the saturation voltage between the collector and emitter of a BJT. The Vce(sat) characteristic is also published in the switching device data sheet.

Query Syntax :MEASure:VCESat? [<source>]

The :MEASure:VCESat? query returns the measured Vce(sat) value.

Return Format <return_value><NL>

<return_value> ::= the VCE(sat) value in NR3 format

See Also • [":MEASure:RDSON"](#) on page 574

24 :MTESt Commands

The MTESt subsystem commands and queries control the mask test features. See "[Introduction to :MTESt Commands](#)" on page 583.

Table 106: MTESt Commands Summary

Command	Query	Options and Query Returns
:MTESt:ALL {{0 OFF} {1 ON}} (see page 586)	:MTESt:ALL? (see page 586)	{0 1}
:MTESt:AMASK:CREate (see page 587)	n/a	n/a
:MTESt:AMASK:SOURce <source> (see page 588)	:MTESt:AMASK:SOURce? (see page 588)	<source> ::= CHANNEL<n> <n> ::= {1 2 3 4} for 4ch models <n> ::= {1 2} for 2ch models
:MTESt:AMASK:UNITs <units> (see page 589)	:MTESt:AMASK:UNITs? (see page 589)	<units> ::= {CURRENT DIVISIONS}
:MTESt:AMASK:XDELta <value> (see page 590)	:MTESt:AMASK:XDELta? (see page 590)	<value> ::= X delta value in NR3 format
:MTESt:AMASK:YDELta <value> (see page 591)	:MTESt:AMASK:YDELta? (see page 591)	<value> ::= Y delta value in NR3 format
n/a	:MTESt:COUNT:FWAVEforms? [CHANNEL<n>] (see page 592)	<failed> ::= number of failed waveforms in NR1 format
:MTESt:COUNT:RESet (see page 593)	n/a	n/a
n/a	:MTESt:COUNT:TIME? (see page 594)	<time> ::= elapsed seconds in NR3 format
n/a	:MTESt:COUNT:WAVEform s? (see page 595)	<count> ::= number of waveforms in NR1 format
:MTESt:DATA <mask> (see page 596)	:MTESt:DATA? (see page 596)	<mask> ::= data in IEEE 488.2 # format.

Table 106: MTESt Commands Summary (continued)

Command	Query	Options and Query Returns
:MTESt:DELeTe (see page 597)	n/a	n/a
:MTESt:ENABLe {{0 OFF} {1 ON}} (see page 598)	:MTESt:ENABLe? (see page 598)	{0 1}
:MTESt:LOCK {{0 OFF} {1 ON}} (see page 599)	:MTESt:LOCK? (see page 599)	{0 1}
:MTESt:RMODe <rmode> (see page 600)	:MTESt:RMODe? (see page 600)	<rmode> ::= {FORever TIME SIGMa WAVeforms}
:MTESt:RMODe:FACTion:MEASure {{0 OFF} {1 ON}} (see page 601)	:MTESt:RMODe:FACTion:MEASure? (see page 601)	{0 1}
:MTESt:RMODe:FACTion:PRINt {{0 OFF} {1 ON}} (see page 602)	:MTESt:RMODe:FACTion:PRINt? (see page 602)	{0 1}
:MTESt:RMODe:FACTion:SAVE {{0 OFF} {1 ON}} (see page 603)	:MTESt:RMODe:FACTion:SAVE? (see page 603)	{0 1}
:MTESt:RMODe:FACTion:STOP {{0 OFF} {1 ON}} (see page 604)	:MTESt:RMODe:FACTion:STOP? (see page 604)	{0 1}
:MTESt:RMODe:SIGMa <level> (see page 605)	:MTESt:RMODe:SIGMa? (see page 605)	<level> ::= from 0.1 to 9.3 in NR3 format
:MTESt:RMODe:TIME <seconds> (see page 606)	:MTESt:RMODe:TIME? (see page 606)	<seconds> ::= from 1 to 86400 in NR3 format
:MTESt:RMODe:WAVeform s <count> (see page 607)	:MTESt:RMODe:WAVeform s? (see page 607)	<count> ::= number of waveforms in NR1 format
:MTESt:SCALE:BINd {{0 OFF} {1 ON}} (see page 608)	:MTESt:SCALE:BINd? (see page 608)	{0 1}
:MTESt:SCALE:X1 <x1_value> (see page 609)	:MTESt:SCALE:X1? (see page 609)	<x1_value> ::= X1 value in NR3 format
:MTESt:SCALE:XDELta <xdelta_value> (see page 610)	:MTESt:SCALE:XDELta? (see page 610)	<xdelta_value> ::= X delta value in NR3 format

Table 106: MTESt Commands Summary (continued)

Command	Query	Options and Query Returns
:MTESt:SCALe:Y1 <y1_value> (see page 611)	:MTESt:SCALe:Y1? (see page 611)	<y1_value> ::= Y1 value in NR3 format
:MTESt:SCALe:Y2 <y2_value> (see page 612)	:MTESt:SCALe:Y2? (see page 612)	<y2_value> ::= Y2 value in NR3 format
:MTESt:SOURce <source> (see page 613)	:MTESt:SOURce? (see page 613)	<source> ::= {CHANnel<n> NONE} <n> ::= {1 2 3 4} for 4ch models <n> ::= {1 2} for 2ch models
n/a	:MTESt:TITLe? (see page 614)	<title> ::= a string of up to 128 ASCII characters

Introduction to :MTESt Commands

Mask testing automatically compares the current displayed waveform with the boundaries of a set of polygons that you define. Any waveform or sample that falls within the boundaries of one or more polygons is recorded as a failure.

Reporting the Setup

Use :MTESt? to query setup information for the MTESt subsystem.

Return Format

The following is a sample response from the :MTESt? query. In this case, the query was issued following a *RST command.

```
:MTES:SOUR CHAN1;ENAB 0;LOCK 1;:MTES:AMAS:SOUR CHAN1;UNIT DIV;XDEL
+2.50000000E-001;YDEL +2.50000000E-001;:MTES:SCAL:X1 +200.000E-06;XDEL
+400.000E-06;Y1 -3.00000E+00;Y2 +3.00000E+00;BIND 0;:MTES:RMOD
FOR;RMOD:TIME +1E+00;WAV 1000;SIGM +6.0E+00;:MTES:RMOD:FACT:STOP
0;PRIN 0;SAVE 0
```

Example Code

```
' Mask testing commands example.
' -----

Option Explicit

Public myMgr As VisaComLib.ResourceManager
Public myScope As VisaComLib.FormattedIO488
Public varQueryResult As Variant
Public strQueryResult As String

Private Declare Sub Sleep Lib "kernel32" (ByVal dwMilliseconds As Long)

Sub Main()
```

```

On Error GoTo VisaComError

' Create the VISA COM I/O resource.
Set myMgr = New VisaComLib.ResourceManager
Set myScope = New VisaComLib.FormattedIO488
Set myScope.IO = _
    myMgr.Open("USB0::0x0957::0x17A6::US50210029::0::INSTR")
myScope.IO.Clear ' Clear the interface.

' Make sure oscilloscope is running.
myScope.WriteString ":RUN"

' Set mask test termination conditions.
myScope.WriteString ":MTEST:RMODE SIGMa"
myScope.WriteString ":MTEST:RMODE?"
strQueryResult = myScope.ReadString
Debug.Print "Mask test termination mode: " + strQueryResult

myScope.WriteString ":MTEST:RMODE:SIGMa 4.2"
myScope.WriteString ":MTEST:RMODE:SIGMa?"
varQueryResult = myScope.ReadNumber
Debug.Print "Mask test termination 'test sigma': " + _
    FormatNumber(varQueryResult)

' Use auto-mask to create mask.
myScope.WriteString ":MTEST:AMASK:SOURce CHANnel1"
myScope.WriteString ":MTEST:AMASK:SOURce?"
strQueryResult = myScope.ReadString
Debug.Print "Mask test auto-mask source: " + strQueryResult

myScope.WriteString ":MTEST:AMASK:UNITs DIVisions"
myScope.WriteString ":MTEST:AMASK:UNITs?"
strQueryResult = myScope.ReadString
Debug.Print "Mask test auto-mask units: " + strQueryResult

myScope.WriteString ":MTEST:AMASK:XDELta 0.1"
myScope.WriteString ":MTEST:AMASK:XDELta?"
varQueryResult = myScope.ReadNumber
Debug.Print "Mask test auto-mask X delta: " + _
    FormatNumber(varQueryResult)

myScope.WriteString ":MTEST:AMASK:YDELta 0.1"
myScope.WriteString ":MTEST:AMASK:YDELta?"
varQueryResult = myScope.ReadNumber
Debug.Print "Mask test auto-mask Y delta: " + _
    FormatNumber(varQueryResult)

' Enable "Auto Mask Created" event (bit 10, &H400)
myScope.WriteString "*CLS"
myScope.WriteString ":MTEenable " + CStr(CInt("&H400"))

' Create mask.
myScope.WriteString ":MTEST:AMASK:CREate"
Debug.Print "Auto-mask created, mask test automatically enabled."

' Set up timeout variables.
Dim lngTimeout As Long ' Max millisecs to wait.

```



```

Dim lngElapsed As Long
lngTimeout = 60000 ' 60 seconds.

' Wait until mask is created.
lngElapsed = 0
Do While lngElapsed <= lngTimeout
    myScope.WriteString ":OPERRegister:CONDition?"
    varQueryResult = myScope.ReadNumber
    ' Operation Status Condition Register MTE bit (bit 9, &H200).
    If (varQueryResult And &H200) <> 0 Then
        Exit Do
    Else
        Sleep 100 ' Small wait to prevent excessive queries.
        lngElapsed = lngElapsed + 100
    End If
Loop

' Look for RUN bit = stopped (mask test termination).
lngElapsed = 0
Do While lngElapsed <= lngTimeout
    myScope.WriteString ":OPERRegister:CONDition?"
    varQueryResult = myScope.ReadNumber
    ' Operation Status Condition Register RUN bit (bit 3, &H8).
    If (varQueryResult And &H8) = 0 Then
        Exit Do
    Else
        Sleep 100 ' Small wait to prevent excessive queries.
        lngElapsed = lngElapsed + 100
    End If
Loop

' Get total waveforms, failed waveforms, and test time.
myScope.WriteString ":MTEST:COUNT:WAVEforms?"
strQueryResult = myScope.ReadString
Debug.Print "Mask test total waveforms: " + strQueryResult

myScope.WriteString ":MTEST:COUNT:FWAVEforms?"
strQueryResult = myScope.ReadString
Debug.Print "Mask test failed waveforms: " + strQueryResult

myScope.WriteString ":MTEST:COUNT:TIME?"
strQueryResult = myScope.ReadString
Debug.Print "Mask test elapsed seconds: " + strQueryResult

Exit Sub

VisaComError:
MsgBox "VISA COM Error:" + vbCrLf + Err.Description

End Sub

```

:MTESt:ALL

N (see [page 1384](#))

Command Syntax :MTESt:ALL <on_off>

<on_off> ::= {{1 | ON} | {0 | OFF}}

The :MTESt:ALL command specifies the channel(s) that are included in the mask test:

- ON – All displayed analog channels are included in the mask test.
- OFF – Just the selected source channel is included in the test.

Query Syntax :MTESt:ENABle?

The :MTESt:ENABle? query returns the current setting.

Return Format <on_off><NL>

<on_off> ::= {1 | 0}

See Also • ["Introduction to :MTESt Commands"](#) on page 583

:MTESt:AMASk:CREate

N (see [page 1384](#))

Command Syntax

`:MTESt:AMASk:CREate`

The `:MTESt:AMASk:CREate` command automatically constructs a mask around the current selected channel, using the tolerance parameters defined by the `:MTESt:AMASk:XDELta`, `:MTESt:AMASk:YDELta`, and `:MTESt:AMASk:UNITs` commands. The mask only encompasses the portion of the waveform visible on the display, so you must ensure that the waveform is acquired and displayed consistently to obtain repeatable results.

The `:MTESt:SOURce` command selects the channel and should be set before using this command.

- See Also
- ["Introduction to :MTESt Commands"](#) on page 583
 - [":MTESt:AMASk:XDELta"](#) on page 590
 - [":MTESt:AMASk:YDELta"](#) on page 591
 - [":MTESt:AMASk:UNITs"](#) on page 589
 - [":MTESt:AMASk:SOURce"](#) on page 588
 - [":MTESt:SOURce"](#) on page 613

- Example Code
- ["Example Code"](#) on page 583

:MTESt:AMASk:SOURce

N (see [page 1384](#))

Command Syntax :MTESt:AMASk:SOURce <source>

<source> ::= CHANnel<n>

<n> ::= 1 to (# analog channels) in NR1 format

The :MTESt:AMASk:SOURce command selects the source for the interpretation of the :MTESt:AMASk:XDELta and :MTESt:AMASk:YDELta parameters when :MTESt:AMASk:UNITs is set to CURRent.

When UNITs are CURRent, the XDELta and YDELta parameters are defined in terms of the channel units, as set by the :CHANnel<n>:UNITs command, of the selected source.

Suppose that UNITs are CURRent and that you set SOURce to CHANNEL1, which is using units of volts. Then you can define AMASk:XDELta in terms of volts and AMASk:YDELta in terms of seconds.

This command is the same as the :MTESt:SOURce command.

Query Syntax :MTESt:AMASk:SOURce?

The :MTESt:AMASk:SOURce? query returns the currently set source.

Return Format <source> ::= CHAN<n>

<n> ::= 1 to (# analog channels) in NR1 format

- See Also**
- ["Introduction to :MTESt Commands"](#) on page 583
 - [":MTESt:AMASk:XDELta"](#) on page 590
 - [":MTESt:AMASk:YDELta"](#) on page 591
 - [":MTESt:AMASk:UNITs"](#) on page 589
 - [":MTESt:SOURce"](#) on page 613

Example Code • ["Example Code"](#) on page 583

:MTESt:AMASk:UNITs

N (see [page 1384](#))

Command Syntax :MTESt:AMASk:UNITs <units>

<units> ::= {CURRENT | DIVisions}

The :MTESt:AMASk:UNITs command alters the way the mask test subsystem interprets the tolerance parameters for automasking as defined by :MTESt:AMASk:XDELta and :MTESt:AMASk:YDELta commands.

- CURRENT – the mask test subsystem uses the units as set by the :CHANnel<n>:UNITs command, usually time for ΔX and voltage for ΔY .
- DIVisions – the mask test subsystem uses the graticule as the measurement system, so tolerance settings are specified as parts of a screen division. The mask test subsystem maintains separate XDELta and YDELta settings for CURRENT and DIVisions. Thus, XDELta and YDELta are not converted to new values when the UNITs setting is changed.

Query Syntax :MTESt:AMASk:UNITs?

The :MTESt:AMASk:UNITs query returns the current measurement units setting for the mask test automask feature.

Return Format <units><NL>

<units> ::= {CURR | DIV}

- See Also**
- ["Introduction to :MTESt Commands"](#) on page 583
 - [":MTESt:AMASk:XDELta"](#) on page 590
 - [":MTESt:AMASk:YDELta"](#) on page 591
 - [":CHANnel<n>:UNITs"](#) on page 310
 - [":MTESt:AMASk:SOURce"](#) on page 588
 - [":MTESt:SOURce"](#) on page 613

Example Code • ["Example Code"](#) on page 583

:MTESt:AMASk:XDELta

N (see [page 1384](#))

Command Syntax `:MTESt:AMASk:XDELta <value>`
 `<value> ::= X delta value in NR3 format`

The `:MTESt:AMASk:XDELta` command sets the tolerance in the X direction around the waveform for the automasking feature. The absolute value of the tolerance will be added and subtracted to horizontal values of the waveform to determine the boundaries of the mask.

The horizontal tolerance value is interpreted based on the setting specified by the `:MTESt:AMASk:UNITs` command; thus, if you specify 250-E3, the setting for `:MTESt:AMASk:UNITs` is `CURRent`, and the current setting specifies time in the horizontal direction, the tolerance will be ± 250 ms. If the setting for `:MTESt:AMASk:UNITs` is `DIVisions`, the same X delta value will set the tolerance to ± 250 millidivisions, or 1/4 of a division.

Query Syntax `:MTESt:AMASk:XDELta?`

The `:MTESt:AMASk:XDELta?` query returns the current setting of the ΔX tolerance for automasking. If your computer program will interpret this value, it should also request the current measurement system using the `:MTESt:AMASk:UNITs` query.

Return Format `<value><NL>`
 `<value> ::= X delta value in NR3 format`

- See Also**
- ["Introduction to :MTESt Commands"](#) on page 583
 - [":MTESt:AMASk:UNITs"](#) on page 589
 - [":MTESt:AMASk:YDELta"](#) on page 591
 - [":MTESt:AMASk:SOURce"](#) on page 588
 - [":MTESt:SOURce"](#) on page 613

Example Code • ["Example Code"](#) on page 583

:MTESt:AMASk:YDELta

N (see [page 1384](#))

Command Syntax :MTESt:AMASk:YDELta <value>
 <value> ::= Y delta value in NR3 format

The :MTESt:AMASk:YDELta command sets the vertical tolerance around the waveform for the automasking feature. The absolute value of the tolerance will be added and subtracted to vertical values of the waveform to determine the boundaries of the mask.

The vertical tolerance value is interpreted based on the setting specified by the :MTESt:AMASk:UNITs command; thus, if you specify 250-E3, the setting for :MTESt:AMASk:UNITs is CURRent, and the current setting specifies voltage in the vertical direction, the tolerance will be ± 250 mV. If the setting for :MTESt:AMASk:UNITs is DIVisions, the same Y delta value will set the tolerance to ± 250 millidivisions, or 1/4 of a division.

Query Syntax :MTESt:AMASk:YDELta?

The :MTESt:AMASk:YDELta? query returns the current setting of the ΔY tolerance for automasking. If your computer program will interpret this value, it should also request the current measurement system using the :MTESt:AMASk:UNITs query.

Return Format <value><NL>
 <value> ::= Y delta value in NR3 format

- See Also**
- ["Introduction to :MTESt Commands"](#) on page 583
 - [":MTESt:AMASk:UNITs"](#) on page 589
 - [":MTESt:AMASk:XDELta"](#) on page 590
 - [":MTESt:AMASk:SOURce"](#) on page 588
 - [":MTESt:SOURce"](#) on page 613

Example Code • ["Example Code"](#) on page 583

:MTESt:COUNT:FWAVEforms

N (see [page 1384](#))

Query Syntax :MTESt:COUNT:FWAVEforms? [CHANnel<n>]

<n> ::= 1 to (# analog channels) in NR1 format

The :MTESt:COUNT:FWAVEforms? query returns the total number of failed waveforms in the current mask test run. This count is for all regions and all waveforms collected on the channel specified by the optional parameter or collected on the currently specified source channel (:MTESt:SOURce) if there is no parameter.

Return Format <failed><NL>

<failed> ::= number of failed waveforms in NR1 format.

- See Also**
- ["Introduction to :MTESt Commands"](#) on page 583
 - [":MTESt:COUNT:WAVEforms"](#) on page 595
 - [":MTESt:COUNT:TIME"](#) on page 594
 - [":MTESt:COUNT:RESet"](#) on page 593
 - [":MTESt:SOURce"](#) on page 613

Example Code • ["Example Code"](#) on page 583

:MTESt:COUNT:RESet

N (see [page 1384](#))

Command Syntax :MTESt:COUNT:RESet

The :MTESt:COUNT:RESet command resets the mask statistics.

- See Also**
- ["Introduction to :MTESt Commands"](#) on page 583
 - [":MTESt:COUNT:WAVEforms"](#) on page 595
 - [":MTESt:COUNT:FWAVEforms"](#) on page 592
 - [":MTESt:COUNT:TIME"](#) on page 594

:MTESt:COUNT:TIME

N (see [page 1384](#))

Query Syntax :MTESt:COUNT:TIME?

The :MTESt:COUNT:TIME? query returns the elapsed time in the current mask test run.

Return Format <time><NL>

<time> ::= elapsed seconds in NR3 format.

- See Also**
- ["Introduction to :MTESt Commands"](#) on page 583
 - [":MTESt:COUNT:WAVEforms"](#) on page 595
 - [":MTESt:COUNT:FWAVEforms"](#) on page 592
 - [":MTESt:COUNT:RESet"](#) on page 593

Example Code • ["Example Code"](#) on page 583

:MTESt:COUNT:WAVEforms

N (see [page 1384](#))

Query Syntax :MTESt:COUNT:WAVEforms?

The :MTESt:COUNT:WAVEforms? query returns the total number of waveforms acquired in the current mask test run.

Return Format <count><NL>

<count> ::= number of waveforms in NR1 format.

- See Also**
- ["Introduction to :MTESt Commands"](#) on page 583
 - [":MTESt:COUNT:FWAVEforms"](#) on page 592
 - [":MTESt:COUNT:TIME"](#) on page 594
 - [":MTESt:COUNT:RESet"](#) on page 593

Example Code • ["Example Code"](#) on page 583

:MTESt:DATA

N (see [page 1384](#))

Command Syntax :MTESt:DATA <mask>

<mask> ::= binary block data in IEEE 488.2 # format.

The :MTESt:DATA command loads a mask from binary block data.

Query Syntax :MTESt:DATA?

The :MTESt:DATA? query returns a mask in binary block data format. The format for the data transmission is the # format defined in the IEEE 488.2 specification.

Return Format <mask><NL>

<mask> ::= binary block data in IEEE 488.2 # format

- See Also**
- [":SAVE:MASK\[:START\]"](#) on page 737
 - [":RECall:MASK\[:START\]"](#) on page 721

:MTESt:DELeTe

N (see [page 1384](#))

Command Syntax :MTESt:DELeTe

The :MTESt:DELeTe command clears the currently loaded mask.

- See Also**
- ["Introduction to :MTESt Commands"](#) on page 583
 - [":MTESt:AMASk:CREate"](#) on page 587

:MTESt:ENABle

N (see [page 1384](#))

Command Syntax :MTESt:ENABle <on_off>
 <on_off> ::= {{1 | ON} | {0 | OFF}}

The :MTESt:ENABle command enables or disables the mask test features.

- ON – Enables the mask test features.
- OFF – Disables the mask test features.

Query Syntax :MTESt:ENABle?

The :MTESt:ENABle? query returns the current state of mask test features.

Return Format <on_off><NL>
 <on_off> ::= {1 | 0}

See Also • ["Introduction to :MTESt Commands"](#) on page 583

:MTESt:LOCK

N (see [page 1384](#))

Command Syntax :MTESt:LOCK <on_off>
 <on_off> ::= {{1 | ON} | {0 | OFF}}

The :MTESt:LOCK command enables or disables the mask lock feature:

- ON – Locks a mask to the SOURce. As the vertical or horizontal scaling or position of the SOURce changes, the mask is redrawn accordingly.
- OFF – The mask is static and does not move.

Query Syntax :MTESt:LOCK?

The :MTESt:LOCK? query returns the current mask lock setting.

Return Format <on_off><NL>
 <on_off> ::= {1 | 0}

- See Also**
- ["Introduction to :MTESt Commands"](#) on page 583
 - [":MTESt:SOURce"](#) on page 613

:MTESt:RMODe

N (see [page 1384](#))

Command Syntax :MTESt:RMODe <rmode>
<rmode> ::= {FORever | SIGMa | TIME | WAVeforms}

The :MTESt:RMODe command specifies the termination conditions for the mask test:

- FORever – the mask test runs until it is turned off.
- SIGMa – the mask test runs until the Sigma level is reached. This level is set by the **":MTESt:RMODe:SIGMa"** on page 605 command.
- TIME – the mask test runs for a fixed amount of time. The amount of time is set by the **":MTESt:RMODe:TIME"** on page 606 command.
- WAVeforms – the mask test runs until a fixed number of waveforms are acquired. The number of waveforms is set by the **":MTESt:RMODe:WAVeforms"** on page 607 command.

Query Syntax :MTESt:RMODe?

The :MTESt:RMODe? query returns the currently set termination condition.

Return Format <rmode><NL>
<rmode> ::= {FOR | SIGM | TIME | WAV}

- See Also**
- **"Introduction to :MTESt Commands"** on page 583
 - **":MTESt:RMODe:SIGMa"** on page 605
 - **":MTESt:RMODe:TIME"** on page 606
 - **":MTESt:RMODe:WAVeforms"** on page 607

Example Code • **"Example Code"** on page 583

:MTESt:RMODe:FACTion:MEASure

N (see [page 1384](#))

Command Syntax :MTESt:RMODe:FACTion:MEASure <on_off>

<on_off> ::= {{1 | ON} | {0 | OFF}}

The :MTESt:RMODe:FACTion:MEASure command sets measuring only mask failures on or off.

When ON, measurements and measurement statistics run only on waveforms that contain a mask violation; passing waveforms do not affect measurements and measurement statistics.

This mode is not available when the acquisition mode is set to Averaging.

Query Syntax :MTESt:RMODe:FACTion:MEASure?

The :MTESt:RMODe:FACTion:MEASure? query returns the current mask failure measure setting.

Return Format <on_off><NL>

<on_off> ::= {1 | 0}

- See Also**
- ["Introduction to :MTESt Commands"](#) on page 583
 - [":MTESt:RMODe:FACTion:PRINt"](#) on page 602
 - [":MTESt:RMODe:FACTion:SAVE"](#) on page 603
 - [":MTESt:RMODe:FACTion:STOP"](#) on page 604

:MTESt:RMODe:FACTion:PRINt

N (see [page 1384](#))

Command Syntax :MTESt:RMODe:FACTion:PRINt <on_off>

<on_off> ::= {{1 | ON} | {0 | OFF}}

The :MTESt:RMODe:FACTion:PRINt command sets printing on mask failures on or off.

NOTE

Setting :MTESt:RMODe:FACTion:PRINt ON automatically sets :MTESt:RMODe:FACTion:SAVE OFF.

See [Chapter 19](#), “:HARDcopy Commands,” starting on page 431 for more information on setting the hardcopy device and formatting options.

Query Syntax :MTESt:RMODe:FACTion:PRINt?

The :MTESt:RMODe:FACTion:PRINt? query returns the current mask failure print setting.

Return Format <on_off><NL>

<on_off> ::= {1 | 0}

- See Also**
- ["Introduction to :MTESt Commands"](#) on page 583
 - [":MTESt:RMODe:FACTion:MEASure"](#) on page 601
 - [":MTESt:RMODe:FACTion:SAVE"](#) on page 603
 - [":MTESt:RMODe:FACTion:STOP"](#) on page 604

:MTESt:RMODe:FACTion:SAVE

N (see [page 1384](#))

Command Syntax :MTESt:RMODe:FACTion:SAVE <on_off>
 <on_off> ::= {{1 | ON} | {0 | OFF}}

The :MTESt:RMODe:FACTion:SAVE command sets saving on mask failures on or off.

NOTE

Setting :MTESt:RMODe:FACTion:SAVE ON automatically sets :MTESt:RMODe:FACTion:PRINT OFF.

See [Chapter 28](#), “:SAVE Commands,” starting on page 725 for more information on save options.

Query Syntax :MTESt:RMODe:FACTion:SAVE?

The :MTESt:RMODe:FACTion:SAVE? query returns the current mask failure save setting.

Return Format <on_off><NL>

<on_off> ::= {1 | 0}

- See Also**
- ["Introduction to :MTESt Commands"](#) on page 583
 - [":MTESt:RMODe:FACTion:MEASure"](#) on page 601
 - [":MTESt:RMODe:FACTion:PRINT"](#) on page 602
 - [":MTESt:RMODe:FACTion:STOP"](#) on page 604

:MTESt:RMODe:FACTion:STOP

N (see [page 1384](#))

Command Syntax :MTESt:RMODe:FACTion:STOP <on_off>

<on_off> ::= {{1 | ON} | {0 | OFF}}

The :MTESt:RMODe:FACTion:STOP command sets stopping on a mask failure on or off. When this setting is ON and a mask violation is detected, the mask test is stopped and the acquisition system is stopped.

Query Syntax :MTESt:RMODe:FACTion:STOP?

The :MTESt:RMODe:FACTion:STOP? query returns the current mask failure stop setting.

Return Format <on_off><NL>

<on_off> ::= {1 | 0}

- See Also**
- ["Introduction to :MTESt Commands"](#) on page 583
 - [":MTESt:RMODe:FACTion:MEASure"](#) on page 601
 - [":MTESt:RMODe:FACTion:PRINT"](#) on page 602
 - [":MTESt:RMODe:FACTion:SAVE"](#) on page 603

:MTEST:RMODE:SIGMa

N (see [page 1384](#))

Command Syntax :MTEST:RMODE:SIGMa <level>

<level> ::= from 0.1 to 9.3 in NR3 format

When the :MTEST:RMODE command is set to SIGMa, the :MTEST:RMODE:SIGMa command sets the *test sigma* level to which a mask test runs. *Test sigma* is the best achievable process sigma, assuming no failures. (*Process sigma* is calculated using the number of failures per test.) The *test sigma* level indirectly specifies the number of waveforms that must be tested (in order to reach the sigma level).

Query Syntax :MTEST:RMODE:SIGMa?

The :MTEST:RMODE:SIGMa? query returns the current Sigma level setting.

Return Format <level><NL>

<level> ::= from 0.1 to 9.3 in NR3 format

- See Also**
- ["Introduction to :MTEST Commands"](#) on page 583
 - [":MTEST:RMODE"](#) on page 600

- Example Code**
- ["Example Code"](#) on page 583

:MTESt:RMODE:TIME

N (see [page 1384](#))

Command Syntax :MTESt:RMODE:TIME <seconds>

<seconds> ::= from 1 to 86400 in NR3 format

When the :MTESt:RMODE command is set to TIME, the :MTESt:RMODE:TIME command sets the number of seconds for a mask test to run.

Query Syntax :MTESt:RMODE:TIME?

The :MTESt:RMODE:TIME? query returns the number of seconds currently set.

Return Format <seconds><NL>

<seconds> ::= from 1 to 86400 in NR3 format

- See Also**
- ["Introduction to :MTESt Commands"](#) on page 583
 - [":MTESt:RMODE"](#) on page 600

:MTESt:RMODE:WAVeforms

N (see [page 1384](#))

Command Syntax :MTESt:RMODE:WAVeforms <count>

<count> ::= number of waveforms in NR1 format
from 1 to 2,000,000,000

When the :MTESt:RMODE command is set to WAVeforms, the :MTESt:RMODE:WAVeforms command sets the number of waveform acquisitions that are mask tested.

Query Syntax :MTESt:RMODE:WAVeforms?

The :MTESt:RMODE:WAVeforms? query returns the number of waveforms currently set.

Return Format <count><NL>

<count> ::= number of waveforms in NR1 format
from 1 to 2,000,000,000

- See Also**
- ["Introduction to :MTESt Commands"](#) on page 583
 - [":MTESt:RMODE"](#) on page 600

:MTESt:SCALe:BIND

N (see [page 1384](#))

Command Syntax :MTESt:SCALe:BIND <on_off>

<on_off> ::= {{1 | ON} | {0 | OFF}}

The :MTESt:SCALe:BIND command enables or disables Bind 1 & 0 Levels (Bind -1 & 0 Levels for inverted masks) control:

- ON –

If the Bind 1 & 0 Levels control is enabled, the 1 Level and the 0 Level controls track each other. Adjusting either the 1 Level or the 0 Level control shifts the position of the mask up or down without changing its size.

If the Bind -1 & 0 Levels control is enabled, the -1 Level and the 0 Level controls track each other. Adjusting either the -1 Level or the 0 Level control shifts the position of the mask up or down without changing its size.

- OFF –

If the Bind 1 & 0 Levels control is disabled, adjusting either the 1 Level or the 0 Level control changes the vertical height of the mask.

If the Bind -1 & 0 Levels control is disabled, adjusting either the -1 Level or the 0 Level control changes the vertical height of the mask.

Query Syntax :MTESt:SCALe:BIND?

The :MTESt:SCALe:BIND? query returns the value of the Bind 1&0 control (Bind -1&0 for inverted masks).

Return Format <on_off><NL>

<on_off> ::= {1 | 0}

- See Also**
- ["Introduction to :MTESt Commands"](#) on page 583
 - [":MTESt:SCALe:X1"](#) on page 609
 - [":MTESt:SCALe:XDELta"](#) on page 610
 - [":MTESt:SCALe:Y1"](#) on page 611
 - [":MTESt:SCALe:Y2"](#) on page 612

:MTESt:SCALe:X1

N (see [page 1384](#))

Command Syntax :MTESt:SCALe:X1 <x1_value>
 <x1_value> ::= X1 value in NR3 format

The :MTESt:SCALe:X1 command defines where X=0 in the base coordinate system used for mask testing. The other X-coordinate is defined by the :MTESt:SCALe:XDELta command. Once the X1 and XDELta coordinates are set, all X values of vertices in the mask regions are defined with respect to this value, according to the equation:

$$x = (X * \Delta X) + X1$$

Thus, if you set X1 to 100 ms, and XDELta to 100 ms, an X value of 0.100 is a vertex at 110 ms.

The oscilloscope uses this equation to normalize vertices. This simplifies reprogramming to handle different data rates. For example, if you halve the period of the waveform of interest, you need only to adjust the XDELta value to set up the mask for the new waveform.

The X1 value is a time value specifying the location of the X1 coordinate, which will then be treated as X=0 for mask regions coordinates.

Query Syntax :MTESt:SCALe:X1?

The :MTESt:SCALe:X1? query returns the current X1 coordinate setting.

Return Format <x1_value><NL>
 <x1_value> ::= X1 value in NR3 format

- See Also**
- ["Introduction to :MTESt Commands"](#) on page 583
 - [":MTESt:SCALe:BIND"](#) on page 608
 - [":MTESt:SCALe:XDELta"](#) on page 610
 - [":MTESt:SCALe:Y1"](#) on page 611
 - [":MTESt:SCALe:Y2"](#) on page 612

:MTESt:SCALe:XDELta

N (see [page 1384](#))

Command Syntax `:MTESt:SCALe:XDELta <xdelta_value>`

`<xdelta_value> ::= X delta value in NR3 format`

The :MTESt:SCALe:XDELta command defines the position of the X2 marker with respect to the X1 marker. In the mask test coordinate system, the X1 marker defines where X=0; thus, the X2 marker defines where X=1.

Because all X vertices of the regions defined for mask testing are normalized with respect to X1 and ΔX , redefining ΔX also moves those vertices to stay in the same locations with respect to X1 and ΔX . Thus, in many applications, it is best if you define XDELta as a pulse width or bit period. Then, a change in data rate without corresponding changes in the waveform can easily be handled by changing ΔX .

The X-coordinate of polygon vertices is normalized using this equation:

$$x = (X * \Delta X) + X1$$

The X delta value is a time value specifying the distance of the X2 marker with respect to the X1 marker.

For example, if the period of the waveform you wish to test is 1 ms, setting ΔX to 1 ms ensures that the waveform's period is between the X1 and X2 markers.

Query Syntax `:MTESt:SCALe:XDELta?`

The :MTESt:SCALe:XDELta? query returns the current value of ΔX .

Return Format `<xdelta_value><NL>`

`<xdelta_value> ::= X delta value in NR3 format`

- See Also**
- ["Introduction to :MTESt Commands"](#) on page 583
 - [":MTESt:SCALe:BIND"](#) on page 608
 - [":MTESt:SCALe:X1"](#) on page 609
 - [":MTESt:SCALe:Y1"](#) on page 611
 - [":MTESt:SCALe:Y2"](#) on page 612

:MTESt:SCALe:Y1

N (see [page 1384](#))

Command Syntax :MTESt:SCALe:Y1 <y1_value>

<y1_value> ::= Y1 value in NR3 format

The :MTESt:SCALe:Y1 command defines where Y=0 in the coordinate system for mask testing. All Y values of vertices in the coordinate system are defined with respect to the boundaries set by SCALe:Y1 and SCALe:Y2 according to the equation:

$$Y = (Y * (Y2 - Y1)) + Y1$$

Thus, if you set Y1 to 100 mV, and Y2 to 1 V, a Y value of 0.100 in a vertex is at 190 mV.

The Y1 value is a voltage value specifying the point at which Y=0.

Query Syntax :MTESt:SCALe:Y1?

The :MTESt:SCALe:Y1? query returns the current setting of the Y1 marker.

Return Format <y1_value><NL>

<y1_value> ::= Y1 value in NR3 format

- See Also**
- ["Introduction to :MTESt Commands"](#) on page 583
 - [":MTESt:SCALe:BIND"](#) on page 608
 - [":MTESt:SCALe:X1"](#) on page 609
 - [":MTESt:SCALe:XDELta"](#) on page 610
 - [":MTESt:SCALe:Y2"](#) on page 612

:MTESt:SCALe:Y2

N (see [page 1384](#))

Command Syntax :MTESt:SCALe:Y2 <y2_value>
 <y2_value> ::= Y2 value in NR3 format

The :MTESt:SCALe:Y2 command defines the Y2 marker in the coordinate system for mask testing. All Y values of vertices in the coordinate system are defined with respect to the boundaries defined by SCALe:Y1 and SCALe:Y2 according to the following equation:

$$Y = (Y * (Y2 - Y1)) + Y1$$

Thus, if you set Y1 to 100 mV, and Y2 to 1 V, a Y value of 0.100 in a vertex is at 190 mV.

The Y2 value is a voltage value specifying the location of the Y2 marker.

Query Syntax :MTESt:SCALe:Y2?

The :MTESt:SCALe:Y2? query returns the current setting of the Y2 marker.

Return Format <y2_value><NL>
 <y2_value> ::= Y2 value in NR3 format

- See Also**
- ["Introduction to :MTESt Commands"](#) on page 583
 - [":MTESt:SCALe:BIND"](#) on page 608
 - [":MTESt:SCALe:X1"](#) on page 609
 - [":MTESt:SCALe:XDELta"](#) on page 610
 - [":MTESt:SCALe:Y1"](#) on page 611

:MTESt:SOURce

N (see [page 1384](#))

Command Syntax :MTESt:SOURce <source>

<source> ::= CHANnel<n>

<n> ::= 1 to (# analog channels) in NR1 format

The :MTESt:SOURce command selects the channel which is configured by the commands contained in a mask file when it is loaded.

Query Syntax :MTESt:SOURce?

The :MTESt:SOURce? query returns the channel which is configured by the commands contained in the current mask file.

Return Format <source><NL>

<source> ::= {CHAN<n> | NONE}

<n> ::= 1 to (# analog channels) in NR1 format

- See Also**
- ["Introduction to :MTESt Commands"](#) on page 583
 - [":MTESt:AMASK:SOURce"](#) on page 588

:MTESt:TITLe

N (see [page 1384](#))

Query Syntax :MTESt:TITLe?

The :MTESt:TITLe? query returns the mask title which is a string of up to 128 characters. The title is displayed in the mask test dialog box and mask test tab when a mask file is loaded.

Return Format <title><NL>

<title> ::= a string of up to 128 ASCII characters.

See Also • ["Introduction to :MTESt Commands"](#) on page 583

25 :POD Commands

Control all oscilloscope functions associated with groups of digital channels. See "[Introduction to :POD<n> Commands](#)" on page 615.

Table 107 :POD<n> Commands Summary

Command	Query	Options and Query Returns
:POD<n>:DISPlay {{0 OFF} {1 ON}} (see page 617)	:POD<n>:DISPlay? (see page 617)	{0 1} <n> ::= 1-2 in NR1 format
:POD<n>:SIZE <value> (see page 618)	:POD<n>:SIZE? (see page 618)	<value> ::= {SMALl MEDium LARGe}
:POD<n>:THReshold <type>[suffix] (see page 619)	:POD<n>:THReshold? (see page 619)	<n> ::= 1-2 in NR1 format <type> ::= {CMOS ECL TTL <user defined value>} <user defined value> ::= value in NR3 format [suffix] ::= {V mV uV }

Introduction to :POD<n> Commands

<n> ::= {1 | 2}

The POD subsystem commands control the viewing and threshold of groups of digital channels.

POD1 ::= D0-D7

POD2 ::= D8-D15

NOTE

These commands are only valid for the MSO models.

Reporting the Setup

Use :POD1? or :POD2? to query setup information for the POD subsystem.

Return Format

The following is a sample response from the :POD1? query. In this case, the query was issued following a *RST command.

```
:POD1:DISP 0;THR +1.40E+00
```

:POD<n>:DISPlay

N (see [page 1384](#))

Command Syntax :POD<n>:DISPlay <display>

<display> ::= {{1 | ON} | {0 | OFF}}

<n> ::= An integer, 1 or 2, is attached as a suffix to the command and defines the group of channels that are affected by the command.

POD1 ::= D0-D7

POD2 ::= D8-D15

The :POD<n>:DISPlay command turns displaying of the specified group of channels on or off.

NOTE

This command is only valid for the MSO models.

Query Syntax :POD<n>:DISPlay?

The :POD<n>:DISPlay? query returns the current display setting of the specified group of channels.

Return Format <display><NL>

<display> ::= {0 | 1}

- See Also**
- ["Introduction to :POD<n> Commands"](#) on page 615
 - [":DIGital<d>:DISPlay"](#) on page 335
 - [":CHANnel<n>:DISPlay"](#) on page 294
 - [":VIEW"](#) on page 252
 - [":BLANK"](#) on page 224
 - [":STATus"](#) on page 249

:POD<n>:SIZE

N (see [page 1384](#))

Command Syntax :POD<n>:SIZE <value>

<n> ::= An integer, 1 or 2, is attached as a suffix to the command and defines the group of channels that are affected by the command.

POD1 ::= D0-D7

POD2 ::= D8-D15

<value> ::= {SMALl | MEDium | LARGe}

The :POD<n>:SIZE command specifies the size of digital channels on the display. Sizes are set for all pods. Therefore, if you set the size on pod 1 (for example), the same size is set on pod 2 as well.

NOTE

This command is only valid for the MSO models.

Query Syntax :POD<n>:SIZE?

The :POD<n>:SIZE? query returns the digital channels size setting.

Return Format <size_value><NL>

<size_value> ::= {SMAL | MED | LARG}

- See Also**
- ["Introduction to :POD<n> Commands"](#) on page 615
 - [":DIGital<d>:SIZE"](#) on page 338
 - [":DIGital<d>:POSition"](#) on page 337

:POD<n>:THReshold

N (see [page 1384](#))

Command Syntax :POD<n>:THReshold <type>[<suffix>]

<n> ::= An integer, 1 or 2, is attached as a suffix to the command and defines the group of channels that are affected by the command.

<type> ::= {CMOS | ECL | TTL | <user defined value>}

<user defined value> ::= -8.00 to +8.00 in NR3 format

<suffix> ::= {V | mV | uV}

POD1 ::= D0-D7

POD2 ::= D8-D15

TTL ::= 1.4V

CMOS ::= 2.5V

ECL ::= -1.3V

The :POD<n>:THReshold command sets the threshold for the specified group of channels. The threshold is used for triggering purposes and for displaying the digital data as high (above the threshold) or low (below the threshold).

NOTE

This command is only valid for the MSO models.

Query Syntax :POD<n>:THReshold?

The :POD<n>:THReshold? query returns the threshold value for the specified group of channels.

Return Format <threshold><NL>

<threshold> ::= Floating point number in NR3 format

- See Also**
- ["Introduction to :POD<n> Commands"](#) on page 615
 - [":DIGital<d>:THReshold"](#) on page 339
 - [":TRIGger\[:EDGE\]:LEVel"](#) on page 1123

Example Code

```
' THRESHOLD - This command is used to set the voltage threshold for
' the waveforms. There are three preset values (TTL, CMOS, and ECL)
' and you can also set a user-defined threshold value between
' -8.0 volts and +8.0 volts.
'
' In this example, we set channels 0-7 to CMOS, then set channels
' 8-15 to a user-defined 2.0 volts, and then set the external trigger
' to TTL. Of course, you only need to set the thresholds for the
' channels you will be using in your program.
```

```
' Set channels 0-7 to CMOS threshold.
myScope.WriteString ":POD1:THRESHOLD CMOS"

' Set channels 8-15 to 2.0 volts.
myScope.WriteString ":POD2:THRESHOLD 2.0"

' Set external channel to TTL threshold (short form).
myScope.WriteString ":TRIG:LEV TTL,EXT"
```

See complete example programs at: [Chapter 42](#), "Programming Examples," starting on page 1393

26 :POWer Commands

These :POWer commands are available when the DSOX3PWR power measurements and analysis application is licensed and enabled.

Table 108: :POWer Commands Summary

Command	Query	Options and Query Returns
n/a	:POWer:CLResponse? (see page 628)	n/a
:POWer:CLResponse:APP Ly (see page 629)	n/a	n/a
n/a	:POWer:CLResponse:DAT A? (see page 630)	<binary_block> ::= comma-separated data with newlines at the end of each row
:POWer:CLResponse:FRE Quency:MODE <mode> (see page 631)	:POWer:CLResponse:FRE Quency:MODE? (see page 631)	<mode> ::= {SWEep SINGle}
:POWer:CLResponse:FRE Quency:START <value>[suffix] (see page 632)	:POWer:CLResponse:FRE Quency:START? (see page 632)	<value> ::= {20 100 1000 10000 100000 1000000 10000000} [suffix] ::= {Hz kHz MHz}
:POWer:CLResponse:FRE Quency:STOP <value>[suffix] (see page 633)	:POWer:CLResponse:FRE Quency:STOP? (see page 633)	<value> ::= {100 1000 10000 100000 1000000 10000000 20000000} [suffix] ::= {Hz kHz MHz}
:POWer:CLResponse:PPD ecade <pts> (see page 634)	:POWer:CLResponse:PPD ecade? (see page 634)	<pts> ::= {10 20 30 40 50}
:POWer:CLResponse:SOU Rce:INPut <source> (see page 635)	:POWer:CLResponse:SOU Rce:INPut? (see page 635)	<source> ::= CHANnel<n> <n> ::= 1 to (# analog channels) in NR1 format
:POWer:CLResponse:SOU Rce:OUTPut <source> (see page 636)	:POWer:CLResponse:SOU Rce:OUTPut? (see page 636)	<source> ::= CHANnel<n> <n> ::= 1 to (# analog channels) in NR1 format

Table 108 :POWer Commands Summary (continued)

Command	Query	Options and Query Returns
:POWer:CLResponse:WGEN:LOAD <impedance> (see page 637)	:POWer:CLResponse:WGEN:LOAD? (see page 637)	<impedance> ::= {ONEMeg FIFTy}
:POWer:CLResponse:WGEN:VOLTage <amplitude>[,<range>] (see page 638)	:POWer:CLResponse:WGEN:VOLTage? [<range>] (see page 638)	<amplitude> ::= amplitude in volts in NR3 format <range> ::= {F20HZ F100HZ F1KHZ F10KHZ F100KHZ F1MHZ F10MHZ F20MHZ}
:POWer:CLResponse:WGEN:VOLTage:PROFile {{0 OFF} {1 ON}} (see page 639)	:POWer:CLResponse:WGEN:VOLTage:PROFile? (see page 639)	{0 1}
:POWer:DESKew (see page 640)	n/a	n/a
:POWer:EFFiciency:APPLy (see page 641)	n/a	n/a
:POWer:EFFiciency:TYPE <type> (see page 642)	:POWer:EFFiciency:TYPE? (see page 642)	<type> ::= {DCDC DCAC ACDC ACAC}
:POWer:ENABLE {{0 OFF} {1 ON}} (see page 643)	:POWer:ENABLE? (see page 643)	{0 1}
:POWer:HARMonics:APPLy (see page 644)	n/a	n/a
n/a	:POWer:HARMonics:DATA? (see page 645)	<binary_block> ::= comma-separated data with newlines at the end of each row
:POWer:HARMonics:DISP lay <display> (see page 646)	:POWer:HARMonics:DISP lay? (see page 646)	<display> ::= {TABLE BAR OFF}
n/a	:POWer:HARMonics:FAIL count? (see page 647)	<count> ::= integer in NR1 format
:POWer:HARMonics:LINE <frequency> (see page 648)	:POWer:HARMonics:LINE? (see page 648)	<frequency> ::= {F50 F60 F400 AUTO}
n/a	:POWer:HARMonics:POWerfactor? (see page 649)	<value> ::= Class C power factor in NR3 format

Table 108 :POWer Commands Summary (continued)

Command	Query	Options and Query Returns
:POWer:HARMonics:RPOWer <source> (see page 650)	:POWer:HARMonics:RPOWer? (see page 650)	<source> ::= {MEASured USER}
:POWer:HARMonics:RPOWer:USER <value> (see page 651)	:POWer:HARMonics:RPOWer:USER? (see page 651)	<value> ::= Watts from 1.0 to 600.0 in NR3 format
n/a	:POWer:HARMonics:RUNCout? (see page 652)	<count> ::= integer in NR1 format
:POWer:HARMonics:STANdard <class> (see page 653)	:POWer:HARMonics:STANdard? (see page 653)	<class> ::= {A B C D}
n/a	:POWer:HARMonics:STATus? (see page 654)	<status> ::= {PASS FAIL UNTested}
n/a	:POWer:HARMonics:THD? (see page 655)	<value> ::= Total Harmonics Distortion in NR3 format
:POWer:INRush:APPLy (see page 656)	n/a	n/a
:POWer:INRush:EXIT (see page 657)	n/a	n/a
:POWer:INRush:NEXT (see page 658)	n/a	n/a
:POWer:ITYPE <type> (see page 659)	:POWer:ITYPE? (see page 659)	<type> ::= {DC AC}
:POWer:MODulation:APPLy (see page 660)	n/a	n/a
:POWer:MODulation:SOUrce <source> (see page 661)	:POWer:MODulation:SOUrce? (see page 661)	<source> ::= {V I}
:POWer:MODulation:TYP E <modulation> (see page 662)	:POWer:MODulation:TYP E? (see page 662)	<modulation> ::= {VAverage ACRMs VRATio PERiod FREQuency PWIDith NWIDth DUTYcycle RISetime FALLtime}
:POWer:ONOFF:APPLy (see page 663)	n/a	n/a
:POWer:ONOFF:EXIT (see page 664)	n/a	n/a
:POWer:ONOFF:NEXT (see page 665)	n/a	n/a

Table 108:POWer Commands Summary (continued)

Command	Query	Options and Query Returns
:POWer:ONOff:TEST {{0 OFF} {1 ON}} (see page 666)	:POWer:ONOff:TEST? (see page 666)	{0 1}
:POWer:ONOff:THReshol ds <type>, <input_thr>, <output_thr> (see page 667)	:POWer:ONOff:THReshol ds? <type> (see page 667)	<type> ::= {0 1} <input_thr> ::= percent from 0-100 in NR1 format <output_thr> ::= percent from 0-100 in NR1 format
n/a	:POWer:PSRR? (see page 669)	n/a
:POWer:PSRR:APPLy (see page 670)	n/a	n/a
n/a	:POWer:PSRR:DATA? (see page 671)	<binary_block> ::= comma-separated data with newlines at the end of each row
:POWer:PSRR:FREQuency :MAXimum <value>[suffix] (see page 672)	:POWer:PSRR:FREQuency :MAXimum? (see page 672)	<value> ::= {10 100 1000 10000 100000 1000000 10000000 20000000} [suffix] ::= {Hz kHz MHz}
:POWer:PSRR:FREQuency :MINimum <value>[suffix] (see page 673)	:POWer:PSRR:FREQuency :MINimum? (see page 673)	<value> ::= {1 10 100 1000 10000 100000 1000000 10000000} [suffix] ::= {Hz kHz MHz}
:POWer:PSRR:FREQuency :MODE <mode> (see page 674)	:POWer:PSRR:FREQuency :MODE? (see page 674)	<mode> ::= {SWEep SINGLE}
:POWer:PSRR:PPDecade <pts> (see page 675)	:POWer:PSRR:PPDecade? (see page 675)	<pts> ::= {10 20 30 40 50}
:POWer:PSRR:SOURce:IN Put <source> (see page 676)	:POWer:PSRR:SOURce:IN Put? (see page 676)	<source> ::= CHANnel<n> <n> ::= 1 to (# analog channels) in NR1 format
:POWer:PSRR:SOURce:OU TPut <source> (see page 677)	:POWer:PSRR:SOURce:OU TPut? (see page 677)	<source> ::= CHANnel<n> <n> ::= 1 to (# analog channels) in NR1 format
:POWer:PSRR:WGEN:LOAD <impedance> (see page 678)	:POWer:PSRR:WGEN:LOAD ? (see page 678)	<impedance> ::= {ONEMeg FIFTy}

Table 108 :POWer Commands Summary (continued)

Command	Query	Options and Query Returns
:POWer:PSRR:WGEN:VOLT age <amplitude> [, <range>] (see page 679)	:POWer:PSRR:WGEN:VOLT age? [<range>] (see page 679)	<amplitude> ::= amplitude in volts in NR3 format <range> ::= {F20HZ F100HZ F1KHZ F10KHZ F100KHZ F1MHZ F10MHZ F20MHZ}
:POWer:PSRR:WGEN:VOLT age:PROFile {{0 OFF} {1 ON}} (see page 680)	:POWer:PSRR:WGEN:VOLT age:PROFile? (see page 680)	{0 1}
:POWer:QUALity:APPLy (see page 681)	n/a	n/a
:POWer:RIPPlE:APPLy (see page 682)	n/a	n/a
:POWer:SIGNals:AUTose tup <analysis> (see page 683)	n/a	<analysis> ::= {HARMonics EFFiciency RIPPlE MODulation QUALity SLEW SWITCh RDSVce}
:POWer:SIGNals:CYCLes :HARMonics <count> (see page 684)	:POWer:SIGNals:CYCLes :HARMonics? (see page 684)	<count> ::= integer in NR1 format Legal values are 1 to 100.
:POWer:SIGNals:CYCLes :QUALity <count> (see page 685)	:POWer:SIGNals:CYCLes :QUALity? (see page 685)	<count> ::= integer in NR1 format Legal values are 1 to 100.
:POWer:SIGNals:DURati on:EFFiciency <value> [suffix] (see page 686)	:POWer:SIGNals:DURati on:EFFiciency? (see page 686)	<value> ::= value in NR3 format [suffix] ::= {s ms us ns}
:POWer:SIGNals:DURati on:MODulation <value> [suffix] (see page 687)	:POWer:SIGNals:DURati on:MODulation? (see page 687)	<value> ::= value in NR3 format [suffix] ::= {s ms us ns}
:POWer:SIGNals:DURati on:ONOff:OFF <value> [suffix] (see page 688)	:POWer:SIGNals:DURati on:ONOff:OFF? (see page 688)	<value> ::= value in NR3 format [suffix] ::= {s ms us ns}
:POWer:SIGNals:DURati on:ONOff:ON <value> [suffix] (see page 689)	:POWer:SIGNals:DURati on:ONOff:ON? (see page 689)	<value> ::= value in NR3 format [suffix] ::= {s ms us ns}

Table 108 :POWer Commands Summary (continued)

Command	Query	Options and Query Returns
:POWer:SIGNals:DURati on:RIPPlE <value>[suffix] (see page 690)	:POWer:SIGNals:DURati on:RIPPlE? (see page 690)	<value> ::= value in NR3 format [suffix] ::= {s ms us ns}
:POWer:SIGNals:DURati on:TRANSient <value>[suffix] (see page 691)	:POWer:SIGNals:DURati on:TRANSient? (see page 691)	<value> ::= value in NR3 format [suffix] ::= {s ms us ns}
:POWer:SIGNals:IEXPe cted <value>[suffix] (see page 692)	:POWer:SIGNals:IEXPe cted? (see page 692)	<value> ::= Expected current value in NR3 format [suffix] ::= {A mA}
:POWer:SIGNals:OVERsh oot <percent> (see page 693)	:POWer:SIGNals:OVERsh oot? (see page 693)	<percent> ::= percent of overshoot value in NR1 format [suffix] ::= {V mV}
:POWer:SIGNals:VMAXim um:INRush <value>[suffix] (see page 694)	:POWer:SIGNals:VMAXim um:INRush? (see page 694)	<value> ::= Maximum expected input Voltage in NR3 format [suffix] ::= {V mV}
:POWer:SIGNals:VMAXim um:ONOFF:OFF <value>[suffix] (see page 695)	:POWer:SIGNals:VMAXim um:ONOFF:OFF? (see page 695)	<value> ::= Maximum expected input Voltage in NR3 format [suffix] ::= {V mV}
:POWer:SIGNals:VMAXim um:ONOFF:ON <value>[suffix] (see page 696)	:POWer:SIGNals:VMAXim um:ONOFF:ON? (see page 696)	<value> ::= Maximum expected input Voltage in NR3 format [suffix] ::= {V mV}
:POWer:SIGNals:VSTead y:ONOFF:OFF <value>[suffix] (see page 697)	:POWer:SIGNals:VSTead y:ONOFF:OFF? (see page 697)	<value> ::= Expected steady stage output Voltage value in NR3 format [suffix] ::= {V mV}
:POWer:SIGNals:VSTead y:ONOFF:ON <value>[suffix] (see page 698)	:POWer:SIGNals:VSTead y:ONOFF:ON? (see page 698)	<value> ::= Expected steady stage output Voltage value in NR3 format [suffix] ::= {V mV}
:POWer:SIGNals:VSTead y:TRANSient <value>[suffix] (see page 699)	:POWer:SIGNals:VSTead y:TRANSient? (see page 699)	<value> ::= Expected steady stage output Voltage value in NR3 format [suffix] ::= {V mV}
:POWer:SIGNals:SOURce :CURRent<i> <source> (see page 700)	:POWer:SIGNals:SOURce :CURRent<i>? (see page 700)	<i> ::= 1, 2 in NR1 format <source> ::= CHANnel<n> <n> ::= 1 to (# analog channels) in NR1 format

Table 108 :POWer Commands Summary (continued)

Command	Query	Options and Query Returns
:POWer:SIGNals:SOURce :VOLTage<i> <source> (see page 701)	:POWer:SIGNals:SOURce :VOLTage<i>? (see page 701)	<i> ::= 1, 2 in NR1 format <source> ::= CHANnel<n> <n> ::= 1 to (# analog channels) in NR1 format
:POWer:SLEW:APPLy (see page 702)	n/a	n/a
:POWer:SLEW:SOURce <source> (see page 703)	:POWer:SLEW:SOURce? (see page 703)	<source> ::= {V I}
:POWer:SWITCh:APPLy (see page 704)	n/a	n/a
:POWer:SWITCh:CONduct ion <conduction> (see page 705)	:POWer:SWITCh:CONduct ion? (see page 705)	<conduction> ::= {WAVEform RDS VCE}
:POWer:SWITCh:IREFere nce <percent> (see page 706)	:POWer:SWITCh:IREFere nce? (see page 706)	<percent> ::= percent in NR1 format
:POWer:SWITCh:RDS <value>[suffix] (see page 707)	:POWer:SWITCh:RDS? (see page 707)	<value> ::= Rds(on) value in NR3 format [suffix] ::= {OHM mOHM}
:POWer:SWITCh:VCE <value>[suffix] (see page 708)	:POWer:SWITCh:VCE? (see page 708)	<value> ::= Vce(sat) value in NR3 format [suffix] ::= {V mV}
:POWer:SWITCh:VREFere nce <percent> (see page 709)	:POWer:SWITCh:VREFere nce? (see page 709)	<percent> ::= percent in NR1 format
:POWer:TRANSient:APPL y (see page 710)	n/a	n/a
:POWer:TRANSient:EXIT (see page 711)	n/a	n/a
:POWer:TRANSient:IINi tial <value>[suffix] (see page 712)	:POWer:TRANSient:IINi tial? (see page 712)	<value> ::= Initial current value in NR3 format [suffix] ::= {A mA}
:POWer:TRANSient:INEW <value>[suffix] (see page 713)	:POWer:TRANSient:INEW ? (see page 713)	<value> ::= New current value in NR3 format [suffix] ::= {A mA}
:POWer:TRANSient:NEXT (see page 714)	n/a	n/a

:POWer:CLResponse

N (see [page 1384](#))

Query Syntax :POWer:CLResponse?

The :POWer:CLResponse? query returns the Control Loop Response (Bode) power analysis settings.

Return Format <settings_string><NL>

For example, the query returns the following string when issued after the *RST command.

```
:POW:CLR:SOUR:INP CHAN1;OUTP CHAN2;:POW:CLR:FREQ:STAR +100E+00;
STOP +20.000000E+06;:POW:CLR:WGEN:VOLT +200.0E-03;LOAD FIFT
```

- See Also**
- [":POWer:CLResponse:APPLY"](#) on page 629
 - [":POWer:CLResponse:DATA"](#) on page 630
 - [":POWer:CLResponse:FREQuency:MODE"](#) on page 631
 - [":POWer:CLResponse:FREQuency:START"](#) on page 632
 - [":POWer:CLResponse:FREQuency:STOP"](#) on page 633
 - [":POWer:CLResponse:PPDecade"](#) on page 634
 - [":POWer:CLResponse:SOURce:INPut"](#) on page 635
 - [":POWer:CLResponse:SOURce:OUTPut"](#) on page 636
 - [":POWer:CLResponse:WGEN:LOAD"](#) on page 637
 - [":POWer:CLResponse:WGEN:VOLTage"](#) on page 638
 - [":POWer:CLResponse:WGEN:VOLTage:PROFile"](#) on page 639

:POWer:CLResponse:APPLy

N (see [page 1384](#))

Command Syntax :POWer:CLResponse:APPLy

The :POWer:CLResponse:APPLy command performs the control loop response (Bode) analysis to help you determine the margin of a control loop.

A Bode plot measurement plots gain or phase (selected by the :POWer:CLResponse:VIEW command) as a function of frequency.

This control loop response analysis requires an input sine wave (from the oscilloscope's waveform generator, Vi) be swept from a low to a high frequency while measuring Vi and Vo RMS voltages at each step frequency, using two channels of the oscilloscope.

For a gain plot, gain (A, in dB units) at each step frequency is computed as $20\text{Log}(V_o/V_i)$ and plotted using a math function waveform.

For a phase plot, the phase difference between the channels is measured at each step frequency. Phase measurements and plots are only possible if the input and output waveforms exceed 1 division peak-to-peak (>1 mVpp).

It takes some time for the frequency sweep analysis to complete. You can query bit 0 of the Standard Event Status Register (*ESR?) to find out when the analysis is complete.

- See Also**
- ["*ESR \(Standard Event Status Register\)"](#) on page 194
 - [":POWer:CLResponse"](#) on page 628
 - [":POWer:CLResponse:DATA"](#) on page 630
 - [":POWer:CLResponse:FREQuency:MODE"](#) on page 631
 - [":POWer:CLResponse:FREQuency:START"](#) on page 632
 - [":POWer:CLResponse:FREQuency:STOP"](#) on page 633
 - [":POWer:CLResponse:PPDecade"](#) on page 634
 - [":POWer:CLResponse:SOURce:INPut"](#) on page 635
 - [":POWer:CLResponse:SOURce:OUTPut"](#) on page 636
 - [":POWer:CLResponse:WGEN:LOAD"](#) on page 637
 - [":POWer:CLResponse:WGEN:VOLTage"](#) on page 638
 - [":POWer:CLResponse:WGEN:VOLTage:PROFile"](#) on page 639

:POWer:CLResponse:DATA

N (see [page 1384](#))

Query Syntax :POWer:CLResponse:DATA?

The :POWer:CLResponse:DATA? query returns data from the Control Loop Response (Bode) power analysis.

The comma-separated value format is suitable for spreadsheet analysis.

Return Format <binary_block><NL>

<binary_block> ::= comma-separated data with newlines at the end of each row

- See Also**
- [":POWer:CLResponse"](#) on page 628
 - [":POWer:CLResponse:APPLY"](#) on page 629
 - [":POWer:CLResponse:FREQuency:MODE"](#) on page 631
 - [":POWer:CLResponse:FREQuency:START"](#) on page 632
 - [":POWer:CLResponse:FREQuency:STOP"](#) on page 633
 - [":POWer:CLResponse:PPDecade"](#) on page 634
 - [":POWer:CLResponse:SOURce:INPut"](#) on page 635
 - [":POWer:CLResponse:SOURce:OUTPut"](#) on page 636
 - [":POWer:CLResponse:WGEN:LOAD"](#) on page 637
 - [":POWer:CLResponse:WGEN:VOLTage"](#) on page 638
 - [":POWer:CLResponse:WGEN:VOLTage:PROFile"](#) on page 639

:POWer:CLResponse:FREQuency:MODE

N (see [page 1384](#))

Command Syntax :POWer:CLResponse:FREQuency:MODE <mode>

<mode> ::= {SWEep | SINGle}

The :POWer:CLResponse:FREQuency:MODE command specifies whether the analysis should be performed by sweeping through a range of frequencies (SWEep) or at a single frequency (SINGle).

The SINGle mode is useful for evaluating amplitudes at a single frequency, for example, near the expected 0 dB cross-over frequency. After running the test at a single frequency, you can manually adjust (increase) the waveform generator's amplitude until you begin to observe distortion in the waveforms on the oscilloscope's display. You can then use that amplitude at all frequencies in SWEep mode, or you can evaluate amplitudes at other frequencies in order to determine an optimized amplitude profile (see :POWer:CLResponse:WGEN:VOLTage:PROFile).

Query Syntax :POWer:CLResponse:FREQuency:MODE?

The :POWer:CLResponse:FREQuency:MODE? query returns the frequency mode setting.

Return Format <mode><NL>

<mode> ::= {SWE | SING}

- See Also**
- [":POWer:CLResponse"](#) on page 628
 - [":POWer:CLResponse:APPLY"](#) on page 629
 - [":POWer:CLResponse:DATA"](#) on page 630
 - [":POWer:CLResponse:FREQuency:START"](#) on page 632
 - [":POWer:CLResponse:FREQuency:STOP"](#) on page 633
 - [":POWer:CLResponse:PPDecade"](#) on page 634
 - [":POWer:CLResponse:SOURce:INPut"](#) on page 635
 - [":POWer:CLResponse:SOURce:OUTPut"](#) on page 636
 - [":POWer:CLResponse:WGEN:LOAD"](#) on page 637
 - [":POWer:CLResponse:WGEN:VOLTage"](#) on page 638
 - [":POWer:CLResponse:WGEN:VOLTage:PROFile"](#) on page 639

:POWer:CLResponse:FREQuency:START

N (see [page 1384](#))

Command Syntax `:POWer:CLResponse:FREQuency:START <value>[suffix]`
`<value> ::= {20 | 100 | 1000 | 10000 | 100000 | 1000000 | 10000000}`
`[suffix] ::= {Hz | kHz | MHz}`

The `:POWer:CLResponse:FREQuency:START` command sets the frequency sweep start value. The control loop response analysis is displayed on a log scale Bode plot, so you can select from decade values in addition to the minimum frequency of 20 Hz.

Query Syntax `:POWer:CLResponse:FREQuency:START?`

The `:POWer:CLResponse:FREQuency:START?` query returns the frequency sweep start setting.

Return Format `<value><NL>`
`<value> ::= {20 | 100 | 1000 | 10000 | 100000 | 1000000 | 10000000}`

- See Also**
- [":POWer:CLResponse"](#) on page 628
 - [":POWer:CLResponse:APPLy"](#) on page 629
 - [":POWer:CLResponse:DATA"](#) on page 630
 - [":POWer:CLResponse:FREQuency:MODE"](#) on page 631
 - [":POWer:CLResponse:FREQuency:STOP"](#) on page 633
 - [":POWer:CLResponse:PPDecade"](#) on page 634
 - [":POWer:CLResponse:SOURce:INPut"](#) on page 635
 - [":POWer:CLResponse:SOURce:OUTPut"](#) on page 636
 - [":POWer:CLResponse:WGEN:LOAD"](#) on page 637
 - [":POWer:CLResponse:WGEN:VOLTage"](#) on page 638
 - [":POWer:CLResponse:WGEN:VOLTage:PROFile"](#) on page 639

:POWer:CLResponse:FREQuency:STOP

N (see [page 1384](#))

Command Syntax :POWer:CLResponse:FREQuency:STOP <value>[suffix]

<value> ::= {100 | 1000 | 10000 | 100000 | 1000000 | 10000000 | 20000000
}

[suffix] ::= {Hz | kHz | MHz}

The :POWer:CLResponse:FREQuency:STOP command sets the frequency sweep stop value. The control loop response analysis is displayed on a log scale Bode plot, so you can select from decade values in addition to the maximum frequency of 20 MHz.

Query Syntax :POWer:CLResponse:FREQuency:STOP?

The :POWer:CLResponse:FREQuency:STOP? query returns the frequency sweep stop setting.

Return Format <value><NL>

<value> ::= {100 | 1000 | 10000 | 100000 | 1000000 | 10000000 | 20000000
}

- See Also**
- [":POWer:CLResponse"](#) on page 628
 - [":POWer:CLResponse:APPLY"](#) on page 629
 - [":POWer:CLResponse:DATA"](#) on page 630
 - [":POWer:CLResponse:FREQuency:MODE"](#) on page 631
 - [":POWer:CLResponse:FREQuency:START"](#) on page 632
 - [":POWer:CLResponse:PPDecade"](#) on page 634
 - [":POWer:CLResponse:SOURce:INPut"](#) on page 635
 - [":POWer:CLResponse:SOURce:OUTPut"](#) on page 636
 - [":POWer:CLResponse:WGEN:LOAD"](#) on page 637
 - [":POWer:CLResponse:WGEN:VOLTage"](#) on page 638
 - [":POWer:CLResponse:WGEN:VOLTage:PROFile"](#) on page 639

:POWer:CLResponse:PPDecade

N (see [page 1384](#))

Command Syntax :POWer:CLResponse:PPDecade <pts>
 <pts> ::= {10 | 20 | 30 | 40 | 50}

The :POWer:CLResponse:PPDecade command selects the number of frequency test points per decade (in the log scale).

Query Syntax :POWer:CLResponse:PPDecade?

The :POWer:CLResponse:PPDecade? query returns the points per decade setting.

Return Format <pts><NL>
 <pts> ::= {10 | 20 | 30 | 40 | 50}

- See Also**
- [":POWer:CLResponse"](#) on page 628
 - [":POWer:CLResponse:APPLY"](#) on page 629
 - [":POWer:CLResponse:DATA"](#) on page 630
 - [":POWer:CLResponse:FREQuency:MODE"](#) on page 631
 - [":POWer:CLResponse:FREQuency:START"](#) on page 632
 - [":POWer:CLResponse:FREQuency:STOP"](#) on page 633
 - [":POWer:CLResponse:SOURce:INPut"](#) on page 635
 - [":POWer:CLResponse:SOURce:OUTPut"](#) on page 636
 - [":POWer:CLResponse:WGEN:LOAD"](#) on page 637
 - [":POWer:CLResponse:WGEN:VOLTage"](#) on page 638
 - [":POWer:CLResponse:WGEN:VOLTage:PROFile"](#) on page 639

:POWer:CLResponse:SOURce:INPut

N (see [page 1384](#))

Command Syntax :POWer:CLResponse:SOURce:INPut <source>

<source> ::= CHANnel<n>

<n> ::= 1 to (# analog channels) in NR1 format

The :POWer:CLResponse:SOURce:INPut command selects the oscilloscope channel that is probing the power supply input.

Query Syntax :POWer:CLResponse:SOURce:INPut?

The :POWer:CLResponse:SOURce:INPut? query returns the channel selection.

Return Format <source><NL>

<source> ::= CHAN<n>

- See Also**
- [":POWer:CLResponse"](#) on page 628
 - [":POWer:CLResponse:APPLY"](#) on page 629
 - [":POWer:CLResponse:DATA"](#) on page 630
 - [":POWer:CLResponse:FREQuency:MODE"](#) on page 631
 - [":POWer:CLResponse:FREQuency:START"](#) on page 632
 - [":POWer:CLResponse:FREQuency:STOP"](#) on page 633
 - [":POWer:CLResponse:PPDecade"](#) on page 634
 - [":POWer:CLResponse:SOURce:OUTPut"](#) on page 636
 - [":POWer:CLResponse:WGEN:LOAD"](#) on page 637
 - [":POWer:CLResponse:WGEN:VOLTage"](#) on page 638
 - [":POWer:CLResponse:WGEN:VOLTage:PROFile"](#) on page 639

:POWer:CLResponse:SOURce:OUTPut

N (see [page 1384](#))

Command Syntax :POWer:CLResponse:SOURce:OUTPut <source>

<source> ::= CHANnel<n>

<n> ::= 1 to (# analog channels) in NR1 format

The :POWer:CLResponse:SOURce:OUTPut command selects the oscilloscope channel that is probing the power supply output.

Query Syntax :POWer:CLResponse:SOURce:OUTPut?

The :POWer:CLResponse:SOURce:OUTPut? query returns the channel selection.

Return Format <source><NL>

<source> ::= CHAN<n>

- See Also**
- [":POWer:CLResponse"](#) on page 628
 - [":POWer:CLResponse:APPLY"](#) on page 629
 - [":POWer:CLResponse:DATA"](#) on page 630
 - [":POWer:CLResponse:FREQuency:MODE"](#) on page 631
 - [":POWer:CLResponse:FREQuency:START"](#) on page 632
 - [":POWer:CLResponse:FREQuency:STOP"](#) on page 633
 - [":POWer:CLResponse:PPDecade"](#) on page 634
 - [":POWer:CLResponse:SOURce:INPut"](#) on page 635
 - [":POWer:CLResponse:WGEN:LOAD"](#) on page 637
 - [":POWer:CLResponse:WGEN:VOLTage"](#) on page 638
 - [":POWer:CLResponse:WGEN:VOLTage:PROFile"](#) on page 639

:POWer:CLResponse:WGEN:LOAD

N (see [page 1384](#))

Command Syntax :POWer:CLResponse:WGEN:LOAD <impedance>
 <impedance> ::= {ONEMeg | FIFTy}

The :POWer:CLResponse:WGEN:LOAD command sets the waveform generator expected output load impedance.

The output impedance of the Gen Out signal is fixed at 50 ohms. However, the output load selection lets the waveform generator display the correct amplitude and offset levels for the expected output load. If the actual load impedance is different than the selected value, the displayed amplitude and offset levels will be incorrect.

Query Syntax :POWer:CLResponse:WGEN:LOAD?

The :POWer:CLResponse:WGEN:LOAD? query returns the waveform generator expected output load impedance setting.

Return Format <impedance><NL>
 <impedance> ::= {ONEM | FIFT}

- See Also**
- [":POWer:CLResponse"](#) on page 628
 - [":POWer:CLResponse:APPLY"](#) on page 629
 - [":POWer:CLResponse:DATA"](#) on page 630
 - [":POWer:CLResponse:FREQuency:MODE"](#) on page 631
 - [":POWer:CLResponse:FREQuency:START"](#) on page 632
 - [":POWer:CLResponse:FREQuency:STOP"](#) on page 633
 - [":POWer:CLResponse:PPDecade"](#) on page 634
 - [":POWer:CLResponse:SOURce:INPut"](#) on page 635
 - [":POWer:CLResponse:SOURce:OUTPut"](#) on page 636
 - [":POWer:CLResponse:WGEN:VOLTage"](#) on page 638
 - [":POWer:CLResponse:WGEN:VOLTage:PROFile"](#) on page 639

:POWer:CLResponse:WGEN:VOLTage

N (see [page 1384](#))

Command Syntax :POWer:CLResponse:WGEN:VOLTage <amplitude>[,<range>]

<amplitude> ::= amplitude in volts in NR3 format

<range> ::= {F20HZ | F100HZ | F1KHZ | F10KHZ | F100KHZ | F1MHZ
| F10MHZ | F20MHZ}

The :POWer:CLResponse:WGEN:VOLTage command sets the waveform generator output amplitude(s).

When the waveform generator amplitude profile is enabled (with the :POWer:CLResponse:WGEN:VOLTage:PROFile command), you can set an initial ramp amplitude for each frequency range.

Without the <range> parameter, this command sets the waveform generator output amplitude used when the amplitude profile is disabled.

Query Syntax :POWer:PSRR:WGEN:VOLTage? [<range>]

The :POWer:CLResponse:WGEN:VOLTage? query returns the waveform generator output amplitude setting(s).

Return Format <amplitude><NL>

<amplitude> ::= amplitude in volts in NR3 format

- See Also**
- [":POWer:CLResponse"](#) on page 628
 - [":POWer:CLResponse:APPLY"](#) on page 629
 - [":POWer:CLResponse:DATA"](#) on page 630
 - [":POWer:CLResponse:FREQuency:MODE"](#) on page 631
 - [":POWer:CLResponse:FREQuency:START"](#) on page 632
 - [":POWer:CLResponse:FREQuency:STOP"](#) on page 633
 - [":POWer:CLResponse:PPDecade"](#) on page 634
 - [":POWer:CLResponse:SOURce:INPut"](#) on page 635
 - [":POWer:CLResponse:SOURce:OUTPut"](#) on page 636
 - [":POWer:CLResponse:WGEN:LOAD"](#) on page 637
 - [":POWer:CLResponse:WGEN:VOLTage:PROFile"](#) on page 639

:POWer:CLResponse:WGEN:VOLTage:PROFile

N (see [page 1384](#))

Command Syntax :POWer:CLResponse:WGEN:VOLTage:PROFile {{0 | OFF} | {1 | ON}}

The :POWer:CLResponse:WGEN:VOLTage:PROFile command enables or disables the ability to set initial waveform generator ramp amplitudes for each frequency range.

With amplitude profiling, you can use lower amplitudes at frequencies where the device under test (DUT) is sensitive to distortion and use higher amplitudes where the DUT is less sensitive to distortion. Power supply feedback networks are typically most sensitive near the 0 dB cross-over frequency.

You can often observe distortions during the test. If the input test sine wave begins to look lopsided, clipped, or somewhat triangular in shape (nonsinusoidal), you are probably encountering distortion due to overdriving your DUT. Optimizing test amplitudes to achieve the best dynamic range measurements is often an iterative process of running your frequency response measurements multiple times.

Query Syntax :POWer:CLResponse:WGEN:VOLTage:PROFile?

The :POWer:CLResponse:WGEN:VOLTage:PROFile? query returns the voltage profile setting.

Return Format <setting><NL>
<setting> ::= {0 | 1}

- See Also**
- [":POWer:CLResponse"](#) on page 628
 - [":POWer:CLResponse:APPLY"](#) on page 629
 - [":POWer:CLResponse:DATA"](#) on page 630
 - [":POWer:CLResponse:FREQuency:MODE"](#) on page 631
 - [":POWer:CLResponse:FREQuency:START"](#) on page 632
 - [":POWer:CLResponse:FREQuency:STOP"](#) on page 633
 - [":POWer:CLResponse:PPDecade"](#) on page 634
 - [":POWer:CLResponse:SOURce:INPut"](#) on page 635
 - [":POWer:CLResponse:SOURce:OUTPut"](#) on page 636
 - [":POWer:CLResponse:WGEN:LOAD"](#) on page 637
 - [":POWer:CLResponse:WGEN:VOLTage"](#) on page 638

:POWer:DESKew

N (see [page 1384](#))

Command Syntax :POWer:DESKew

The :POWer:DESKew command launches the auto deskew process on the oscilloscope.

Before sending this command:

- 1 Demagnetize and zero-adjust the current probe.
Refer to the current probe's documentation for instructions on how to do this.
- 2 Make connections to the U1880A deskew fixture as described in the oscilloscope's connection dialog or in the *DSOX4PWR Power Measurement Application User's Guide*.
- 3 Make sure the voltage probe and current probe channels are specified appropriately using the :POWer:SIGNals:SOURce:VOLTage1 and :POWer:SIGNals:SOURce:CURRent1 commands.

NOTE

Use the lowest attenuation setting on the high voltage differential probes whenever possible because the voltage levels on the deskew fixture are very small. Using a higher attenuation setting may yield inaccurate skew values (and affect the measurements made) because the noise level is magnified as well.

The deskew values are saved in the oscilloscope until a factory default or secure erase is performed. The next time you run the Power Application, you can use the saved deskew values or perform the deskew again.

Generally, you need to perform the deskew again when part of the test setup changes (for example, a different probe, different oscilloscope channel, etc.) or when the ambient temperature has changed.

- See Also**
- **":POWer:SIGNals:SOURce:VOLTage<i>"** on page 701
 - **":POWer:SIGNals:SOURce:CURRent<i>"** on page 700

:POWer:EFFiciency:APPLy

N (see [page 1384](#))

Command Syntax :POWer:EFFiciency:APPLy

The :POWer:EFFiciency:APPLy command applies the efficiency power analysis.

Efficiency analysis tests the overall efficiency of the power supply by measuring the output power over the input power.

NOTE

Efficiency analysis requires a 4-channel oscilloscope because input voltage, input current, output voltage, and output current are measured.

- See Also**
- [":POWer:EFFiciency:TYPE"](#) on page 642
 - [":MEASure:EFFiciency"](#) on page 565
 - [":MEASure:IPOWer"](#) on page 568
 - [":MEASure:OPOWer"](#) on page 571

:POWer:EFFiciency:TYPE

N (see [page 1384](#))

Command Syntax :POWer:EFFiciency:TYPE <type>

<type> ::= {DCDC | DCAC | ACDC | ACAC}

The :POWer:EFFiciency:TYPE command specifies the type of power that is being converted from the input to the output. This selection affects how the efficiency is measured.

Query Syntax :POWer:EFFiciency:TYPE?

The :POWer:EFFiciency:TYPE? query returns the currently specified type setting.

Return Format <type><NL>

<type> ::= {DCDC | DCAC | ACDC | ACAC}

- See Also**
- [":POWer:EFFiciency:APPLY"](#) on page 641
 - [":MEASure:EFFiciency"](#) on page 565
 - [":MEASure:IPOWer"](#) on page 568
 - [":MEASure:OPOWer"](#) on page 571

:POWer:ENABle

N (see [page 1384](#))

Command Syntax :POWer:ENABle {{0 | OFF} | {1 | ON}}

The :POWer:ENABle command enables or disables power analysis.

Query Syntax :POWer:ENABle?

The :POWer:ENABle query returns a 1 or a 0 showing whether power analysis is enabled or disabled, respectively.

Return Format {0 | 1}

See Also • [Chapter 23](#), “:MEASure Power Commands,” starting on page 557

:POWer:HARMonics:APPLy

N (see [page 1384](#))

Command Syntax

`:POWer:HARMonics:APPLy`

The `:POWer:HARMonics:APPLy` command applies the current harmonics analysis.

Switching power supplies draw a range of harmonics from the AC mains.

Standard limits are set for these harmonics because these harmonics can travel back to the supply grid and cause problems with other devices on the grid.

Use the Current Harmonics analysis to test a switching power supply's current harmonics to pre-compliance standard of IEC61000-3-2 (Class A, B, C, or D). The analysis presents up to 40 harmonics.

- See Also**
- [":POWer:HARMonics:DATA"](#) on page 645
 - [":POWer:HARMonics:DISPlay"](#) on page 646
 - [":POWer:HARMonics:FAILcount"](#) on page 647
 - [":POWer:HARMonics:LINE"](#) on page 648
 - [":POWer:HARMonics:POWerfactor"](#) on page 649
 - [":POWer:HARMonics:STANdard"](#) on page 653
 - [":POWer:HARMonics:STATus"](#) on page 654
 - [":POWer:HARMonics:RUNCount"](#) on page 652
 - [":POWer:HARMonics:THD"](#) on page 655

:POWer:HARMonics:DATA

N (see [page 1384](#))

Query Syntax :POWer:HARMonics:DATA?

The :POWer:HARMonics:DATA query returns the power harmonics results table data.

Return Format <binary_block> ::= comma-separated data with newlines at the end of each row

- See Also**
- [":POWer:HARMonics:APPLY"](#) on page 644
 - [":POWer:HARMonics:DISPlay"](#) on page 646
 - [":POWer:HARMonics:FAILcount"](#) on page 647
 - [":POWer:HARMonics:LINE"](#) on page 648
 - [":POWer:HARMonics:POWerfactor"](#) on page 649
 - [":POWer:HARMonics:RUNCount"](#) on page 652
 - [":POWer:HARMonics:STANdard"](#) on page 653
 - [":POWer:HARMonics:STATus"](#) on page 654
 - [":POWer:HARMonics:THD"](#) on page 655

:POWer:HARMonics:DISPlay

N (see [page 1384](#))

Command Syntax :POWer:HARMonics:DISPlay <display>
<display> ::= {TABLe | BAR | OFF}

The :POWer:HARMonics:DISPlay command specifies how to display the current harmonics analysis results:

- TABLE
- BAR – Bar chart.
- OFF – Harmonics measurement results are not displayed.

Query Syntax :POWer:HARMonics:DISPlay?

The :POWer:HARMonics:DISPlay query returns the display setting.

Return Format <display><NL>
<display> ::= {TABL | BAR | OFF}

- See Also**
- [":POWer:HARMonics:APPLy"](#) on page 644
 - [":POWer:HARMonics:DATA"](#) on page 645
 - [":POWer:HARMonics:FAILcount"](#) on page 647
 - [":POWer:HARMonics:LINE"](#) on page 648
 - [":POWer:HARMonics:POWerfactor"](#) on page 649
 - [":POWer:HARMonics:RUNCount"](#) on page 652
 - [":POWer:HARMonics:STANdard"](#) on page 653
 - [":POWer:HARMonics:STATus"](#) on page 654
 - [":POWer:HARMonics:THD"](#) on page 655

:POWer:HARMonics:FAILcount

N (see [page 1384](#))

Query Syntax :POWer:HARMonics:FAILcount?

Returns the current harmonics analysis' fail count. Non Spec values (that is, harmonics values not specified by the selected standard) are not counted.

Return Format <count><NL>

<count> ::= integer in NR1 format

- See Also**
- [":POWer:HARMonics:RUNCount"](#) on page 652
 - [":POWer:HARMonics:APPLY"](#) on page 644
 - [":POWer:HARMonics:DATA"](#) on page 645
 - [":POWer:HARMonics:DISPlay"](#) on page 646
 - [":POWer:HARMonics:LINE"](#) on page 648
 - [":POWer:HARMonics:POWerfactor"](#) on page 649
 - [":POWer:HARMonics:STANdard"](#) on page 653
 - [":POWer:HARMonics:STATus"](#) on page 654
 - [":POWer:HARMonics:THD"](#) on page 655

:POWer:HARMonics:LINE

N (see [page 1384](#))

Command Syntax `:POWer:HARMonics:LINE <frequency>`
 `<frequency> ::= {F50 | F60 | F400 | AUTO}`

The :POWer:HARMonics:LINE command specifies the line frequency setting for the current harmonics analysis:

- F50 – 50 Hz.
- F60 – 60 Hz.
- F400 – 400 Hz.
- AUTO – Automatically determines the frequency of the Current waveform.

Query Syntax `:POWer:HARMonics:LINE?`

The :POWer:HARMonics:LINE query returns the line frequency setting.

Return Format `<frequency><NL>`
 `<frequency> ::= {F50 | F60 | F400 | AUTO}`

- See Also**
- [":POWer:HARMonics:APPLy"](#) on page 644
 - [":POWer:HARMonics:DATA"](#) on page 645
 - [":POWer:HARMonics:DISPlay"](#) on page 646
 - [":POWer:HARMonics:FAILcount"](#) on page 647
 - [":POWer:HARMonics:POWerfactor"](#) on page 649
 - [":POWer:HARMonics:RUNCount"](#) on page 652
 - [":POWer:HARMonics:STANdard"](#) on page 653
 - [":POWer:HARMonics:STATus"](#) on page 654
 - [":POWer:HARMonics:THD"](#) on page 655

:POWer:HARMonics:POWerfactor

N (see [page 1384](#))

Query Syntax :POWer:HARMonics:POWerfactor?

The :POWer:HARMonics:POWerfactor query returns the power factor for IEC 61000-3-2 Standard Class C power factor value.

Return Format <value> ::= Class C power factor in NR3 format

- See Also**
- [":POWer:HARMonics:APPLY"](#) on page 644
 - [":POWer:HARMonics:DATA"](#) on page 645
 - [":POWer:HARMonics:DISPlay"](#) on page 646
 - [":POWer:HARMonics:FAILcount"](#) on page 647
 - [":POWer:HARMonics:LINE"](#) on page 648
 - [":POWer:HARMonics:RUNCount"](#) on page 652
 - [":POWer:HARMonics:STANdard"](#) on page 653
 - [":POWer:HARMonics:STATus"](#) on page 654
 - [":POWer:HARMonics:THD"](#) on page 655

:POWer:HARMonics:RPOWer

N (see [page 1384](#))

Command Syntax :POWer:HARMonics:RPOWer <source>
 <source> ::= {MEASured | USER}

When Class D is selected as the current harmonics analysis standard, the :POWer:HARMonics:RPOWer command specifies whether the Real Power value used for the current-per-watt measurement is measured by the oscilloscope or is defined by the user.

When USER is selected, use the :POWer:HARMonics:RPOWer:USER command to enter the user-defined value.

Query Syntax :POWer:HARMonics:RPOWer?

The :POWer:HARMonics:RPOWer? query returns the Real Power source setting.

Return Format <source><NL>
 <source> ::= {MEAS | USER}

- See Also**
- [":POWer:HARMonics:STANdard"](#) on page 653
 - [":POWer:HARMonics:RPOWer:USER"](#) on page 651

:POWer:HARMonics:RPOWer:USER

N (see [page 1384](#))

Command Syntax :POWer:HARMonics:RPOWer:USER <value>

<value> ::= Watts from 1.0 to 600.0 in NR3 format

When Class D is selected as the current harmonics analysis standard and you have chosen to use a user-defined Real Power value (see :POWer:HARMonics:RPOWer), the :POWer:HARMonics:RPOWer:USER command specifies the Real Power value used in the current-per-watt measurement.

Query Syntax :POWer:HARMonics:RPOWer:USER?

The :POWer:HARMonics:RPOWer:USER? query returns the user-defined Real Power value.

Return Format <value><NL>

<value> ::= Watts from 1.0 to 600.0 in NR3 format

- See Also**
- [":POWer:HARMonics:STANdard"](#) on page 653
 - [":POWer:HARMonics:RPOWer"](#) on page 650

:POWer:HARMonics:RUNCount

N (see [page 1384](#))

Query Syntax :POWer:HARMonics:RUNCount?

Returns the current harmonics analysis' run iteration count. Non Spec values (that is, harmonics values not specified by the selected standard) are not counted.

Return Format <count><NL>

<count> ::= integer in NR1 format

- See Also**
- [":POWer:HARMonics:FAILcount"](#) on page 647
 - [":POWer:HARMonics:APPLY"](#) on page 644
 - [":POWer:HARMonics:DATA"](#) on page 645
 - [":POWer:HARMonics:DISPlay"](#) on page 646
 - [":POWer:HARMonics:LINE"](#) on page 648
 - [":POWer:HARMonics:POWerfactor"](#) on page 649
 - [":POWer:HARMonics:STANdard"](#) on page 653
 - [":POWer:HARMonics:STATus"](#) on page 654
 - [":POWer:HARMonics:THD"](#) on page 655

:POWer:HARMonics:STANdard

N (see [page 1384](#))

Command Syntax :POWer:HARMonics:STANdard <class>

<class> ::= {A | B | C | D}

The :POWer:HARMonics:STANdard command selects the standard to perform current harmonics compliance testing on.

- A – IEC 61000-3-2 Class A – for balanced three-phase equipment, household appliances (except equipment identified as Class D), tools excluding portable tools, dimmers for incandescent lamps, and audio equipment.
- B – IEC 61000-3-2 Class B – for portable tools.
- C – IEC 61000-3-2 Class C – for lighting equipment.
- D – IEC 61000-3-2 Class D – for equipment having a specified power according less than or equal to 600 W, of the following types: personal computers and personal computer monitors, television receivers.

Query Syntax :POWer:HARMonics:STANdard?

The :POWer:HARMonics:STANdard query returns the currently set IEC 61000-3-2 standard.

Return Format <class><NL>

<class> ::= {A | B | C | D}

- See Also**
- [":POWer:HARMonics:APPLy"](#) on page 644
 - [":POWer:HARMonics:DATA"](#) on page 645
 - [":POWer:HARMonics:DISPlay"](#) on page 646
 - [":POWer:HARMonics:FAILcount"](#) on page 647
 - [":POWer:HARMonics:LINE"](#) on page 648
 - [":POWer:HARMonics:POWerfactor"](#) on page 649
 - [":POWer:HARMonics:RUNCount"](#) on page 652
 - [":POWer:HARMonics:STATus"](#) on page 654
 - [":POWer:HARMonics:THD"](#) on page 655

:POWer:HARMonics:STATus

N (see [page 1384](#))

Query Syntax :POWer:HARMonics:STATus?

The :POWer:HARMonics:STATus query returns the overall pass/fail status of the current harmonics analysis.

Return Format <status> ::= {PASS | FAIL | UNTested}

- See Also**
- [":POWer:HARMonics:RUNCount"](#) on page 652
 - [":POWer:HARMonics:FAILcount"](#) on page 647
 - [":POWer:HARMonics:APPLY"](#) on page 644
 - [":POWer:HARMonics:DATA"](#) on page 645
 - [":POWer:HARMonics:DISPlay"](#) on page 646
 - [":POWer:HARMonics:LINE"](#) on page 648
 - [":POWer:HARMonics:POWerfactor"](#) on page 649
 - [":POWer:HARMonics:STANdard"](#) on page 653
 - [":POWer:HARMonics:THD"](#) on page 655

:POWer:HARMonics:THD

N (see [page 1384](#))

Query Syntax :POWer:HARMonics:THD?

The :POWer:HARMonics:THD query returns the Total Harmonics Distortion (THD) results of the current harmonics analysis.

Return Format <value> ::= Total Harmonics Distortion in NR3 format

- See Also**
- [":POWer:HARMonics:APPLY"](#) on page 644
 - [":POWer:HARMonics:DATA"](#) on page 645
 - [":POWer:HARMonics:DISPlay"](#) on page 646
 - [":POWer:HARMonics:FAILcount"](#) on page 647
 - [":POWer:HARMonics:LINE"](#) on page 648
 - [":POWer:HARMonics:POWerfactor"](#) on page 649
 - [":POWer:HARMonics:RUNCount"](#) on page 652
 - [":POWer:HARMonics:STANdard"](#) on page 653
 - [":POWer:HARMonics:STATus"](#) on page 654

:POWer:INRush:APPLy

N (see [page 1384](#))

Command Syntax :POWer:INRush:APPLy

The :POWer:INRush:APPLy command applies the inrush current analysis.

The Inrush current analysis measures the peak inrush current of the power supply when the power supply is first turned on.

- See Also**
- [":POWer:ITYPE"](#) on page 659
 - [":POWer:INRush:EXIT"](#) on page 657
 - [":POWer:INRush:NEXT"](#) on page 658
 - [":MEASure:PCURrent"](#) on page 572

:POWer:INRush:EXIT

N (see [page 1384](#))

Command Syntax :POWer:INRush:EXIT

The :POWer:INRush:EXIT command exits (stops) the inrush current power analysis.

This command is equivalent to pressing the **Exit** softkey on the oscilloscope front panel during the analysis.

- See Also**
- [":POWer:INRush:APPLY"](#) on page 656
 - [":POWer:INRush:NEXT"](#) on page 658
 - [":POWer:ITYPE"](#) on page 659

:POWer:INRush:NEXT

N (see [page 1384](#))

Command Syntax :POWer:INRush:NEXT

The :POWer:INRush:NEXT command goes to the next step of the inrush current analysis.

This command is equivalent to pressing the **Next** softkey on the oscilloscope front panel when prompted during the analysis.

- See Also**
- [":POWer:INRush:APPLY"](#) on page 656
 - [":POWer:INRush:EXIT"](#) on page 657
 - [":POWer:ITYPE"](#) on page 659

:POWer:ITYPE

N (see [page 1384](#))

Command Syntax :POWer:ITYPE <type>

<type> ::= {DC | AC}

The :POWer:ITYPE command specifies the type of power that is being converted from the input (DC or AC). Your selection affects how the measurements are made.

This setting is used in the Inrush Current and Turn On/Turn Off tests.

Query Syntax :POWer:ITYPE?

The :POWer:ITYPE? query returns the input power type setting.

Return Format <type><NL>

<type> ::= {DC | AC}

- See Also**
- [":POWer:INRush:APPLY"](#) on page 656
 - [":POWer:ONOFF:APPLY"](#) on page 663

:POWer:MODulation:APPLY

N (see [page 1384](#))

Command Syntax :POWer:MODulation:APPLY

The :POWer:MODulation:APPLY command applies the selected modulation analysis type (:POWer:MODulation:TYPE).

The Modulation analysis measures the control pulse signal to a switching device (MOSFET) and observes the trending of the pulse width, duty cycle, period, frequency, etc. of the control pulse signal.

- See Also**
- [":POWer:MODulation:SOURce"](#) on page 661
 - [":POWer:MODulation:TYPE"](#) on page 662
 - [":MEASure:VAverage"](#) on page 544
 - [":MEASure:VRMS"](#) on page 550
 - [":MEASure:VRATio"](#) on page 549
 - [":MEASure:PERiod"](#) on page 520
 - [":MEASure:FREQuency"](#) on page 512
 - [":MEASure:PWIDth"](#) on page 524
 - [":MEASure:NWIDth"](#) on page 516
 - [":MEASure:DUTYcycle"](#) on page 510
 - [":MEASure:RISetime"](#) on page 528
 - [":MEASure:FALLtime"](#) on page 511

:POWer:MODulation:SOURce

N (see [page 1384](#))

Command Syntax :POWer:MODulation:SOURce <source>

<source> ::= {V | I}

The :POWer:MODulation:SOURce command selects either the voltage source or the current source as the source for the modulation analysis.

Query Syntax :POWer:MODulation:SOURce?

The :POWer:MODulation:SOURce query returns the selected source for the modulation analysis.

Return Format <source><NL>

<source> ::= {V | I}

- See Also**
- [":POWer:MODulation:APPLY"](#) on page 660
 - [":POWer:MODulation:TYPE"](#) on page 662

:POWer:MODulation:TYPE

N (see [page 1384](#))

Command Syntax :POWer:MODulation:TYPE <modulation>

```
<modulation> ::= {VAVerage | ACRMs | VRATio | PERiod | FREQuency
                  | PWIDith | NWIDth | DUTYcycle | RISetime | FALLtime}
```

The :POWer:MODulation:TYPE command selects the type of measurement to make in the modulation analysis:

- VAVerage
- ACRMs
- VRATio
- PERiod
- FREQuency
- PWIDth (positive pulse width)
- NWIDth (negative pulse width)
- DUTYcycle
- RISetime
- FALLtime

Query Syntax :POWer:MODulation:TYPE?

The :POWer:MODulation:TYPE query returns the modulation type setting.

Return Format <modulation><NL>

```
<modulation> ::= {VAV | ACRM | VRAT | PER | FREQ | PWID | NWID | DUTY
                  | RIS | FALL}
```

- See Also**
- [":POWer:MODulation:SOURce"](#) on page 661
 - [":POWer:MODulation:APPLY"](#) on page 660
 - [":MEASure:VAVerage"](#) on page 544
 - [":MEASure:VRMS"](#) on page 550
 - [":MEASure:VRATio"](#) on page 549
 - [":MEASure:PERiod"](#) on page 520
 - [":MEASure:FREQuency"](#) on page 512
 - [":MEASure:PWIDth"](#) on page 524
 - [":MEASure:NWIDth"](#) on page 516
 - [":MEASure:DUTYcycle"](#) on page 510
 - [":MEASure:RISetime"](#) on page 528
 - [":MEASure:FALLtime"](#) on page 511

:POWer:ONOFF:APPLy

N (see [page 1384](#))

Command Syntax :POWer:ONOFF:APPLy

The :POWer:ONOFF:APPLy command applies the selected turn on/off analysis test (:POWer:ONOFF:TEST).

- See Also**
- [":POWer:SIGNals:VSTeady:ONOFF:OFF"](#) on page 697
 - [":POWer:SIGNals:VSTeady:ONOFF:ON"](#) on page 698
 - [":POWer:ITYPE"](#) on page 659
 - [":POWer:ONOFF:THResholds"](#) on page 667
 - [":POWer:ONOFF:TEST"](#) on page 666
 - [":POWer:ONOFF:EXIT"](#) on page 664
 - [":POWer:ONOFF:NEXT"](#) on page 665
 - [":MEASure:ONTime"](#) on page 570
 - [":MEASure:OFFTime"](#) on page 569

:POWer:ONOFF:EXIT

N (see [page 1384](#))

Command Syntax :POWer:ONOFF:EXIT

The :POWer:ONOFF:EXIT command exits (stops) the turn on time/turn off time analysis.

This command is equivalent to pressing the **Exit** softkey on the oscilloscope front panel during the analysis.

- See Also**
- [":POWer:ONOFF:THResholds"](#) on page 667
 - [":POWer:ITYPE"](#) on page 659
 - [":POWer:ONOFF:APPLY"](#) on page 663
 - [":POWer:ONOFF:NEXT"](#) on page 665
 - [":POWer:ONOFF:TEST"](#) on page 666

:POWer:ONOFF:NEXT

N (see [page 1384](#))

Command Syntax :POWer:ONOFF:NEXT

The :POWer:ONOFF:NEXT command goes to the next step of the turn on/turn off analysis.

This command is equivalent to pressing the **Next** softkey on the oscilloscope front panel when prompted during the analysis.

- See Also**
- [":POWer:ONOFF:THResholds"](#) on page 667
 - [":POWer:ITYPE"](#) on page 659
 - [":POWer:ONOFF:APPLY"](#) on page 663
 - [":POWer:ONOFF:EXIT"](#) on page 664
 - [":POWer:ONOFF:TEST"](#) on page 666

:POWer:ONOFF:TEST

N (see [page 1384](#))

Command Syntax :POWer:ONOFF:TEST {{0 | OFF} | {1 | ON}}

The :POWer:ONOFF:TEST command selects whether turn on or turn off analysis is performed:

- ON – Turn On – measures the time taken to get the output voltage of the power supply after the input voltage is applied.
- OFF – Turn Off – measures the time taken for the output voltage of the power supply to turn off after the input voltage is removed.

Query Syntax :POWer:ONOFF:TEST?

The :POWer:ONOFF:TEST query returns the selected test type.

Return Format {0 | 1}

- See Also**
- [":POWer:ONOFF:THResholds"](#) on page 667
 - [":POWer:ITYPE"](#) on page 659
 - [":POWer:ONOFF:APPLY"](#) on page 663
 - [":POWer:ONOFF:EXIT"](#) on page 664
 - [":POWer:ONOFF:NEXT"](#) on page 665

:POWer:ONOFF:THResholds

N (see [page 1384](#))

Command Syntax :POWer:ONOFF:THResholds <type>,<input_thr>,<output_thr>

<type> ::= {ON | OFF}

<input_thr> ::= percent from 0-100 in NR1 format

<output_thr> ::= percent from 0-100 in NR1 format

The :POWer:ONOFF:THResholds command specifies the input and output thresholds used in the Turn On/Turn Off analysis.

Turn On analysis determines how fast a turned on power supply takes to reach some percent of its steady state output. Turn on time is the time between T2 and T1 where:

- T1 = when the input voltage first rises to some percent (typically the 10% threshold) of its maximum amplitude.
- T2 = when the output DC voltage rises to some percent (typically the 90% threshold) of its maximum amplitude.

Turn Off analysis determines how fast a turned off power supply takes to reduce its output voltage to some percent of maximum. Turn off time is the time between T2 and T1 where:

- T1 = when the input voltage last falls to some percent (typically the 10% threshold) of its maximum amplitude.
- T2 = when the output DC voltage last falls to some percent (typically the 10% threshold) of its maximum amplitude.

Query Syntax :POWer:ONOFF:THResholds? <type>

The :POWer:ONOFF:THResholds? query returns the input and output threshold settings for the turn on/turn off analysis type.

Return Format <input_thr>,<output_thr><NL>

<input_thr> ::= percent from 0-100 in NR1 format

<output_thr> ::= percent from 0-100 in NR1 format

- See Also**
- **":POWer:SIGNals:VSTeady:ONOFF:OFF"** on page 697
 - **":POWer:SIGNals:VSTeady:ONOFF:ON"** on page 698
 - **":POWer:ITYPE"** on page 659
 - **":POWer:ONOFF:APPLY"** on page 663
 - **":POWer:ONOFF:TEST"** on page 666
 - **":POWer:ONOFF:EXIT"** on page 664
 - **":POWer:ONOFF:NEXT"** on page 665
 - **":MEASure:ONTime"** on page 570

- **":MEASure:OFFTime"** on page 569

:POWer:PSRR

N (see [page 1384](#))

Query Syntax :POWer:PSRR?

The :POWer:PSRR? query returns the Power Supply Rejection Ratio (PSRR) power analysis settings.

Return Format <settings_string><NL>

For example, the query returns the following string when issued after the *RST command.

```
:POW:PSRR:SOUR:INP CHAN1;OUTP CHAN2;:POW:PSRR:FREQ:STAR +100E+00;
STOP +20.000000E+06;:POW:PSRR:WGEN:VOLT +200.0E-03;LOAD FIFT
```

- See Also**
- [":POWer:PSRR:APPLy"](#) on page 670
 - [":POWer:PSRR:DATA"](#) on page 671
 - [":POWer:PSRR:FREQuency:MAXimum"](#) on page 672
 - [":POWer:PSRR:FREQuency:MINimum"](#) on page 673
 - [":POWer:PSRR:FREQuency:MODE"](#) on page 674
 - [":POWer:PSRR:PPDecade"](#) on page 675
 - [":POWer:PSRR:SOURce:INPut"](#) on page 676
 - [":POWer:PSRR:SOURce:OUTPut"](#) on page 677
 - [":POWer:PSRR:WGEN:LOAD"](#) on page 678
 - [":POWer:PSRR:WGEN:VOLTage"](#) on page 679
 - [":POWer:PSRR:WGEN:VOLTage:PROFile"](#) on page 680

`:POWer:PSRR:APPLy`

N (see [page 1384](#))

Command Syntax `:POWer:PSRR:APPLy`

The `:POWer:PSRR:APPLy` command applies the power supply rejection ratio (PSRR) analysis.

The Power Supply Rejection Ratio (PSRR) test is used to determine how well a voltage regulator rejects ripple noise over different frequency range.

This analysis provides a signal from the oscilloscope's waveform generator that sweeps its frequency. This signal is used to inject ripple to the DC voltage that feeds the voltage regulator.

The AC RMS ratio of the input over the output is measured and is plotted over the range of frequencies.

It takes some time for the frequency sweep analysis to complete. You can query bit 0 of the Standard Event Status Register (`*ESR?`) to find out when the analysis is complete.

- See Also**
- ["*ESR \(Standard Event Status Register\)"](#) on page 194
 - [":POWer:PSRR"](#) on page 669
 - [":POWer:PSRR:DATA"](#) on page 671
 - [":POWer:PSRR:FREQuency:MAXimum"](#) on page 672
 - [":POWer:PSRR:FREQuency:MINimum"](#) on page 673
 - [":POWer:PSRR:FREQuency:MODE"](#) on page 674
 - [":POWer:PSRR:PPDecade"](#) on page 675
 - [":POWer:PSRR:SOURce:INPut"](#) on page 676
 - [":POWer:PSRR:SOURce:OUTPut"](#) on page 677
 - [":POWer:PSRR:WGEN:LOAD"](#) on page 678
 - [":POWer:PSRR:WGEN:VOLTage"](#) on page 679
 - [":POWer:PSRR:WGEN:VOLTage:PROFile"](#) on page 680

:POWer:PSRR:DATA

N (see [page 1384](#))

Query Syntax :POWer:PSRR:DATA?

The :POWer:PSRR:DATA? query returns data from the Power Supply Rejection Ratio (PSRR) power analysis.

The comma-separated value format is suitable for spreadsheet analysis.

Return Format <binary_block><NL>

<binary_block> ::= comma-separated data with newlines at the end of each row

- See Also**
- [":POWer:PSRR"](#) on page 669
 - [":POWer:PSRR:APPLy"](#) on page 670
 - [":POWer:PSRR:FREQuency:MAXimum"](#) on page 672
 - [":POWer:PSRR:FREQuency:MINimum"](#) on page 673
 - [":POWer:PSRR:FREQuency:MODE"](#) on page 674
 - [":POWer:PSRR:PPDecade"](#) on page 675
 - [":POWer:PSRR:SOURce:INPut"](#) on page 676
 - [":POWer:PSRR:SOURce:OUTPut"](#) on page 677
 - [":POWer:PSRR:WGEN:LOAD"](#) on page 678
 - [":POWer:PSRR:WGEN:VOLTage"](#) on page 679
 - [":POWer:PSRR:WGEN:VOLTage:PROFile"](#) on page 680

:POWer:PSRR:FREQuency:MAXimum

N (see [page 1384](#))

Command Syntax :POWer:PSRR:FREQuency:MAXimum <value>[suffix]

<value> ::= {10 | 100 | 1000 | 10000 | 100000 | 1000000 | 10000000
| 20000000}

[suffix] ::= {Hz | kHz | MHz}

The :POWer:PSRR:FREQuency:MAXimum command sets the end sweep frequency value. The PSRR measurement is displayed on a log scale, so you can select from decade values in addition to the maximum frequency of 20 MHz.

Query Syntax :POWer:PSRR:FREQuency:MAXimum?

The :POWer:PSRR:FREQuency:MAXimum query returns the maximum sweep frequency setting.

Return Format <value><NL>

<value> ::= {10 | 100 | 1000 | 10000 | 100000 | 1000000 | 10000000
| 20000000}

- See Also**
- [":POWer:PSRR"](#) on page 669
 - [":POWer:PSRR:APPLy"](#) on page 670
 - [":POWer:PSRR:DATA"](#) on page 671
 - [":POWer:PSRR:FREQuency:MINimum"](#) on page 673
 - [":POWer:PSRR:FREQuency:MODE"](#) on page 674
 - [":POWer:PSRR:PPDecade"](#) on page 675
 - [":POWer:PSRR:SOURce:INPut"](#) on page 676
 - [":POWer:PSRR:SOURce:OUTPut"](#) on page 677
 - [":POWer:PSRR:WGEN:LOAD"](#) on page 678
 - [":POWer:PSRR:WGEN:VOLTage"](#) on page 679
 - [":POWer:PSRR:WGEN:VOLTage:PROFile"](#) on page 680

:POWer:PSRR:FREQuency:MINimum

N (see [page 1384](#))

Command Syntax :POWer:PSRR:FREQuency:MINimum <value>[suffix]
 <value> ::= {1 | 10 | 100 | 1000 | 10000 | 100000 | 1000000 | 10000000}
 [suffix] ::= {Hz | kHz | MHz}

The :POWer:PSRR:FREQuency:MINimum command sets the start sweep frequency value. The measurement is displayed on a log scale, so you can select from decade values.

Query Syntax :POWer:PSRR:FREQuency:MINimum?

The :POWer:PSRR:FREQuency:MINimum query returns the minimum sweep frequency setting.

Return Format <value><NL>
 <value> ::= {1 | 10 | 100 | 1000 | 10000 | 100000 | 1000000 | 10000000}

- See Also**
- [":POWer:PSRR"](#) on page 669
 - [":POWer:PSRR:APPLy"](#) on page 670
 - [":POWer:PSRR:DATA"](#) on page 671
 - [":POWer:PSRR:FREQuency:MAXimum"](#) on page 672
 - [":POWer:PSRR:FREQuency:MODE"](#) on page 674
 - [":POWer:PSRR:PPDecade"](#) on page 675
 - [":POWer:PSRR:SOURce:INPut"](#) on page 676
 - [":POWer:PSRR:SOURce:OUTPut"](#) on page 677
 - [":POWer:PSRR:WGEN:LOAD"](#) on page 678
 - [":POWer:PSRR:WGEN:VOLTage"](#) on page 679
 - [":POWer:PSRR:WGEN:VOLTage:PROFile"](#) on page 680

:POWer:PSRR:FREQuency:MODE

N (see [page 1384](#))

Command Syntax :POWer:PSRR:FREQuency:MODE <mode>

<mode> ::= {SWEep | SINGle}

The :POWer:PSRR:FREQuency:MODE command specifies whether the analysis should be performed by sweeping through a range of frequencies (SWEep) or at a single frequency (SINGle).

The SINGle mode is useful for evaluating amplitudes at a single frequency. After running the test at a single frequency, you can manually adjust (increase) the waveform generator's amplitude until you begin to observe distortion in the waveforms on the oscilloscope's display. You can then use that amplitude at all frequencies in SWEep mode, or you can evaluate amplitudes at other frequencies in order to determine an optimized amplitude profile (see :POWer:PSRR:WGEN:VOLTage:PROFile).

Query Syntax :POWer:CLResponse:FREQuency:MODE?

The :POWer:PSRR:FREQuency:MODE? query returns the frequency mode setting.

Return Format <mode><NL>

<mode> ::= {SWE | SING}

- See Also**
- [":POWer:PSRR"](#) on page 669
 - [":POWer:PSRR:APPLy"](#) on page 670
 - [":POWer:PSRR:DATA"](#) on page 671
 - [":POWer:PSRR:FREQuency:MAXimum"](#) on page 672
 - [":POWer:PSRR:FREQuency:MINimum"](#) on page 673
 - [":POWer:PSRR:PPDecade"](#) on page 675
 - [":POWer:PSRR:SOURce:INPut"](#) on page 676
 - [":POWer:PSRR:SOURce:OUTPut"](#) on page 677
 - [":POWer:PSRR:WGEN:LOAD"](#) on page 678
 - [":POWer:PSRR:WGEN:VOLTage"](#) on page 679
 - [":POWer:PSRR:WGEN:VOLTage:PROFile"](#) on page 680

:POWer:PSRR:PPDecade

N (see [page 1384](#))

Command Syntax :POWer:PSRR:PPDecade <pts>

<pts> ::= {10 | 20 | 30 | 40 | 50}

The :POWer:PSRR:PPDecade command selects the number of frequency test points per decade (in the log scale).

Query Syntax :POWer:CLResponse:PPDecade?

The :POWer:PSRR:PPDecade? query returns the points per decade setting.

Return Format <pts><NL>

<pts> ::= {10 | 20 | 30 | 40 | 50}

- See Also**
- [":POWer:PSRR"](#) on page 669
 - [":POWer:PSRR:APPLy"](#) on page 670
 - [":POWer:PSRR:DATA"](#) on page 671
 - [":POWer:PSRR:FREQuency:MAXimum"](#) on page 672
 - [":POWer:PSRR:FREQuency:MINimum"](#) on page 673
 - [":POWer:PSRR:FREQuency:MODE"](#) on page 674
 - [":POWer:PSRR:SOURce:INPut"](#) on page 676
 - [":POWer:PSRR:SOURce:OUTPut"](#) on page 677
 - [":POWer:PSRR:WGEN:LOAD"](#) on page 678
 - [":POWer:PSRR:WGEN:VOLTage"](#) on page 679
 - [":POWer:PSRR:WGEN:VOLTage:PROFile"](#) on page 680

:POWer:PSRR:SOURce:INPut

N (see [page 1384](#))

Command Syntax :POWer:PSRR:SOURce:INPut <source>

<source> ::= CHANnel<n>

<n> ::= 1 to (# analog channels) in NR1 format

The :POWer:PSRR:SOURce:INPut command selects the oscilloscope channel that is probing the power supply input.

Query Syntax :POWer:PSRR:SOURce:INPut?

The :POWer:PSRR:SOURce:INPut? query returns the channel selection.

Return Format <source><NL>

<source> ::= CHAN<n>

- See Also**
- [":POWer:PSRR"](#) on page 669
 - [":POWer:PSRR:APPLy"](#) on page 670
 - [":POWer:PSRR:DATA"](#) on page 671
 - [":POWer:PSRR:FREQuency:MAXimum"](#) on page 672
 - [":POWer:PSRR:FREQuency:MINimum"](#) on page 673
 - [":POWer:PSRR:FREQuency:MODE"](#) on page 674
 - [":POWer:PSRR:PPDecade"](#) on page 675
 - [":POWer:PSRR:SOURce:OUTPut"](#) on page 677
 - [":POWer:PSRR:WGEN:LOAD"](#) on page 678
 - [":POWer:PSRR:WGEN:VOLTage"](#) on page 679
 - [":POWer:PSRR:WGEN:VOLTage:PROFile"](#) on page 680

:POWer:PSRR:SOURce:OUTPut

N (see [page 1384](#))

Command Syntax :POWer:PSRR:SOURce:OUTPut <source>

<source> ::= CHANnel<n>

<n> ::= 1 to (# analog channels) in NR1 format

The :POWer:PSRR:SOURce:OUTPut command selects the oscilloscope channel that is probing the power supply output.

Query Syntax :POWer:PSRR:SOURce:OUTPut?

The :POWer:PSRR:SOURce:OUTPut? query returns the channel selection.

Return Format <source><NL>

<source> ::= CHAN<n>

- See Also**
- [":POWer:PSRR"](#) on page 669
 - [":POWer:PSRR:APPLy"](#) on page 670
 - [":POWer:PSRR:DATA"](#) on page 671
 - [":POWer:PSRR:FREQuency:MAXimum"](#) on page 672
 - [":POWer:PSRR:FREQuency:MINimum"](#) on page 673
 - [":POWer:PSRR:FREQuency:MODE"](#) on page 674
 - [":POWer:PSRR:PPDecade"](#) on page 675
 - [":POWer:PSRR:SOURce:INPut"](#) on page 676
 - [":POWer:PSRR:WGEN:LOAD"](#) on page 678
 - [":POWer:PSRR:WGEN:VOLTage"](#) on page 679
 - [":POWer:PSRR:WGEN:VOLTage:PROFile"](#) on page 680

:POWer:PSRR:WGEN:LOAD

N (see [page 1384](#))

Command Syntax :POWer:PSRR:WGEN:LOAD <impedance>
 <impedance> ::= {ONEMeg | FIFTy}

The :POWer:PSRR:WGEN:LOAD command sets the waveform generator expected output load impedance.

The output impedance of the Gen Out signal is fixed at 50 ohms. However, the output load selection lets the waveform generator display the correct amplitude and offset levels for the expected output load. If the actual load impedance is different than the selected value, the displayed amplitude and offset levels will be incorrect.

Query Syntax :POWer:PSRR:WGEN:LOAD?

The :POWer:PSRR:WGEN:LOAD? query returns the waveform generator expected output load impedance setting.

Return Format <impedance><NL>
 <impedance> ::= {ONEM | FIFT}

- See Also**
- [":POWer:PSRR"](#) on page 669
 - [":POWer:PSRR:APPLy"](#) on page 670
 - [":POWer:PSRR:DATA"](#) on page 671
 - [":POWer:PSRR:FREQuency:MAXimum"](#) on page 672
 - [":POWer:PSRR:FREQuency:MINimum"](#) on page 673
 - [":POWer:PSRR:FREQuency:MODE"](#) on page 674
 - [":POWer:PSRR:PPDecade"](#) on page 675
 - [":POWer:PSRR:SOURce:INPut"](#) on page 676
 - [":POWer:PSRR:SOURce:OUTPut"](#) on page 677
 - [":POWer:PSRR:WGEN:VOLTage"](#) on page 679
 - [":POWer:PSRR:WGEN:VOLTage:PROFile"](#) on page 680

:POWer:PSRR:WGEN:VOLTage

N (see [page 1384](#))

Command Syntax :POWer:PSRR:WGEN:VOLTage <amplitude>[,<range>]

<amplitude> ::= amplitude in volts in NR3 format

<range> ::= {F20HZ | F100HZ | F1KHZ | F10KHZ | F100KHZ | F1MHZ
| F10MHZ | F20MHZ}

The :POWer:PSRR:WGEN:VOLTage command sets the waveform generator output amplitude(s).

When the waveform generator amplitude profile is enabled (with the :POWer:PSRR:WGEN:VOLTage:PROFile command), you can set an initial ramp amplitude for each frequency range.

Without the <range> parameter, this command sets the waveform generator output amplitude used when the amplitude profile is disabled.

Query Syntax :POWer:PSRR:WGEN:VOLTage? [<range>]

The :POWer:PSRR:WGEN:VOLTage? query returns the waveform generator output amplitude setting(s).

Return Format <amplitude><NL>

<amplitude> ::= amplitude in volts in NR3 format

- See Also**
- [":POWer:PSRR"](#) on page 669
 - [":POWer:PSRR:APPLy"](#) on page 670
 - [":POWer:PSRR:DATA"](#) on page 671
 - [":POWer:PSRR:FREQuency:MAXimum"](#) on page 672
 - [":POWer:PSRR:FREQuency:MINimum"](#) on page 673
 - [":POWer:PSRR:FREQuency:MODE"](#) on page 674
 - [":POWer:PSRR:PPDecade"](#) on page 675
 - [":POWer:PSRR:SOURce:INPut"](#) on page 676
 - [":POWer:PSRR:SOURce:OUTPut"](#) on page 677
 - [":POWer:PSRR:WGEN:LOAD"](#) on page 678
 - [":POWer:PSRR:WGEN:VOLTage:PROFile"](#) on page 680

:POWer:PSRR:WGEN:VOLTage:PROFile

N (see [page 1384](#))

Command Syntax :POWer:PSRR:WGEN:VOLTage:PROFile {{0 | OFF} | {1 | ON}}

The :POWer:PSRR:WGEN:VOLTage:PROFile command enables or disables the ability to set initial waveform generator ramp amplitudes for each frequency range.

With amplitude profiling, you can use lower amplitudes at frequencies where the device under test (DUT) is sensitive to distortion and use higher amplitudes where the DUT is less sensitive to distortion.

You can often observe distortions during the test. If the input test sine wave begins to look lopsided, clipped, or somewhat triangular in shape (nonsinusoidal), you are probably encountering distortion due to overdriving your DUT. Optimizing test amplitudes to achieve the best dynamic range measurements is often an iterative process of running your frequency response measurements multiple times.

Query Syntax :POWer:CLResponse:WGEN:VOLTage:PROFile?

The :POWer:PSRR:WGEN:VOLTage:PROFile? query returns the voltage profile setting.

Return Format <setting><NL>

<setting> ::= {0 | 1}

- See Also**
- **":POWer:PSRR"** on page 669
 - **":POWer:PSRR:APPLy"** on page 670
 - **":POWer:PSRR:DATA"** on page 671
 - **":POWer:PSRR:FREQuency:MAXimum"** on page 672
 - **":POWer:PSRR:FREQuency:MINimum"** on page 673
 - **":POWer:PSRR:FREQuency:MODE"** on page 674
 - **":POWer:PSRR:PPDecade"** on page 675
 - **":POWer:PSRR:SOURce:INPut"** on page 676
 - **":POWer:PSRR:SOURce:OUTPut"** on page 677
 - **":POWer:PSRR:WGEN:LOAD"** on page 678
 - **":POWer:PSRR:WGEN:VOLTage"** on page 679

:POWer:QUALity:APPLy

N (see [page 1384](#))

Command Syntax :POWer:QUALity:APPLy

The :POWer:QUALity:APPLy command applies the selected power quality analysis type (:POWer:QUALity:TYPE).

The power quality analysis shows the quality of the AC input line.

Some AC current may flow back into and back out of the load without delivering energy. This current, called reactive or harmonic current, gives rise to an "apparent" power which is larger than the actual power consumed. Power quality is gauged by these measurements: power factor, apparent power, true power, reactive power, crest factor, and phase angle of the current and voltage of the AC line.

- See Also**
- [":MEASure:FACTor"](#) on page 567
 - [":MEASure:REAL"](#) on page 576
 - [":MEASure:APParent"](#) on page 562
 - [":MEASure:REACTive"](#) on page 575
 - [":MEASure:CRESt"](#) on page 564
 - [":MEASure:ANGLE"](#) on page 561

:POWer:RIPPlE:APPLy

N (see [page 1384](#))

Command Syntax :POWer:RIPPlE:APPLy

The :POWer:RIPPlE:APPLy command applies the output ripple analysis.

See Also • [":MEASure:RIPPlE"](#) on page 577

:POWer:SIGNals:AUTosetup

N (see [page 1384](#))

Command Syntax :POWer:SIGNals:AUTosetup <analysis>
 <analysis> ::= {HARMonics | EFFiciency | RIPple | MODulation | QUALity
 | SLEW | SWITCh | RDSVce}

The :POWer:SIGNals:AUTosetup command performs automated oscilloscope setup for the signals in the specified type of power analysis.

- See Also**
- [":POWer:HARMonics:DISPlay"](#) on page 646
 - [":POWer:EFFiciency:APPLY"](#) on page 641
 - [":POWer:RIPple:APPLY"](#) on page 682
 - [":POWer:MODulation:APPLY"](#) on page 660
 - [":POWer:QUALity:APPLY"](#) on page 681
 - [":POWer:SLEW:APPLY"](#) on page 702
 - [":POWer:SWITCh:APPLY"](#) on page 704
 - [":POWer:SIGNals:CYCLes:HARMonics"](#) on page 684
 - [":POWer:SIGNals:CYCLes:QUALity"](#) on page 685
 - [":POWer:SIGNals:DURation:EFFiciency"](#) on page 686
 - [":POWer:SIGNals:DURation:MODulation"](#) on page 687
 - [":POWer:SIGNals:DURation:RIPple"](#) on page 690
 - [":POWer:SIGNals:IEXpected"](#) on page 692
 - [":POWer:SIGNals:OVERshoot"](#) on page 693
 - [":POWer:SIGNals:SOURce:CURRent<i>"](#) on page 700
 - [":POWer:SIGNals:SOURce:VOLTage<i>"](#) on page 701

:POWer:SIGNals:CYCLes:HARMonics

N (see [page 1384](#))

Command Syntax :POWer:SIGNals:CYCLes:HARMonics <count>
 <count> ::= integer in NR1 format
 Legal values are 1 to 100.

The :POWer:SIGNals:CYCLes:HARMonics command specifies the number of cycles to include in the current harmonics analysis.

Query Syntax :POWer:SIGNals:CYCLes:HARMonics?

The :POWer:SIGNals:CYCLes:HARMonics query returns the number of cycles currently set.

Return Format <count><NL>
 <count> ::= integer in NR1 format

- See Also**
- [":POWer:HARMonics:DISPlay"](#) on page 646
 - [":POWer:HARMonics:APPLy"](#) on page 644
 - [":POWer:SIGNals:AUTosetup"](#) on page 683
 - [":POWer:SIGNals:IEXPeCted"](#) on page 692
 - [":POWer:SIGNals:OVERshoot"](#) on page 693
 - [":POWer:SIGNals:SOURce:CURRent<i>"](#) on page 700
 - [":POWer:SIGNals:SOURce:VOLTage<i>"](#) on page 701

:POWER:SIGNals:CYCLes:QUALity

N (see [page 1384](#))

Command Syntax :POWER:SIGNals:CYCLes:QUALity <count>

<count> ::= integer in NR1 format

Legal values are 1 to 100.

The :POWER:SIGNals:CYCLes:QUALity command specifies the number of cycles to include in the power quality analysis.

Query Syntax :POWER:SIGNals:CYCLes:QUALity?

The :POWER:SIGNals:CYCLes:QUALity query returns the number of cycles currently set.

Return Format <count><NL>

<count> ::= integer in NR1 format

- See Also**
- [":POWER:QUALity:APPLy"](#) on page 681
 - [":POWER:SIGNals:AUTOsetup"](#) on page 683
 - [":POWER:SIGNals:IEXpected"](#) on page 692
 - [":POWER:SIGNals:OVERshoot"](#) on page 693
 - [":POWER:SIGNals:SOURce:CURRent<i>"](#) on page 700
 - [":POWER:SIGNals:SOURce:VOLTage<i>"](#) on page 701

:POWer:SIGNals:DURation:EFFiciency

N (see [page 1384](#))

Command Syntax :POWer:SIGNals:DURation:EFFiciency <value>[suffix]

<value> ::= value in NR3 format

[suffix] ::= {s | ms | us | ns}

The :POWer:SIGNals:DURation:EFFiciency command specifies the duration of the efficiency analysis.

Query Syntax :POWer:SIGNals:DURation:EFFiciency?

The :POWer:SIGNals:DURation:EFFiciency query returns the set duration time value.

Return Format <value><NL>

<value> ::= value in NR3 format

- See Also**
- [":POWer:EFFiciency:APPLY"](#) on page 641
 - [":POWer:SIGNals:AUTOsetup"](#) on page 683
 - [":POWer:SIGNals:IEXpected"](#) on page 692
 - [":POWer:SIGNals:OVERshoot"](#) on page 693
 - [":POWer:SIGNals:SOURce:CURRent<i>"](#) on page 700
 - [":POWer:SIGNals:SOURce:VOLTage<i>"](#) on page 701

:POWer:SIGNals:DURation:MODulation

N (see [page 1384](#))

Command Syntax :POWer:SIGNals:DURation:MODulation <value>[suffix]

<value> ::= value in NR3 format

[suffix] ::= {s | ms | us | ns}

The :POWer:SIGNals:DURation:MODulation command specifies the duration of the modulation analysis.

Query Syntax :POWer:SIGNals:DURation:MODulation?

The :POWer:SIGNals:DURation:MODulation query returns the set duration time value.

Return Format <value><NL>

<value> ::= value in NR3 format

- See Also**
- [":POWer:MODulation:APPLY"](#) on page 660
 - [":POWer:SIGNals:AUTOsetup"](#) on page 683
 - [":POWer:SIGNals:IEXpected"](#) on page 692
 - [":POWer:SIGNals:OVERshoot"](#) on page 693
 - [":POWer:SIGNals:SOURce:CURREnt<i>"](#) on page 700
 - [":POWer:SIGNals:SOURce:VOLTage<i>"](#) on page 701

:POWer:SIGNals:DURation:ONOFF:OFF

N (see [page 1384](#))

Command Syntax :POWer:SIGNals:DURation:ONOFF:OFF <value>[suffix]

<value> ::= value in NR3 format

[suffix] ::= {s | ms | us | ns}

The :POWer:SIGNals:DURation:ONOFF:OFF command specifies the duration of the turn off analysis.

Query Syntax :POWer:SIGNals:DURation:ONOFF:OFF?

The :POWer:SIGNals:DURation:ONOFF:OFF query returns the set duration time value.

Return Format <value><NL>

<value> ::= value in NR3 format

- See Also**
- [":POWer:ONOFF:APPLY"](#) on page 663
 - [":POWer:SIGNals:AUTOsetup"](#) on page 683
 - [":POWer:SIGNals:IEXpected"](#) on page 692
 - [":POWer:SIGNals:OVERshoot"](#) on page 693
 - [":POWer:SIGNals:VMAXimum:ONOFF:OFF"](#) on page 695
 - [":POWer:SIGNals:VSTeady:ONOFF:OFF"](#) on page 697
 - [":POWer:SIGNals:SOURce:CURREnt<i>"](#) on page 700
 - [":POWer:SIGNals:SOURce:VOLTage<i>"](#) on page 701

:POWer:SIGNals:DURation:ONOff:ON

N (see [page 1384](#))

Command Syntax :POWer:SIGNals:DURation:ONOff:ON <value> [suffix]

<value> ::= value in NR3 format

[suffix] ::= {s | ms | us | ns}

The :POWer:SIGNals:DURation:ONOff:ON command specifies the duration of the turn on analysis.

Query Syntax :POWer:SIGNals:DURation:ONOff:ON?

The :POWer:SIGNals:DURation:ONOff:ON query returns the set duration time value.

Return Format <value><NL>

<value> ::= value in NR3 format

- See Also**
- [":POWer:ONOff:APPLy"](#) on page 663
 - [":POWer:SIGNals:AUTOsetup"](#) on page 683
 - [":POWer:SIGNals:IEXpected"](#) on page 692
 - [":POWer:SIGNals:OVERshoot"](#) on page 693
 - [":POWer:SIGNals:VMAXimum:ONOff:ON"](#) on page 696
 - [":POWer:SIGNals:VSTeady:ONOff:ON"](#) on page 698
 - [":POWer:SIGNals:SOURce:CURREnt<i>"](#) on page 700
 - [":POWer:SIGNals:SOURce:VOLTage<i>"](#) on page 701

:POWer:SIGNals:DURation:RIPPlE

N (see [page 1384](#))

Command Syntax :POWer:SIGNals:DURation:RIPPlE <value>[suffix]

<value> ::= value in NR3 format

[suffix] ::= {s | ms | us | ns}

The :POWer:SIGNals:DURation:RIPPlE command specifies the duration of the output ripple analysis.

Query Syntax :POWer:SIGNals:DURation:RIPPlE?

The :POWer:SIGNals:DURation:RIPPlE query returns the set duration time value.

Return Format <value><NL>

<value> ::= value in NR3 format

- See Also**
- [":POWer:RIPPlE:APPLy"](#) on page 682
 - [":POWer:SIGNals:AUTOsetuP"](#) on page 683
 - [":POWer:SIGNals:IEXPeCted"](#) on page 692
 - [":POWer:SIGNals:OVERshooT"](#) on page 693
 - [":POWer:SIGNals:SOURce:CURREnt<i>"](#) on page 700
 - [":POWer:SIGNals:SOURce:VOLTage<i>"](#) on page 701

:POWer:SIGNals:DURation:TRANsient

N (see [page 1384](#))

Command Syntax :POWer:SIGNals:DURation:TRANsient <value>[suffix]

<value> ::= value in NR3 format

[suffix] ::= {s | ms | us | ns}

The :POWer:SIGNals:DURation:TRANsient command specifies the duration of the transient response analysis.

Query Syntax :POWer:SIGNals:DURation:TRANsient?

The :POWer:SIGNals:DURation:TRANsient query returns the set duration time value.

Return Format <value><NL>

<value> ::= value in NR3 format

- See Also**
- [":POWer:TRANsient:APPLY"](#) on page 710
 - [":POWer:SIGNals:AUTOsetup"](#) on page 683
 - [":POWer:SIGNals:IEXpected"](#) on page 692
 - [":POWer:SIGNals:OVERshoot"](#) on page 693
 - [":POWer:SIGNals:VSTeady:TRANsient"](#) on page 699
 - [":POWer:SIGNals:SOURce:CURRENT<i>"](#) on page 700
 - [":POWer:SIGNals:SOURce:VOLTage<i>"](#) on page 701

:POWer:SIGNals:IEXPected

N (see [page 1384](#))

Command Syntax `:POWer:SIGNals:IEXPected <value>[suffix]`
 `<value> ::= Expected current value in NR3 format`
 `[suffix] ::= {A | mA}`

The `:POWer:SIGNals:IEXPected` command specifies the expected inrush current amplitude. This value is used to set the vertical scale of the channel probing current.

Query Syntax `:POWer:SIGNals:IEXPected?`

The `:POWer:SIGNals:IEXPected` query returns the expected inrush current setting.

Return Format `<value><NL>`
 `<value> ::= Expected current value in NR3 format`

- See Also**
- [":POWer:INRush:APPLY"](#) on page 656
 - [":POWer:SIGNals:AUTOsetup"](#) on page 683
 - [":POWer:SIGNals:OVERshoot"](#) on page 693
 - [":POWer:SIGNals:VMAXimum:INRush"](#) on page 694
 - [":POWer:SIGNals:SOURce:CURRENT<i>"](#) on page 700
 - [":POWer:SIGNals:SOURce:VOLTage<i>"](#) on page 701

:POWer:SIGNals:OVERshoot

N (see [page 1384](#))

Command Syntax :POWer:SIGNals:OVERshoot <percent>

<percent> ::= percent of overshoot value in NR1 format

The :POWer:SIGNals:OVERshoot command specifies the percent of overshoot of the output voltage. This value is used to determine the settling band value for the transient response and to adjust the vertical scale of the oscilloscope.

Query Syntax :POWer:SIGNals:OVERshoot?

The :POWer:SIGNals:OVERshoot query returns the overshoot percent setting.

Return Format <percent><NL>

<percent> ::= percent of overshoot value in NR1 format

- See Also**
- [":POWer:TRANsient:APPLY"](#) on page 710
 - [":POWer:SIGNals:AUTOsetup"](#) on page 683
 - [":POWer:SIGNals:DURATION:TRANsient"](#) on page 691
 - [":POWer:SIGNals:IEXpected"](#) on page 692
 - [":POWer:SIGNals:VSTeady:TRANsient"](#) on page 699
 - [":POWer:SIGNals:SOURce:CURREnt<i>"](#) on page 700
 - [":POWer:SIGNals:SOURce:VOLTage<i>"](#) on page 701

:POWer:SIGNals:VMAXimum:INRush

N (see [page 1384](#))

Command Syntax :POWer:SIGNals:VMAXimum:INRush <value>[suffix]

<value> ::= Maximum expected input Voltage in NR3 format

[suffix] ::= {V | mV}

The :POWer:SIGNals:VMAXimum:INRush command specifies the maximum expected input voltage. This value is used to set the vertical scale of the channel probing voltage for inrush current analysis.

When the :POWer:ITYPE is DC, this command defines the maximum DC input voltage amplitude value. The values can be negative.

When the :POWer:ITYPE is AC, this command defines the maximum peak-to-peak input voltage. Only positive values are allowed.

Query Syntax :POWer:SIGNals:VMAXimum:INRush?

The :POWer:SIGNals:VMAXimum:INRush query returns the expected maximum input voltage setting.

Return Format <value><NL>

<value> ::= Maximum expected input Voltage in NR3 format

- See Also**
- [":POWer:ITYPE"](#) on page 659
 - [":POWer:INRush:APPLY"](#) on page 656
 - [":POWer:SIGNals:AUTOsetup"](#) on page 683
 - [":POWer:SIGNals:IEXpected"](#) on page 692
 - [":POWer:SIGNals:OVERshoot"](#) on page 693
 - [":POWer:SIGNals:SOURce:CURRENT<i>"](#) on page 700
 - [":POWer:SIGNals:SOURce:VOLTage<i>"](#) on page 701

:POWer:SIGNals:VMAXimum:ONOFF:OFF

N (see [page 1384](#))

Command Syntax :POWer:SIGNals:VMAXimum:ONOFF:OFF <value>[suffix]
 <value> ::= Maximum expected input Voltage in NR3 format
 [suffix] ::= {V | mV}

The :POWer:SIGNals:VMAXimum:ONOFF:OFF command specifies the maximum expected input voltage. This value is used to set the vertical scale of the channel probing voltage for turn off analysis.

When the :POWer:ITYPE is DC, this command defines the maximum DC input voltage amplitude value. The values can be negative.

When the :POWer:ITYPE is AC, this command defines the maximum peak-to-peak input voltage. Only positive values are allowed.

Query Syntax :POWer:SIGNals:VMAXimum:ONOFF:OFF?

The :POWer:SIGNals:VMAXimum:ONOFF:OFF query returns the expected maximum input voltage setting.

Return Format <value><NL>
 <value> ::= Maximum expected input Voltage in NR3 format

- See Also**
- [":POWer:ITYPE"](#) on page 659
 - [":POWer:ONOFF:APPLY"](#) on page 663
 - [":POWer:SIGNals:AUTOsetup"](#) on page 683
 - [":POWer:SIGNals:DURATION:ONOFF:OFF"](#) on page 688
 - [":POWer:SIGNals:IEXpected"](#) on page 692
 - [":POWer:SIGNals:OVERshoot"](#) on page 693
 - [":POWer:SIGNals:VSTEady:ONOFF:OFF"](#) on page 697
 - [":POWer:SIGNals:SOURce:CURREnt<i>"](#) on page 700
 - [":POWer:SIGNals:SOURce:VOLTage<i>"](#) on page 701

:POWer:SIGNals:VMAXimum:ONOFF:ON

N (see [page 1384](#))

Command Syntax :POWer:SIGNals:VMAXimum:ONOFF:ON <value>[suffix]
 <value> ::= Maximum expected input Voltage in NR3 format
 [suffix] ::= {V | mV}

The :POWer:SIGNals:VMAXimum:ONOFF:ON command specifies the maximum expected input voltage. This value is used to set the vertical scale of the channel probing voltage for turn on analysis.

When the :POWer:ITYPE is DC, this command defines the maximum DC input voltage amplitude value. The values can be negative.

When the :POWer:ITYPE is AC, this command defines the maximum peak-to-peak input voltage. Only positive values are allowed.

Query Syntax :POWer:SIGNals:VMAXimum:ONOFF:ON?

The :POWer:SIGNals:VMAXimum:ONOFF:ON query returns the expected maximum input voltage setting.

Return Format <value><NL>
 <value> ::= Maximum expected input Voltage in NR3 format

- See Also**
- [":POWer:ITYPE"](#) on page 659
 - [":POWer:ONOFF:APPLY"](#) on page 663
 - [":POWer:SIGNals:AUTOsetup"](#) on page 683
 - [":POWer:SIGNals:DURATION:ONOFF:ON"](#) on page 689
 - [":POWer:SIGNals:IEXpected"](#) on page 692
 - [":POWer:SIGNals:OVERshoot"](#) on page 693
 - [":POWer:SIGNals:VSTEady:ONOFF:ON"](#) on page 698
 - [":POWer:SIGNals:SOURce:CURREnt<i>"](#) on page 700
 - [":POWer:SIGNals:SOURce:VOLTage<i>"](#) on page 701

:POWer:SIGNals:VSTeady:ONOFF:OFF

N (see [page 1384](#))

Command Syntax :POWer:SIGNals:VSTeady:ONOFF:OFF <value>[suffix]

<value> ::= Expected steady state output Voltage value in NR3 format

[suffix] ::= {V | mV}

The :POWer:SIGNals:VSTeady:ONOFF:OFF command specifies the expected steady state output DC voltage of the power supply for turn off analysis.

Query Syntax :POWer:SIGNals:VSTeady:ONOFF:OFF?

The :POWer:SIGNals:VSTeady:ONOFF:OFF query returns the expected steady state voltage setting.

Return Format <value><NL>

<value> ::= Expected steady state output Voltage value in NR3 format

- See Also**
- [":POWer:ONOFF:APPLy"](#) on page 663
 - [":POWer:SIGNals:AUTOsetup"](#) on page 683
 - [":POWer:SIGNals:DURation:ONOFF:OFF"](#) on page 688
 - [":POWer:SIGNals:IEXpected"](#) on page 692
 - [":POWer:SIGNals:OVERshoot"](#) on page 693
 - [":POWer:SIGNals:VMAXimum:ONOFF:OFF"](#) on page 695
 - [":POWer:SIGNals:SOURce:CURREnt<i>"](#) on page 700
 - [":POWer:SIGNals:SOURce:VOLTage<i>"](#) on page 701

:POWer:SIGNals:VSTeady:ONOff:ON

N (see [page 1384](#))

Command Syntax :POWer:SIGNals:VSTeady:ONOff:ON <value> [suffix]

<value> ::= Expected steady state output Voltage value in NR3 format

[suffix] ::= {V | mV}

The :POWer:SIGNals:VSTeady:ONOff:ON command specifies the expected steady state output DC voltage of the power supply for turn on analysis.

Query Syntax :POWer:SIGNals:VSTeady:ONOff:ON?

The :POWer:SIGNals:VSTeady:ONOff:ON query returns the expected steady state voltage setting.

Return Format <value><NL>

<value> ::= Expected steady state output Voltage value in NR3 format

- See Also**
- [":POWer:ONOff:APPLy"](#) on page 663
 - [":POWer:SIGNals:AUTosetup"](#) on page 683
 - [":POWer:SIGNals:DUration:ONOff:ON"](#) on page 689
 - [":POWer:SIGNals:IXPected"](#) on page 692
 - [":POWer:SIGNals:OVERshoot"](#) on page 693
 - [":POWer:SIGNals:VMAXimum:ONOff:ON"](#) on page 696
 - [":POWer:SIGNals:SOURce:CURRent<i>"](#) on page 700
 - [":POWer:SIGNals:SOURce:VOLTage<i>"](#) on page 701

:POWer:SIGNals:VSTeady:TRANsient

N (see [page 1384](#))

Command Syntax :POWer:SIGNals:VSTeady:TRANsient <value>[suffix]

<value> ::= Expected steady state output Voltage value in NR3 format

[suffix] ::= {V | mV}

The :POWer:SIGNals:VSTeady:TRANsient command specifies the expected steady state output DC voltage of the power supply for transient response analysis.

This value is used along with the overshoot percentage to specify the settling band for the transient response and to adjust the vertical scale of the oscilloscope.

Query Syntax :POWer:SIGNals:VSTeady:TRANsient?

The :POWer:SIGNals:VSTeady:TRANsient query returns the expected steady state voltage setting.

Return Format <value><NL>

<value> ::= Expected steady state output Voltage value in NR3 format

- See Also**
- [":POWer:TRANsient:APPLY"](#) on page 710
 - [":POWer:SIGNals:AUTOsetup"](#) on page 683
 - [":POWer:SIGNals:DURATION:TRANsient"](#) on page 691
 - [":POWer:SIGNals:IEXpected"](#) on page 692
 - [":POWer:SIGNals:OVERshoot"](#) on page 693
 - [":POWer:SIGNals:SOURce:CURREnt<i>"](#) on page 700
 - [":POWer:SIGNals:SOURce:VOLTage<i>"](#) on page 701

:POWer:SIGNals:SOURce:CURRent<i>

N (see [page 1384](#))

Command Syntax :POWer:SIGNals:SOURce:CURRent<i> <source>

<i> ::= 1, 2 in NR1 format

<source> ::= CHANnel<n>

<n> ::= 1 to (# analog channels) in NR1 format

The :POWer:SIGNals:SOURce:CURRent<i> command specifies the first, and perhaps second, current source channel to be used in the power analysis.

Query Syntax :POWer:SIGNals:SOURce:CURRent<i>?

The :POWer:SIGNals:SOURce:CURRent<i> query returns the current source channel setting.

Return Format <source><NL>

<source> ::= CHANnel<n>

<n> ::= 1 to (# analog channels) in NR1 format

- See Also**
- [":POWer:SIGNals:AUTOsetup"](#) on page 683
 - [":POWer:SIGNals:CYCLes:HARMonics"](#) on page 684
 - [":POWer:SIGNals:CYCLes:QUALity"](#) on page 685
 - [":POWer:SIGNals:DURation:EFFiciency"](#) on page 686
 - [":POWer:SIGNals:DURation:MODulation"](#) on page 687
 - [":POWer:SIGNals:DURation:ONOFF:OFF"](#) on page 688
 - [":POWer:SIGNals:DURation:ONOFF:ON"](#) on page 689
 - [":POWer:SIGNals:DURation:RIPple"](#) on page 690
 - [":POWer:SIGNals:DURation:TRANsient"](#) on page 691
 - [":POWer:SIGNals:IEXpected"](#) on page 692
 - [":POWer:SIGNals:OVERshoot"](#) on page 693
 - [":POWer:SIGNals:VMAXimum:INRush"](#) on page 694
 - [":POWer:SIGNals:VMAXimum:ONOFF:OFF"](#) on page 695
 - [":POWer:SIGNals:VMAXimum:ONOFF:ON"](#) on page 696
 - [":POWer:SIGNals:VSTeady:ONOFF:OFF"](#) on page 697
 - [":POWer:SIGNals:VSTeady:ONOFF:ON"](#) on page 698
 - [":POWer:SIGNals:VSTeady:TRANsient"](#) on page 699
 - [":POWer:SIGNals:SOURce:VOLTage<i>"](#) on page 701

:POWER:SIGNals:SOURce:VOLTage<i>

N (see [page 1384](#))

Command Syntax :POWER:SIGNals:SOURce:VOLTage<i> <source>

<i> ::= 1, 2 in NR1 format

<source> ::= CHANnel<n>

<n> ::= 1 to (# analog channels) in NR1 format

The :POWER:SIGNals:SOURce:VOLTage<i> command specifies the first, and perhaps second, voltage source channel to be used in the power analysis.

Query Syntax :POWER:SIGNals:SOURce:VOLTage<i>?

The :POWER:SIGNals:SOURce:VOLTage<i> query returns the voltage source channel setting.

Return Format <source><NL>

<source> ::= CHANnel<n>

<n> ::= 1 to (# analog channels) in NR1 format

- See Also**
- [":POWER:SIGNals:AUTOsetup"](#) on page 683
 - [":POWER:SIGNals:CYCLes:HARMonics"](#) on page 684
 - [":POWER:SIGNals:CYCLes:QUALity"](#) on page 685
 - [":POWER:SIGNals:DURation:EFFiciency"](#) on page 686
 - [":POWER:SIGNals:DURation:MODulation"](#) on page 687
 - [":POWER:SIGNals:DURation:ONOFF:OFF"](#) on page 688
 - [":POWER:SIGNals:DURation:ONOFF:ON"](#) on page 689
 - [":POWER:SIGNals:DURation:RIPple"](#) on page 690
 - [":POWER:SIGNals:DURation:TRANsient"](#) on page 691
 - [":POWER:SIGNals:IEXpected"](#) on page 692
 - [":POWER:SIGNals:OVERshoot"](#) on page 693
 - [":POWER:SIGNals:VMAXimum:INRush"](#) on page 694
 - [":POWER:SIGNals:VMAXimum:ONOFF:OFF"](#) on page 695
 - [":POWER:SIGNals:VMAXimum:ONOFF:ON"](#) on page 696
 - [":POWER:SIGNals:VSTeady:ONOFF:OFF"](#) on page 697
 - [":POWER:SIGNals:VSTeady:ONOFF:ON"](#) on page 698
 - [":POWER:SIGNals:VSTeady:TRANsient"](#) on page 699
 - [":POWER:SIGNals:SOURce:CURRent<i>"](#) on page 700

:POWer:SLEW:APPLY

N (see [page 1384](#))

Command Syntax :POWer:SLEW:APPLY

The :POWer:SLEW:APPLY command applies the slew rate analysis.

See Also • [":POWer:SLEW:SOURce"](#) on page 703

:POWer:SLEW:SOURce

N (see [page 1384](#))

Command Syntax :POWer:SLEW:SOURce <source>

<source> ::= {V | I}

The :POWer:SLEW:SOURce command selects either the voltage source or the current source as the source for the slew rate analysis.

Query Syntax :POWer:SLEW:SOURce?

The :POWer:SLEW:SOURce query returns the selected source for the slew rate analysis.

Return Format <source><NL>

<source> ::= {V | I}

See Also • [":POWer:SLEW:APPLY"](#) on page 702

:POWer:SWITCh:APPLy

N (see [page 1384](#))

Command Syntax :POWer:SWITCh:APPLy

The :POWer:SWITCh:APPLy command applies the switching loss analysis using the conduction calculation method, V reference, and I reference settings.

- See Also**
- [":POWer:SWITCh:CONDuction"](#) on page 705
 - [":POWer:SWITCh:IREFERENCE"](#) on page 706
 - [":POWer:SWITCh:RDS"](#) on page 707
 - [":POWer:SWITCh:VCE"](#) on page 708
 - [":POWer:SWITCh:VREFERENCE"](#) on page 709
 - [":MEASure:ELOSs"](#) on page 566
 - [":MEASure:PLOSs"](#) on page 573

:POWer:SWITCh:CONDUction

N (see [page 1384](#))

Command Syntax :POWer:SWITCh:CONDUction <conduction>

<conduction> ::= {WAVeform | RDS | VCE}

The :POWer:SWITCh:CONDUction command specifies the conduction calculation method:

- WAVEform – The Power waveform uses the original voltage waveform data, and the calculation is: $P = V \times I$
- RDS – Rds(on) – The Power waveform includes error correction:
 - In the On Zone (where the voltage level is below V Ref) – the Power calculation is: $P = Id2 \times Rds(on)$
Specify Rds(on) using the :POWer:SWITCh:RDS command.
 - In the Off Zone (where the current level is below I Ref) – the Power calculation is: $P = 0$ Watt.
- VCE – Vce(sat) – The Power waveform includes error correction:
 - In the On Zone (where the voltage level is below V Ref) – the Power calculation is: $P = Vce(sat) \times Ic$
Specify Vce(sat) using the :POWer:SWITCh:VCE command.
 - In the Off Zone (where the current level is below I Ref) – the Power calculation is: $P = 0$ Watt.

Query Syntax :POWer:SWITCh:CONDUction?

The :POWer:SWITCh:CONDUction query returns the conduction calculation method.

Return Format <conduction><NL>

<conduction> ::= {WAV | RDS | VCE}

- See Also**
- [":POWer:SWITCh:APPLY"](#) on page 704
 - [":POWer:SWITCh:IREference"](#) on page 706
 - [":POWer:SWITCh:RDS"](#) on page 707
 - [":POWer:SWITCh:VCE"](#) on page 708
 - [":POWer:SWITCh:VREference"](#) on page 709

:POWer:SWITCh:IREFERENCE

N (see [page 1384](#))

Command Syntax :POWer:SWITCh:IREFERENCE <percent>
<percent> ::= percent in NR1 format

The :POWer:SWITCh:IREFERENCE command to specify the current switching level for the start of switching edges. The value is in percentage of the maximum switch current.

You can adjust this value to ignore noise floors or null offset that is difficult to eliminate in current probes.

This value specifies the threshold that is used to determine the switching edges.

Query Syntax :POWer:SWITCh:IREFERENCE?

The :POWer:SWITCh:IREFERENCE query returns the current switching level percent value.

Return Format <percent><NL>

<percent> ::= percent in NR1 format

- See Also**
- [":POWer:SWITCh:APPLY"](#) on page 704
 - [":POWer:SWITCh:CONDUCTION"](#) on page 705
 - [":POWer:SWITCh:RDS"](#) on page 707
 - [":POWer:SWITCh:VCE"](#) on page 708
 - [":POWer:SWITCh:VREFERENCE"](#) on page 709

:POWer:SWITCh:RDS

N (see [page 1384](#))

Command Syntax :POWer:SWITCh:RDS <value>[suffix]

<value> ::= Rds(on) value in NR3 format

[suffix] ::= {OHM | mOHM}

The :POWer:SWITCh:RDS command specifies the Rds(on) value when the RDS conduction calculation method is chosen (by :POWer:SWITCh:CONDUction).

Query Syntax :POWer:SWITCh:RDS?

The :POWer:SWITCh:RDS query returns the Rds(on) value.

Return Format <value><NL>

<value> ::= Rds(on) value in NR3 format

- See Also**
- [":POWer:SWITCh:APPLY"](#) on page 704
 - [":POWer:SWITCh:CONDUction"](#) on page 705
 - [":POWer:SWITCh:IREFERENCE"](#) on page 706
 - [":POWer:SWITCh:VCE"](#) on page 708
 - [":POWer:SWITCh:VREFERENCE"](#) on page 709

:POWer:SWITCh:VCE

N (see [page 1384](#))

Command Syntax :POWer:SWITCh:VCE <value>[suffix]

<value> ::= Vce(sat) value in NR3 format

[suffix] ::= {V | mV}

The :POWer:SWITCh:VCE command specifies the Vce(sat) value when the VCE conduction calculation method is chosen (by :POWer:SWITCh:CONDUction).

Query Syntax :POWer:SWITCh:VCE?

The :POWer:SWITCh:VCE query returns the Vce(sat) value.

Return Format <value><NL>

<value> ::= Vce(sat) value in NR3 format

- See Also**
- [":POWer:SWITCh:APPLy"](#) on page 704
 - [":POWer:SWITCh:CONDUction"](#) on page 705
 - [":POWer:SWITCh:IREFERENCE"](#) on page 706
 - [":POWer:SWITCh:RDS"](#) on page 707
 - [":POWer:SWITCh:VREFERENCE"](#) on page 709

:POWer:SWITCh:VREFeRence

N (see [page 1384](#))

Command Syntax :POWer:SWITCh:VREFeRence <percent>
 <percent> ::= percent in NR1 format

The :POWer:SWITCh:VREFeRence command to specify the voltage switching level for the switching edges. The value is in percentage of the maximum switch voltage.

You can adjust this value to ignore noise floors.

This value specifies the threshold that is used to determine the switching edges.

Query Syntax :POWer:SWITCh:VREFeRence?

The :POWer:SWITCh:VREFeRence query returns the voltage switching level percent value.

Return Format <percent><NL>
 <percent> ::= percent in NR1 format

- See Also**
- [":POWer:SWITCh:APPLY"](#) on page 704
 - [":POWer:SWITCh:CONDUction"](#) on page 705
 - [":POWer:SWITCh:IREFeRence"](#) on page 706
 - [":POWer:SWITCh:RDS"](#) on page 707
 - [":POWer:SWITCh:VCE"](#) on page 708

:POWer:TRANsient:APPLy

N (see [page 1384](#))

Command Syntax :POWer:TRANsient:APPLy

The :POWer:TRANsient:APPLy command applies the transient analysis using the initial current and new current settings.

- See Also**
- [":POWer:TRANsient:EXIT"](#) on page 711
 - [":POWer:TRANsient:IInitial"](#) on page 712
 - [":POWer:TRANsient:INEW"](#) on page 713
 - [":POWer:TRANsient:NEXT"](#) on page 714
 - [":MEASure:TRESponse"](#) on page 578

:POWer:TRANsient:EXIT

N (see [page 1384](#))

Command Syntax :POWer:TRANsient:EXIT

The :POWer:TRANsient:EXIT command exits (stops) the transient analysis.

This command is equivalent to pressing the **Exit** softkey on the oscilloscope front panel during the analysis.

- See Also**
- [":POWer:TRANsient:APPLY"](#) on page 710
 - [":POWer:TRANsient:INitial"](#) on page 712
 - [":POWer:TRANsient:INEW"](#) on page 713
 - [":POWer:TRANsient:NEXT"](#) on page 714

:POWer:TRANsient:IINitial

N (see [page 1384](#))

Command Syntax :POWer:TRANsient:IINitial <value>[suffix]

<value> ::= Initial current value in NR3 format

[suffix] ::= {A | mA}

The :POWer:TRANsient:IINitial command to specify the initial load current value. The initial load current will be used as a reference and to trigger the oscilloscope.

Query Syntax :POWer:TRANsient:IINitial?

The :POWer:TRANsient:IINitial query returns the initial load current value.

Return Format <value><NL>

<value> ::= Initial current value in NR3 format

- See Also**
- [":POWer:SIGNals:VSTeady:TRANsient"](#) on page 699
 - [":POWer:TRANsient:APPLY"](#) on page 710
 - [":POWer:TRANsient:EXIT"](#) on page 711
 - [":POWer:TRANsient:INEW"](#) on page 713
 - [":POWer:TRANsient:NEXT"](#) on page 714

:POWer:TRANsient:INEW

N (see [page 1384](#))

Command Syntax :POWer:TRANsient:INEW <value>[suffix]

<value> ::= New current value in NR3 format

[suffix] ::= {A | mA}

The :POWer:TRANsient:INEW command to specify the new load current value. The new load current will be used as a reference and to trigger the oscilloscope.

Query Syntax :POWer:TRANsient:INEW?

The :POWer:TRANsient:INEW query returns the new load current value.

Return Format <value><NL>

<value> ::= New current value in NR3 format

- See Also**
- [":POWer:TRANsient:APPLY"](#) on page 710
 - [":POWer:TRANsient:EXIT"](#) on page 711
 - [":POWer:TRANsient:IInitial"](#) on page 712
 - [":POWer:TRANsient:NEXT"](#) on page 714

:POWer:TRANsient:NEXT

N (see [page 1384](#))

Command Syntax :POWer:TRANsient:NEXT

The :POWer:TRANsient:NEXT command goes to the next step of the transient analysis.

This command is equivalent to pressing the **Next** softkey on the oscilloscope front panel when prompted during the analysis.

- See Also**
- [":POWer:TRANsient:APPLY"](#) on page 710
 - [":POWer:TRANsient:EXIT"](#) on page 711
 - [":POWer:TRANsient:INInitial"](#) on page 712
 - [":POWer:TRANsient:INEW"](#) on page 713

27 :RECall Commands

Recall previously saved oscilloscope setups, reference waveforms, and masks.

Table 109: RECall Commands Summary

Command	Query	Options and Query Returns
:RECall:ARBitrary:[ST ARt] [<file_spec>] [, <column>] [, <wavegen_id>] (see page 717)	n/a	<file_spec> ::= {<internal_loc> <file_name>} <column> ::= Column in CSV file to load. Column number starts from 1. <internal_loc> ::= 0-3; an integer in NR1 format <file_name> ::= quoted ASCII string <wavegen_id> ::= WGEN1
:RECall:DBC[:START] [<file_name>] [, <serialbus>] (see page 718)	n/a	<file_name> ::= quoted ASCII string If extension included in file name, it must be ".dbc". <serialbus> ::= {SBUS<n>} <n> ::= 1 to (# of serial bus) in NR1 format
:RECall:FIleName <base_name> (see page 719)	:RECall:FIleName? (see page 719)	<base_name> ::= quoted ASCII string
:RECall:LDF[:START] [<file_name>] [, <serialbus>] (see page 720)	n/a	<file_name> ::= quoted ASCII string If extension included in file name, it must be ".ldf". <serialbus> ::= {SBUS<n>} <n> ::= 1 to (# of serial bus) in NR1 format

Table 109 :RECall Commands Summary (continued)

Command	Query	Options and Query Returns
:RECall:MASK[:START] [<file_spec>] (see page 721)	n/a	<file_spec> ::= {<internal_loc> <file_name>} <internal_loc> ::= 0-3; an integer in NR1 format <file_name> ::= quoted ASCII string
:RECall:PWD <path_name> (see page 722)	:RECall:PWD? (see page 722)	<path_name> ::= quoted ASCII string
:RECall:SETup[:START] [<file_spec>] (see page 723)	n/a	<file_spec> ::= {<internal_loc> <file_name>} <internal_loc> ::= 0-9; an integer in NR1 format <file_name> ::= quoted ASCII string
:RECall:WMEMemory<r>[:START] [<file_name>] (see page 724)	n/a	<r> ::= 1 to (# ref waveforms) in NR1 format <file_name> ::= quoted ASCII string If extension included in file name, it must be ".h5".

Introduction to :RECall Commands The :RECall subsystem provides commands to recall previously saved oscilloscope setups, reference waveforms, and masks.

Reporting the Setup

Use :RECall? to query setup information for the RECall subsystem.

Return Format

The following is a sample response from the :RECall? query. In this case, the query was issued following the *RST command.

```
:REC:FIL "scope_0"
```

:RECall:ARbitrary[:START]

N (see [page 1384](#))

Command Syntax :RECall:ARbitrary:[START] [<file_spec>] [, <column>] [, <wavegen_id>]
 <file_spec> ::= {<internal_loc> | <file_name>}
 <column> ::= Column in CSV file to load. Column number starts from 1.
 <wavegen_id> ::= WGEN1 - specifies which wavegen
 <internal_loc> ::= 0-3; an integer in NR1 format
 <file_name> ::= quoted ASCII string

The :RECall:ARbitrary:[START] command recalls an arbitrary waveform.

NOTE

If a file extension is provided as part of a specified <file_name>, it must be ".csv".

For internal locations, the <column> parameter is ignored.

For external (USB storage device) files, the column parameter is optional. If no <column> parameter is entered, and it is a 2-column file, the 2nd column (assumed to be voltage) is automatically be selected. If the <column> parameter is entered, and that column does not exist in the file, the operation fails.

When recalling arbitrary waveforms (from an external USB storage device) that were not saved from the oscilloscope, be aware that the oscilloscope uses a maximum of 8192 points for an arbitrary waveform. For more efficient recalls, make sure your arbitrary waveforms are 8192 points or less.

The <wavegen_id> parameter specifies which waveform generator to recall the arbitrary waveform into.

- See Also**
- ["Introduction to :RECall Commands"](#) on page 716
 - [":RECall:FILENAME"](#) on page 719
 - [":RECall:PWD"](#) on page 722
 - [":SAVE:ARbitrary\[:START\]"](#) on page 729

:RECall:DBC[:START]

N (see [page 1384](#))

Command Syntax :RECall:DBC[:START] [<file_name>] [, <serialbus>]
 <file_name> ::= quoted ASCII string
 <serialbus> ::= {SBUS<n>}
 <n> ::= 1 to (# of serial bus) in NR1 format

The :RECall:DBC[:START] command loads a CAN DBC (communication database) symbolic data file into the oscilloscope.

NOTE

If a file extension is provided as part of a specified <file_name>, it must be ".dbc".

The <serialbus> parameter specifies which serial decode waveform the CAN symbolic data will be loaded for.

- See Also**
- ["Introduction to :RECall Commands"](#) on page 716
 - [":RECall:FILENAME"](#) on page 719
 - [":SBUS<n>:CAN:TRIGGER"](#) on page 794
 - [":SBUS<n>:CAN:TRIGGER:SYMBOLIC:MESSAGE"](#) on page 804
 - [":SBUS<n>:CAN:TRIGGER:SYMBOLIC:SIGNAL"](#) on page 805
 - [":SBUS<n>:CAN:TRIGGER:SYMBOLIC:VALUE"](#) on page 806
 - [":SEARCH:SERIAL:CAN:MODE"](#) on page 1007
 - [":SEARCH:SERIAL:CAN:SYMBOLIC:MESSAGE"](#) on page 1013
 - [":SEARCH:SERIAL:CAN:SYMBOLIC:SIGNAL"](#) on page 1014
 - [":SEARCH:SERIAL:CAN:SYMBOLIC:VALUE"](#) on page 1015

:RECall:FILEname

N (see [page 1384](#))

Command Syntax :RECall:FILEname <base_name>

<base_name> ::= quoted ASCII string

The :RECall:FILEname command specifies the source for any RECall operations.

NOTE

This command specifies a file's base name only, without path information or an extension.

Query Syntax :RECall:FILEname?

The :RECall:FILEname? query returns the current RECall filename.

Return Format <base_name><NL>

<base_name> ::= quoted ASCII string

- See Also**
- ["Introduction to :RECall Commands"](#) on page 716
 - [":RECall:SETup\[:START\]"](#) on page 723
 - [":SAVE:FILEname"](#) on page 730

:RECall:LDF[:START]

N (see [page 1384](#))

Command Syntax :RECall:LDF[:START] [<file_name>] [, <serialbus>]
 <file_name> ::= quoted ASCII string
 <serialbus> ::= {SBUS<n>}
 <n> ::= 1 to (# of serial bus) in NR1 format

The :RECall:LDF[:START] command loads a LIN description file (LDF) symbolic data file into the oscilloscope.

NOTE

If a file extension is provided as part of a specified <file_name>, it must be ".ldf".

The <serialbus> parameter specifies which serial decode waveform the LIN symbolic data will be loaded for.

- See Also**
- ["Introduction to :RECall Commands"](#) on page 716
 - [":RECall:FILENAME"](#) on page 719
 - [":SBUS<n>:LIN:TRIGger"](#) on page 881
 - [":SBUS<n>:LIN:TRIGger:SYMBOLic:FRAME"](#) on page 887
 - [":SBUS<n>:LIN:TRIGger:SYMBOLic:SIGNal"](#) on page 888
 - [":SBUS<n>:LIN:TRIGger:SYMBOLic:VALue"](#) on page 889
 - [":SEARCH:SERial:LIN:MODE"](#) on page 1037
 - [":SEARCH:SERial:LIN:SYMBOLic:FRAME"](#) on page 1041
 - [":SEARCH:SERial:LIN:SYMBOLic:SIGNal"](#) on page 1042
 - [":SEARCH:SERial:LIN:SYMBOLic:VALue"](#) on page 1043

:RECall:MASK[:START]

N (see [page 1384](#))

Command Syntax :RECall:MASK[:START] [<file_spec>]
 <file_spec> ::= {<internal_loc> | <file_name>}
 <internal_loc> ::= 0-3; an integer in NR1 format
 <file_name> ::= quoted ASCII string
 The :RECall:MASK[:START] command recalls a mask.

NOTE

If a file extension is provided as part of a specified <file_name>, it must be ".msk".

- See Also**
- ["Introduction to :RECall Commands"](#) on page 716
 - [":RECall:FILENAME"](#) on page 719
 - [":RECall:PWD"](#) on page 722
 - [":SAVE:MASK\[:START\]"](#) on page 737
 - [":MTEST:DATA"](#) on page 596

:RECall:PWD

N (see [page 1384](#))

Command Syntax :RECall:PWD <path_name>
 <path_name> ::= quoted ASCII string

The :RECall:PWD command sets the present working directory for recall operations.

NOTE

Presently, the internal "/User Files" directory you see in the oscilloscope's front panel user interface is the "\Agilent Flash" directory you see in the remote interface.

Query Syntax :RECall:PWD?

The :RECall:PWD? query returns the currently set working directory for recall operations.

Return Format <path_name><NL>
 <path_name> ::= quoted ASCII string

- See Also**
- ["Introduction to :RECall Commands"](#) on page 716
 - [":SAVE:PWD"](#) on page 740

:RECall:SETup[:START]

N (see [page 1384](#))

Command Syntax :RECall:SETup[:START] [<file_spec>]
 <file_spec> ::= {<internal_loc> | <file_name>}
 <internal_loc> ::= 0-9; an integer in NR1 format
 <file_name> ::= quoted ASCII string

The :RECall:SETup[:START] command recalls an oscilloscope setup.

NOTE

If a file extension is provided as part of a specified <file_name>, it must be ".scp".

-
- See Also**
- ["Introduction to :RECall Commands"](#) on page 716
 - [":RECall:FILENAME"](#) on page 719
 - [":RECall:PWD"](#) on page 722
 - [":SAVE\[:SETup\[:START\]\]"](#) on page 747

:RECall:WMEMory<r>[:START]

N (see [page 1384](#))

Command Syntax :RECall:WMEMory<r>[:START] [<file_name>]
 <r> ::= 1 to (# ref waveforms) in NR1 format
 <file_name> ::= quoted ASCII string

The :RECall:WMEMory<r>[:START] command recalls a reference waveform.

NOTE

If a file extension is provided as part of a specified <file_name>, it must be ".h5".

- See Also**
- ["Introduction to :RECall Commands"](#) on page 716
 - [":RECall:FILEname"](#) on page 719
 - [":SAVE:WMEMory\[:START\]"](#) on page 754

28 :SAVE Commands

Save oscilloscope setups, screen images, and data. See "[Introduction to :SAVE Commands](#)" on page 727.

Table 110: :SAVE Commands Summary

Command	Query	Options and Query Returns
:SAVE:ARBitrary:[STARt] [<file_spec>][,<wavegen_id>] (see page 729)	n/a	<file_spec> ::= {<internal_loc> <file_name>} <internal_loc> ::= 0-3; an integer in NR1 format <file_name> ::= quoted ASCII string <wavegen_id> ::= WGEN1
:SAVE:FIleName <base_name> (see page 730)	:SAVE:FIleName? (see page 730)	<base_name> ::= quoted ASCII string
:SAVE:IMAGe[:START] [<file_name>] (see page 731)	n/a	<file_name> ::= quoted ASCII string
:SAVE:IMAGe:FACTors { {0 OFF} {1 ON} } (see page 732)	:SAVE:IMAGe:FACTors? (see page 732)	{0 1}
:SAVE:IMAGe:FORMat <format> (see page 733)	:SAVE:IMAGe:FORMat? (see page 733)	<format> ::= { {BMP BMP24bit} BMP8bit PNG NONE }
:SAVE:IMAGe:INKSaver { {0 OFF} {1 ON} } (see page 734)	:SAVE:IMAGe:INKSaver? (see page 734)	{0 1}
:SAVE:IMAGe:PALette <palette> (see page 735)	:SAVE:IMAGe:PALette? (see page 735)	<palette> ::= {COLor GRAYscale}
:SAVE:LISTer[:START] [<file_name>] (see page 736)	n/a	<file_name> ::= quoted ASCII string

Table 110:SAVE Commands Summary (continued)

Command	Query	Options and Query Returns
:SAVE:MASK[:START] [<file_spec>] (see page 737)	n/a	<file_spec> ::= {<internal_loc> <file_name>} <internal_loc> ::= 0-3; an integer in NR1 format <file_name> ::= quoted ASCII string
:SAVE:MULTi[:START] [<file_name>] (see page 738)	n/a	<file_name> ::= quoted ASCII string
:SAVE:POWer[:START] [<file_name>] (see page 739)	n/a	<file_name> ::= quoted ASCII string
:SAVE:PWD <path_name> (see page 740)	:SAVE:PWD? (see page 740)	<path_name> ::= quoted ASCII string
:SAVE:RESults:[START] [<file_spec>] (see page 741)	n/a	<file_name> ::= quoted ASCII string
:SAVE:RESults:FORMat: CURSor {{0 OFF} {1 ON}} (see page 742)	:SAVE:RESults:FORMat: CURSor? (see page 742)	{0 1}
:SAVE:RESults:FORMat: MASK {{0 OFF} {1 ON}} (see page 743)	:SAVE:RESults:FORMat: MASK? (see page 743)	{0 1}
:SAVE:RESults:FORMat: MEASurement {{0 OFF} {1 ON}} (see page 744)	:SAVE:RESults:FORMat: MEASurement? (see page 744)	{0 1}
:SAVE:RESults:FORMat: SEARch {{0 OFF} {1 ON}} (see page 745)	:SAVE:RESults:FORMat: SEARch? (see page 745)	{0 1}
:SAVE:RESults:FORMat: SEGmented {{0 OFF} {1 ON}} (see page 746)	:SAVE:RESults:FORMat: SEGmented? (see page 746)	{0 1}
:SAVE:SETup[:START] [<file_spec>] (see page 747)	n/a	<file_spec> ::= {<internal_loc> <file_name>} <internal_loc> ::= 0-9; an integer in NR1 format <file_name> ::= quoted ASCII string

Table 110:SAVE Commands Summary (continued)

Command	Query	Options and Query Returns
:SAVE:WAVEform[:START] [<file_name>] (see page 748)	n/a	<file_name> ::= quoted ASCII string
:SAVE:WAVEform:FORMat <format> (see page 749)	:SAVE:WAVEform:FORMat? (see page 749)	<format> ::= {ASCIixy CSV BINary NONE}
:SAVE:WAVEform:LENGth <length> (see page 750)	:SAVE:WAVEform:LENGth? (see page 750)	<length> ::= 100 to max. length; an integer in NR1 format
:SAVE:WAVEform:LENGth:MAX {{0 OFF} {1 ON}} (see page 751)	:SAVE:WAVEform:LENGth:MAX? (see page 751)	{0 1}
:SAVE:WAVEform:SEGMent <option> (see page 752)	:SAVE:WAVEform:SEGMent? (see page 752)	<option> ::= {ALL CURRent}
:SAVE:WMEMory:SOURce <source> (see page 753)	:SAVE:WMEMory:SOURce? (see page 753)	<source> ::= {CHANnel<n> FUNCTION<m> MATH<m> WMEMory<r>} <n> ::= 1 to (# analog channels) in NR1 format <m> ::= 1 to (# math functions) in NR1 format <r> ::= 1 to (# ref waveforms) in NR1 format NOTE: Only ADD or SUBtract math operations can be saved as reference waveforms. <return_value> ::= <source>
:SAVE:WMEMory[:START] [<file_name>] (see page 754)	n/a	<file_name> ::= quoted ASCII string If extension included in file name, it must be ".h5".

Introduction to :SAVE Commands

The :SAVE subsystem provides commands to save oscilloscope setups, screen images, and data.

:SAV is an acceptable short form for :SAVE.

Reporting the Setup

Use :SAVE? to query setup information for the SAVE subsystem.

Return Format

The following is a sample response from the :SAVE? query. In this case, the query was issued following the *RST command.

```
:SAVE:FIL " ";:SAVE:IMAG:AREA GRAT;FACT 0;FORM TIFF;INKS 0;PAL  
MON;:SAVE:PWD "C:/setups/";:SAVE:WAV:FORM NONE;LENG 1000;SEGM CURR
```

:SAVE:ARbitrary[:START]

N (see [page 1384](#))

Command Syntax :SAVE:ARbitrary:[START] [<file_spec>] [, <wavegen_id>]
 <file_spec> ::= {<internal_loc> | <file_name>}
 <internal_loc> ::= 0-3; an integer in NR1 format
 <file_name> ::= quoted ASCII string
 <wavegen_id> ::= WGEN1

The :SAVE:ARbitrary:[START] command saves the current arbitrary waveform to an internal location or a file on a USB storage device.

The <wavegen_id> parameter specifies which waveform generator to save the arbitrary waveform from.

NOTE

If a file extension is provided as part of a specified <file_name>, it must be ".csv".

- See Also**
- ["Introduction to :SAVE Commands"](#) on page 727
 - [":SAVE:FILENAME"](#) on page 730
 - [":SAVE:PWD"](#) on page 740
 - [":RECALL:ARbitrary\[:START\]"](#) on page 717

:SAVE:FILEname

N (see [page 1384](#))

Command Syntax :SAVE:FILEname <base_name>
 <base_name> ::= quoted ASCII string

The :SAVE:FILEname command specifies the source for any SAVE operations.

NOTE

This command specifies a file's base name only, without path information or an extension.

Query Syntax :SAVE:FILEname?

The :SAVE:FILEname? query returns the current SAVE filename.

Return Format <base_name><NL>
 <base_name> ::= quoted ASCII string

- See Also**
- ["Introduction to :SAVE Commands"](#) on page 727
 - [":SAVE:IMAGe\[:START\]"](#) on page 731
 - [":SAVE\[:SETup\[:START\]\]"](#) on page 747
 - [":SAVE:WAVEform\[:START\]"](#) on page 748
 - [":SAVE:PWD"](#) on page 740
 - [":RECall:FILEname"](#) on page 719

:SAVE:IMAGe[:START]

N (see [page 1384](#))

Command Syntax :SAVE:IMAGe[:START] [<file_name>
 <file_name> ::= quoted ASCII string

The :SAVE:IMAGe[:START] command saves an image.

NOTE

Be sure to set the :SAVE:IMAGe:FORMat before saving an image. If the format is NONE, the save image command will not succeed.

NOTE

If a file extension is provided as part of a specified <file_name>, and it does not match the extension expected by the format specified in :SAVE:IMAGe:FORMat, the format will be changed if the extension is a valid image file extension.

NOTE

If the extension ".bmp" is used and the current :SAVE:IMAGe:FORMat is not BMP or BMP8, the format will be changed to BMP.

- See Also**
- ["Introduction to :SAVE Commands"](#) on page 727
 - [":SAVE:IMAGe:FACTors"](#) on page 732
 - [":SAVE:IMAGe:FORMat"](#) on page 733
 - [":SAVE:IMAGe:INKSaver"](#) on page 734
 - [":SAVE:IMAGe:PALette"](#) on page 735
 - [":SAVE:FILename"](#) on page 730

:SAVE:IMAGe:FACTors

N (see [page 1384](#))

Command Syntax `:SAVE:IMAGe:FACTors <factors>`
`<factors> ::= {{OFF | 0} | {ON | 1}}`

The :SAVE:IMAGe:FACTors command controls whether the oscilloscope factors are output along with the image.

NOTE

Factors are written to a separate file with the same path and base name but with the ".txt" extension.

Query Syntax `:SAVE:IMAGe:FACTors?`

The :SAVE:IMAGe:FACTors? query returns a flag indicating whether oscilloscope factors are output along with the image.

Return Format `<factors><NL>`
`<factors> ::= {0 | 1}`

- See Also**
- ["Introduction to :SAVE Commands"](#) on page 727
 - [":SAVE:IMAGe\[:START\]"](#) on page 731
 - [":SAVE:IMAGe:FORMat"](#) on page 733
 - [":SAVE:IMAGe:INKSaver"](#) on page 734
 - [":SAVE:IMAGe:PALette"](#) on page 735

:SAVE:IMAGe:FORMat

N (see [page 1384](#))

Command Syntax :SAVE:IMAGe:FORMat <format>

<format> ::= {{BMP | BMP24bit} | BMP8bit | PNG}

The :SAVE:IMAGe:FORMat command sets the image format type.

Query Syntax :SAVE:IMAGe:FORMat?

The :SAVE:IMAGe:FORMat? query returns the selected image format type.

Return Format <format><NL>

<format> ::= {BMP | BMP8 | PNG | NONE}

When NONE is returned, it indicates that a waveform data file format is currently selected.

- See Also**
- ["Introduction to :SAVE Commands"](#) on page 727
 - [":SAVE:IMAGe\[:START\]"](#) on page 731
 - [":SAVE:IMAGe:FACTors"](#) on page 732
 - [":SAVE:IMAGe:INKSaver"](#) on page 734
 - [":SAVE:IMAGe:PALette"](#) on page 735
 - [":SAVE:WAVEform:FORMat"](#) on page 749

:SAVE:IMAGe:INKSaver

N (see [page 1384](#))

Command Syntax :SAVE:IMAGe:INKSaver <value>

<value> ::= {{OFF | 0} | {ON | 1}}

The :SAVE:IMAGe:INKSaver command controls whether the graticule colors are inverted or not.

Query Syntax :SAVE:IMAGe:INKSaver?

The :SAVE:IMAGe:INKSaver? query returns a flag indicating whether graticule colors are inverted or not.

Return Format <value><NL>

<value> ::= {0 | 1}

- See Also**
- ["Introduction to :SAVE Commands"](#) on page 727
 - [":SAVE:IMAGe\[:START\]"](#) on page 731
 - [":SAVE:IMAGe:FACTors"](#) on page 732
 - [":SAVE:IMAGe:FORMat"](#) on page 733
 - [":SAVE:IMAGe:PALette"](#) on page 735

:SAVE:IMAGe:PALette

N (see [page 1384](#))

Command Syntax :SAVE:IMAGe:PALette <palette>

<palette> ::= {COLor | GRAYscale}

The :SAVE:IMAGe:PALette command sets the image palette color.

Query Syntax :SAVE:IMAGe:PALette?

The :SAVE:IMAGe:PALette? query returns the selected image palette color.

Return Format <palette><NL>

<palette> ::= {COL | GRAY}

- See Also**
- ["Introduction to :SAVE Commands"](#) on page 727
 - [":SAVE:IMAGe\[:START\]"](#) on page 731
 - [":SAVE:IMAGe:FACTors"](#) on page 732
 - [":SAVE:IMAGe:FORMat"](#) on page 733
 - [":SAVE:IMAGe:INKSaver"](#) on page 734

:SAVE:LISTer[:START]

N (see [page 1384](#))

Command Syntax :SAVE:LISTer[:START] [<file_name>]
<file_name> ::= quoted ASCII string

The :SAVE:LISTer[:START] command saves the Lister display data to a file.

NOTE

If a file extension is provided as part of a specified <file_name>, it must be ".csv".

-
- See Also**
- ["Introduction to :SAVE Commands"](#) on page 727
 - [":SAVE:FILENAME"](#) on page 730
 - [Chapter 20](#), “:LISTer Commands,” starting on page 449

:SAVE:MASK[:START]

N (see [page 1384](#))

Command Syntax :SAVE:MASK[:START] [<file_spec>]
 <file_spec> ::= {<internal_loc> | <file_name>}
 <internal_loc> ::= 0-3; an integer in NR1 format
 <file_name> ::= quoted ASCII string
 The :SAVE:MASK[:START] command saves a mask.

NOTE

If a file extension is provided as part of a specified <file_name>, it must be ".msk".

- See Also**
- ["Introduction to :SAVE Commands"](#) on page 727
 - [":SAVE:FILENAME"](#) on page 730
 - [":SAVE:PWD"](#) on page 740
 - [":RECALL:MASK\[:START\]"](#) on page 721
 - [":MTEST:DATA"](#) on page 596

:SAVE:MULTi[:START]**N** (see [page 1384](#))**Command Syntax** :SAVE:MULTi[:START] [<file_name>]

<file_name> ::= quoted ASCII string

The :SAVE:MULTi[:START] command saves multi-channel waveform data to a file. This file can be opened by the N8900A Infiniium Offline oscilloscope analysis software.

NOTE

If a file extension is provided as part of a specified <file_name>, it must be ".h5".

-
- See Also**
- ["Introduction to :SAVE Commands"](#) on page 727
 - [":SAVE:FILENAME"](#) on page 730
 - [":SAVE:PWD"](#) on page 740

:SAVE:POWer[:START]

N (see [page 1384](#))

Command Syntax :SAVE:POWer[:START] [<file_name>]

<file_name> ::= quoted ASCII string

The :SAVE:POWer[:START] command saves the power measurement application's current harmonics analysis results to a file.

NOTE

If a file extension is provided as part of a specified <file_name>, it must be ".csv".

-
- See Also**
- ["Introduction to :SAVE Commands"](#) on page 727
 - [":SAVE:FILENAME"](#) on page 730
 - [Chapter 26](#), ":POWer Commands," starting on page 621

:SAVE:PWD

N (see [page 1384](#))

Command Syntax :SAVE:PWD <path_name>
 <path_name> ::= quoted ASCII string

The :SAVE:PWD command sets the present working directory for save operations.

NOTE

Presently, the internal "/User Files" directory you see in the oscilloscope's front panel user interface is the "\Agilent Flash" directory you see in the remote interface.

Query Syntax :SAVE:PWD?

The :SAVE:PWD? query returns the currently set working directory for save operations.

Return Format <path_name><NL>
 <path_name> ::= quoted ASCII string

- See Also**
- ["Introduction to :SAVE Commands"](#) on page 727
 - [":SAVE:FILENAME"](#) on page 730
 - [":RECALL:PWD"](#) on page 722

:SAVE:RESuLts:[START]

N (see [page 1384](#))

Command Syntax :SAVE:RESuLts:[START] [<file_spec>]
 <file_name> ::= quoted ASCII string

The :SAVE:RESuLts:[START] command saves analysis results to a comma-separated values (*.csv) file on a USB storage device.

Use the :SAVE:RESuLts:FORMat commands to specify the analysis types whose results are saved to the file.

When multiple types of analysis results are selected, they are all saved to the same file and separated by a blank line.

- See Also**
- [":SAVE:RESuLts:FORMat:CURSor"](#) on page 742
 - [":SAVE:RESuLts:FORMat:MASK"](#) on page 743
 - [":SAVE:RESuLts:FORMat:MEASurement"](#) on page 744
 - [":SAVE:RESuLts:FORMat:SEARch"](#) on page 745
 - [":SAVE:RESuLts:FORMat:SEGmented"](#) on page 746

:SAVE:RESuLts:FORMat:CURSor

N (see [page 1384](#))

Command Syntax `:SAVE:RESuLts:FORMat:CURSor {{0 | OFF} | {1 | ON}}`

The `:SAVE:RESuLts:FORMat:CURSor` command specifies whether cursor values will be included when analysis results are saved.

Analysis results are saved using the `:SAVE:RESuLts:[START]` command.

Other `:SAVE:RESuLts:FORMat` commands specify whether other types of analysis results are also saved.

When multiple types of analysis results are saved, they are all saved to the same file and separated by a blank line.

Query Syntax `:SAVE:RESuLts:FORMat:CURSor?`

The `:SAVE:RESuLts:FORMat:CURSor?` query returns whether cursor values will be included when analysis results are saved.

Return Format `<off_on><NL>`

`{0 | 1}`

- See Also**
- [":SAVE:RESuLts:\[START\]"](#) on page 741
 - [":SAVE:RESuLts:FORMat:MASK"](#) on page 743
 - [":SAVE:RESuLts:FORMat:MEASurement"](#) on page 744
 - [":SAVE:RESuLts:FORMat:SEARch"](#) on page 745
 - [":SAVE:RESuLts:FORMat:SEGMented"](#) on page 746

:SAVE:RESuLts:FORMat:MASK

N (see [page 1384](#))

Command Syntax :SAVE:RESuLts:FORMat:MASK {{0 | OFF} | {1 | ON}}

The :SAVE:RESuLts:FORMat:MASK command specifies whether mask statistics will be included when analysis results are saved.

Analysis results are saved using the :SAVE:RESuLts:[START] command.

Other :SAVE:RESuLts:FORMat commands specify whether other types of analysis results are also saved.

When multiple types of analysis results are saved, they are all saved to the same file and separated by a blank line.

Query Syntax :SAVE:RESuLts:FORMat:MASK?

The :SAVE:RESuLts:FORMat:MASK? query returns whether mask statistics will be included when analysis results are saved.

Return Format <off_on><NL>

{0 | 1}

- See Also**
- [":SAVE:RESuLts:\[START\]"](#) on page 741
 - [":SAVE:RESuLts:FORMat:CURSor"](#) on page 742
 - [":SAVE:RESuLts:FORMat:MEASurement"](#) on page 744
 - [":SAVE:RESuLts:FORMat:SEARch"](#) on page 745
 - [":SAVE:RESuLts:FORMat:SEGmented"](#) on page 746

:SAVE:RESuLts:FORMat:MEASurement

N (see [page 1384](#))

Command Syntax :SAVE:RESuLts:FORMat:MEASurement {{0 | OFF} | {1 | ON}}

The :SAVE:RESuLts:FORMat:MEASurement command specifies whether measurement results will be included when analysis results are saved.

Analysis results are saved using the :SAVE:RESuLts:[START] command.

Other :SAVE:RESuLts:FORMat commands specify whether other types of analysis results are also saved.

When multiple types of analysis results are saved, they are all saved to the same file and separated by a blank line.

Query Syntax :SAVE:RESuLts:FORMat:MEASurement?

The :SAVE:RESuLts:FORMat:MEASurement? query returns whether measurement results will be included when analysis results are saved.

Return Format <off_on><NL>

{0 | 1}

- See Also**
- [":SAVE:RESuLts:\[START\]"](#) on page 741
 - [":SAVE:RESuLts:FORMat:CURSor"](#) on page 742
 - [":SAVE:RESuLts:FORMat:MASK"](#) on page 743
 - [":SAVE:RESuLts:FORMat:SEARch"](#) on page 745
 - [":SAVE:RESuLts:FORMat:SEGMented"](#) on page 746

:SAVE:RESuLts:FORMat:SEARCh

N (see [page 1384](#))

Command Syntax :SAVE:RESuLts:FORMat:SEARCh {{0 | OFF} | {1 | ON}}

The :SAVE:RESuLts:FORMat:SEARCh command specifies whether found search event times will be included when analysis results are saved.

Analysis results are saved using the :SAVE:RESuLts:[START] command.

Other :SAVE:RESuLts:FORMat commands specify whether other types of analysis results are also saved.

When multiple types of analysis results are saved, they are all saved to the same file and separated by a blank line.

Query Syntax :SAVE:RESuLts:FORMat:SEARCh?

The :SAVE:RESuLts:FORMat:SEARCh? query returns whether found search event times will be included when analysis results are saved.

Return Format <off_on><NL>

{0 | 1}

- See Also**
- [":SAVE:RESuLts:\[START\]"](#) on page 741
 - [":SAVE:RESuLts:FORMat:CURSor"](#) on page 742
 - [":SAVE:RESuLts:FORMat:MASK"](#) on page 743
 - [":SAVE:RESuLts:FORMat:MEASurement"](#) on page 744
 - [":SAVE:RESuLts:FORMat:SEGmented"](#) on page 746

:SAVE:RESuLts:FORMat:SEGMENTed

N (see [page 1384](#))

Command Syntax `:SAVE:RESuLts:FORMat:SEGMENTed {{0 | OFF} | {1 | ON}}`

The `:SAVE:RESuLts:FORMat:SEGMENTed` command specifies whether segmented memory acquisition times will be included when analysis results are saved.

Analysis results are saved using the `:SAVE:RESuLts:[START]` command.

Other `:SAVE:RESuLts:FORMat` commands specify whether other types of analysis results are also saved.

When multiple types of analysis results are saved, they are all saved to the same file and separated by a blank line.

Query Syntax `:SAVE:RESuLts:FORMat:SEGMENTed?`

The `:SAVE:RESuLts:FORMat:SEGMENTed?` query returns whether segmented memory acquisition times will be included when analysis results are saved.

Return Format `<off_on><NL>`

`{0 | 1}`

- See Also**
- [":SAVE:RESuLts:\[START\]"](#) on page 741
 - [":SAVE:RESuLts:FORMat:CURSor"](#) on page 742
 - [":SAVE:RESuLts:FORMat:MASK"](#) on page 743
 - [":SAVE:RESuLts:FORMat:MEASurement"](#) on page 744
 - [":SAVE:RESuLts:FORMat:SEARch"](#) on page 745

:SAVE[:SETup[:START]]

N (see [page 1384](#))

Command Syntax :SAVE[:SETup[:START]] [<file_spec>]
 <file_spec> ::= {<internal_loc> | <file_name>}
 <internal_loc> ::= 0-9; an integer in NR1 format
 <file_name> ::= quoted ASCII string

The :SAVE[:SETup[:START]] command saves an oscilloscope setup.

NOTE

If a file extension is provided as part of a specified <file_name>, it must be ".scp".

-
- See Also**
- ["Introduction to :SAVE Commands"](#) on page 727
 - [":SAVE:FILENAME"](#) on page 730
 - [":SAVE:PWD"](#) on page 740
 - [":RECall:SETup\[:START\]"](#) on page 723

:SAVE:WAVEform[:START]

N (see [page 1384](#))

Command Syntax :SAVE:WAVEform[:START] [<file_name>]
 <file_name> ::= quoted ASCII string

The :SAVE:WAVEform[:START] command saves oscilloscope waveform data to a file.

NOTE

Be sure to set the :SAVE:WAVEform:FORMat before saving waveform data. If the format is NONE, the save waveform command will not succeed.

NOTE

If a file extension is provided as part of a specified <file_name>, and it does not match the extension expected by the format specified in :SAVE:WAVEform:FORMat, the format will be changed if the extension is a valid waveform file extension.

- See Also**
- ["Introduction to :SAVE Commands"](#) on page 727
 - [":SAVE:WAVEform:FORMat"](#) on page 749
 - [":SAVE:WAVEform:LENGth"](#) on page 750
 - [":SAVE:FILEname"](#) on page 730
 - [":RECall:SETup\[:START\]"](#) on page 723

:SAVE:WAVEform:FORMat

N (see [page 1384](#))

Command Syntax :SAVE:WAVEform:FORMat <format>

<format> ::= {ASCIixy | CSV | BINary}

The :SAVE:WAVEform:FORMat command sets the waveform data format type:

- ASCIixy – creates comma-separated value files for each analog channel that is displayed (turned on). The proper file extension for this format is ".csv".
- CSV – creates one comma-separated value file that contains information for all analog channels that are displayed (turned on). The proper file extension for this format is ".csv".
- BINary – creates an oscilloscope binary data format file. See the *User's Guide* for a description of this format. The proper file extension for this format is ".bin".

Query Syntax :SAVE:WAVEform:FORMat?

The :SAVE:WAVEform:FORMat? query returns the selected waveform data format type.

Return Format <format><NL>

<format> ::= {ASC | CSV | BIN | NONE}

When NONE is returned, it indicates that an image file format is currently selected.

- See Also**
- "[Introduction to :SAVE Commands](#)" on page 727
 - "[:SAVE:WAVEform\[:START\]](#)" on page 748
 - "[:SAVE:WAVEform:LENGth](#)" on page 750
 - "[:SAVE:IMAGe:FORMat](#)" on page 733

:SAVE:WAVEform:LENGth

N (see [page 1384](#))

Command Syntax :SAVE:WAVEform:LENGth <length>

<length> ::= 100 to max. length; an integer in NR1 format

When the :SAVE:WAVEform:LENGth:MAX setting is OFF, the :SAVE:WAVEform:LENGth command sets the waveform data length (that is, the number of points saved).

When the :SAVE:WAVEform:LENGth:MAX setting is ON, the :SAVE:WAVEform:LENGth setting has no effect.

Query Syntax :SAVE:WAVEform:LENGth?

The :SAVE:WAVEform:LENGth? query returns the current waveform data length setting.

Return Format <length><NL>

<length> ::= 100 to max. length; an integer in NR1 format

- See Also**
- ["Introduction to :SAVE Commands"](#) on page 727
 - [":SAVE:WAVEform:LENGth:MAX"](#) on page 751
 - [":SAVE:WAVEform\[:START\]"](#) on page 748
 - [":WAVEform:POINts"](#) on page 1208
 - [":SAVE:WAVEform:FORMat"](#) on page 749

:SAVE:WAVEform:LENGth:MAX

N (see [page 1384](#))

Command Syntax :SAVE:WAVEform:LENGth:MAX <setting>

<setting> ::= {{OFF | 0} | {ON | 1}}

The :SAVE:WAVEform:LENGth:MAX command specifies whether maximum number of waveform data points is saved.

When OFF, the :SAVE:WAVEform:LENGth command specifies the number of waveform data points saved.

Query Syntax :SAVE:WAVEform:LENGth:MAX?

The :SAVE:WAVEform:LENGth:MAX? query returns the current setting.

Return Format <setting><NL>

<setting> ::= {0 | 1}

- See Also**
- ["Introduction to :SAVE Commands"](#) on page 727
 - [":SAVE:WAVEform\[:START\]"](#) on page 748
 - [":SAVE:WAVEform:LENGth"](#) on page 750

:SAVE:WAVEform:SEGmented

N (see [page 1384](#))

Command Syntax :SAVE:WAVEform:SEGmented <option>

<option> ::= {ALL | CURRent}

When segmented memory is used for acquisitions, the :SAVE:WAVEform:SEGmented command specifies which segments are included when the waveform is saved:

- ALL – all acquired segments are saved.
- CURRent – only the currently selected segment is saved.

Query Syntax :SAVE:WAVEform:SEGmented?

The :SAVE:WAVEform:SEGmented? query returns the current segmented waveform save option setting.

Return Format <option><NL>

<option> ::= {ALL | CURR}

- See Also**
- ["Introduction to :SAVE Commands"](#) on page 727
 - [":SAVE:WAVEform\[:START\]"](#) on page 748
 - [":SAVE:WAVEform:FORMat"](#) on page 749
 - [":SAVE:WAVEform:LENGth"](#) on page 750

:SAVE:WMEMemory:SOURce

N (see [page 1384](#))

Command Syntax :SAVE:WMEMemory:SOURce <source>
 <source> ::= {CHANnel<n> | FUNcTION<m> | MATH<m> | WMEMemory<r>}
 <n> ::= 1 to (# analog channels) in NR1 format
 <m> ::= 1 to (# math functions) in NR1 format
 <r> ::= 1 to (# ref waveforms) in NR1 format

The :SAVE:WMEMemory:SOURce command selects the source to be saved as a reference waveform file.

NOTE

Only ADD or SUBtract math operations can be saved as reference waveforms.

NOTE

MATH is an alias for FUNcTION. The query will return FUNC if the source is FUNcTION or MATH.

Query Syntax :SAVE:WMEMemory:SOURce?

The :SAVE:WMEMemory:SOURce? query returns the source to be saved as a reference waveform file.

Return Format <source><NL>
 <source> ::= {CHAN<n> | FUNC | WMEM<r> | NONE}

- See Also**
- ["Introduction to :SAVE Commands"](#) on page 727
 - [":SAVE:WMEMemory\[:START\]"](#) on page 754
 - [":RECall:WMEMemory<r>\[:START\]"](#) on page 724

:SAVE:WMEMemory[:START]

N (see [page 1384](#))

Command Syntax :SAVE:WMEMemory[:START] [<file_name>]
<file_name> ::= quoted ASCII string

The :SAVE:WMEMemory[:START] command saves oscilloscope waveform data to a reference waveform file.

NOTE

If a file extension is provided as part of a specified <file_name>, it must be ".h5".

-
- See Also**
- ["Introduction to :SAVE Commands"](#) on page 727
 - [":SAVE:WMEMemory:SOURce"](#) on page 753
 - [":RECall:WMEMemory<r>\[:START\]"](#) on page 724

29 :SBUS<n> Commands

Control the modes and parameters for each serial bus decode/trigger type. See:

- "[Introduction to :SBUS<n> Commands](#)" on page 755
- "[General :SBUS<n> Commands](#)" on page 757
- "[:SBUS<n>:A429 Commands](#)" on page 760
- "[:SBUS<n>:CAN Commands](#)" on page 777
- "[:SBUS<n>:CXPI Commands](#)" on page 807
- "[:SBUS<n>:FLEXray Commands](#)" on page 824
- "[:SBUS<n>:I2S Commands](#)" on page 843
- "[:SBUS<n>:IIC Commands](#)" on page 862
- "[:SBUS<n>:LIN Commands](#)" on page 872
- "[:SBUS<n>:M1553 Commands](#)" on page 890
- "[:SBUS<n>:SENT Commands](#)" on page 897
- "[:SBUS<n>:SPI Commands](#)" on page 930
- "[:SBUS<n>:UART Commands](#)" on page 946

Introduction to :SBUS<n> Commands

The :SBUS subsystem commands control the serial decode bus viewing, mode, and other options.

NOTE

These commands are only valid on oscilloscope models when a serial decode option has been licensed.

The following serial bus decode/trigger types are available (see "[:TRIGger:MODE](#)" on page 1106).

- **CAN (Controller Area Network) triggering** – will trigger on CAN version 2.0A and 2.0B signals. Setup consists of connecting the oscilloscope to a CAN signal. Baud rate, signal source, and signal polarity, and type of data to trigger on can be specified. You can trigger on CAN data and identifier patterns and you can set the bit sample point.
- **CXPI triggering** (with CXPI license) – lets you trigger on CXPI serial data.

- **I2S (Inter-IC Sound or Integrated Interchip Sound bus) triggering**— consists of connecting the oscilloscope to the serial clock, word select, and serial data lines, then triggering on a data value.
- **IIC (Inter-IC bus) triggering**— consists of connecting the oscilloscope to the serial data (SDA) line and the serial clock (SCL) line, then triggering on a stop/start condition, a restart, a missing acknowledge, or on a read/write frame with a specific device address and data value.
- **LIN (Local Interconnect Network) triggering**— will trigger on LIN sync break at the beginning of a message frame. You can trigger on Sync Break, Frame IDs, or Frame IDs and Data.
- **SPI (Serial Peripheral Interface) triggering**— consists of connecting the oscilloscope to a clock, data (MOSI or MISO), and framing signal. You can then trigger on a data pattern during a specific framing period. The serial data string can be specified to be from 4 to 64 bits long.
- **UART/RS-232 triggering** (with COMP license) — lets you trigger on RS-232 serial data.
- **SENT triggering** (with SENSOR license) — lets you trigger on SENT serial data.

NOTE

Two I2S buses or two SPI buses cannot be decoded on both SBUS1 and SBUS2 at the same time.

Reporting the Setup

Use :SBUS<n>? to query setup information for the :SBUS<n> subsystem.

Return Format

The following is a sample response from the :SBUS1? query. In this case, the query was issued following a *RST command.

```
:SBUS1:DISP 0;MODE IIC;:SBUS1:IIC:ASIZ BIT7;:SBUS1:IIC:TRIG:TYPE
STAR;QUAL EQU;:SBUS1:IIC:SOUR:CLOC CHAN1;DATA
CHAN2;:SBUS1:IIC:TRIG:PATT:ADDR -1;DATA -1;DATA2 -1
```

General :SBUS<n> Commands

Table 111 General :SBUS<n> Commands Summary

Command	Query	Options and Query Returns
:SBUS<n>:DISPlay {{0 OFF} {1 ON}} (see page 758)	:SBUS<n>:DISPlay? (see page 758)	{0 1}
:SBUS<n>:MODE <mode> (see page 759)	:SBUS<n>:MODE? (see page 759)	<mode> ::= {A429 CAN CXPI FLEXray I2S IIC LIN M1553 SENT SPI UART}

:SBUS<n>:DISPlay

N (see [page 1384](#))

Command Syntax :SBUS<n>:DISPlay <display>
 <display> ::= {{1 | ON} | {0 | OFF}}

The :SBUS<n>:DISPlay command turns displaying of the serial decode bus on or off.

NOTE

This command is only valid when a serial decode option has been licensed.

NOTE

Two I2S buses or two SPI buses cannot be decoded on both SBUS1 and SBUS2 at the same time.

Query Syntax :SBUS<n>:DISPlay?

The :SBUS<n>:DISPlay? query returns the current display setting of the serial decode bus.

Return Format <display><NL>
 <display> ::= {0 | 1}

Errors • ["-241, Hardware missing"](#) on page 1343

- See Also** • ["Introduction to :SBUS<n> Commands"](#) on page 755
- [":CHANnel<n>:DISPlay"](#) on page 294
 - [":DIGital<d>:DISPlay"](#) on page 335
 - [":POD<n>:DISPlay"](#) on page 617
 - [":VIEW"](#) on page 252
 - [":BLANK"](#) on page 224
 - [":STATus"](#) on page 249

:SBUS<n>:MODE

N (see [page 1384](#))

Command Syntax :SBUS<n>:MODE <mode>

```
1234567890123456789012345678901234567890123456789012345678901234567890
<mode> ::= {A429 | FLEXray | CAN | CXPI | I2S | IIC | LIN | M1553
            | SENT | SPI | UART}
```

The :SBUS<n>:MODE command determines the decode mode for the serial bus.

NOTE

This command is only valid when a serial decode option has been licensed.

Query Syntax :SBUS<n>:MODE?

The :SBUS<n>:MODE? query returns the current serial bus decode mode setting.

Return Format <mode><NL>

```
<mode> ::= {A429 | FLEX | CAN | CXPI | I2S | IIC | LIN | M1553 | SENT
            | SPI | UART | NONE}
```

Errors • ["-241, Hardware missing"](#) on page 1343

See Also • ["Introduction to :SBUS<n> Commands"](#) on page 755

- [":SBUS<n>:A429 Commands"](#) on page 760
- [":SBUS<n>:CAN Commands"](#) on page 777
- [":SBUS<n>:FLEXray Commands"](#) on page 824
- [":SBUS<n>:I2S Commands"](#) on page 843
- [":SBUS<n>:IIC Commands"](#) on page 862
- [":SBUS<n>:LIN Commands"](#) on page 872
- [":SBUS<n>:M1553 Commands"](#) on page 890
- [":SBUS<n>:SENT Commands"](#) on page 897
- [":SBUS<n>:SPI Commands"](#) on page 930
- [":SBUS<n>:UART Commands"](#) on page 946

:SBUS<n>:A429 Commands

NOTE

These commands are valid when the DSOX4AERO MIL-STD-1553 and ARINC 429 triggering and serial decode option (Option AERO) has been licensed.

Table 112: :SBUS<n>:A429 Commands Summary

Command	Query	Options and Query Returns
:SBUS<n>:A429:AUTOset up (see page 762)	n/a	n/a
:SBUS<n>:A429:BASE <base> (see page 763)	:SBUS<n>:A429:BASE? (see page 763)	<base> ::= {BINary HEX}
n/a	:SBUS<n>:A429:COUNT:ERRor? (see page 764)	<error_count> ::= integer in NR1 format
:SBUS<n>:A429:COUNT:RESet (see page 765)	n/a	n/a
n/a	:SBUS<n>:A429:COUNT:WORD? (see page 766)	<word_count> ::= integer in NR1 format
:SBUS<n>:A429:FORMat <format> (see page 767)	:SBUS<n>:A429:FORMat? (see page 767)	<format> ::= {LDSDi LDSSm LDATa}
:SBUS<n>:A429:SIGNal <signal> (see page 768)	:SBUS<n>:A429:SIGNal? (see page 768)	<signal> ::= {A B DIFFerential}
:SBUS<n>:A429:SOURce <source> (see page 769)	:SBUS<n>:A429:SOURce? (see page 769)	<source> ::= {CHANnel<n>} <n> ::= 1 to (# analog channels) in NR1 format
:SBUS<n>:A429:SPEed <speed> (see page 770)	:SBUS<n>:A429:SPEed? (see page 770)	<speed> ::= {LOW HIGH}
:SBUS<n>:A429:TRIGger :LABel <value> (see page 771)	:SBUS<n>:A429:TRIGger :LABel? (see page 771)	<value> ::= 8-bit integer in decimal, <hex>, <octal>, or <string> from 0-255 or "0xXX" (don't care) <hex> ::= #Hnn where n ::= {0,...,9 A,...,F} <octal> ::= #Qnnn where n ::= {0,...,7} <string> ::= "0xnn" where n ::= {0,...,9 A,...,F}

Table 112: :SBUS<n>:A429 Commands Summary (continued)

Command	Query	Options and Query Returns
:SBUS<n>:A429:TRIGger :PATtern:DATA <string> (see page 772)	:SBUS<n>:A429:TRIGger :PATtern:DATA? (see page 772)	<string> ::= "nn...n" where n ::= {0 1 X}, length depends on FORMat
:SBUS<n>:A429:TRIGger :PATtern:SDI <string> (see page 773)	:SBUS<n>:A429:TRIGger :PATtern:SDI? (see page 773)	<string> ::= "nn" where n ::= {0 1 X}, length always 2 bits
:SBUS<n>:A429:TRIGger :PATtern:SSM <string> (see page 774)	:SBUS<n>:A429:TRIGger :PATtern:SSM? (see page 774)	<string> ::= "nn" where n ::= {0 1 X}, length always 2 bits
:SBUS<n>:A429:TRIGger :RANGe <min>, <max> (see page 775)	:SBUS<n>:A429:TRIGger :RANGe? (see page 775)	<min> ::= 8-bit integer in decimal, <hex>, <octal>, or <string> from 0-255 <max> ::= 8-bit integer in decimal, <hex>, <octal>, or <string> from 0-255 <hex> ::= #Hnn where n ::= {0,...,9 A,...,F} <octal> ::= #Qnnn where n ::= {0,...,7} <string> ::= "0xnn" where n ::= {0,...,9 A,...,F}
:SBUS<n>:A429:TRIGger :TYPE <condition> (see page 776)	:SBUS<n>:A429:TRIGger :TYPE? (see page 776)	<condition> ::= {WSTArt WSTOp LABEL LBITs PERRor WERRor GERRor WGERrors ALLerrors LRange ABITs AOBits AZBits}

:SBUS<n>:A429:AUTosetup

N (see [page 1384](#))

Command Syntax :SBUS<n>:A429:AUTosetup

The :SBUS<n>:A429:AUTosetup command automatically sets these options for decoding and triggering on ARINC 429 signals:

- High Trigger Threshold: 3.0 V.
- Low Trigger Threshold: -3.0 V.
- Noise Reject: Off.
- Probe Attenuation: 10.0.
- Vertical Scale: 4 V/div.
- Serial Decode: On.
- Base (:SBUS<n>:A429:BASE): HEX.
- Word Format (:SBUS<n>:A429:FORMat): LDSDi (Label/SDI/Data/SSM).
- Trigger: the specified serial bus (n of SBUS<n>).
- Trigger Mode (:SBUS<n>:A429:TRIGger:TYPE): WSTArt.

Errors • ["-241, Hardware missing"](#) on page 1343

- See Also**
- [":SBUS<n>:A429:BASE"](#) on page 763
 - [":SBUS<n>:A429:FORMat"](#) on page 767
 - [":SBUS<n>:A429:TRIGger:TYPE"](#) on page 776
 - ["Introduction to :SBUS<n> Commands"](#) on page 755
 - [":SBUS<n>:MODE"](#) on page 759
 - [":SBUS<n>:A429 Commands"](#) on page 760

:SBUS<n>:A429:BASE

N (see [page 1384](#))

Command Syntax :SBUS<n>:A429:BASE <base>

<base> ::= {BINary | HEX}

The :SBUS<n>:A429:BASE command selects between hexadecimal and binary display of the decoded data.

The BASE command has no effect on the SDI and SSM fields, which are always displayed in binary, nor the Label field, which is always displayed in octal.

Query Syntax :SBUS<n>:A429:BASE?

The :SBUS<n>:A429:BASE? query returns the current ARINC 429 base setting.

Return Format <base><NL>

<base> ::= {BIN | HEX}

Errors • ["-241, Hardware missing"](#) on page 1343

See Also • ["Introduction to :SBUS<n> Commands"](#) on page 755

• [":SBUS<n>:MODE"](#) on page 759

• [":SBUS<n>:A429:FORMat"](#) on page 767

:SBUS<n>:A429:COUNT:ERRor

N (see [page 1384](#))

Query Syntax :SBUS<n>:A429:COUNT:ERRor?

Returns the error count.

Return Format <error_count><NL>

<error_count> ::= integer in NR1 format

Errors • ["-241, Hardware missing"](#) on page 1343

- See Also**
- [":SBUS<n>:A429:COUNT:RESet"](#) on page 765
 - [":SBUS<n>:A429:COUNT:WORD"](#) on page 766
 - ["Introduction to :SBUS<n> Commands"](#) on page 755
 - [":SBUS<n>:MODE"](#) on page 759
 - [":SBUS<n>:A429 Commands"](#) on page 760

:SBUS<n>:A429:COUNT:RESet

N (see [page 1384](#))

Command Syntax :SBUS<n>:A429:COUNT:RESet

Resets the word and error counters.

Errors · ["-241, Hardware missing"](#) on page 1343

- See Also** · [":SBUS<n>:A429:COUNT:WORD"](#) on page 766
- [":SBUS<n>:A429:COUNT:ERRor"](#) on page 764
 - ["Introduction to :SBUS<n> Commands"](#) on page 755
 - [":SBUS<n>:MODE"](#) on page 759
 - [":SBUS<n>:A429 Commands"](#) on page 760

:SBUS<n>:A429:COUNT:WORD

N (see [page 1384](#))

Query Syntax :SBUS<n>:A429:COUNT:WORD?

Returns the word count.

Return Format <word_count><NL>

<word_count> ::= integer in NR1 format

Errors • ["-241, Hardware missing"](#) on page 1343

- See Also**
- [":SBUS<n>:A429:COUNT:RESet"](#) on page 765
 - [":SBUS<n>:A429:COUNT:ERRor"](#) on page 764
 - ["Introduction to :SBUS<n> Commands"](#) on page 755
 - [":SBUS<n>:MODE"](#) on page 759
 - [":SBUS<n>:A429 Commands"](#) on page 760

:SBUS<n>:A429:FORMat

N (see [page 1384](#))

Command Syntax :SBUS<n>:A429:FORMat <format>

<format> ::= {LDSDi | LDSSm | LDATa}

The :SBUS<n>:A429:FORMat command specifies the word decode format:

- LDSDi:
 - Label - 8 bits.
 - SDI - 2 bits.
 - Data - 19 bits.
 - SSM - 2 bits.
- LDSSm:
 - Label - 8 bits.
 - Data - 21 bits.
 - SSM - 2 bits.
- LDATa:
 - Label - 8 bits.
 - Data - 23 bits.

Query Syntax :SBUS<n>:A429:FORMat?

The :SBUS<n>:A429:FORMat? query returns the current ARINC 429 word decode format setting.

Return Format <format><NL>

<format> ::= {LDSD | LDSS | LDAT}

Errors • ["-241, Hardware missing"](#) on page 1343

- See Also**
- ["Introduction to :SBUS<n> Commands"](#) on page 755
 - [":SBUS<n>:MODE"](#) on page 759
 - [":SBUS<n>:A429:TRIGger:PATtern:DATA"](#) on page 772
 - [":SBUS<n>:A429:TRIGger:PATtern:SDI"](#) on page 773
 - [":SBUS<n>:A429:TRIGger:PATtern:SSM"](#) on page 774
 - [":SBUS<n>:A429:TRIGger:TYPE"](#) on page 776
 - [":SBUS<n>:A429:SIGNal"](#) on page 768
 - [":SBUS<n>:A429:SPEed"](#) on page 770
 - [":SBUS<n>:A429:BASE"](#) on page 763
 - [":SBUS<n>:A429:SOURce"](#) on page 769

:SBUS<n>:A429:SIGNal

N (see [page 1384](#))

Command Syntax :SBUS<n>:A429:SIGNal <signal>
 <signal> ::= {A | B | DIFFerential}

The :SBUS<n>:A429:SIGNal command specifies the signal type:

- A – Line A (non-inverted).
- B – Line B (inverted).
- DIFFerential – Differential (A-B).

Query Syntax :SBUS<n>:A429:SIGNal?

The :SBUS<n>:A429:SIGNal? query returns the current ARINC 429 signal type setting.

Return Format <signal><NL>
 <signal> ::= {A | B | DIFF}

Errors • ["-241, Hardware missing"](#) on page 1343

See Also • ["Introduction to :SBUS<n> Commands"](#) on page 755

- [":SBUS<n>:MODE"](#) on page 759
- [":SBUS<n>:A429:FORMat"](#) on page 767
- [":SBUS<n>:A429:SPEed"](#) on page 770
- [":SBUS<n>:A429:SOURce"](#) on page 769

:SBUS<n>:A429:SOURce

N (see [page 1384](#))

Command Syntax :SBUS<n>:A429:SOURce <source>

<source> ::= {CHANnel<n>}

<n> ::= 1 to (# analog channels) in NR1 format

The :SBUS<n>:A429:SOURce command sets the source of the ARINC 429 signal.

Query Syntax :SBUS<n>:A429:SOURce?

The :SBUS<n>:A429:SOURce? query returns the currently set source of the ARINC 429 signal.

Use the :TRIGger:LEVel:HIGH and :TRIGger:LEVel:LOW commands to set the threshold levels for the selected source.

Return Format <source><NL>

- See Also**
- [":TRIGger:LEVel:HIGH"](#) on page 1104
 - [":TRIGger:LEVel:LOW"](#) on page 1105
 - [":TRIGger:MODE"](#) on page 1106
 - [":SBUS<n>:MODE"](#) on page 759
 - [":SBUS<n>:A429:TRIGger:TYPE"](#) on page 776
 - [":SBUS<n>:A429:SIGNaL"](#) on page 768
 - [":SBUS<n>:A429:SPEEd"](#) on page 770
 - [":SBUS<n>:A429:FORMat"](#) on page 767
 - ["Introduction to :TRIGger Commands"](#) on page 1097

:SBUS<n>:A429:SPeEd

N (see [page 1384](#))

Command Syntax :SBUS<n>:A429:SPeEd <speed>

<speed> ::= {LOW | HIGH}

The :SBUS<n>:A429:SPeEd command specifies the signal speed:

- LOW – 12.5 kb/s.
- HIGH – 100 kb/s.

Query Syntax :SBUS<n>:A429:SPeEd?

The :SBUS<n>:A429:SPeEd? query returns the current ARINC 429 signal speed setting.

Return Format <speed><NL>

<speed> ::= {LOW | HIGH}

Errors • ["-241, Hardware missing"](#) on page 1343

See Also • ["Introduction to :SBUS<n> Commands"](#) on page 755

- [":SBUS<n>:MODE"](#) on page 759
- [":SBUS<n>:A429:SIGNal"](#) on page 768
- [":SBUS<n>:A429:FORMat"](#) on page 767
- [":SBUS<n>:A429:SOURce"](#) on page 769

:SBUS<n>:A429:TRIGger:LABel

N (see [page 1384](#))

Command Syntax :SBUS<n>:A429:TRIGger:LABel <value>

<value> ::= 8-bit integer in decimal, <hex>, <octal>, or <string>
from 0-255 or "0xXX" (don't care)

<hex> ::= #Hnn where n ::= {0,...,9 | A,...,F}

<octal> ::= #Qnnn where n ::= {0,...,7}

<string> ::= "0xnn" where n ::= {0,...,9 | A,...,F}

The :SBUS<n>:A429:TRIGger:LABel command defines the ARINC 429 label value when labels are used in the selected trigger type.

To set the label value to don't cares (0xXX), set the value to -1.

Query Syntax :SBUS<n>:A429:TRIGger:LABel?

The :SBUS<n>:A429:TRIGger:LABel? query returns the current label value in decimal format.

Return Format <value><NL> in decimal format

Errors · ["-241, Hardware missing"](#) on page 1343

See Also · ["Introduction to :TRIGger Commands"](#) on page 1097

· [":SBUS<n>:A429:TRIGger:TYPE"](#) on page 776

:SBUS<n>:A429:TRIGger:PATtern:DATA

N (see [page 1384](#))

Command Syntax :SBUS<n>:A429:TRIGger:PATtern:DATA <string>

<string> ::= "nn...n" where n ::= {0 | 1 | X}, length depends on FORMat

The :SBUS<n>:A429:TRIGger:PATtern:DATA command defines the ARINC 429 data pattern resource according to the string parameter. This pattern controls the data pattern searched for in each ARINC 429 word.

NOTE

If more bits are sent for <string> than specified by the :SBUS<n>:A429:FORMat command, the most significant bits will be truncated.

Query Syntax :SBUS<n>:A429:TRIGger:PATtern:DATA?

The :SBUS<n>:A429:TRIGger:PATtern:DATA? query returns the current settings of the specified ARINC 429 data pattern resource in the binary string format.

Return Format <string><NL> in nondecimal format

Errors · ["-241, Hardware missing"](#) on page 1343

See Also · ["Introduction to :TRIGger Commands"](#) on page 1097
 · [":SBUS<n>:A429:TRIGger:TYPE"](#) on page 776
 · [":SBUS<n>:A429:TRIGger:PATtern:SDI"](#) on page 773
 · [":SBUS<n>:A429:TRIGger:PATtern:SSM"](#) on page 774

:SBUS<n>:A429:TRIGger:PATtern:SDI

N (see [page 1384](#))

Command Syntax :SBUS<n>:A429:TRIGger:PATtern:SDI <string>

<string> ::= "nn" where n ::= {0 | 1 | X}, length always 2 bits

The :SBUS<n>:A429:TRIGger:PATtern:SDI command defines the ARINC 429 two-bit SDI pattern resource according to the string parameter. This pattern controls the SDI pattern searched for in each ARINC 429 word.

The specified SDI is only used if the :SBUS<n>:A429:FORMat includes the SDI field.

Query Syntax :SBUS<n>:A429:TRIGger:PATtern:SDI?

The :SBUS<n>:A429:TRIGger:PATtern:SDI? query returns the current settings of the specified ARINC 429 two-bit SDI pattern resource in the binary string format.

Return Format <string><NL> in nondecimal format

Errors · ["-241, Hardware missing"](#) on page 1343

- See Also** · ["Introduction to :TRIGger Commands"](#) on page 1097
- [":SBUS<n>:A429:FORMat"](#) on page 767
 - [":SBUS<n>:A429:TRIGger:TYPE"](#) on page 776
 - [":SBUS<n>:A429:TRIGger:PATtern:DATA"](#) on page 772
 - [":SBUS<n>:A429:TRIGger:PATtern:SSM"](#) on page 774

:SBUS<n>:A429:TRIGger:PATtern:SSM

N (see [page 1384](#))

Command Syntax :SBUS<n>:A429:TRIGger:PATtern:SSM <string>

<string> ::= "nn" where n ::= {0 | 1 | X}, length always 2 bits

The :SBUS<n>:A429:TRIGger:PATtern:SSM command defines the ARINC 429 two-bit SSM pattern resource according to the string parameter. This pattern controls the SSM pattern searched for in each ARINC 429 word.

The specified SSM is only used if the :SBUS<n>:A429:FORMat includes the SSM field.

Query Syntax :SBUS<n>:A429:TRIGger:PATtern:SSM?

The :SBUS<n>:A429:TRIGger:PATtern:SSM? query returns the current settings of the specified ARINC 429 two-bit SSM pattern resource in the binary string format.

Return Format <string><NL> in nondecimal format

Errors · ["-241, Hardware missing"](#) on page 1343

- See Also** · ["Introduction to :TRIGger Commands"](#) on page 1097
- [":SBUS<n>:A429:FORMat"](#) on page 767
 - [":SBUS<n>:A429:TRIGger:TYPE"](#) on page 776
 - [":SBUS<n>:A429:TRIGger:PATtern:DATA"](#) on page 772
 - [":SBUS<n>:A429:TRIGger:PATtern:SDI"](#) on page 773

:SBUS<n>:A429:TRIGger:RANGe

N (see [page 1384](#))

Command Syntax :SBUS<n>:A429:TRIGger:RANGe <min>,<max>

<min> ::= 8-bit integer in decimal, <hex>, <octal>, or <string>
from 0-255

<max> ::= 8-bit integer in decimal, <hex>, <octal>, or <string>
from 0-255

<hex> ::= #Hnn where n ::= {0,...,9 | A,...,F}

<octal> ::= #Qnnn where n ::= {0,...,7}

<string> ::= "0xnn" where n ::= {0,...,9 | A,...,F}

The :SBUS<n>:A429:TRIGger:RANGe command defines a range of ARINC 429 label values. This range is used when the LRANGe trigger type is selected.

Query Syntax :SBUS<n>:A429:TRIGger:RANGe?

The :SBUS<n>:A429:TRIGger:RANGe? query returns the current label values in decimal format.

Return Format <min>,<max><NL> in decimal format

Errors · ["-241, Hardware missing"](#) on page 1343

See Also · ["Introduction to :TRIGger Commands"](#) on page 1097

· [":SBUS<n>:A429:TRIGger:TYPE"](#) on page 776

:SBUS<n>:A429:TRIGger:TYPE

N (see [page 1384](#))

Command Syntax :SBUS<n>:A429:TRIGger:TYPE <condition>

```
<condition> ::= {WStArt | WStOp | LABel | LBITs | PERRor | WERRor
                 | GERRor | WGERrors | ALLerrors | LRANge | ABITs
                 | AOBits | AZBits}
```

The :SBUS<n>:A429:TRIGger command sets the ARINC 429 trigger on condition:

- WStArt – triggers on the start of a word.
- WStOp – triggers at the end of a word.
- LABel – triggers on the specified label value.
- LBITs – triggers on the label and the other word fields as specified.
- LRANge – triggers on a label within a min/max range.
- PERRor – triggers on words with a parity error.
- WERRor – triggers on an intra-word coding error.
- GERRor – triggers on an inter-word gap error.
- WGERrors – triggers on either a Word or Gap Error.
- ALLerrors – triggers on any of the above errors.
- ABITs – triggers on any bit, which will therefore form an eye diagram.
- AZBits – triggers on any bit with a value of zero.
- AOBits – triggers on any bit with a value of one.

Query Syntax :SBUS<n>:A429:TRIGger:TYPE?

The :SBUS<n>:A429:TRIGger:TYPE? query returns the current ARINC 429 trigger on condition.

Return Format <condition><NL>

```
<condition> ::= {WSTA | WSTO | LAB | LBIT | PERR | WERR | GERR | WGER
                 | ALL | LRAN | ABIT | AOB | AZB}
```

Errors • **"-241, Hardware missing"** on page 1343

- See Also**
- **"Introduction to :SBUS<n> Commands"** on page 755
 - **":SBUS<n>:MODE"** on page 759
 - **":SBUS<n>:A429:TRIGger:LABel"** on page 771
 - **":SBUS<n>:A429:TRIGger:PATtern:DATA"** on page 772
 - **":SBUS<n>:A429:TRIGger:PATtern:SDI"** on page 773
 - **":SBUS<n>:A429:TRIGger:PATtern:SSM"** on page 774
 - **":SBUS<n>:A429:TRIGger:RANge"** on page 775
 - **":SBUS<n>:A429:SOURce"** on page 769

:SBUS<n>:CAN Commands

NOTE

These commands are valid when the automotive CAN and LIN serial decode option (Option AMS) has been licensed.

Table 113: :SBUS<n>:CAN Commands Summary

Command	Query	Options and Query Returns
n/a	:SBUS<n>:CAN:COUNT:ERror? (see page 780)	<frame_count> ::= integer in NR1 format
n/a	:SBUS<n>:CAN:COUNT:OVERload? (see page 781)	<frame_count> ::= 0 in NR1 format
:SBUS<n>:CAN:COUNT:RESet (see page 782)	n/a	n/a
n/a	:SBUS<n>:CAN:COUNT:SPECerror? (see page 783)	<spec_error_count> ::= integer in NR1 format
n/a	:SBUS<n>:CAN:COUNT:TOTAL? (see page 784)	<frame_count> ::= integer in NR1 format
n/a	:SBUS<n>:CAN:COUNT:UTILization? (see page 785)	<percent> ::= floating-point in NR3 format
:SBUS<n>:CAN:DISPLAY<type> (see page 786)	:SBUS<n>:CAN:DISPLAY? (see page 786)	<type> ::= {HEXadecimal SYMBOLic}
:SBUS<n>:CAN:FDSPoint<value> (see page 787)	:SBUS<n>:CAN:FDSPoint? (see page 787)	<value> ::= even numbered percentages from 30 to 90 in NR3 format.
:SBUS<n>:CAN:FDSTandard<std> (see page 788)	:SBUS<n>:CAN:FDSTandard? (see page 788)	<std> ::= {ISO NISO}
:SBUS<n>:CAN:SAMPLEpoint<percent> (see page 789)	:SBUS<n>:CAN:SAMPLEpoint? (see page 789)	<percent> ::= 30.0 to 90.0 in NR3 format
:SBUS<n>:CAN:SIGNAL:BAUDrate<baudrate> (see page 790)	:SBUS<n>:CAN:SIGNAL:BAUDrate? (see page 790)	<baudrate> ::= integer from 10000 to 4000000 in 100 b/s increments, or 5000000
:SBUS<n>:CAN:SIGNAL:DEFinition<value> (see page 791)	:SBUS<n>:CAN:SIGNAL:DEFinition? (see page 791)	<value> ::= {CANH CANL RX TX DIFFerential DIFL DIFH}
:SBUS<n>:CAN:SIGNAL:FDbaudrate<baudrate> (see page 792)	:SBUS<n>:CAN:SIGNAL:FDbaudrate? (see page 792)	<baudrate> ::= integer from 10000 to 10000000 in 100 b/s increments.

Table 113: :SBUS<n>:CAN Commands Summary (continued)

Command	Query	Options and Query Returns
:SBUS<n>:CAN:SOURce <source> (see page 793)	:SBUS<n>:CAN:SOURce? (see page 793)	<source> ::= {CHANnel<n> EXTernal} for DSO models <source> ::= {CHANnel<n> DIGital<d> } for MSO models <n> ::= 1 to (# analog channels) in NR1 format <d> ::= 0 to (# digital channels - 1) in NR1 format
:SBUS<n>:CAN:TRIGger <condition> (see page 794)	:SBUS<n>:CAN:TRIGger? (see page 795)	<condition> ::= {SOF EOF IDData DATA FDData IDRemote IDEither ERRor ACKerror FORMerror STUFFerror CRCerror SPECerror ALLerrors BRsBit CRCDbit EBActive EBPAssive OVERload MESSage MSIGnal FDMSignal}
:SBUS<n>:CAN:TRIGger:IDFilter {{0 OFF} {1 ON}} (see page 797)	:SBUS<n>:CAN:TRIGger:IDFilter? (see page 797)	{0 1}
:SBUS<n>:CAN:TRIGger:PATtern:DATA <string> (see page 798)	:SBUS<n>:CAN:TRIGger:PATtern:DATA? (see page 798)	<string> ::= "nn...n" where n ::= {0 1 X \$} <string ::= "0xnn...n" where n ::= {0,...,9 A,...,F X \$}
:SBUS<n>:CAN:TRIGger:PATtern:DATA:DLC <dlc> (see page 799)	:SBUS<n>:CAN:TRIGger:PATtern:DATA:DLC? (see page 799)	<dlc> ::= integer between -1 (don't care) and 64, in NR1 format.
:SBUS<n>:CAN:TRIGger:PATtern:DATA:LENGth <length> (see page 800)	:SBUS<n>:CAN:TRIGger:PATtern:DATA:LENGth? (see page 800)	<length> ::= integer from 1 to 8 in NR1 format
:SBUS<n>:CAN:TRIGger:PATtern:DATA:STARt <start> (see page 801)	:SBUS<n>:CAN:TRIGger:PATtern:DATA:STARt? (see page 801)	<start> ::= integer between 0 and 63, in NR1 format.
:SBUS<n>:CAN:TRIGger:PATtern:ID <string> (see page 802)	:SBUS<n>:CAN:TRIGger:PATtern:ID? (see page 802)	<string> ::= "nn...n" where n ::= {0 1 X \$} <string ::= "0xnn...n" where n ::= {0,...,9 A,...,F X \$}
:SBUS<n>:CAN:TRIGger:PATtern:ID:MODE <value> (see page 803)	:SBUS<n>:CAN:TRIGger:PATtern:ID:MODE? (see page 803)	<value> ::= {STANdard EXTended}

Table 113: :SBUS<n>:CAN Commands Summary (continued)

Command	Query	Options and Query Returns
:SBUS<n>:CAN:TRIGger: SYMBOLic:MESSAge <name> (see page 804)	:SBUS<n>:CAN:TRIGger: SYMBOLic:MESSAge? (see page 804)	<name> ::= quoted ASCII string
:SBUS<n>:CAN:TRIGger: SYMBOLic:SIGNAL <name> (see page 805)	:SBUS<n>:CAN:TRIGger: SYMBOLic:SIGNAL? (see page 805)	<name> ::= quoted ASCII string
:SBUS<n>:CAN:TRIGger: SYMBOLic:VALue <data> (see page 806)	:SBUS<n>:CAN:TRIGger: SYMBOLic:VALue? (see page 806)	<data> ::= value in NR3 format

:SBUS<n>:CAN:COUNT:ERRor

N (see [page 1384](#))

Query Syntax :SBUS<n>:CAN:COUNT:ERRor?

Returns the error frame count.

Return Format <frame_count><NL>

<frame_count> ::= integer in NR1 format

Errors • ["-241, Hardware missing"](#) on page 1343

- See Also**
- [":SBUS<n>:CAN:COUNT:RESet"](#) on page 782
 - ["Introduction to :SBUS<n> Commands"](#) on page 755
 - [":SBUS<n>:MODE"](#) on page 759
 - [":SBUS<n>:CAN Commands"](#) on page 777

:SBUS<n>:CAN:COUNT:OVERload

N (see [page 1384](#))

Query Syntax :SBUS<n>:CAN:COUNT:OVERload?

Returns the overload frame count.

Return Format <frame_count><NL>

<frame_count> ::= 0 in NR1 format

Errors • ["-241, Hardware missing"](#) on page 1343

- See Also**
- [":SBUS<n>:CAN:COUNT:RESet"](#) on page 782
 - ["Introduction to :SBUS<n> Commands"](#) on page 755
 - [":SBUS<n>:MODE"](#) on page 759
 - [":SBUS<n>:CAN Commands"](#) on page 777

:SBUS<n>:CAN:COUNT:RESet

N (see [page 1384](#))

Command Syntax :SBUS<n>:CAN:COUNT:RESet

Resets the frame counters.

- Errors**
- ["-241, Hardware missing"](#) on page 1343
- See Also**
- [":SBUS<n>:CAN:COUNT:ERRor"](#) on page 780
 - [":SBUS<n>:CAN:COUNT:OVERload"](#) on page 781
 - [":SBUS<n>:CAN:COUNT:TOTal"](#) on page 784
 - [":SBUS<n>:CAN:COUNT:UTILization"](#) on page 785
 - ["Introduction to :SBUS<n> Commands"](#) on page 755
 - [":SBUS<n>:MODE"](#) on page 759
 - [":SBUS<n>:CAN Commands"](#) on page 777

:SBUS<n>:CAN:COUNT:SPEC

N (see [page 1384](#))

Query Syntax :SBUS<n>:CAN:COUNT:SPEC?

Returns the Spec error (Ack + Form + Stuff + CRC errors) count.

Return Format <spec_error_count><NL>

<spec_error_count> ::= integer in NR1 format

Errors • ["-241, Hardware missing"](#) on page 1343

- See Also**
- [":SBUS<n>:CAN:COUNT:RESet"](#) on page 782
 - ["Introduction to :SBUS<n> Commands"](#) on page 755
 - [":SBUS<n>:MODE"](#) on page 759
 - [":SBUS<n>:CAN Commands"](#) on page 777

:SBUS<n>:CAN:COUNT:TOTAL

N (see [page 1384](#))

Query Syntax :SBUS<n>:CAN:COUNT:TOTAL?

Returns the total frame count.

Return Format <frame_count><NL>

<frame_count> ::= integer in NR1 format

Errors • ["-241, Hardware missing"](#) on page 1343

- See Also**
- [":SBUS<n>:CAN:COUNT:RESet"](#) on page 782
 - ["Introduction to :SBUS<n> Commands"](#) on page 755
 - [":SBUS<n>:MODE"](#) on page 759
 - [":SBUS<n>:CAN Commands"](#) on page 777

:SBUS<n>:CAN:COUNT:UTILization

N (see [page 1384](#))

Query Syntax :SBUS<n>:CAN:COUNT:UTILization?

Returns the percent utilization.

Return Format <percent><NL>

<percent> ::= floating-point in NR3 format

Errors • ["-241, Hardware missing"](#) on page 1343

- See Also**
- [":SBUS<n>:CAN:COUNT:RESet"](#) on page 782
 - ["Introduction to :SBUS<n> Commands"](#) on page 755
 - [":SBUS<n>:MODE"](#) on page 759
 - [":SBUS<n>:CAN Commands"](#) on page 777

:SBUS<n>:CAN:DISPlay

N (see [page 1384](#))

Command Syntax :SBUS<n>:CAN:DISPlay <type>

<type> ::= {HEXadecimal | SYMBolic}

The :SBUS<n>:CAN:DISPlay command specifies, when CAN symbolic data is loaded into the oscilloscope, whether symbolic values (from the DBC file) or hexadecimal values are displayed in the decode waveform and the Lister window.

Query Syntax :SBUS<n>:CAN:DISPlay?

The :SBUS<n>:CAN:DISPlay? query returns the CAN decode display type.

Return Format <type><NL>

<type> ::= {HEX | SYMB}

See Also • [":RECall:DBC\[:START\]"](#) on page 718

:SBUS<n>:CAN:FDSPoint

N (see [page 1384](#))

Command Syntax :SBUS<n>:CAN:FDSPoint <value>

<value> ::= even numbered percentages from 30 to 90 in NR3 format.

The :SBUS<n>:CAN:FDSPoint command sets the point during the bit time where the bit level is sampled to determine whether the bit is dominant or recessive. The sample point represents the percentage of time between the beginning of the bit time to the end of the bit time.

Query Syntax :SBUS<n>:CAN:FDSPoint?

The :SBUS<n>:CAN:FDSPoint? query returns the current CAN FD sample point setting.

Return Format <value><NL>

<value> ::= even numbered percentages from 30 to 90 in NR3 format.

See Also • [":SBUS<n>:CAN:SIGNal:FDbaudrate"](#) on page 792

:SBUS<n>:CAN:FDStandard

N (see [page 1384](#))

Command Syntax :SBUS<n>:CAN:FDStandard <std>
 <std> ::= {ISO | NISO}

The :SBUS<n>:CAN:FDStandard command lets you pick the standard that will be used when decoding or triggering on FD frames, ISO, or non-ISO.

This setting has no effect on the processing of non-FD (classical) frames.

Query Syntax :SBUS<n>:CAN:FDStandard?

The :SBUS<n>:CAN:FDStandard? query returns the selected CAN FD frame decode standard.

Return Format <std><NL>
 <std> ::= {ISO | NISO}

See Also • [":SBUS<n>:CAN:FDSPoint"](#) on page 787

:SBUS<n>:CAN:SAMPlEpoint

N (see [page 1384](#))

Command Syntax :SBUS<n>:CAN:SAMPlEpoint <percent>
<percent><NL>

<percent> ::= 30.0 to 90.0 in NR3 format

The :SBUS<n>:CAN:SAMPlEpoint command sets the point during the bit time where the bit level is sampled to determine whether the bit is dominant or recessive. The sample point represents the percentage of time between the beginning of the bit time to the end of the bit time.

Query Syntax :SBUS<n>:CAN:SAMPlEpoint?

The :SBUS<n>:CAN:SAMPlEpoint? query returns the current CAN sample point setting.

Return Format <percent><NL>

<percent> ::= 30.0 to 90.0 in NR3 format

- See Also**
- ["Introduction to :TRIGger Commands"](#) on page 1097
 - [":SBUS<n>:MODE"](#) on page 759
 - [":SBUS<n>:CAN:TRIGger"](#) on page 794

:SBUS<n>:CAN:SIGNal:BAUDrate

N (see [page 1384](#))

Command Syntax :SBUS<n>:CAN:SIGNal:BAUDrate <baudrate>

<baudrate> ::= integer from 10000 to 4000000 in 100 b/s increments,
or 5000000

The :SBUS<n>:CAN:SIGNal:BAUDrate command sets the standard baud rate of the CAN signal from 10 kb/s to 4 Mb/s in 100 b/s increments. If you enter a baud rate that is not divisible by 100 b/s, the baud rate is set to the nearest baud rate divisible by 100 b/s.

You can also set the baud rate of the CAN signal to 5 Mb/s. Fractional baud rates between 4 Mb/s and 5 Mb/s are not allowed.

If the baud rate you select does not match the system baud rate, false triggers may occur.

Query Syntax :SBUS<n>:CAN:SIGNal:BAUDrate?

The :SBUS<n>:CAN:SIGNal:BAUDrate? query returns the current CAN baud rate setting.

Return Format <baudrate><NL>

<baudrate> ::= integer from 10000 to 4000000 in 100 b/s increments,
or 5000000

- See Also**
- ["Introduction to :TRIGger Commands"](#) on page 1097
 - [":SBUS<n>:MODE"](#) on page 759
 - [":SBUS<n>:CAN:TRIGger"](#) on page 794
 - [":SBUS<n>:CAN:SIGNal:DEFinition"](#) on page 791
 - [":SBUS<n>:CAN:SOURce"](#) on page 793

:SBUS<n>:CAN:SIGNal:DEFinition

N (see [page 1384](#))

Command Syntax :SBUS<n>:CAN:SIGNal:DEFinition <value>

<value> ::= {CANH | CANL | RX | TX | DIFFerential | DIFL | DIFH}

The :SBUS<n>:CAN:SIGNal:DEFinition command sets the CAN signal type when :SBUS<n>:CAN:TRIGger is set to SOF (start of frame). These signals can be set to:

Dominant high signals:

- CANH – the actual CAN_H differential bus signal.
- DIFH – the CAN differential (H-L) bus signal connected to an analog source channel using a differential probe.

Dominant low signals:

- CANL – the actual CAN_L differential bus signal.
- RX – the Receive signal from the CAN bus transceiver.
- TX – the Transmit signal to the CAN bus transceiver.
- DIFL – the CAN differential (L-H) bus signal connected to an analog source channel using a differential probe.
- DIFFerential – the CAN differential bus signal connected to an analog source channel using a differential probe. This is the same as DIFL.

Query Syntax :SBUS<n>:CAN:SIGNal:DEFinition?

The :SBUS<n>:CAN:SIGNal:DEFinition? query returns the current CAN signal type.

Return Format <value><NL>

<value> ::= {CANH | CANL | RX | TX | DIFL | DIFH}

- See Also**
- ["Introduction to :TRIGger Commands"](#) on page 1097
 - [":SBUS<n>:MODE"](#) on page 759
 - [":SBUS<n>:CAN:SIGNal:BAUDrate"](#) on page 790
 - [":SBUS<n>:CAN:SOURce"](#) on page 793
 - [":SBUS<n>:CAN:TRIGger"](#) on page 794

:SBUS<n>:CAN:SIGNal:FDBaudrate

N (see [page 1384](#))

Command Syntax :SBUS<n>:CAN:SIGNal:FDBaudrate <baudrate>

<baudrate> ::= integer from 10000 to 10000000 in 100 b/s increments.

The :SBUS<n>:CAN:SIGNal:FDBaudrate command sets the CAN FD baud rate from 10 kb/s to 10 Mb/s in 100 b/s increments. If you enter a baud rate that is not divisible by 100 b/s, the baud rate is set to the nearest baud rate divisible by 100 b/s.

For CAN FD, both the standard rate settings (see :SBUS<n>:CAN:SIGNal:BAUDrate) and the FD rate settings must be set correctly; otherwise, false triggers may occur.

Query Syntax :SBUS<n>:CAN:SIGNal:FDBaudrate?

The :SBUS<n>:CAN:SIGNal:FDBaudrate? query returns the current CAN FD baud rate setting.

Return Format <baudrate><NL>

<baudrate> ::= integer from 10000 to 10000000 in 100 b/s increments.

- See Also**
- [":SBUS<n>:CAN:FDSPoint"](#) on page 787
 - [":SBUS<n>:CAN:SIGNal:BAUDrate"](#) on page 790

:SBUS<n>:CAN:SOURce

N (see [page 1384](#))

Command Syntax :SBUS<n>:CAN:SOURce <source>

<source> ::= {CHANnel<n> | EXternal} for the DSO models

<source> ::= {CHANnel<n> | DIGital<d>} for the MSO models

<n> ::= 1 to (# analog channels) in NR1 format

<d> ::= 0 to (# digital channels - 1) in NR1 format

The :SBUS<n>:CAN:SOURce command sets the source for the CAN signal.

Query Syntax :SBUS<n>:CAN:SOURce?

The :SBUS<n>:CAN:SOURce? query returns the current source for the CAN signal.

Return Format <source><NL>

- See Also**
- ["Introduction to :TRIGger Commands"](#) on page 1097
 - [":SBUS<n>:MODE"](#) on page 759
 - [":SBUS<n>:CAN:TRIGger"](#) on page 794
 - [":SBUS<n>:CAN:SIGNAL:DEFinition"](#) on page 791

:SBUS<n>:CAN:TRIGger

N (see [page 1384](#))

Command Syntax :SBUS<n>:CAN:TRIGger <condition>

```
<condition> ::= {SOF | EOF | IDData | DATA | FDData | IDRemote
| IDEither | ERRor | ACKerror | FORMerror | STUFFerror | CRCerror
| SPECerror | ALLerrors | BRsBit | CRCDbit | EBActive | EBPassive
| OVERload | MESSage | MSIGnal | FDMSignal}
```

The :SBUS<n>:CAN:TRIGger command sets the CAN trigger on condition:

Condition	Front-panel name	Description	Filter by ID*
SOF	SOF - Start of Frame	Triggers at the start bit for both data and overload frames.	
EOF	EOF - End of Frame	Triggers at the end of any frame.	X
IDEither	Frame ID	Triggers on any standard CAN (data or remote) or CAN FD frame at the end of the 11- or 29-bit ID field.	
IDData	Data Frame ID (non-FD)	Triggers on standard CAN data frames at the end of the 11- or 29-bit ID field.	
DATA	Data Frame ID and Data (non-FD)	Triggers on any standard CAN data frame at the end of the last data byte defined in the trigger. The DLC of the packet must match the number of bytes specified.	
FDData	Data Frame ID and Data (FD)	triggers on CAN FD frames at the end of the last data byte defined in the trigger. You can trigger on up to 8 bytes of data anywhere within the CAN FD data, which can be up to 64 bytes long.	
IDRemote	Remote Frame ID	Triggers on standard CAN remote frames at the end of the 11- or 29-bit ID field.	
ERRor	Error Frame	Triggers after 6 consecutive 0s while in a data frame, at the EOF.	X
ACKerror	Acknowledge Error	Triggers on the acknowledge bit if the polarity is incorrect.	X
FORMerror	Form Error	Triggers on reserved bit errors.	X
STUFFerror	Stuff Error	Triggers on 6 consecutive 1s or 6 consecutive 0s, while in a non-error or non overload frame.	X

Condition	Front-panel name	Description	Filter by ID*
CRCError	CRC Field Error	Triggers when the calculated CRC does not match the transmitted CRC. In addition, for FD frames, will also trigger if the Stuff Count is in error.	X
SPECError	Spec Error (Ack or Form or Stuff or CRC)	Triggers on Ack, Form, Stuff, or CRC errors.	X
ALLerrors	All Errors	Triggers on all Spec errors and error frames.	X
BRSBit	BRS Bit (FD)	Triggers on the BRS bit of CAN FD frames.	X
CRCDbit	CRC Delimiter Bit (FD)	Triggers on the CRC delimiter bit in CAN FD frames.	X
EBAActive	ESI Bit Active (FD)	Triggers on the ESI bit if set active.	X
EBPassive	ESI Bit Passive (FD)	Triggers on the ESI bit if set passive.	X
OVERload	Overload Frame	Triggers on an overload frame.	
MESSage	Message	Triggers on a symbolic message.	
MSIGnal	Message and Signal (non-FD)	Triggers on a symbolic message and a signal value.	
FDMSignal	Message and Signal (FD, first 8 bytes only)	Triggers on a symbolic message and a signal value, limited to the first 8 bytes of FD data.	
* Filtering by CAN IDs is available for these trigger conditions (see :SBUS<n>:CAN:TRIGger:IDFilter).			

CAN Id specification is set by the :SBUS<n>:CAN:TRIGger:PATtern:ID and :SBUS<n>:CAN:TRIGger:PATtern:ID:MODE commands.

CAN Data specification is set by the :SBUS<n>:CAN:TRIGger:PATtern:DATA command.

CAN Data Length Code is set by the :SBUS<n>:CAN:TRIGger:PATtern:DATA:LENGth command.

Query Syntax :SBUS<n>:CAN:TRIGger?

The :SBUS<n>:CAN:TRIGger? query returns the current CAN trigger on condition.

Return Format <condition><NL>

```
<condition> ::= {SOF | EOF | IDD | DATA | FDD | IDR | IDE | ERR | ACK
  | FORM | STUF | CRC | SPEC | ALL | BR SB | CR CD | EBA | EBP | OVER
  | MESS | MSIG | FDMS}
```

Errors • **"-241, Hardware missing"** on page 1343

See Also • **"Introduction to :SBUS<n> Commands"** on page 755

- **":SBUS<n>:MODE"** on page 759
- **":SBUS<n>:CAN:TRIGger:PATtern:DATA"** on page 798
- **":SBUS<n>:CAN:TRIGger:PATtern:DATA:LENGth"** on page 800
- **":SBUS<n>:CAN:TRIGger:PATtern:ID"** on page 802
- **":SBUS<n>:CAN:TRIGger:PATtern:ID:MODE"** on page 803
- **":SBUS<n>:CAN:TRIGger:IDFilter"** on page 797
- **":SBUS<n>:CAN:SIGnal:DEFinition"** on page 791
- **":SBUS<n>:CAN:SOURce"** on page 793
- **":RECall:DBC[:STARt]"** on page 718
- **":SBUS<n>:CAN:TRIGger:SYMBolic:MESSage"** on page 804
- **":SBUS<n>:CAN:TRIGger:SYMBolic:SIGnal"** on page 805
- **":SBUS<n>:CAN:TRIGger:SYMBolic:VALue"** on page 806

:SBUS<n>:CAN:TRIGger:IDFilter

N (see [page 1384](#))

Command Syntax :SBUS<n>:CAN:TRIGger:IDFilter {{0 | OFF} | {1 | ON}}

The :SBUS<n>:CAN:TRIGger:IDFilter command specifies, in certain error and bit trigger modes, whether triggers are filtered by CAN IDs.

Query Syntax :SBUS<n>:CAN:TRIGger:IDFilter?

The :SBUS<n>:CAN:TRIGger:IDFilter? query returns the CAN trigger ID filter setting.

Return Format <setting><NL>

<setting> ::= {0 | 1}

See Also • [":SBUS<n>:CAN:TRIGger"](#) on page 794

:SBUS<n>:CAN:TRIGger:PATtern:DATA

N (see [page 1384](#))

Command Syntax :SBUS<n>:CAN:TRIGger:PATtern:DATA <string>

<string> ::= "nn...n" where n ::= {0 | 1 | X | \$}

<string ::= "0xnn...n" where n ::= {0,...,9 | A,...,F | X | \$}

The :SBUS<n>:CAN:TRIGger:PATtern:DATA command defines the CAN data pattern resource according to the string parameter. This pattern, along with the data length (set by the :SBUS<n>:CAN:TRIGger:PATtern:DATA:LENGth command), control the data pattern searched for in each CAN message.

If the string parameter starts with "0x", it is a hexadecimal string made up of hexadecimal and X (don't care) characters; otherwise, it is a binary string made up of 0, 1, and X (don't care) characters.

NOTE

If more bits are sent for <string> than specified by the :SBUS<n>:CAN:TRIGger:PATtern:DATA:LENGth command, the most significant bits will be truncated. If the data length is changed after the <string> is programmed, the added or deleted bits will be added to or deleted from the least significant bits.

Query Syntax :SBUS<n>:CAN:TRIGger:PATtern:DATA?

The :SBUS<n>:CAN:TRIGger:PATtern:DATA? query returns the current settings of the specified CAN data pattern resource in the binary string format.

Return Format <string><NL> in nondecimal format

Errors • **"-241, Hardware missing"** on page 1343

See Also • **"Introduction to :TRIGger Commands"** on page 1097
 • **":SBUS<n>:CAN:TRIGger:PATtern:DATA:LENGth"** on page 800
 • **":SBUS<n>:CAN:TRIGger:PATtern:ID"** on page 802

:SBUS<n>:CAN:TRIGger:PATtern:DATA:DLC

N (see [page 1384](#))

Command Syntax :SBUS<n>:CAN:TRIGger:PATtern:DATA:DLC <dlc>

<dlc> ::= integer between -1 (don't care) and 64, in NR1 format.

The :SBUS<n>:CAN:TRIGger:PATtern:DATA:DLC command specifies the DLC value to be used in the CAN FD data trigger mode. A specific valid FD value can be specified, or -1 can be specified to indicate "don't care".

Query Syntax :SBUS<n>:CAN:TRIGger:PATtern:DATA:START?

The :SBUS<n>:CAN:TRIGger:PATtern:DATA:DLC? query returns the currently set DLC value.

Return Format <dlc><NL>

<dlc> ::= integer between -1 (don't care) and 64, in NR1 format.

See Also • [":SBUS<n>:CAN:TRIGger:PATtern:DATA"](#) on page 798

:SBUS<n>:CAN:TRIGger:PATtern:DATA:LENGth

N (see [page 1384](#))

Command Syntax :SBUS<n>:CAN:TRIGger:PATtern:DATA:LENGth <length>
 <length> ::= integer from 1 to 8 in NR1 format

The :SBUS<n>:CAN:TRIGger:PATtern:DATA:LENGth command sets the number of 8-bit bytes in the CAN data string. The number of bytes in the string can be anywhere from 1 bytes to 8 bytes (64 bits). The value for these bytes is set by the :SBUS<n>:CAN:TRIGger:PATtern:DATA command.

Query Syntax :SBUS<n>:CAN:TRIGger:PATtern:DATA:LENGth?

The :SBUS<n>:CAN:TRIGger:PATtern:DATA:LENGth? query returns the current CAN data pattern length setting.

Return Format <count><NL>
 <count> ::= integer from 1 to 8 in NR1 format

Errors • ["-241, Hardware missing"](#) on page 1343

- See Also**
- ["Introduction to :TRIGger Commands"](#) on page 1097
 - [":SBUS<n>:CAN:TRIGger:PATtern:DATA"](#) on page 798
 - [":SBUS<n>:CAN:SOURce"](#) on page 793

:SBUS<n>:CAN:TRIGger:PATtern:DATA:START

N (see [page 1384](#))

Command Syntax :SBUS<n>:CAN:TRIGger:PATtern:DATA:START <start>

<start> ::= integer between 0 and 63, in NR1 format.

The :SBUS<n>:CAN:TRIGger:PATtern:DATA:START command specifies the starting byte position for CAN FD data triggers.

CAN FD frames can have up to 64 bytes of data. You can trigger on up to 8 bytes of data. The starting byte position setting lets you trigger on data anywhere within the frame.

Query Syntax :SBUS<n>:CAN:TRIGger:PATtern:DATA:START?

The :SBUS<n>:CAN:TRIGger:PATtern:DATA:START? query returns the starting byte position setting.

Return Format <start><NL>

<start> ::= integer between 0 and 63, in NR1 format.

- See Also**
- [":SBUS<n>:CAN:TRIGger:PATtern:DATA"](#) on page 798
 - [":SBUS<n>:CAN:TRIGger:PATtern:DATA:LENGth"](#) on page 800

:SBUS<n>:CAN:TRIGger:PATtern:ID

N (see [page 1384](#))

Command Syntax :SBUS<n>:CAN:TRIGger:PATtern:ID <string>

<string> ::= "nn...n" where n ::= {0 | 1 | X | \$}

<string ::= "0xnn...n" where n ::= {0,...,9 | A,...,F | X | \$}

The :SBUS<n>:CAN:TRIGger:PATtern:ID command defines the CAN identifier pattern resource according to the string parameter. This pattern, along with the identifier mode (set by the :SBUS<n>:CAN:TRIGger:PATtern:ID:MODE command), control the identifier pattern searched for in each CAN message.

If the string parameter starts with "0x", it is a hexadecimal string made up of hexadecimal and X (don't care) characters; otherwise, it is a binary string made up of 0, 1, and X (don't care) characters.

NOTE

The ID pattern resource string is always 29 bits. Only 11 of these bits are used when the :SBUS<n>:CAN:TRIGger:PATtern:ID:MODE is STANDard.

A string longer than 29 bits is truncated to 29 bits when setting the ID pattern resource.

Query Syntax :SBUS<n>:CAN:TRIGger:PATtern:ID?

The :SBUS<n>:CAN:TRIGger:PATtern:ID? query returns the current settings of the specified CAN identifier pattern resource in the 29-bit binary string format.

Return Format <string><NL> in 29-bit binary string format

Errors • ["-241, Hardware missing"](#) on page 1343

See Also • ["Introduction to :TRIGger Commands"](#) on page 1097
 • [":SBUS<n>:CAN:TRIGger:PATtern:ID:MODE"](#) on page 803
 • [":SBUS<n>:CAN:TRIGger:PATtern:DATA"](#) on page 798

:SBUS<n>:CAN:TRIGger:PATtern:ID:MODE

N (see [page 1384](#))

Command Syntax :SBUS<n>:CAN:TRIGger:PATtern:ID:MODE <value>
 <value> ::= {STANdard | EXTended}

The :SBUS<n>:CAN:TRIGger:PATtern:ID:MODE command sets the CAN identifier mode. STANdard selects the standard 11-bit identifier. EXTended selects the extended 29-bit identifier. The CAN identifier is set by the :SBUS<n>:CAN:TRIGger:PATtern:ID command.

Query Syntax :SBUS<n>:CAN:TRIGger:PATtern:ID:MODE?

The :SBUS<n>:CAN:TRIGger:PATtern:ID:MODE? query returns the current setting of the CAN identifier mode.

Return Format <value><NL>
 <value> ::= {STAN | EXT}

Errors • ["-241, Hardware missing"](#) on page 1343

- See Also**
- ["Introduction to :TRIGger Commands"](#) on page 1097
 - [":SBUS<n>:MODE"](#) on page 759
 - [":SBUS<n>:CAN:TRIGger:PATtern:DATA"](#) on page 798
 - [":SBUS<n>:CAN:TRIGger:PATtern:DATA:LENGth"](#) on page 800
 - [":SBUS<n>:CAN:TRIGger:PATtern:ID"](#) on page 802

:SBUS<n>:CAN:TRIGger:SYMBolic:MESSage

N (see [page 1384](#))

Command Syntax :SBUS<n>:CAN:TRIGger:SYMBolic:MESSage <name>

<name> ::= quoted ASCII string

The :SBUS<n>:CAN:TRIGger:SYMBolic:MESSage command specifies the message to trigger on when CAN symbolic data has been loaded (recalled) into the oscilloscope and the CAN trigger mode is set to MESSage or MSIGnal.

Query Syntax :SBUS<n>:CAN:TRIGger:SYMBolic:MESSage?

The :SBUS<n>:CAN:TRIGger:SYMBolic:MESSage? query returns the specified message.

Return Format <name><NL>

<name> ::= quoted ASCII string

- See Also**
- [":RECall:DBC\[:START\]"](#) on page 718
 - [":SBUS<n>:CAN:TRIGger"](#) on page 794
 - [":SBUS<n>:CAN:TRIGger:SYMBolic:SIGNal"](#) on page 805
 - [":SBUS<n>:CAN:TRIGger:SYMBolic:VALue"](#) on page 806

:SBUS<n>:CAN:TRIGger:SYMBolic:SIGNal

N (see [page 1384](#))

Command Syntax :SBUS<n>:CAN:TRIGger:SYMBolic:SIGNal <name>

<name> ::= quoted ASCII string

The :SBUS<n>:CAN:TRIGger:SYMBolic:SIGNal command specifies the signal to trigger on when CAN symbolic data has been loaded (recalled) into the oscilloscope and the CAN trigger mode is set to MSIGNAL.

Query Syntax :SBUS<n>:CAN:TRIGger:SYMBolic:SIGNal?

The :SBUS<n>:CAN:TRIGger:SYMBolic:SIGNal? query returns the specified signal.

Return Format <name><NL>

<name> ::= quoted ASCII string

- See Also**
- [":RECall:DBC\[:START\]"](#) on page 718
 - [":SBUS<n>:CAN:TRIGger"](#) on page 794
 - [":SBUS<n>:CAN:TRIGger:SYMBolic:MESSAge"](#) on page 804
 - [":SBUS<n>:CAN:TRIGger:SYMBolic:VALue"](#) on page 806

:SBUS<n>:CAN:TRIGger:SYMBolic:VALue

N (see [page 1384](#))

Command Syntax :SBUS<n>:CAN:TRIGger:SYMBolic:VALue <data>

<data> ::= value in NR3 format

The :SBUS<n>:CAN:TRIGger:SYMBolic:VALue command specifies the signal value to trigger on when CAN symbolic data has been loaded (recalled) into the oscilloscope and the CAN trigger mode is set to MSIGNAL.

NOTE

Encoded signal values are not supported in the remote interface (even though they can be used in the front panel graphical interface).

Query Syntax :SBUS<n>:CAN:TRIGger:SYMBolic:VALue?

The :SBUS<n>:CAN:TRIGger:SYMBolic:VALue? query returns the specified signal value.

Return Format <data><NL>

<data> ::= value in NR3 format

- See Also**
- [":RECall:DBC\[:START\]"](#) on page 718
 - [":SBUS<n>:CAN:TRIGger"](#) on page 794
 - [":SBUS<n>:CAN:TRIGger:SYMBolic:MESSAge"](#) on page 804
 - [":SBUS<n>:CAN:TRIGger:SYMBolic:SIGNal"](#) on page 805

:SBUS<n>:CXPI Commands

NOTE

These commands are valid when the CXPI (Clock Extension Peripheral Interface) serial decode and triggering option has been licensed.

Table 114: :SBUS<n>:CXPI Commands Summary

Command	Query	Options and Query Returns
:SBUS<n>:CXPI:BAUDrate <baudrate> (see page 809)	:SBUS<n>:CXPI:BAUDrate? (see page 809)	<baudrate> ::= integer from 9600 to 40000 in 100 b/s increments.
:SBUS<n>:CXPI:PARity {{0 OFF} {1 ON}} (see page 810)	:SBUS<n>:CXPI:PARity? (see page 810)	{0 1}
:SBUS<n>:CXPI:SOURce <source> (see page 811)	:SBUS<n>:CXPI:SOURce? (see page 811)	<source> ::= {CHANnel<n>} <n> ::= 1 to (# analog channels) in NR1 format
:SBUS<n>:CXPI:TOLerance <percent> (see page 812)	:SBUS<n>:CXPI:TOLerance? (see page 812)	<percent> ::= from 1-30, in NR1 format.
:SBUS<n>:CXPI:TRIGger <mode> (see page 813)	:SBUS<n>:CXPI:TRIGger? (see page 814)	<mode> ::= {SOF EOF PTYPe ID DATA LDATa CRCerror PARityerror IBSerror IFSerror FRAMingerror DLENgtherror SAMPlerror ALLerrors SLEepframe WAKEuppulse}
:SBUS<n>:CXPI:TRIGger:IDFilter {{0 OFF} {1 ON}} (see page 815)	:SBUS<n>:CXPI:TRIGger:IDFilter? (see page 815)	{0 1}
:SBUS<n>:CXPI:TRIGger:PTYPe {{0 OFF} {1 ON}} (see page 816)	:SBUS<n>:CXPI:TRIGger:PTYPe? (see page 816)	{0 1}
:SBUS<n>:CXPI:TRIGger:PATtern:DATA <string> (see page 817)	:SBUS<n>:CXPI:TRIGger:PATtern:DATA? (see page 817)	<string> ::= "nn...n" where n ::= {0 1 X} <string> ::= "0xnn...n" where n ::= {0,...,9 A,...,F X}
:SBUS<n>:CXPI:TRIGger:PATtern:DATA:LENGth <length> (see page 818)	:SBUS<n>:CXPI:TRIGger:PATtern:DATA:LENGth? (see page 818)	<start> ::= integer between 0 and 12, in NR1 format.

Table 114: :SBUS<n>:CXPI Commands Summary (continued)

Command	Query	Options and Query Returns
:SBUS<n>:CXPI:TRIGger :PATtern:DATA:START <start> (see page 819)	:SBUS<n>:CXPI:TRIGger :PATtern:DATA:START? (see page 819)	<start> ::= integer between 0 and 255, in NR1 format.
:SBUS<n>:CXPI:TRIGger :PATtern:ID <string> (see page 820)	:SBUS<n>:CXPI:TRIGger :PATtern:ID? (see page 820)	<string> ::= "nn...n" where n ::= {0 1 X} <string> ::= "0xnn...n" where n ::= {0,...,9 A,...,F X}
:SBUS<n>:CXPI:TRIGger :PATtern:INFO:CT <string> (see page 821)	:SBUS<n>:CXPI:TRIGger :PATtern:INFO:CT? (see page 821)	<string> ::= "nn" where n ::= {0 1 X}
:SBUS<n>:CXPI:TRIGger :PATtern:INFO:DLC <dlc> (see page 822)	:SBUS<n>:CXPI:TRIGger :PATtern:INFO:DLC? (see page 822)	<dlc> ::= integer between -1 (don't care) and 15, in NR1 format, when trigger is in DATA mode. <dlc> ::= integer between -1 (don't care) and 255, in NR1 format, when trigger is in LDATa mode.
:SBUS<n>:CXPI:TRIGger :PATtern:INFO:NM <string> (see page 823)	:SBUS<n>:CXPI:TRIGger :PATtern:INFO:NM? (see page 823)	<string> ::= "nn" where n ::= {0 1 X}

:SBUS<n>:CXPI:BAUDrate

N (see [page 1384](#))

Command Syntax :SBUS<n>:CXPI:BAUDrate <baudrate>

<baudrate> ::= integer from 9600 to 40000 in 100 b/s increments.

The :SBUS<n>:CXPI:BAUDrate command specifies the baud rate of the CXPI signal from your device under test.

The CXPI baud rate can be set from 9600 b/s to 40000 b/s in 100 b/s increments.

You must set the baud rate to match your device under test.

The default baud rate is 20 kb/s.

Query Syntax :SBUS<n>:CXPI:BAUDrate?

The :SBUS<n>:CXPI:BAUDrate? query returns the baud rate setting.

Return Format <baudrate><NL>

<baudrate> ::= integer from 9600 to 40000 in 100 b/s increments.

- See Also**
- [":SBUS<n>:CXPI:PARity"](#) on page 810
 - [":SBUS<n>:CXPI:SOURce"](#) on page 811
 - [":SBUS<n>:CXPI:TOLerance"](#) on page 812
 - [":SBUS<n>:CXPI:TRIGger"](#) on page 813

:SBUS<n>:CXPI:PARity

N (see [page 1384](#))

Command Syntax :SBUS<n>:CXPI:PARity {{0 | OFF} | {1 | ON}}

The :SBUS<n>:CXPI:PARity command specifies whether the parity bit should be displayed in the identifier field.

When OFF, the upper bit is masked. The parity is still checked, but it is not displayed unless a parity error occurs.

Query Syntax :SBUS<n>:CXPI:PARity?

The :SBUS<n>:CXPI:PARity? query returns the parity display setting.

Return Format <setting><NL>

<setting> ::= {0 | 1}

- See Also**
- [":SBUS<n>:CXPI:BAUDrate"](#) on page 809
 - [":SBUS<n>:CXPI:SOURce"](#) on page 811
 - [":SBUS<n>:CXPI:TOLerance"](#) on page 812
 - [":SBUS<n>:CXPI:TRIGger"](#) on page 813

:SBUS<n>:CXPI:SOURce

N (see [page 1384](#))

Command Syntax :SBUS<n>:CXPI:SOURce <source>

<source> ::= {CHANnel<n>}

<n> ::= 1 to (# analog channels) in NR1 format

The :SBUS<n>:CXPI:SOURce command selects the oscilloscope channel connected to the CXPI signal line.

Query Syntax :SBUS<n>:CXPI:SOURce?

The :SBUS<n>:CXPI:SOURce? query returns the selected oscilloscope channel source.

Return Format <source><NL>

<source> ::= {CHAN<n>}

- See Also**
- [":SBUS<n>:CXPI:BAUDrate"](#) on page 809
 - [":SBUS<n>:CXPI:PARity"](#) on page 810
 - [":SBUS<n>:CXPI:TOLerance"](#) on page 812
 - [":SBUS<n>:CXPI:TRIGger"](#) on page 813

:SBUS<n>:CXPI:TOLerance

N (see [page 1384](#))

Command Syntax :SBUS<n>:CXPI:TOLerance <percent>

<percent> ::= from 1-30, in NR1 format.

The :SBUS<n>:CXPI:TOLerance command specifies the tolerance as a percentage of the Tbit width.

Query Syntax :SBUS<n>:CXPI:TOLerance?

The :SBUS<n>:CXPI:TOLerance? query returns the tolerance setting.

Return Format <percent><NL>

<percent> ::= from 1-30, in NR1 format.

- See Also**
- [":SBUS<n>:CXPI:BAUDrate"](#) on page 809
 - [":SBUS<n>:CXPI:PARity"](#) on page 810
 - [":SBUS<n>:CXPI:SOURce"](#) on page 811
 - [":SBUS<n>:CXPI:TRIGger"](#) on page 813

:SBUS<n>:CXPI:TRIGger

N (see [page 1384](#))

Command Syntax :SBUS<n>:CXPI:TRIGger <mode>

```
<mode> ::= {SOF | EOF | PTYPe | ID | DATA | LDATa | CRCerror
           | PARityerror | IBSerror | IFSerror | FRAMingerror | DLENgtherror
           | SAMPlerror | ALLerrors | SLEepframe | WAKEuppulse}
```

The :SBUS<n>:CXPI:TRIGger command selects the CXPI trigger type:

- SOF – (Start of Frame) triggers at the start bit of any frame.
- EOF – (End of Frame) triggers at the end of any frame.
- PTYPe – triggers on any frame that starts with the special PTYPE byte.

PTYPE frames begins with an extra PID byte with a Frame ID of 0000000b (reserved for only PTYPE frames). The PTYPE PID byte is then followed by a regular PID byte and the rest of the normal frame. The extra PTYPE byte is never included in the CRC calculation.

- ID – (Frame ID) triggers on a user-defined Frame ID at the end of the PID byte. The Frame ID value is user-defined, 7 bits, and has bitwise don't-cares. You can specify whether to trigger on PTYPE present or no PTYPE present.
- DATA – (Frame ID, Info and Data) triggers on CXPI frames at the end of the last data byte defined in the trigger. In addition to the PID value, you can specify the contents of the Frame Info byte with bitwise don't-cares. You can specify up to 12 data bytes on which to trigger with bitwise don't-cares.
- LDATa – (Frame ID, Info and Data (Long Frame)) triggers on CXPI frames at the end of the last data byte defined in the trigger. The standard DLC field will be locked to 1111b. You can specify up to 12 bytes of data on which to trigger and specify the start byte number as an offset. The offset can be up to 255.
- CRCerror – (CRC Field Error) triggers when the calculated CRC does not match the transmitted CRC. You can optionally filter by Frame ID and PTYPE as in the Frame ID trigger.
- PARityerror – triggers when the parity bit in the PID or PTYPE field is not correct.
- IBSerror – (Inter-Byte Space Error) triggers when there are more than 9 bits between consecutive bytes in a frame. You can optionally filter by Frame ID and PTYPE as in the Frame ID trigger.
- IFSerror – (Inter-Frame Space Error) triggers when there are fewer than 10 idle bits before a new frame begins.
- FRAMingerror – triggers when the stop bit of a byte is not logical 1. You can optionally filter by Frame ID and PTYPE as in the Frame ID trigger.
- DLENgtherror – (Data Length Error) triggers when there are more data bytes in a frame than is indicated by the DLC or Extended DLC field. You can optionally filter by Frame ID and PTYPE as in the Frame ID trigger.

- **SAMPlerror** – triggers when 10 consecutive logical 0s are detected.
- **ALLerrors** – triggers on all CRC, Parity, IBS, Stop Bit, Data Length, and Sample errors.
- **SLEepframe** – triggers when a normal frame is transmitted matching the definition of a sleep frame in the CXPI specification.
- **WAKEuppulse** – triggers when a wakeup pulse is detected.

Query Syntax :SBUS<n>:CXPI:TRIGger?

The :SBUS<n>:CXPI:TRIGger? query returns the CXPI trigger type setting.

Return Format <mode><NL>

```
<mode> ::= {SOF | EOF | PTYP | ID | DATA | LDAT | CRC | PAR | IBS
           | IFS | FRAM | DLEN | SAMP | ALL | SLE | WAK}
```

- See Also**
- **":SBUS<n>:CXPI:BAUDrate"** on page 809
 - **":SBUS<n>:CXPI:PARity"** on page 810
 - **":SBUS<n>:CXPI:SOURce"** on page 811
 - **":SBUS<n>:CXPI:TOLerance"** on page 812
 - **":SBUS<n>:CXPI:TRIGger:IDFilter"** on page 815
 - **":SBUS<n>:CXPI:TRIGger:PTYPe"** on page 816
 - **":SBUS<n>:CXPI:TRIGger:PATTern:DATA"** on page 817
 - **":SBUS<n>:CXPI:TRIGger:PATTern:DATA:LENGth"** on page 818
 - **":SBUS<n>:CXPI:TRIGger:PATTern:DATA:START"** on page 819
 - **":SBUS<n>:CXPI:TRIGger:PATTern:ID"** on page 820
 - **":SBUS<n>:CXPI:TRIGger:PATTern:INFO:CT"** on page 821
 - **":SBUS<n>:CXPI:TRIGger:PATTern:INFO:DLC"** on page 822
 - **":SBUS<n>:CXPI:TRIGger:PATTern:INFO:NM"** on page 823

:SBUS<n>:CXPI:TRIGger:IDFilter

N (see [page 1384](#))

Command Syntax :SBUS<n>:CXPI:TRIGger:IDFilter {{0 | OFF} | {1 | ON}}

When triggering on CRC Field Errors, Inter-Byte Space Errors, Framing Errors, or Data Length Errors, the :SBUS<n>:CXPI:TRIGger:IDFilter command lets you enable/disable modification of the trigger so that it occurs only for a specified ID.

Query Syntax :SBUS<n>:CXPI:TRIGger:IDFilter?

The :SBUS<n>:CXPI:TRIGger:IDFilter? query returns the ID filter setting.

Return Format <setting><NL>

<setting> ::= {0 | 1}

- See Also**
- [":SBUS<n>:CXPI:TRIGger"](#) on page 813
 - [":SBUS<n>:CXPI:TRIGger:PTYPe"](#) on page 816
 - [":SBUS<n>:CXPI:TRIGger:PATTern:DATA"](#) on page 817
 - [":SBUS<n>:CXPI:TRIGger:PATTern:DATA:LENGth"](#) on page 818
 - [":SBUS<n>:CXPI:TRIGger:PATTern:DATA:STARt"](#) on page 819
 - [":SBUS<n>:CXPI:TRIGger:PATTern:ID"](#) on page 820
 - [":SBUS<n>:CXPI:TRIGger:PATTern:INFO:CT"](#) on page 821
 - [":SBUS<n>:CXPI:TRIGger:PATTern:INFO:DLC"](#) on page 822
 - [":SBUS<n>:CXPI:TRIGger:PATTern:INFO:NM"](#) on page 823

:SBUS<n>:CXPI:TRIGger:PTYPE

N (see [page 1384](#))

Command Syntax :SBUS<n>:CXPI:TRIGger:PTYPE {{0 | OFF} | {1 | ON}}

For the trigger types that let you trigger on data, the :SBUS<n>:CXPI:TRIGger:PTYPE command specifies whether you want to trigger when the special PTYPE byte is present (ON) or not present (OFF).

Query Syntax :SBUS<n>:CXPI:TRIGger:PTYPE?

The :SBUS<n>:CXPI:TRIGger:PTYPE? query returns the PTYPE trigger setting.

Return Format <setting><NL>
<setting> ::= {0 | 1}

- See Also**
- [":SBUS<n>:CXPI:TRIGger"](#) on page 813
 - [":SBUS<n>:CXPI:TRIGger:IDFilter"](#) on page 815
 - [":SBUS<n>:CXPI:TRIGger:PATtern:DATA"](#) on page 817
 - [":SBUS<n>:CXPI:TRIGger:PATtern:DATA:LENGth"](#) on page 818
 - [":SBUS<n>:CXPI:TRIGger:PATtern:DATA:STARt"](#) on page 819
 - [":SBUS<n>:CXPI:TRIGger:PATtern:ID"](#) on page 820
 - [":SBUS<n>:CXPI:TRIGger:PATtern:INFO:CT"](#) on page 821
 - [":SBUS<n>:CXPI:TRIGger:PATtern:INFO:DLC"](#) on page 822
 - [":SBUS<n>:CXPI:TRIGger:PATtern:INFO:NM"](#) on page 823

:SBUS<n>:CXPI:TRIGger:PATtern:DATA

N (see [page 1384](#))

Command Syntax :SBUS<n>:CXPI:TRIGger:PATtern:DATA <string>
 <string> ::= "nn...n" where n ::= {0 | 1 | X}
 <string ::= "0xnn...n" where n ::= {0,...,9 | A,...,F | X}

For the trigger types that let you trigger on data, the :SBUS<n>:CXPI:TRIGger:PATtern:DATA command lets you specify the data value.

The :SBUS<n>:CXPI:TRIGger:PATtern:DATA:LENGth command specifies the length of the data to trigger on, from 0 to 12 bytes, limited by the data length code (DLC) setting of the :SBUS<n>:CXPI:TRIGger:PATtern:INFO:DLC command.

When triggering on long frames (with the LDATa trigger type) that can have up to 255 data bytes, the maximum number of data bytes you can include in the trigger specification is still only 12 bytes. In this case, you can use the :SBUS<n>:CXPI:TRIGger:PATtern:DATA:STARt command to specify the starting byte location where the data value should be found.

Query Syntax :SBUS<n>:CXPI:TRIGger:PATtern:DATA?

The :SBUS<n>:CXPI:TRIGger:PATtern:DATA? query returns the specified data value.

Returned data values are always quoted binary format strings.

Return Format <string><NL>
 <string> ::= "nn...n" where n ::= {0 | 1 | X}

- See Also**
- [":SBUS<n>:CXPI:TRIGger"](#) on page 813
 - [":SBUS<n>:CXPI:TRIGger:IDFilter"](#) on page 815
 - [":SBUS<n>:CXPI:TRIGger:PTYPE"](#) on page 816
 - [":SBUS<n>:CXPI:TRIGger:PATtern:DATA:LENGth"](#) on page 818
 - [":SBUS<n>:CXPI:TRIGger:PATtern:DATA:STARt"](#) on page 819
 - [":SBUS<n>:CXPI:TRIGger:PATtern:ID"](#) on page 820
 - [":SBUS<n>:CXPI:TRIGger:PATtern:INFO:CT"](#) on page 821
 - [":SBUS<n>:CXPI:TRIGger:PATtern:INFO:DLC"](#) on page 822
 - [":SBUS<n>:CXPI:TRIGger:PATtern:INFO:NM"](#) on page 823

:SBUS<n>:CXPI:TRIGger:PATtern:DATA:LENGth

N (see [page 1384](#))

Command Syntax :SBUS<n>:CXPI:TRIGger:PATtern:DATA:LENGth <length>
 <length> ::= integer between 0 and 12, in NR1 format.

For the trigger types that let you trigger on data, the :SBUS<n>:CXPI:TRIGger:PATtern:DATA:LENGth command specifies the length of the data to trigger on, from 0 to 12 bytes, limited by the data length code (DLC) setting of the :SBUS<n>:CXPI:TRIGger:PATtern:INFO:DLC command.

The :SBUS<n>:CXPI:TRIGger:PATtern:DATA command lets you specify the data value to trigger on.

Query Syntax :SBUS<n>:CXPI:TRIGger:PATtern:DATA:LENGth?

The :SBUS<n>:CXPI:TRIGger:PATtern:DATA:LENGth? query returns the data length setting.

Return Format <length><NL>
 <length> ::= integer between 0 and 12, in NR1 format.

- See Also**
- [":SBUS<n>:CXPI:TRIGger"](#) on page 813
 - [":SBUS<n>:CXPI:TRIGger:IDFilter"](#) on page 815
 - [":SBUS<n>:CXPI:TRIGger:PTYPE"](#) on page 816
 - [":SBUS<n>:CXPI:TRIGger:PATtern:DATA"](#) on page 817
 - [":SBUS<n>:CXPI:TRIGger:PATtern:DATA:START"](#) on page 819
 - [":SBUS<n>:CXPI:TRIGger:PATtern:ID"](#) on page 820
 - [":SBUS<n>:CXPI:TRIGger:PATtern:INFO:CT"](#) on page 821
 - [":SBUS<n>:CXPI:TRIGger:PATtern:INFO:DLC"](#) on page 822
 - [":SBUS<n>:CXPI:TRIGger:PATtern:INFO:NM"](#) on page 823

:SBUS<n>:CXPI:TRIGger:PATtern:DATA:START

N (see [page 1384](#))

Command Syntax :SBUS<n>:CXPI:TRIGger:PATtern:DATA:START <start>

<start> ::= integer between 0 and 255, in NR1 format.

When triggering on long frames (with the LDATA trigger type) that can have up to 255 data bytes, the maximum number of data bytes you can include in the trigger specification is still only 12 bytes. In this case, you can use the :SBUS<n>:CXPI:TRIGger:PATtern:DATA:START command to specify the starting byte location where the data value should be found.

The :SBUS<n>:CXPI:TRIGger:PATtern:DATA:LENGth command lets you specify the length of the data value to trigger on.

The :SBUS<n>:CXPI:TRIGger:PATtern:DATA command lets you specify the data value to trigger on.

Query Syntax :SBUS<n>:CXPI:TRIGger:PATtern:DATA:START?

The :SBUS<n>:CXPI:TRIGger:PATtern:DATA:START? query returns the start byte setting.

Return Format <start><NL>

<start> ::= integer between 0 and 255, in NR1 format.

- See Also**
- [":SBUS<n>:CXPI:TRIGger"](#) on page 813
 - [":SBUS<n>:CXPI:TRIGger:IDFilter"](#) on page 815
 - [":SBUS<n>:CXPI:TRIGger:PTYPE"](#) on page 816
 - [":SBUS<n>:CXPI:TRIGger:PATtern:DATA"](#) on page 817
 - [":SBUS<n>:CXPI:TRIGger:PATtern:DATA:LENGth"](#) on page 818
 - [":SBUS<n>:CXPI:TRIGger:PATtern:ID"](#) on page 820
 - [":SBUS<n>:CXPI:TRIGger:PATtern:INFO:CT"](#) on page 821
 - [":SBUS<n>:CXPI:TRIGger:PATtern:INFO:DLC"](#) on page 822
 - [":SBUS<n>:CXPI:TRIGger:PATtern:INFO:NM"](#) on page 823

:SBUS<n>:CXPI:TRIGger:PATtern:ID

N (see [page 1384](#))

Command Syntax :SBUS<n>:CXPI:TRIGger:PATtern:ID <string>

<string> ::= "nn...n" where n ::= {0 | 1 | X}

<string ::= "0xnn...n" where n ::= {0,...,9 | A,...,F | X}

For the trigger types that let you specify frame ID values in the trigger or allow filtering by the frame ID, the :SBUS<n>:CXPI:TRIGger:PATtern:ID command lets you specify the frame ID value.

Query Syntax :SBUS<n>:CXPI:TRIGger:PATtern:ID?

The :SBUS<n>:CXPI:TRIGger:PATtern:ID? query returns the specified frame ID value.

Returned frame ID values are always quoted binary format strings.

Return Format <string><NL>

<string> ::= "nn...n" where n ::= {0 | 1 | X}

- See Also**
- [":SBUS<n>:CXPI:TRIGger"](#) on page 813
 - [":SBUS<n>:CXPI:TRIGger:IDFilter"](#) on page 815
 - [":SBUS<n>:CXPI:TRIGger:PTYPE"](#) on page 816
 - [":SBUS<n>:CXPI:TRIGger:PATtern:DATA"](#) on page 817
 - [":SBUS<n>:CXPI:TRIGger:PATtern:DATA:LENGth"](#) on page 818
 - [":SBUS<n>:CXPI:TRIGger:PATtern:DATA:START"](#) on page 819
 - [":SBUS<n>:CXPI:TRIGger:PATtern:INFO:CT"](#) on page 821
 - [":SBUS<n>:CXPI:TRIGger:PATtern:INFO:DLC"](#) on page 822
 - [":SBUS<n>:CXPI:TRIGger:PATtern:INFO:NM"](#) on page 823

:SBUS<n>:CXPI:TRIGger:PATtern:INFO:CT

N (see [page 1384](#))

Command Syntax :SBUS<n>:CXPI:TRIGger:PATtern:INFO:CT <string>
 <string> ::= "nn" where n ::= {0 | 1 | X}

The command ...

For the trigger types that let you trigger on data, as well as frame ID and frame information bits, the :SBUS<n>:CXPI:TRIGger:PATtern:INFO:CT command lets you specify the Count (CT) value of the CXPI frame you wish to trigger on. This is a two-bit binary value.

Query Syntax :SBUS<n>:CXPI:TRIGger:PATtern:INFO:CT?

The :SBUS<n>:CXPI:TRIGger:PATtern:INFO:CT? query returns the specified CT bits included in the trigger.

Return Format <string><NL>
 <string> ::= "nn" where n ::= {0 | 1 | X}

- See Also**
- [":SBUS<n>:CXPI:TRIGger"](#) on page 813
 - [":SBUS<n>:CXPI:TRIGger:IDFilter"](#) on page 815
 - [":SBUS<n>:CXPI:TRIGger:PTYPE"](#) on page 816
 - [":SBUS<n>:CXPI:TRIGger:PATtern:DATA"](#) on page 817
 - [":SBUS<n>:CXPI:TRIGger:PATtern:DATA:LENGth"](#) on page 818
 - [":SBUS<n>:CXPI:TRIGger:PATtern:DATA:START"](#) on page 819
 - [":SBUS<n>:CXPI:TRIGger:PATtern:ID"](#) on page 820
 - [":SBUS<n>:CXPI:TRIGger:PATtern:INFO:DLC"](#) on page 822
 - [":SBUS<n>:CXPI:TRIGger:PATtern:INFO:NM"](#) on page 823

:SBUS<n>:CXPI:TRIGger:PATtern:INFO:DLC

N (see [page 1384](#))

Command Syntax :SBUS<n>:CXPI:TRIGger:PATtern:INFO:DLC <dlc>

<dlc> ::= integer between -1 (don't care) and 15, in NR1 format, when trigger is in DATA mode.

<dlc> ::= integer between -1 (don't care) and 255, in NR1 format, when trigger is in LDATa mode.

For the trigger types that let you trigger on data, the :SBUS<n>:CXPI:TRIGger:PATtern:INFO:DLC command specifies the data length code of the CXPI frame you wish to trigger on.

This will also affect the number of data bytes you can specify in the trigger.

Query Syntax :SBUS<n>:CXPI:TRIGger:PATtern:INFO:DLC?

The :SBUS<n>:CXPI:TRIGger:PATtern:INFO:DLC? query returns the DLC trigger value setting.

Return Format <dlc><NL>

<dlc> ::= integer between -1 (don't care) and 15, in NR1 format, when trigger is in DATA mode.

<dlc> ::= integer between -1 (don't care) and 255, in NR1 format, when trigger is in LDATa mode.

- See Also**
- [":SBUS<n>:CXPI:TRIGger"](#) on page 813
 - [":SBUS<n>:CXPI:TRIGger:IDFilter"](#) on page 815
 - [":SBUS<n>:CXPI:TRIGger:PTYPE"](#) on page 816
 - [":SBUS<n>:CXPI:TRIGger:PATtern:DATA"](#) on page 817
 - [":SBUS<n>:CXPI:TRIGger:PATtern:DATA:LENGth"](#) on page 818
 - [":SBUS<n>:CXPI:TRIGger:PATtern:DATA:START"](#) on page 819
 - [":SBUS<n>:CXPI:TRIGger:PATtern:ID"](#) on page 820
 - [":SBUS<n>:CXPI:TRIGger:PATtern:INFO:CT"](#) on page 821
 - [":SBUS<n>:CXPI:TRIGger:PATtern:INFO:NM"](#) on page 823

:SBUS<n>:CXPI:TRIGger:PATtern:INFO:NM

N (see [page 1384](#))

Command Syntax :SBUS<n>:CXPI:TRIGger:PATtern:INFO:NM <string>
 <string> ::= "nn" where n ::= {0 | 1 | X}

For the trigger types that let you trigger on data, as well as frame ID and frame information bits, the :SBUS<n>:CXPI:TRIGger:PATtern:INFO:NM command lets you specify the Network Management (NM) value of the CXPI frame you wish to trigger on. This is a two-bit binary value.

Query Syntax :SBUS<n>:CXPI:TRIGger:PATtern:INFO:NM?

The :SBUS<n>:CXPI:TRIGger:PATtern:INFO:NM? query returns the specified NM bits included in the trigger.

Return Format <string><NL>
 <string> ::= "nn" where n ::= {0 | 1 | X}

- See Also**
- [":SBUS<n>:CXPI:TRIGger"](#) on page 813
 - [":SBUS<n>:CXPI:TRIGger:IDFilter"](#) on page 815
 - [":SBUS<n>:CXPI:TRIGger:PTYPE"](#) on page 816
 - [":SBUS<n>:CXPI:TRIGger:PATtern:DATA"](#) on page 817
 - [":SBUS<n>:CXPI:TRIGger:PATtern:DATA:LENGth"](#) on page 818
 - [":SBUS<n>:CXPI:TRIGger:PATtern:DATA:START"](#) on page 819
 - [":SBUS<n>:CXPI:TRIGger:PATtern:ID"](#) on page 820
 - [":SBUS<n>:CXPI:TRIGger:PATtern:INFO:CT"](#) on page 821
 - [":SBUS<n>:CXPI:TRIGger:PATtern:INFO:DLC"](#) on page 822

:SBUS<n>:FLEXray Commands

NOTE

These commands are only valid when the FLEXray triggering and serial decode option (Option FLEX) has been licensed.

Table 115: :SBUS<n>:FLEXray Commands Summary

Command	Query	Options and Query Returns
:SBUS<n>:FLEXray:AUTOsetup (see page 826)	n/a	n/a
:SBUS<n>:FLEXray:BAUDrate <baudrate> (see page 827)	:SBUS<n>:FLEXray:BAUDrate? (see page 827)	<baudrate> ::= {2500000 5000000 10000000}
:SBUS<n>:FLEXray:CHANnel <channel> (see page 828)	:SBUS<n>:FLEXray:CHANnel? (see page 828)	<channel> ::= {A B}
n/a	:SBUS<n>:FLEXray:COUNt:NULL? (see page 829)	<frame_count> ::= integer in NR1 format
:SBUS<n>:FLEXray:COUNt:RESet (see page 830)	n/a	n/a
n/a	:SBUS<n>:FLEXray:COUNt:SYNC? (see page 831)	<frame_count> ::= integer in NR1 format
n/a	:SBUS<n>:FLEXray:COUNt:TOTal? (see page 832)	<frame_count> ::= integer in NR1 format
:SBUS<n>:FLEXray:SOURce <source> (see page 833)	:SBUS<n>:FLEXray:SOURce? (see page 833)	<source> ::= {CHANnel<n>} <n> ::= 1-2 or 1-4 in NR1 format
:SBUS<n>:FLEXray:TRIGger <condition> (see page 834)	:SBUS<n>:FLEXray:TRIGger? (see page 834)	<condition> ::= {FRAME ERRor EVENT}
:SBUS<n>:FLEXray:TRIGger:ERRor:TYPE <error_type> (see page 835)	:SBUS<n>:FLEXray:TRIGger:ERRor:TYPE? (see page 835)	<error_type> ::= {ALL HCRC FCRC}
:SBUS<n>:FLEXray:TRIGger:EVENT:AUTOset (see page 836)	n/a	n/a
:SBUS<n>:FLEXray:TRIGger:EVENT:BSS:ID <frame_id> (see page 837)	:SBUS<n>:FLEXray:TRIGger:EVENT:BSS:ID? (see page 837)	<frame_id> ::= {ALL <frame #>} <frame #> ::= integer from 1-2047

Table 115: :SBUS<n>:FLEXray Commands Summary (continued)

Command	Query	Options and Query Returns
:SBUS<n>:FLEXray:TRIGGER:EVENT:TYPE <event> (see page 838)	:SBUS<n>:FLEXray:TRIGGER:EVENT:TYPE? (see page 838)	<event> ::= {WAKEup TSS {FES DTS} BSS}
:SBUS<n>:FLEXray:TRIGGER:FRAME:CCBase <cycle_count_base> (see page 839)	:SBUS<n>:FLEXray:TRIGGER:FRAME:CCBase? (see page 839)	<cycle_count_base> ::= integer from 0-63
:SBUS<n>:FLEXray:TRIGGER:FRAME:CCRepetition <cycle_count_repetition> (see page 840)	:SBUS<n>:FLEXray:TRIGGER:FRAME:CCRepetition? (see page 840)	<cycle_count_repetition> ::= {ALL <rep #>} <rep #> ::= integer values 2, 4, 8, 16, 32, or 64
:SBUS<n>:FLEXray:TRIGGER:FRAME:ID <frame_id> (see page 841)	:SBUS<n>:FLEXray:TRIGGER:FRAME:ID? (see page 841)	<frame_id> ::= {ALL <frame #>} <frame #> ::= integer from 1-2047
:SBUS<n>:FLEXray:TRIGGER:FRAME:TYPE <frame_type> (see page 842)	:SBUS<n>:FLEXray:TRIGGER:FRAME:TYPE? (see page 842)	<frame_type> ::= {NORMAL STARTup NULL SYNC NSTartup NNUL1 NSYNc ALL}

:SBUS<n>:FLEXray:AUTOsetup

N (see [page 1384](#))

Command Syntax :SBUS<n>:FLEXray:AUTOsetup

The :SBUS<n>:FLEXray:AUTOsetup command automatically configures oscilloscope settings to facilitate FlexRay triggering and serial decode.

- Sets the selected source channel's impedance to 50 Ohms.
- Sets the selected source channel's probe attenuation to 10:1.
- Sets the trigger level (on the selected source channel) to -300 mV.
- Turns on trigger Noise Reject.
- Turns on Serial Decode.
- Sets the trigger to the specified serial bus (n of SBUS<n>).

- See Also**
- ["Introduction to :TRIGger Commands"](#) on page 1097
 - [":SBUS<n>:FLEXray:TRIGger"](#) on page 834
 - [":SBUS<n>:FLEXray:BAUDrate"](#) on page 827
 - [":TRIGger\[:EDGE\]:LEVel"](#) on page 1123
 - [":SBUS<n>:FLEXray:SOURce"](#) on page 833

:SBUS<n>:FLEXray:BAUDrate

N (see [page 1384](#))

Command Syntax :SBUS<n>:FLEXray:BAUDrate <baudrate>

<baudrate> ::= {2500000 | 5000000 | 10000000}

The :SBUS<n>:FLEXray:BAUDrate command specifies the baud rate as 2.5 Mb/s, 5 Mb/s, or 10 Mb/s.

Query Syntax :SBUS<n>:FLEXray:BAUDrate?

The :SBUS<n>:FLEXray:BAUDrate? query returns the current baud rate setting.

Return Format <baudrate><NL>

<baudrate> ::= {2500000 | 5000000 | 10000000}

- See Also**
- ["Introduction to :TRIGger Commands"](#) on page 1097
 - [":SBUS<n>:FLEXray Commands"](#) on page 824

:SBUS<n>:FLEXray:CHANnel

N (see [page 1384](#))

Command Syntax :SBUS<n>:FLEXray:CHANnel <channel>
<channel> ::= {A | B}

The :SBUS<n>:FLEXray:CHANnel command specifies the bus channel, A or B, of the FlexRay signal.

Query Syntax :SBUS<n>:FLEXray:CHANnel?

The :SBUS<n>:FLEXray:CHANnel? query returns the current bus channel setting.

Return Format <channel><NL>

<channel> ::= {A | B}

- See Also**
- ["Introduction to :TRIGger Commands"](#) on page 1097
 - [":SBUS<n>:FLEXray Commands"](#) on page 824

:SBUS<n>:FLEXray:COUNT:NULL

N (see [page 1384](#))

Query Syntax :SBUS<n>:FLEXray:COUNT:NULL?

Returns the FlexRay null frame count.

Return Format <frame_count><NL>

<frame_count> ::= integer in NR1 format

Errors • ["-241, Hardware missing"](#) on page 1343

- See Also**
- [":SBUS<n>:FLEXray:COUNT:RESet"](#) on page 830
 - [":SBUS<n>:FLEXray:COUNT:TOTal"](#) on page 832
 - [":SBUS<n>:FLEXray:COUNT:SYNC"](#) on page 831
 - ["Introduction to :SBUS<n> Commands"](#) on page 755
 - [":SBUS<n>:MODE"](#) on page 759
 - [":SBUS<n>:FLEXray Commands"](#) on page 824

:SBUS<n>:FLEXray:COUNT:RESet

N (see [page 1384](#))

Command Syntax :SBUS<n>:FLEXray:COUNT:RESet

Resets the FlexRay frame counters.

Errors · ["-241, Hardware missing"](#) on page 1343

- See Also** · [":SBUS<n>:FLEXray:COUNT:NULL"](#) on page 829
- [":SBUS<n>:FLEXray:COUNT:TOTal"](#) on page 832
 - [":SBUS<n>:FLEXray:COUNT:SYNC"](#) on page 831
 - ["Introduction to :SBUS<n> Commands"](#) on page 755
 - [":SBUS<n>:MODE"](#) on page 759
 - [":SBUS<n>:FLEXray Commands"](#) on page 824

:SBUS<n>:FLEXray:COUNT:SYNC

N (see [page 1384](#))

Query Syntax :SBUS<n>:FLEXray:COUNT:SYNC?

Returns the FlexRay sync frame count.

Return Format <frame_count><NL>

<frame_count> ::= integer in NR1 format

Errors • ["-241, Hardware missing"](#) on page 1343

- See Also**
- [":SBUS<n>:FLEXray:COUNT:RESet"](#) on page 830
 - [":SBUS<n>:FLEXray:COUNT:TOTal"](#) on page 832
 - [":SBUS<n>:FLEXray:COUNT:NULL"](#) on page 829
 - ["Introduction to :SBUS<n> Commands"](#) on page 755
 - [":SBUS<n>:MODE"](#) on page 759
 - [":SBUS<n>:FLEXray Commands"](#) on page 824

:SBUS<n>:FLEXray:COUNT:TOTal

N (see [page 1384](#))

Query Syntax :SBUS<n>:FLEXray:COUNT:TOTal?

Returns the FlexRay total frame count.

Return Format <frame_count><NL>

<frame_count> ::= integer in NR1 format

Errors • ["-241, Hardware missing"](#) on page 1343

- See Also**
- [":SBUS<n>:FLEXray:COUNT:RESet"](#) on page 830
 - [":SBUS<n>:FLEXray:COUNT:TOTal"](#) on page 832
 - [":SBUS<n>:FLEXray:COUNT:NULL"](#) on page 829
 - [":SBUS<n>:FLEXray:COUNT:SYNC"](#) on page 831
 - ["Introduction to :SBUS<n> Commands"](#) on page 755
 - [":SBUS<n>:MODE"](#) on page 759
 - [":SBUS<n>:FLEXray Commands"](#) on page 824

:SBUS<n>:FLEXray:SOURce

N (see [page 1384](#))

Command Syntax :SBUS<n>:FLEXray:SOURce <source>

<source> ::= {CHANnel<n>}

<n> ::= {1 | 2 | 3 | 4}

The :SBUS<n>:FLEXray:SOURce command specifies the input source for the FlexRay signal.

Query Syntax :SBUS<n>:FLEXray:SOURce?

The :SBUS<n>:FLEXray:SOURce? query returns the current source for the FlexRay signal.

Return Format <source><NL>

- See Also**
- ["Introduction to :TRIGger Commands"](#) on page 1097
 - [":SBUS<n>:FLEXray:TRIGger"](#) on page 834
 - [":SBUS<n>:FLEXray:TRIGger:EVENT:TYPE"](#) on page 838
 - [":SBUS<n>:FLEXray:AUTOsetup"](#) on page 826

:SBUS<n>:FLEXray:TRIGger

N (see [page 1384](#))

Command Syntax :SBUS<n>:FLEXray:TRIGger <condition>
 <condition> ::= {FRAMe | ERRor | EVENT}

The :SBUS<n>:FLEXray:TRIGger:TRIGger command sets the FLEXray trigger on condition:

- FRAMe – triggers on specified frames (without errors).
- ERRor – triggers on selected active error frames and unknown bus conditions.
- EVENT – triggers on specified FlexRay event/symbol.

Query Syntax :SBUS<n>:FLEXray:TRIGger?

The :SBUS<n>:FLEXray:TRIGger? query returns the current FLEXray trigger on condition.

Return Format <condition><NL>
 <condition> ::= {FRAM | ERR | EVEN}

- See Also**
- ["Introduction to :TRIGger Commands"](#) on page 1097
 - [":TRIGger:MODE"](#) on page 1106
 - [":SBUS<n>:FLEXray:TRIGger:ERRor:TYPE"](#) on page 835
 - [":SBUS<n>:FLEXray:TRIGger:EVENT:AUToset"](#) on page 836
 - [":SBUS<n>:FLEXray:TRIGger:EVENT:BSS:ID"](#) on page 837
 - [":SBUS<n>:FLEXray:TRIGger:EVENT:TYPE"](#) on page 838
 - [":SBUS<n>:FLEXray:TRIGger:FRAME:CCBase"](#) on page 839
 - [":SBUS<n>:FLEXray:TRIGger:FRAME:CCRepetition"](#) on page 840
 - [":SBUS<n>:FLEXray:TRIGger:FRAME:ID"](#) on page 841
 - [":SBUS<n>:FLEXray:TRIGger:FRAME:TYPE"](#) on page 842

:SBUS<n>:FLEXray:TRIGger:ERRor:TYPE

N (see [page 1384](#))

Command Syntax :SBUS<n>:FLEXray:TRIGger:ERRor:TYPE <error_type>
 <error_type> ::= {ALL | HCRC | FCRC}

Selects the FlexRay error type to trigger on. The error type setting is only valid when the FlexRay trigger mode is set to ERRor.

- ALL – triggers on ALL errors.
- HCRC – triggers on only Header CRC errors.
- FCRC – triggers on only Frame CRC errors.

Query Syntax :SBUS<n>:FLEXray:TRIGger:ERRor:TYPE?

The :SBUS<n>:FLEXray:TRIGger:ERRor:TYPE? query returns the currently selected FLEXray error type.

Return Format <error_type><NL>

<error_type> ::= {ALL | HCRC | FCRC}

- See Also**
- ["Introduction to :TRIGger Commands"](#) on page 1097
 - [":SBUS<n>:FLEXray:TRIGger"](#) on page 834

:SBUS<n>:FLEXray:TRIGger:EVENT:AUTOset

N (see [page 1384](#))

Command Syntax :SBUS<n>:FLEXray:TRIGger:EVENT:AUTOset

The :SBUS<n>:FLEXray:TRIGger:EVENT:AUTOset command automatically configures oscilloscope settings (as shown on the display) for the selected event trigger.

- See Also**
- ["Introduction to :TRIGger Commands"](#) on page 1097
 - [":SBUS<n>:FLEXray:TRIGger:EVENT:TYPE"](#) on page 838
 - [":SBUS<n>:FLEXray:TRIGger:EVENT:BSS:ID"](#) on page 837
 - [":SBUS<n>:FLEXray:TRIGger"](#) on page 834
 - [":SBUS<n>:FLEXray:BAUDrate"](#) on page 827
 - [":TRIGger\[:EDGE\]:LEVel"](#) on page 1123
 - [":SBUS<n>:FLEXray:SOURce"](#) on page 833

:SBUS<n>:FLEXray:TRIGger:EVENT:BSS:ID

N (see [page 1384](#))

Command Syntax :SBUS<n>:FLEXray:TRIGger:EVENT:BSS:ID <frame_id>

<frame_id> ::= {ALL | <frame #>}

<frame #> ::= integer from 1-2047

The :SBUS<N>:FLEXray:TRIGger:EVENT:BSS:ID command sets the frame ID used by the Byte Start Sequence (BSS) event trigger. This setting is only valid if the trigger mode is EVENT and the EVENT:TYPE is BSS.

Query Syntax :SBUS<n>:FLEXray:TRIGger:EVENT:BSS:ID?

The :SBUS<n>:FLEXray:TRIGger:EVENT:BSS:ID? query returns the current frame ID setting for the Byte Start Sequence (BSS) event trigger setup.

Return Format <frame_id><NL>

<frame_id> ::= {ALL | <frame #>}

<frame #> ::= integer from 1-2047

- See Also**
- ["Introduction to :TRIGger Commands"](#) on page 1097
 - [":SBUS<n>:FLEXray:TRIGger:EVENT:TYPE"](#) on page 838
 - [":SBUS<n>:FLEXray:TRIGger:EVENT:AUToset"](#) on page 836
 - [":TRIGger:MODE"](#) on page 1106
 - [":SBUS<n>:FLEXray:TRIGger"](#) on page 834

:SBUS<n>:FLEXray:TRIGger:EVENT:TYPE

N (see [page 1384](#))

Command Syntax :SBUS<n>:FLEXray:TRIGger:EVENT:TYPE <event>

<event> ::= {WAKEup | TSS | {FES | DTS} | BSS}

Selects the FlexRay event to trigger on. The event setting is only valid when the FlexRay trigger mode is set to EVENT.

- WAKEup – triggers on Wake-Up event.
- TSS – triggers on Transmission Start Sequence event.
- FES – triggers on either Frame End or Dynamic Trailing Sequence event.
- DTS – triggers on either Frame End or Dynamic Trailing Sequence event.
- BSS – triggers on Byte Start Sequence event.

Query Syntax :SBUS<n>:FLEXray:TRIGger:EVENT:TYPE?

The :SBUS<n>:FLEXray:TRIGger:EVENT:TYPE? query returns the currently selected FLEXray event.

Return Format <event><NL>

<event> ::= {WAK | TSS | {FES | DTS} | BSS}

- See Also**
- ["Introduction to :TRIGger Commands"](#) on page 1097
 - [":SBUS<n>:FLEXray:TRIGger:EVENT:AUTOset"](#) on page 836
 - [":SBUS<n>:FLEXray:TRIGger:EVENT:BSS:ID"](#) on page 837
 - [":SBUS<n>:FLEXray:TRIGger"](#) on page 834
 - [":SBUS<n>:FLEXray:AUTOsetup"](#) on page 826
 - [":SBUS<n>:FLEXray:SOURce"](#) on page 833

:SBUS<n>:FLEXray:TRIGger:FRAME:CCBase

N (see [page 1384](#))

Command Syntax :SBUS<n>:FLEXray:TRIGger:FRAME:CCBase <cycle_count_base>
 <cycle_count_base> ::= integer from 0-63

The :SBUS<n>:FLEXray:TRIGger:FRAME:CCBase command sets the base of the FlexRay cycle count (in the frame header) to trigger on. The cycle count base setting is only valid when the FlexRay trigger mode is set to FRAME.

Query Syntax :SBUS<n>:FLEXray:TRIGger:FRAME:CCBase?

The :SBUS<n>:FLEXray:TRIGger:FRAME:CCBase? query returns the current cycle count base setting for the FlexRay frame trigger setup.

Return Format <cycle_count_base><NL>
 <cycle_count_base> ::= integer from 0-63

- See Also**
- ["Introduction to :TRIGger Commands"](#) on page 1097
 - [":SBUS<n>:FLEXray:TRIGger"](#) on page 834

:SBUS<n>:FLEXray:TRIGger:FRAME:CCRepetition

N (see [page 1384](#))

Command Syntax :SBUS<n>:FLEXray:TRIGger:FRAME:CCRepetition <cycle_count_repetition>
 <cycle_count_repetition> ::= {ALL | <rep #>}
 <rep #> ::= integer values 2, 4, 8, 16, 32, or 64

The :SBUS<n>:FLEXray:TRIGger:FRAME:CCRepetition command sets the repetition number of the FlexRay cycle count (in the frame header) to trigger on. The cycle count repetition setting is only valid when the FlexRay trigger mode is set to FRAME.

Query Syntax :SBUS<n>:FLEXray:TRIGger:FRAME:CCRepetition?

The :SBUS<n>:FLEXray:TRIGger:FRAME:CCRepetition? query returns the current cycle count repetition setting for the FlexRay frame trigger setup.

Return Format <cycle_count_repetition><NL>
 <cycle_count_repetition> ::= {ALL | <rep #>}
 <rep #> ::= integer values 2, 4, 8, 16, 32, or 64

- See Also**
- ["Introduction to :TRIGger Commands"](#) on page 1097
 - [":SBUS<n>:FLEXray:TRIGger"](#) on page 834

:SBUS<n>:FLEXray:TRIGger:FRAMe:ID

N (see [page 1384](#))

Command Syntax :SBUS<n>:FLEXray:TRIGger:FRAMe:ID <frame_id>

<frame_id> ::= {ALL | <frame #>}

<frame #> ::= integer from 1-2047

The :SBUS<n>:FLEXray:TRIGger:FRAMe:ID command sets the FlexRay frame ID to trigger on. The frame ID setting is only valid when the FlexRay trigger mode is set to FRAME.

Query Syntax :SBUS<n>:FLEXray:TRIGger:FRAMe:ID?

The :SBUS<n>:FLEXray:TRIGger:FRAMe:ID? query returns the current frame ID setting for the FlexRay frame trigger setup.

Return Format <frame_id><NL>

<frame_id> ::= {ALL | <frame #>}

<frame #> ::= integer from 1-2047

- See Also**
- ["Introduction to :TRIGger Commands"](#) on page 1097
 - [":TRIGger:MODE"](#) on page 1106
 - [":SBUS<n>:FLEXray:TRIGger"](#) on page 834

:SBUS<n>:FLEXray:TRIGger:FRAME:TYPE**N** (see [page 1384](#))**Command Syntax** :SBUS<n>:FLEXray:TRIGger:FRAME:TYPE <frame_type>

<frame_type> ::= {NORMAL | STARTup | NULL | SYNC | NSTArtup | NNULL | NSYNc | ALL}

The :SBUS<n>:FLEXray:TRIGger:FRAME:TYPE command sets the FlexRay frame type to trigger on. The frame type setting is only valid when the FlexRay trigger mode is set to FRAME.

- NORMAL – will trigger on only normal (NSTArtup & NNULL & NSYNc) frames.
- STARTup – will trigger on only startup frames.
- NULL – will trigger on only null frames.
- SYNC – will trigger on only sync frames.
- NSTArtup – will trigger on frames other than startup frames.
- NNULL – will trigger on frames other than null frames.
- NSYNc – will trigger on frames other than sync frames.
- ALL – will trigger on all FlexRay frame types.

Query Syntax :SBUS<n>:FLEXray:TRIGger:FRAME:TYPE?

The :SBUS<n>:FLEXray:TRIGger:FRAME:TYPE? query returns the current frame type setting for the FlexRay frame trigger setup.

Return Format <frame_type><NL>

<frame_type> ::= {NORM | STAR | NULL | SYNC | NSTA | NNUL | NSYN | ALL}

- See Also**
- ["Introduction to :TRIGger Commands"](#) on page 1097
 - ["::TRIGger:MODE"](#) on page 1106
 - ["::SBUS<n>:FLEXray:TRIGger"](#) on page 834

:SBUS<n>:I2S Commands

NOTE

These commands are only valid when the I2S serial decode option (Option SND) has been licensed.

Table 116:SBUS<n>:I2S Commands Summary

Command	Query	Options and Query Returns
:SBUS<n>:I2S:ALIGnment <setting> (see page 845)	:SBUS<n>:I2S:ALIGnment? (see page 845)	<setting> ::= {I2S LJ RJ}
:SBUS<n>:I2S:BASE <base> (see page 846)	:SBUS<n>:I2S:BASE? (see page 846)	<base> ::= {DECimal HEX}
:SBUS<n>:I2S:CLOCK:SLOPe <slope> (see page 847)	:SBUS<n>:I2S:CLOCK:SLOPe? (see page 847)	<slope> ::= {NEGative POSitive}
:SBUS<n>:I2S:RWIDth <receiver> (see page 848)	:SBUS<n>:I2S:RWIDth? (see page 848)	<receiver> ::= 4-32 in NR1 format
:SBUS<n>:I2S:SOURce:CLOCK <source> (see page 849)	:SBUS<n>:I2S:SOURce:CLOCK? (see page 849)	<source> ::= {CHANnel<n> EXTernal} for DSO models <source> ::= {CHANnel<n> DIGital<d>} for MSO models <n> ::= 1 to (# analog channels) in NR1 format <d> ::= 0 to (# digital channels - 1) in NR1 format
:SBUS<n>:I2S:SOURce:DATA <source> (see page 850)	:SBUS<n>:I2S:SOURce:DATA? (see page 850)	<source> ::= {CHANnel<n> EXTernal} for DSO models <source> ::= {CHANnel<n> DIGital<d>} for MSO models <n> ::= 1 to (# analog channels) in NR1 format <d> ::= 0 to (# digital channels - 1) in NR1 format
:SBUS<n>:I2S:SOURce:WSElect <source> (see page 851)	:SBUS<n>:I2S:SOURce:WSElect? (see page 851)	<source> ::= {CHANnel<n> EXTernal} for DSO models <source> ::= {CHANnel<n> DIGital<d>} for MSO models <n> ::= 1 to (# analog channels) in NR1 format <d> ::= 0 to (# digital channels - 1) in NR1 format

Table 116: :SBUS<n>:I2S Commands Summary (continued)

Command	Query	Options and Query Returns
:SBUS<n>:I2S:TRIGger <operator> (see page 852)	:SBUS<n>:I2S:TRIGger? (see page 852)	<operator> ::= {EQUal NOTequal LESSthan GREATERthan INRange OUrRange INCRasing DECRasing}
:SBUS<n>:I2S:TRIGger: AUDio <audio_ch> (see page 854)	:SBUS<n>:I2S:TRIGger: AUDio? (see page 854)	<audio_ch> ::= {RIGHT LEFT EITHer}
:SBUS<n>:I2S:TRIGger: PATtern:DATA <string> (see page 855)	:SBUS<n>:I2S:TRIGger: PATtern:DATA? (see page 856)	<string> ::= "n" where n ::= 32-bit integer in signed decimal when <base> = DECimal <string> ::= "nn...n" where n ::= {0 1 X \$} when <base> = BINary <string> ::= "0xnn...n" where n ::= {0,...,9 A,...,F X \$} when <base> = HEX
:SBUS<n>:I2S:TRIGger: PATtern:FORMat <base> (see page 857)	:SBUS<n>:I2S:TRIGger: PATtern:FORMat? (see page 857)	<base> ::= {BINary HEX DECimal}
:SBUS<n>:I2S:TRIGger: RANGe <lower>,<upper> (see page 858)	:SBUS<n>:I2S:TRIGger: RANGe? (see page 858)	<lower> ::= 32-bit integer in signed decimal, <nondecimal>, or <string> <upper> ::= 32-bit integer in signed decimal, <nondecimal>, or <string> <nondecimal> ::= #Hnn...n where n ::= {0,...,9 A,...,F} for hexadecimal <nondecimal> ::= #Bnn...n where n ::= {0 1} for binary <string> ::= "0xnn...n" where n ::= {0,...,9 A,...,F} for hexadecimal
:SBUS<n>:I2S:TWIDth <word_size> (see page 860)	:SBUS<n>:I2S:TWIDth? (see page 860)	<word_size> ::= 4-32 in NR1 format
:SBUS<n>:I2S:WSLow <low_def> (see page 861)	:SBUS<n>:I2S:WSLow? (see page 861)	<low_def> ::= {LEFT RIGHT}

:SBUS<n>:I2S:ALIGNment

N (see [page 1384](#))

Command Syntax :SBUS<n>:I2S:ALIGNment <setting>

<setting> ::= { I2S | LJ | RJ }

The :SBUS<n>:I2S:ALIGNment command selects the data alignment of the I2S bus for the serial decoder and/or trigger when in I2S mode:

- I2S – standard.
- LJ – left justified.
- RJ – right justified.

Note that the word select (WS) polarity is specified separately with the :SBUS<n>:I2S:WSLow command.

Query Syntax :SBUS<n>:I2S:ALIGNment?

The :SBUS<n>:I2S:ALIGNment? query returns the currently selected I2S data alignment.

Return Format <setting><NL>

<setting> ::= { I2S | LJ | RJ }

- See Also**
- ["Introduction to :TRIGger Commands"](#) on page 1097
 - [":SBUS<n>:I2S:CLOCK:SLOPe"](#) on page 847
 - [":SBUS<n>:I2S:RWIDth"](#) on page 848
 - [":SBUS<n>:I2S:TWIDth"](#) on page 860
 - [":SBUS<n>:I2S:WSLow"](#) on page 861

:SBUS<n>:I2S:BASE

N (see [page 1384](#))

Command Syntax :SBUS<n>:I2S:BASE <base>

<base> ::= {DECimal | HEX}

The :SBUS<n>:I2S:BASE command determines the base to use for the I2S decode display.

Query Syntax :SBUS<n>:I2S:BASE?

The :SBUS<n>:I2S:BASE? query returns the current I2S display decode base.

Return Format <base><NL>

<base> ::= {DECimal | HEX}

Errors • ["-241, Hardware missing"](#) on page 1343

See Also • ["Introduction to :SBUS<n> Commands"](#) on page 755

• [":SBUS<n>:I2S Commands"](#) on page 843

:SBUS<n>:I2S:CLOCK:SLOPe

N (see [page 1384](#))

Command Syntax :SBUS<n>:I2S:CLOCK:SLOPe <slope>
 <slope> ::= {NEGative | POSitive}

The :SBUS<n>:I2S:CLOCK:SLOPe command specifies which edge of the I2S serial clock signal clocks in data.

- NEGative – Falling edge.
- POSitive – Rising edge.

Query Syntax :SBUS<n>:I2S:CLOCK:SLOPe?

The :SBUS<n>:I2S:CLOCK:SLOPe? query returns the current I2S clock slope setting.

Return Format <slope><NL>
 <slope> ::= {NEG | POS}

- See Also**
- ["Introduction to :TRIGger Commands"](#) on page 1097
 - [":SBUS<n>:I2S:ALIGNment"](#) on page 845
 - [":SBUS<n>:I2S:RWIDth"](#) on page 848
 - [":SBUS<n>:I2S:TWIDth"](#) on page 860
 - [":SBUS<n>:I2S:WSLow"](#) on page 861

:SBUS<n>:I2S:RWIDth

N (see [page 1384](#))

Command Syntax :SBUS<n>:I2S:RWIDth <receiver>

<receiver> ::= 4-32 in NR1 format

The :SBUS<n>:I2S:RWIDth command sets the width of the receiver (decoded) data word in I2S anywhere from 4 bits to 32 bits.

Query Syntax :SBUS<n>:I2S:RWIDth?

The :SBUS<n>:I2S:RWIDth? query returns the currently set I2S receiver data word width.

Return Format <receiver><NL>

<receiver> ::= 4-32 in NR1 format

- See Also**
- ["Introduction to :TRIGger Commands"](#) on page 1097
 - [":SBUS<n>:I2S:ALIGNment"](#) on page 845
 - [":SBUS<n>:I2S:CLOCK:SLOPe"](#) on page 847
 - [":SBUS<n>:I2S:TWIDth"](#) on page 860
 - [":SBUS<n>:I2S:WSLow"](#) on page 861

:SBUS<n>:I2S:SOURce:CLOCK

N (see [page 1384](#))

Command Syntax :SBUS<n>:I2S:SOURce:CLOCK <source>

<source> ::= {CHANnel<n> | EXTernal} for the DSO models

<source> ::= {CHANnel<n> | DIGital<d>} for the MSO models

<n> ::= 1 to (# analog channels) in NR1 format

<d> ::= 0 to (# digital channels - 1) in NR1 format

The :SBUS<n>:I2S:SOURce:CLOCK controls which signal is used as the serial clock (SCLK) source by the serial decoder and/or trigger when in I2S mode.

Query Syntax :SBUS<n>:I2S:SOURce:CLOCK?

The :SBUS<n>:I2S:SOURce:CLOCK? query returns the current source for the I2S serial clock (SCLK).

Return Format <source><NL>

- See Also**
- ["Introduction to :TRIGger Commands"](#) on page 1097
 - [":SBUS<n>:I2S:SOURce:DATA"](#) on page 850
 - [":SBUS<n>:I2S:SOURce:WSElect"](#) on page 851

:SBUS<n>:I2S:SOURce:DATA

N (see [page 1384](#))

Command Syntax :SBUS<n>:I2S:SOURce:DATA <source>

<source> ::= {CHANnel<n> | EXTernal} for the DSO models

<source> ::= {CHANnel<n> | DIGital<d>} for the MSO models

<n> ::= 1 to (# analog channels) in NR1 format

<d> ::= 0 to (# digital channels - 1) in NR1 format

The :SBUS<n>:I2S:SOURce:DATA command controls which signal is used as the serial data (SDATA) source by the serial decoder and/or trigger when in I2S mode.

Query Syntax :SBUS<n>:I2S:SOURce:DATA?

The :SBUS<n>:I2S:SOURce:DATA? query returns the current source for the I2S serial data (SDATA).

Return Format <source><NL>

- See Also**
- ["Introduction to :TRIGger Commands"](#) on page 1097
 - [":SBUS<n>:I2S:SOURce:CLOCK"](#) on page 849
 - [":SBUS<n>:I2S:SOURce:WSElect"](#) on page 851

:SBUS<n>:I2S:SOURce:WSElect

N (see [page 1384](#))

Command Syntax :SBUS<n>:I2S:SOURce:WSElect <source>

<source> ::= {CHANnel<n> | EXTernal} for the DSO models

<source> ::= {CHANnel<n> | DIGital<d>} for the MSO models

<n> ::= 1 to (# analog channels) in NR1 format

<d> ::= 0 to (# digital channels - 1) in NR1 format

The :SBUS<n>:I2S:SOURce:WSElect command controls which signal is used as the word select (WS) source by the serial decoder and/or trigger when in I2S mode.

Query Syntax :SBUS<n>:I2S:SOURce:WSElect?

The :SBUS<n>:I2S:SOURce:WSElect? query returns the current source for I2S word select (WS).

Return Format <source><NL>

- See Also**
- ["Introduction to :TRIGger Commands"](#) on page 1097
 - [":SBUS<n>:I2S:SOURce:CLOCK"](#) on page 849
 - [":SBUS<n>:I2S:SOURce:DATA"](#) on page 850

:SBUS<n>:I2S:TRIGger

N (see [page 1384](#))

Command Syntax :SBUS<n>:I2S:TRIGger <operator>

<operator> ::= {EQUal | NOTequal | LESSthan | GREaterthan | INRange
| OUTRange | INCReasing | DECReasing}

The :SBUS<n>:I2S:TRIGger command sets the I2S trigger operator:

- EQUal – triggers on the specified audio channel's data word when it equals the specified word.
- NOTequal – triggers on any word other than the specified word.
- LESSthan – triggers when the channel's data word is less than the specified value.
- GREaterthan – triggers when the channel's data word is greater than the specified value.
- INRange – enter upper and lower values to specify the range in which to trigger.
- OUTRange – enter upper and lower values to specify range in which trigger will not occur.
- INCReasing – triggers when the data value makes a certain increase over time and the specified value is met or exceeded. Use the :SBUS<n>:I2S:TRIGger:RANGe command to set "Trigger" and "Armed" values. The "Trigger" value is the value that must be met or exceeded to cause the trigger. The "Armed" value is the value the data must go below in order to re-arm the oscilloscope (ready it to trigger again).

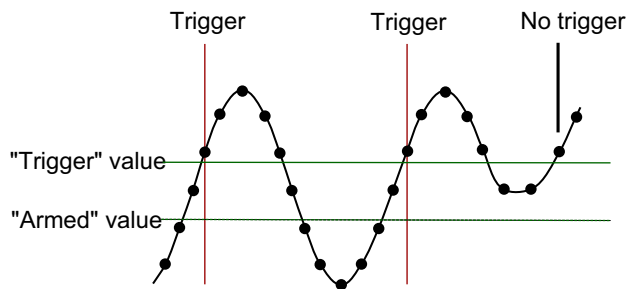

- DECReasing – similar to INCReasing except the trigger occurs on a certain decrease over time and the "Trigger" data value is less than the "Armed" data value.

Query Syntax :SBUS<n>:I2S:TRIGger?

The :SBUS<n>:I2S:TRIGger? query returns the current I2S trigger operator.

Return Format <operator><NL>

<operator> ::= {EQU | NOT | LESS | GRE | INR | OUTR | INCR | DECR}

- See Also**
- ["Introduction to :TRIGger Commands"](#) on page 1097
 - [":SBUS<n>:I2S:TRIGger:AUDio"](#) on page 854
 - [":SBUS<n>:I2S:TRIGger:RANGe"](#) on page 858
 - [":SBUS<n>:I2S:TRIGger:PATTern:FORMat"](#) on page 857

:SBUS<n>:I2S:TRIGger:AUDio

N (see [page 1384](#))

Command Syntax :SBUS<n>:I2S:TRIGger:AUDio <audio_ch>

<audio_ch> ::= {RIGHT | LEFT | EITHER}

The :SBUS<n>:I2S:TRIGger:AUDio command specifies the audio channel to trigger on:

- RIGHT – right channel.
- LEFT – left channel.
- EITHER – right or left channel.

Query Syntax :SBUS<n>:I2S:TRIGger:AUDio?

The :SBUS<n>:I2S:TRIGger:AUDio? query returns the current audio channel for the I2S trigger.

Return Format <audio_ch><NL>

<audio_ch> ::= {RIGH | LEFT | EITH}

- See Also**
- ["Introduction to :TRIGger Commands"](#) on page 1097
 - [":SBUS<n>:I2S:TRIGger"](#) on page 852

:SBUS<n>:I2S:TRIGger:PATtern:DATA

N (see [page 1384](#))

Command Syntax :SBUS<n>:I2S:TRIGger:PATtern:DATA <string>

<string> ::= "n" where n ::= 32-bit integer in signed decimal when
<base> = DECimal

<string> ::= "nn...n" where n ::= {0 | 1 | X | \$} when
<base> = BINary

<string> ::= "0xnn...n" where n ::= {0,...,9 | A,...,F | X | \$} when
<base> = HEX

NOTE

<base> is specified with the :SBUS<n>:I2S:TRIGger:PATtern:FORMat command. The default <base> is DECimal.

The :SBUS<n>:I2S:TRIGger:PATtern:DATA command specifies the I2S trigger data pattern searched for in each I2S message.

Set a <string> bit to "0" or "1" to set the corresponding bit in the data pattern to low or high, respectively.

Set a <string> bit to "X" to ignore (mask off) that bit in the data pattern.

Use the "\$" character to indicate that the value of the corresponding bit will not be changed (the existing bit value is used).

When <base> = DECimal, the "X" and "\$" characters cannot be entered. When queried, the "\$" character is returned when any bits in the pattern have the value of "X" and <base> = DECimal. When any bits in a given nibble have the value of "X" and <base> = HEX, the "\$" character is returned for the corresponding nibble.

NOTE

The :SBUS<n>:I2S:TRIGger:PATtern:DATA command specifies the I2S trigger data pattern used by the EQUal, NOTequal, GREaterthan, and LESSthan trigger conditions. If the GREaterthan or LESSthan trigger condition is selected, the bits specified to be masked off ("X") will be interpreted as 0's.

NOTE

The length of the trigger data value is determined by the :SBUS<n>:I2S:RWIDth and :SBUS<n>:I2S:TWIDth commands. When the receiver word size is less than the transmitter word size, the data length is equal to the receiver word size. When the receiver word size is greater than the transmitter word size, the data length is equal to the transmitter word size.

NOTE

If more bits are sent for <string> than the specified trigger data length, the most significant bits will be truncated. If the word size is changed after the <string> is programmed, the added or deleted bits will be added to or deleted from the least significant bits.

Query Syntax :SBUS<n>:I2S:TRIGger:PATtern:DATA?

The :SBUS<n>:I2S:TRIGger:PATtern:DATA? query returns the currently specified I2S trigger data pattern.

Return Format <string><NL>

- See Also**
- ["Introduction to :TRIGger Commands"](#) on page 1097
 - [":SBUS<n>:I2S:TRIGger:PATtern:FORMat"](#) on page 857
 - [":SBUS<n>:I2S:TRIGger"](#) on page 852
 - [":SBUS<n>:I2S:RWIDth"](#) on page 848
 - [":SBUS<n>:I2S:TWIDth"](#) on page 860
 - [":SBUS<n>:I2S:TRIGger:AUDio"](#) on page 854

:SBUS<n>:I2S:TRIGger:PATtern:FORMat

N (see [page 1384](#))

Command Syntax :SBUS<n>:I2S:TRIGger:PATtern:FORMat <base>

<base> ::= {BINary | HEX | DECimal}

The :SBUS<n>:I2S:TRIGger:PATtern:FORMat command sets the entry (and query) number base used by the :SBUS<n>:I2S:TRIGger:PATtern:DATA command. The default <base> is DECimal.

Query Syntax :SBUS<n>:I2S:TRIGger:PATtern:FORMat?

The :SBUS<n>:I2S:TRIGger:PATtern:FORMat? query returns the currently set number base for I2S pattern data.

Return Format <base><NL>

<base> ::= {BIN | HEX | DEC}

- See Also**
- ["Introduction to :TRIGger Commands"](#) on page 1097
 - [":SBUS<n>:I2S:TRIGger:AUDio"](#) on page 854
 - [":SBUS<n>:I2S:TRIGger"](#) on page 852

:SBUS<n>:I2S:TRIGger:RANGe**N** (see [page 1384](#))

Command Syntax :SBUS<n>:I2S:TRIGger:RANGe <lower>,<upper>

<lower> ::= 32-bit integer in signed decimal, <nondecimal>
or <string>

<upper> ::= 32-bit integer in signed decimal, <nondecimal>,
or <string>

<nondecimal> ::= #Hnn...n where n ::= {0,...,9 | A,...,F}
for hexadecimal

<nondecimal> ::= #Bnn...n where n ::= {0 | 1} for binary

<string> ::= "0xnn...n" where n ::= {0,...,9 | A,...,F} for hexadecimal

The :SBUS<n>:I2S:TRIGger:RANGe command sets the lower and upper range boundaries used by the INRange, OUTRange, INCReasing, and DECReasing trigger conditions. You can enter the parameters in any order – the smaller value becomes the <lower> and the larger value becomes the <upper>.

Note that for INCReasing and DECReasing, the <lower> and <upper> values correspond to the "Armed" and "Trigger" softkeys.

NOTE

The length of the <lower> and <upper> values is determined by the :SBUS<n>:I2S:RWIDth and :SBUS<n>:I2S:TWIDth commands. When the receiver word size is less than the transmitter word size, the length is equal to the receiver word size. When the receiver word size is greater than the transmitter word size, the length is equal to the transmitter word size.

Query Syntax :SBUS<n>:I2S:TRIGger:RANGe?

The :SBUS<n>:I2S:TRIGger:RANGe? query returns the currently set lower and upper range boundaries.

Return Format <lower>,<upper><NL>

<lower> ::= 32-bit integer in signed decimal, <nondecimal>
or <string>

<upper> ::= 32-bit integer in signed decimal, <nondecimal>,
or <string>

<nondecimal> ::= #Hnn...n where n ::= {0,...,9 | A,...,F}
for hexadecimal

<nondecimal> ::= #Bnn...n where n ::= {0 | 1} for binary

<string> ::= "0xnn...n" where n ::= {0,...,9 | A,...,F} for hexadecimal

- See Also**
- ["Introduction to :TRIGger Commands"](#) on page 1097
 - [":SBUS<n>:I2S:TRIGger"](#) on page 852
 - [":SBUS<n>:I2S:RWIDth"](#) on page 848

- `":SBUS<n>:I2S:TWIDth"` on page 860
- `":SBUS<n>:I2S:WSLow"` on page 861

:SBUS<n>:I2S:TWIDth

N (see [page 1384](#))

Command Syntax :SBUS<n>:I2S:TWIDth <word_size>

<word_size> ::= 4-32 in NR1 format

The :SBUS<n>:I2S:TWIDth command sets the width of the transmitted data word in I2S anywhere from 4 bits to 32 bits.

Query Syntax :SBUS<n>:I2S:TWIDth?

The :SBUS<n>:I2S:TWIDth? query returns the currently set I2S transmitted data word width.

Return Format <word_size><NL>

<word_size> ::= 4-32 in NR1 format

- See Also**
- ["Introduction to :TRIGger Commands"](#) on page 1097
 - [":SBUS<n>:I2S:ALIGNment"](#) on page 845
 - [":SBUS<n>:I2S:CLOCK:SLOPe"](#) on page 847
 - [":SBUS<n>:I2S:RWIDth"](#) on page 848
 - [":SBUS<n>:I2S:WSLow"](#) on page 861

:SBUS<n>:I2S:WSLow

N (see [page 1384](#))

Command Syntax :SBUS<n>:I2S:WSLow <low_def>

<low_def> ::= {LEFT | RIGHT}

The :SBUS<n>:I2S:WSLow command selects the polarity of the word select (WS) signal:

- LEFT— a word select (WS) state of low indicates left channel data is active on the I2S bus, and a WS state of high indicates right channel data is active on the bus.
- RIGHT — a word select (WS) state of low indicates right channel data is active on the I2S bus, and a WS state of high indicates left channel data is active on the bus.

Query Syntax :SBUS<n>:I2S:WSLow?

The :SBUS<n>:I2S:WSLow? query returns the currently selected I2S word select (WS) polarity.

Return Format <low_def><NL>

<low_def> ::= {LEFT | RIGHT}

- See Also**
- ["Introduction to :TRIGger Commands"](#) on page 1097
 - [":SBUS<n>:I2S:ALIGNment"](#) on page 845
 - [":SBUS<n>:I2S:CLOCK:SLOPe"](#) on page 847
 - [":SBUS<n>:I2S:RWIDth"](#) on page 848
 - [":SBUS<n>:I2S:TWIDth"](#) on page 860

:SBUS<n>:IIC Commands

NOTE

These commands are only valid when the low-speed IIC and SPI serial decode option (Option LSS) has been licensed.

Table 117 :SBUS<n>:IIC Commands Summary

Command	Query	Options and Query Returns
:SBUS<n>:IIC:ASIZE <size> (see page 863)	:SBUS<n>:IIC:ASIZE? (see page 863)	<size> ::= {BIT7 BIT8}
:SBUS<n>:IIC[:SOURce] :CLOCK <source> (see page 864)	:SBUS<n>:IIC[:SOURce] :CLOCK? (see page 864)	<source> ::= {CHANnel<n> EXTErnal} for DSO models <source> ::= {CHANnel<n> DIGital<d>} for MSO models <n> ::= 1 to (# analog channels) in NR1 format <d> ::= 0 to (# digital channels - 1) in NR1 format
:SBUS<n>:IIC[:SOURce] :DATA <source> (see page 865)	:SBUS<n>:IIC[:SOURce] :DATA? (see page 865)	<source> ::= {CHANnel<n> EXTErnal} for DSO models <source> ::= {CHANnel<n> DIGital<d>} for MSO models <n> ::= 1 to (# analog channels) in NR1 format <d> ::= 0 to (# digital channels - 1) in NR1 format
:SBUS<n>:IIC:TRIGger: PATTErn:ADDREss <value> (see page 866)	:SBUS<n>:IIC:TRIGger: PATTErn:ADDREss? (see page 866)	<value> ::= integer or <string> <string> ::= "0xnn" n ::= {0,...,9 A,...,F}
:SBUS<n>:IIC:TRIGger: PATTErn:DATA <value> (see page 867)	:SBUS<n>:IIC:TRIGger: PATTErn:DATA? (see page 867)	<value> ::= integer or <string> <string> ::= "0xnn" n ::= {0,...,9 A,...,F}
:SBUS<n>:IIC:TRIGger: PATTErn:DATA2 <value> (see page 868)	:SBUS<n>:IIC:TRIGger: PATTErn:DATA2? (see page 868)	<value> ::= integer or <string> <string> ::= "0xnn" n ::= {0,...,9 A,...,F}
:SBUS<n>:IIC:TRIGger: QUALifier <value> (see page 869)	:SBUS<n>:IIC:TRIGger: QUALifier? (see page 869)	<value> ::= {EQUal NOTequal LESSthan GREATERthan}
:SBUS<n>:IIC:TRIGger[:TYPE] <type> (see page 870)	:SBUS<n>:IIC:TRIGger[:TYPE]? (see page 870)	<type> ::= {START STOP READ7 READEprom WRITe7 WRITe10 NACKnowledge ANACK R7Data2 W7Data2 REStart}

:SBUS<n>:IIC:ASIZe

N (see [page 1384](#))

Command Syntax :SBUS<n>:IIC:ASIZe <size>
 <size> ::= {BIT7 | BIT8}

The :SBUS<n>:IIC:ASIZe command determines whether the Read/Write bit is included as the LSB in the display of the IIC address field of the decode bus.

Query Syntax :SBUS<n>:IIC:ASIZe?

The :SBUS<n>:IIC:ASIZe? query returns the current IIC address width setting.

Return Format <mode><NL>
 <mode> ::= {BIT7 | BIT8}

Errors • ["-241, Hardware missing"](#) on page 1343

See Also • ["Introduction to :SBUS<n> Commands"](#) on page 755
 • [":SBUS<n>:IIC Commands"](#) on page 862

:SBUS<n>:IIC[:SOURce]:CLOCK

N (see [page 1384](#))

Command Syntax :SBUS<n>:IIC:[SOURce:]CLOCK <source>

<source> ::= {CHANnel<n> | EXTernal} for the DSO models

<source> ::= {CHANnel<n> | DIGital<d>} for the MSO models

<n> ::= 1 to (# analog channels) in NR1 format

<d> ::= 0 to (# digital channels - 1) in NR1 format

The :SBUS<n>:IIC:[SOURce:]CLOCK command sets the source for the IIC serial clock (SCL).

Query Syntax :SBUS<n>:IIC:[SOURce:]CLOCK?

The :SBUS<n>:IIC:[SOURce:]CLOCK? query returns the current source for the IIC serial clock.

Return Format <source><NL>

- See Also**
- ["Introduction to :TRIGger Commands"](#) on page 1097
 - [":SBUS<n>:IIC\[:SOURce\]:DATA"](#) on page 865

:SBUS<n>:IIC[:SOURce]:DATA

N (see [page 1384](#))

Command Syntax :SBUS<n>:IIC:[SOURce:]DATA <source>

<source> ::= {CHANnel<n> | EXTernal} for the DSO models

<source> ::= {CHANnel<n> | DIGital<d>} for the MSO models

<n> ::= 1 to (# analog channels) in NR1 format

<d> ::= 0 to (# digital channels - 1) in NR1 format

The :SBUS<n>:IIC:[SOURce:]DATA command sets the source for IIC serial data (SDA).

Query Syntax :SBUS<n>:IIC:[SOURce:]DATA?

The :SBUS<n>:IIC:[SOURce:]DATA? query returns the current source for IIC serial data.

Return Format <source><NL>

- See Also**
- ["Introduction to :TRIGger Commands"](#) on page 1097
 - [":SBUS<n>:IIC\[:SOURce\]:CLOCK"](#) on page 864

:SBUS<n>:IIC:TRIGger:PATtern:ADDRes

N (see [page 1384](#))

Command Syntax :SBUS<n>:IIC:TRIGger:PATtern:ADDRes <value>

<value> ::= integer or <string>

<string> ::= "0xnn" where n ::= {0,...,9 | A,...,F}

The :SBUS<n>:IIC:TRIGger:PATtern:ADDRes command sets the address for IIC data. The address can range from 0x00 to 0x7F (7-bit) or 0x3FF (10-bit) hexadecimal. Use the don't care address (-1 or 0xFFFFFFFF) to ignore the address value.

Query Syntax :SBUS<n>:IIC:TRIGger:PATtern:ADDRes?

The :SBUS<n>:IIC:TRIGger:PATtern:ADDRes? query returns the current address for IIC data.

Return Format <value><NL>

<value> ::= integer

- See Also**
- ["Introduction to :TRIGger Commands"](#) on page 1097
 - [":SBUS<n>:IIC:TRIGger:PATtern:DATA"](#) on page 867
 - [":SBUS<n>:IIC:TRIGger:PATtern:DATA2"](#) on page 868
 - [":SBUS<n>:IIC:TRIGger\[:TYPE\]"](#) on page 870

:SBUS<n>:IIC:TRIGger:PATtern:DATA

N (see [page 1384](#))

Command Syntax :SBUS<n>:IIC:TRIGger:PATtern:DATA <value>

<value> ::= integer or <string>

<string> ::= "0xnn" where n ::= {0,...,9 | A,...,F}

The :SBUS<n>:IIC:TRIGger:PATtern:DATA command sets IIC data. The data value can range from 0x00 to 0xFF (hexadecimal). Use the don't care data pattern (-1 or 0xFFFFFFFF) to ignore the data value.

Query Syntax :SBUS<n>:IIC:TRIGger:PATtern:DATA?

The :SBUS<n>:IIC:TRIGger:PATtern:DATA? query returns the current pattern for IIC data.

Return Format <value><NL>

- See Also**
- ["Introduction to :TRIGger Commands"](#) on page 1097
 - [":SBUS<n>:IIC:TRIGger:PATtern:ADDRess"](#) on page 866
 - [":SBUS<n>:IIC:TRIGger:PATtern:DATA2"](#) on page 868
 - [":SBUS<n>:IIC:TRIGger\[:TYPE\]"](#) on page 870

:SBUS<n>:IIC:TRIGger:PATtern:DATA2

N (see [page 1384](#))

Command Syntax :SBUS<n>:IIC:TRIGger:PATtern:DATA2 <value>

<value> ::= integer or <string>

<string> ::= "0xnn" where n ::= {0,...,9 | A,...,F}

The :SBUS<n>:IIC:TRIGger:PATtern:DATA2 command sets IIC data 2. The data value can range from 0x00 to 0xFF (hexadecimal). Use the don't care data pattern (-1 or 0xFFFFFFFF) to ignore the data value.

Query Syntax :SBUS<n>:IIC:TRIGger:PATtern:DATA2?

The :SBUS<n>:IIC:TRIGger:PATtern:DATA2? query returns the current pattern for IIC data 2.

Return Format <value><NL>

- See Also**
- ["Introduction to :TRIGger Commands"](#) on page 1097
 - [":SBUS<n>:IIC:TRIGger:PATtern:ADDRESS"](#) on page 866
 - [":SBUS<n>:IIC:TRIGger:PATtern:DATA"](#) on page 867
 - [":SBUS<n>:IIC:TRIGger\[:TYPE\]"](#) on page 870

:SBUS<n>:IIC:TRIGger:QUALifier

N (see [page 1384](#))

Command Syntax :SBUS<n>:IIC:TRIGger:QUALifier <value>

<value> ::= {EQUal | NOTequal | LESSthan | GREATERthan}

The :SBUS<n>:IIC:TRIGger:QUALifier command sets the IIC data qualifier when TRIGger:IIC:TRIGger[:TYPE] is set to READEprom.

Query Syntax :SBUS<n>:IIC:TRIGger:QUALifier?

The :SBUS<n>:IIC:TRIGger:QUALifier? query returns the current IIC data qualifier value.

Return Format <value><NL>

<value> ::= {EQUal | NOTequal | LESSthan | GREATERthan}

- See Also**
- ["Introduction to :TRIGger Commands"](#) on page 1097
 - [":TRIGger:MODE"](#) on page 1106
 - [":SBUS<n>:IIC:TRIGger\[:TYPE\]"](#) on page 870

:SBUS<n>:IIC:TRIGger[:TYPE]**N** (see [page 1384](#))**Command Syntax** :SBUS<n>:IIC:TRIGger[:TYPE] <value>

```
<value> ::= {START | STOP | READ7 | READEprom | WRITe7 | WRITe10
| NACKnowledge | ANACK | R7Data2 | W7Data2 | REStart}
```

The :SBUS<n>:IIC:TRIGger[:TYPE] command sets the IIC trigger type:

- START – Start condition.
- STOP – Stop condition.
- READ7 – 7-bit address frame containing (Start:Address7:Read:Ack:Data). The value READ is also accepted for READ7.
- R7Data2 – 7-bit address frame containing (Start:Address7:Read:Ack:Data:Ack:Data2).
- READEprom – EEPROM data read.
- WRITe7 – 7-bit address frame containing (Start:Address7:Write:Ack:Data). The value WRITe is also accepted for WRITe7.
- W7Data2 – 7-bit address frame containing (Start:Address7:Write:Ack:Data:Ack:Data2).
- WRITe10 – 10-bit address frame containing (Start:Address byte1:Write:Ack:Address byte 2:Data).
- NACKnowledge – Missing acknowledge.
- ANACK – Address with no acknowledge.
- REStart – Another start condition occurs before a stop condition.

NOTE

The short form of READ7 (READ7), READEprom (READE), WRITe7 (WRIT7), and WRITe10 (WRIT10) do not follow the defined Long Form to Short Form Truncation Rules (see [page 1386](#)).

Query Syntax :SBUS<n>:IIC:TRIGger[:TYPE] ?

The :SBUS<n>:IIC:TRIGger[:TYPE]? query returns the current IIC trigger type value.

Return Format <value><NL>

```
<value> ::= {STAR | STOP | READ7 | READE | WRIT7 | WRIT10 | NACK | ANAC
| R7D2 | W7D2 | REST}
```

- See Also**
- ["Introduction to :TRIGger Commands"](#) on page 1097
 - [":TRIGger:MODE"](#) on page 1106
 - [":SBUS<n>:IIC:TRIGger:PATtern:ADDReSS"](#) on page 866
 - [":SBUS<n>:IIC:TRIGger:PATtern:DATA"](#) on page 867

- [":SBUS<n>:IIC:TRIGger:PATtern:DATa2"](#) on page 868
- [":SBUS<n>:IIC:TRIGger:QUALifier"](#) on page 869
- ["Long Form to Short Form Truncation Rules"](#) on page 1386

:SBUS<n>:LIN Commands

NOTE

These commands are valid when the automotive CAN and LIN serial decode option (Option AMS) has been licensed.

Table 118: :SBUS<n>:LIN Commands Summary

Command	Query	Options and Query Returns
:SBUS<n>:LIN:DISPlay <type> (see page 874)	:SBUS<n>:LIN:DISPlay? (see page 874)	<type> ::= {HEXadecimal SYMBOLic}
:SBUS<n>:LIN:PARity { {0 OFF} {1 ON} } (see page 875)	:SBUS<n>:LIN:PARity? (see page 875)	{0 1}
:SBUS<n>:LIN:SAMPlepo int <value> (see page 876)	:SBUS<n>:LIN:SAMPlepo int? (see page 876)	<value> ::= {60 62.5 68 70 75 80 87.5} in NR3 format
:SBUS<n>:LIN:SIGNAL:B AUDrate <baudrate> (see page 877)	:SBUS<n>:LIN:SIGNAL:B AUDrate? (see page 877)	<baudrate> ::= integer from 2400 to 625000 in 100 b/s increments
:SBUS<n>:LIN:SOURce <source> (see page 878)	:SBUS<n>:LIN:SOURce? (see page 878)	<source> ::= {CHANnel<n> EXTernal} for DSO models <source> ::= {CHANnel<n> DIGital<d>} for MSO models <n> ::= 1 to (# analog channels) in NR1 format <d> ::= 0 to (# digital channels - 1) in NR1 format
:SBUS<n>:LIN:STANdard <std> (see page 879)	:SBUS<n>:LIN:STANdard ? (see page 879)	<std> ::= {LIN13 LIN13NLC LIN20}
:SBUS<n>:LIN:SYNCbrea k <value> (see page 880)	:SBUS<n>:LIN:SYNCbrea k? (see page 880)	<value> ::= integer = {11 12 13}
:SBUS<n>:LIN:TRIGger <condition> (see page 881)	:SBUS<n>:LIN:TRIGger? (see page 881)	<condition> ::= {SYNCbreak ID DATA}

Table 118: :SBUS<n>:LIN Commands Summary (continued)

Command	Query	Options and Query Returns
:SBUS<n>:LIN:TRIGger:ID <value> (see page 882)	:SBUS<n>:LIN:TRIGger:ID? (see page 882)	<value> ::= 7-bit integer in decimal, <nondecimal>, or <string> from 0-63 or 0x00-0x3f <nondecimal> ::= #Hnn where n ::= {0,...,9 A,...,F} for hexadecimal <nondecimal> ::= #Bnn...n where n ::= {0 1} for binary <string> ::= "0xnn" where n ::= {0,...,9 A,...,F} for hexadecimal
:SBUS<n>:LIN:TRIGger:PATtern:DATA <string> (see page 883)	:SBUS<n>:LIN:TRIGger:PATtern:DATA? (see page 883)	<string> ::= "n" where n ::= 32-bit integer in unsigned decimal when <base> = DECimal <string> ::= "nn...n" where n ::= {0 1 X \$} when <base> = BINary <string> ::= "0xnn...n" where n ::= {0,...,9 A,...,F X \$} when <base> = HEX
:SBUS<n>:LIN:TRIGger:PATtern:DATA:LENGth <length> (see page 885)	:SBUS<n>:LIN:TRIGger:PATtern:DATA:LENGth? (see page 885)	<length> ::= integer from 1 to 8 in NR1 format
:SBUS<n>:LIN:TRIGger:PATtern:FORMat <base> (see page 886)	:SBUS<n>:LIN:TRIGger:PATtern:FORMat? (see page 886)	<base> ::= {BINary HEX DECimal}
:SBUS<n>:LIN:TRIGger:SYMBolic:FRAMe <name> (see page 887)	:SBUS<n>:LIN:TRIGger:SYMBolic:FRAMe? (see page 887)	<name> ::= quoted ASCII string
:SBUS<n>:LIN:TRIGger:SYMBolic:SIGNal <name> (see page 888)	:SBUS<n>:LIN:TRIGger:SYMBolic:SIGNal? (see page 888)	<name> ::= quoted ASCII string
:SBUS<n>:LIN:TRIGger:SYMBolic:VALue <data> (see page 889)	:SBUS<n>:LIN:TRIGger:SYMBolic:VALue? (see page 889)	<data> ::= value in NR3 format

:SBUS<n>:LIN:DISPlay

N (see [page 1384](#))

Command Syntax :SBUS<n>:LIN:DISPlay <type>

<type> ::= {HEXadecimal | SYMBolic}

The :SBUS<n>:LIN:DISPlay command specifies, when LIN symbolic data is loaded into the oscilloscope, whether symbolic values (from the LDF file) or hexadecimal values are displayed in the decode waveform and the Lister window.

Query Syntax :SBUS<n>:LIN:DISPlay?

The :SBUS<n>:LIN:DISPlay? query returns the LIN decode display type.

Return Format <type><NL>

<type> ::= {HEX | SYMB}

See Also • [":RECall:LDF\[:START\]"](#) on page 720

:SBUS<n>:LIN:PARity

N (see [page 1384](#))

Command Syntax :SBUS<n>:LIN:PARity <display>

<display> ::= {{1 | ON} | {0 | OFF}}

The :SBUS<n>:LIN:PARity command determines whether the parity bits are included as the most significant bits (MSB) in the display of the Frame Id field in the LIN decode bus.

Query Syntax :SBUS<n>:LIN:PARity?

The :SBUS<n>:LIN:PARity? query returns the current LIN parity bits display setting of the serial decode bus.

Return Format <display><NL>

<display> ::= {0 | 1}

Errors • ["-241, Hardware missing"](#) on page 1343

See Also • ["Introduction to :SBUS<n> Commands"](#) on page 755
• [":SBUS<n>:LIN Commands"](#) on page 872

:SBUS<n>:LIN:SAMPlEpoint

N (see [page 1384](#))

Command Syntax :SBUS<n>:LIN:SAMPlEpoint <value>

<value><NL>

<value> ::= {60 | 62.5 | 68 | 70 | 75 | 80 | 87.5} in NR3 format

The :SBUS<n>:LIN:SAMPlEpoint command sets the point during the bit time where the bit level is sampled to determine whether the bit is dominant or recessive. The sample point represents the percentage of time between the beginning of the bit time to the end of the bit time.

NOTE

The sample point values are not limited by the baud rate.

Query Syntax :SBUS<n>:LIN:SAMPlEpoint?

The :SBUS<n>:LIN:SAMPlEpoint? query returns the current LIN sample point setting.

Return Format <value><NL>

<value> ::= {60 | 62.5 | 68 | 70 | 75 | 80 | 87.5} in NR3 format

- See Also**
- ["Introduction to :TRIGger Commands"](#) on page 1097
 - [":TRIGger:MODE"](#) on page 1106
 - [":SBUS<n>:LIN:TRIGger"](#) on page 881

:SBUS<n>:LIN:SIGNal:BAUDrate

N (see [page 1384](#))

Command Syntax :SBUS<n>:LIN:SIGNal:BAUDrate <baudrate>

<baudrate> ::= integer from 2400 to 625000 in 100 b/s increments

The :SBUS<n>:LIN:SIGNal:BAUDrate command sets the standard baud rate of the LIN signal from 2400 b/s to 625 kb/s in 100 b/s increments. If you enter a baud rate that is not divisible by 100 b/s, the baud rate is set to the nearest baud rate divisible by 100 b/s.

Query Syntax :SBUS<n>:LIN:SIGNal:BAUDrate?

The :SBUS<n>:LIN:SIGNal:BAUDrate? query returns the current LIN baud rate setting.

Return Format <baudrate><NL>

<baudrate> ::= integer from 2400 to 625000 in 100 b/s increments

- See Also**
- ["Introduction to :TRIGger Commands"](#) on page 1097
 - [":TRIGger:MODE"](#) on page 1106
 - [":SBUS<n>:LIN:TRIGger"](#) on page 881
 - [":SBUS<n>:LIN:SIGNal:DEFinition"](#) on page 1334
 - [":SBUS<n>:LIN:SOURce"](#) on page 878

:SBUS<n>:LIN:SOURce

N (see [page 1384](#))

Command Syntax :SBUS<n>:LIN:SOURce <source>

<source> ::= {CHANnel<n> | EXTernal} for the DSO models

<source> ::= {CHANnel<n> | DIGital<d>} for the MSO models

<n> ::= 1 to (# analog channels) in NR1 format

<d> ::= 0 to (# digital channels - 1) in NR1 format

The :SBUS<n>:LIN:SOURce command sets the source for the LIN signal.

Query Syntax :SBUS<n>:LIN:SOURce?

The :SBUS<n>:LIN:SOURce? query returns the current source for the LIN signal.

Return Format <source><NL>

- See Also**
- ["Introduction to :TRIGger Commands"](#) on page 1097
 - [":TRIGger:MODE"](#) on page 1106
 - [":SBUS<n>:LIN:TRIGger"](#) on page 881
 - [":SBUS<n>:LIN:SIGNal:DEFinition"](#) on page 1334

:SBUS<n>:LIN:STANdard

N (see [page 1384](#))

Command Syntax :SBUS<n>:LIN:STANdard <std>

<std> ::= {LIN13 | LIN13NLC | LIN20}

The :SBUS<n>:LIN:STANdard command sets the LIN standard in effect for triggering and decoding:

- LIN13 – LIN 1.3.
- LIN13NLC – LIN 1.3 (no length control). Select this for systems where length control is not used and all nodes have knowledge of the data packet size. In LIN 1.3, the ID may or may not be used to indicate the number of bytes. (In LIN 2.X, there is no length control.)
- LIN20 – LIN 2.X.

For LIN 1.2 signals, use the LIN 1.3 setting. The LIN 1.3 setting assumes the signal follows the "Table of Valid ID Values" as shown in section A.2 of the LIN Specification dated December 12, 2002. If your signal does not comply with the table, use the LIN 2.X setting.

Query Syntax :SBUS<n>:LIN:STANdard?

The :SBUS<n>:LIN:STANdard? query returns the current LIN standard setting.

Return Format <std><NL>

<std> ::= {LIN13 | LIN13NLC | LIN20}

- See Also**
- ["Introduction to :TRIGger Commands"](#) on page 1097
 - [":TRIGger:MODE"](#) on page 1106
 - [":SBUS<n>:LIN:SIGNal:DEFinition"](#) on page 1334
 - [":SBUS<n>:LIN:SOURce"](#) on page 878

:SBUS<n>:LIN:SYNCbreak

N (see [page 1384](#))

Command Syntax :SBUS<n>:LIN:SYNCbreak <value>

<value> ::= integer = {11 | 12 | 13}

The :SBUS<n>:LIN:SYNCbreak command sets the length of the LIN sync break to be greater than or equal to 11, 12, or 13 clock lengths. The sync break is the idle period in the bus activity at the beginning of each packet that distinguishes one information packet from the previous one.

Query Syntax :SBUS<n>:LIN:SYNCbreak?

The :SBUS<n>:LIN:SYNCbreak? query returns the current LIN sync break setting.

Return Format <value><NL>

<value> ::= {11 | 12 | 13}

- See Also**
- ["Introduction to :TRIGger Commands"](#) on page 1097
 - [":TRIGger:MODE"](#) on page 1106
 - [":SBUS<n>:LIN:SIGNal:DEFinition"](#) on page 1334
 - [":SBUS<n>:LIN:SOURce"](#) on page 878

:SBUS<n>:LIN:TRIGger

N (see [page 1384](#))

Command Syntax :SBUS<n>:LIN:TRIGger <condition>

```
<condition> ::= {SYNCbreak | ID | DATA | PARityerror | CSUMerror
                | FRAME | FSIgnal}
```

The :SBUS<n>:LIN:TRIGger command sets the LIN trigger condition to be:

- SYNCbreak – Sync Break.
- ID – Frame ID.

Use the :SBUS<n>:LIN:TRIGger:ID command to specify the frame ID.

- DATA – Frame ID and Data.

Use the :SBUS<n>:LIN:TRIGger:ID command to specify the frame ID.

Use the :SBUS<n>:LIN:TRIGger:PATTern:DATA:LENGth and :SBUS<n>:LIN:TRIGger:PATTern:DATA commands to specify the data string length and value.

- PARityerror – parity errors.
- CSUMerror – checksum errors.
- FRAME – Triggers on a symbolic frame.
- FSIgnal – Triggers on a symbolic frame and a signal value.

Query Syntax :SBUS<n>:LIN:TRIGger?

The :SBUS<n>:LIN:TRIGger? query returns the current LIN trigger value.

Return Format <condition><NL>

```
<condition> ::= {SYNC | ID | DATA | PAR | CSUM | FRAM | FSIgn}
```

Errors • ["-241, Hardware missing"](#) on page 1343

- See Also**
- ["Introduction to :TRIGger Commands"](#) on page 1097
 - [":TRIGger:MODE"](#) on page 1106
 - [":SBUS<n>:LIN:TRIGger:ID"](#) on page 882
 - [":SBUS<n>:LIN:TRIGger:PATTern:DATA:LENGth"](#) on page 885
 - [":SBUS<n>:LIN:TRIGger:PATTern:DATA"](#) on page 883
 - [":SBUS<n>:LIN:SIGNal:DEFinition"](#) on page 1334
 - [":SBUS<n>:LIN:SOURce"](#) on page 878
 - [":RECall:LDF\[:START\]"](#) on page 720
 - [":SBUS<n>:LIN:TRIGger:SYMBolic:FRAME"](#) on page 887
 - [":SBUS<n>:LIN:TRIGger:SYMBolic:SIGNal"](#) on page 888
 - [":SBUS<n>:LIN:TRIGger:SYMBolic:VALue"](#) on page 889

:SBUS<n>:LIN:TRIGger:ID

N (see [page 1384](#))

Command Syntax :SBUS<n>:LIN:TRIGger:ID <value>

<value> ::= 7-bit integer in decimal, <nondecimal>, or <string>
from 0-63 or 0x00-0x3f

<nondecimal> ::= #Hnn where n ::= {0,...,9 | A,...,F} for hexadecimal

<nondecimal> ::= #Bnn...n where n ::= {0 | 1} for binary

<string> ::= "0xnn" where n ::= {0,...,9 | A,...,F} for hexadecimal

The :SBUS<n>:LIN:TRIGger:ID command defines the LIN identifier searched for in each CAN message when the LIN trigger mode is set to frame ID.

Setting the ID to a value of "-1" results in "0xXX" which is equivalent to all IDs.

Query Syntax :SBUS<n>:LIN:TRIGger:ID?

The :SBUS<n>:LIN:TRIGger:ID? query returns the current LIN identifier setting.

Return Format <value><NL>

<value> ::= integer in decimal

Errors • ["-241, Hardware missing"](#) on page 1343

See Also • ["Introduction to :TRIGger Commands"](#) on page 1097

• [":TRIGger:MODE"](#) on page 1106

• [":SBUS<n>:LIN:TRIGger"](#) on page 881

• [":SBUS<n>:LIN:SIGNal:DEFinition"](#) on page 1334

• [":SBUS<n>:LIN:SOURce"](#) on page 878

:SBUS<n>:LIN:TRIGger:PATtern:DATA

N (see [page 1384](#))

Command Syntax :SBUS<n>:LIN:TRIGger:PATtern:DATA <string>

<string> ::= "n" where n ::= 32-bit integer in unsigned decimal when
<base> = DECimal

<string> ::= "nn...n" where n ::= {0 | 1 | X | \$} when
<base> = BINary

<string> ::= "0xnn...n" where n ::= {0,...,9 | A,...,F | X | \$} when
<base> = HEX

NOTE

<base> is specified with the :SBUS<n>:LIN:TRIGger:PATtern:FORMat command. The default <base> is BINary.

The :SBUS<n>:LIN:TRIGger:PATtern:DATA command specifies the LIN trigger data pattern searched for in each LIN data field.

Set a <string> bit to "0" or "1" to set the corresponding bit in the data pattern to low or high, respectively.

Set a <string> bit to "X" to ignore (mask off) that bit in the data pattern.

Use the "\$" character to indicate that the value of the corresponding bit will not be changed (the existing bit value is used).

When <base> = DECimal, the "X" and "\$" characters cannot be entered. When queried, the "\$" character is returned when any bits in the pattern have the value of "X" and <base> = DECimal. When any bits in a given nibble have the value of "X" and <base> = HEX, the "\$" character is returned for the corresponding nibble.

NOTE

The length of the trigger data value is determined by the :SBUS<n>:LIN:TRIGger:PATtern:DATA:LENGth command.

NOTE

If more bits are sent for <string> than the specified trigger pattern data length, the most significant bits will be truncated. If the data length size is changed after the <string> is programmed, the added or deleted bits will be added to or deleted from the least significant bits.

Query Syntax :SBUS<n>:LIN:TRIGger:PATtern:DATA?

The :SBUS<n>:LIN:TRIGger:PATtern:DATA? query returns the currently specified LIN trigger data pattern.

Return Format <string><NL>

- See Also
- [":SBUS<n>:LIN:TRIGger:FORMat"](#) on page 886
 - [":SBUS<n>:LIN:TRIGger"](#) on page 881
 - [":SBUS<n>:LIN:TRIGger:PATtern:DATA:LENGth"](#) on page 885

:SBUS<n>:LIN:TRIGger:PATtern:DATA:LENGth

N (see [page 1384](#))

Command Syntax :SBUS<n>:LIN:TRIGger:PATtern:DATA:LENGth <length>
 <length> ::= integer from 1 to 8 in NR1 format

The :SBUS<n>:LIN:TRIGger:PATtern:DATA:LENGth command sets the number of 8-bit bytes in the LIN data string. The number of bytes in the string can be anywhere from 1 bytes to 8 bytes (64 bits). The value for these bytes is set by the :SBUS<n>:LIN:TRIGger:PATtern:DATA command.

Query Syntax :SBUS<n>:LIN:TRIGger:PATtern:DATA:LENGth?

The :SBUS<n>:LIN:TRIGger:PATtern:DATA:LENGth? query returns the current LIN data pattern length setting.

Return Format <count><NL>
 <count> ::= integer from 1 to 8 in NR1 format

Errors • ["-241, Hardware missing"](#) on page 1343

See Also • ["Introduction to :TRIGger Commands"](#) on page 1097
 • [":SBUS<n>:LIN:TRIGger:PATtern:DATA"](#) on page 883
 • [":SBUS<n>:LIN:SOURce"](#) on page 878

:SBUS<n>:LIN:TRIGger:PATtern:FORMat

N (see [page 1384](#))

Command Syntax :SBUS<n>:LIN:TRIGger:PATtern:FORMat <base>

<base> ::= {BINary | HEX | DECimal}

The :SBUS<n>:LIN:TRIGger:PATtern:FORMat command sets the entry (and query) number base used by the :SBUS<n>:LIN:TRIGger:PATtern:DATA command. The default <base> is BINary.

Query Syntax :SBUS<n>:LIN:TRIGger:PATtern:FORMat?

The :SBUS<n>:LIN:TRIGger:PATtern:FORMat? query returns the currently set number base for LIN pattern data.

Return Format <base><NL>

<base> ::= {BIN | HEX | DEC}

- See Also**
- ["Introduction to :TRIGger Commands"](#) on page 1097
 - [":SBUS<n>:LIN:TRIGger:PATtern:DATA"](#) on page 883
 - [":SBUS<n>:LIN:TRIGger:PATtern:DATA:LENGth"](#) on page 885

:SBUS<n>:LIN:TRIGger:SYMBolic:FRAMe

N (see [page 1384](#))

Command Syntax :SBUS<n>:LIN:TRIGger:SYMBolic:FRAMe <name>

<name> ::= quoted ASCII string

The :SBUS<n>:LIN:TRIGger:SYMBolic:FRAMe command specifies the message to trigger on when LIN symbolic data has been loaded (recalled) into the oscilloscope and the LIN trigger mode is set to FRAMe or FSIGnal.

Query Syntax :SBUS<n>:LIN:TRIGger:SYMBolic:FRAMe?

The :SBUS<n>:LIN:TRIGger:SYMBolic:FRAMe? query returns the specified message.

Return Format <name><NL>

<name> ::= quoted ASCII string

- See Also**
- [":RECall:LDF\[:START\]"](#) on page 720
 - [":SBUS<n>:LIN:TRIGger"](#) on page 881
 - [":SBUS<n>:LIN:TRIGger:SYMBolic:SIGNaL"](#) on page 888
 - [":SBUS<n>:LIN:TRIGger:SYMBolic:VALue"](#) on page 889

:SBUS<n>:LIN:TRIGger:SYMBolic:SIGNal

N (see [page 1384](#))

Command Syntax :SBUS<n>:LIN:TRIGger:SYMBolic:SIGNal <name>

<name> ::= quoted ASCII string

The :SBUS<n>:LIN:TRIGger:SYMBolic:SIGNal command specifies the signal to trigger on when LIN symbolic data has been loaded (recalled) into the oscilloscope and the LIN trigger mode is set to FSIGNal.

Query Syntax :SBUS<n>:LIN:TRIGger:SYMBolic:SIGNal?

The :SBUS<n>:LIN:TRIGger:SYMBolic:SIGNal? query returns the specified signal.

Return Format <name><NL>

<name> ::= quoted ASCII string

- See Also**
- [":RECall:LDF\[:START\]"](#) on page 720
 - [":SBUS<n>:LIN:TRIGger"](#) on page 881
 - [":SBUS<n>:LIN:TRIGger:SYMBolic:FRAMe"](#) on page 887
 - [":SBUS<n>:LIN:TRIGger:SYMBolic:VALue"](#) on page 889

:SBUS<n>:LIN:TRIGger:SYMBolic:VALue

N (see [page 1384](#))

Command Syntax :SBUS<n>:LIN:TRIGger:SYMBolic:VALue <data>

<data> ::= value in NR3 format

The :SBUS<n>:LIN:TRIGger:SYMBolic:VALue command specifies the signal value to trigger on when LIN symbolic data has been loaded (recalled) into the oscilloscope and the LIN trigger mode is set to FSIGnal.

NOTE

Encoded signal values are not supported in the remote interface (even though they can be used in the front panel graphical interface).

Query Syntax :SBUS<n>:LIN:TRIGger:SYMBolic:VALue?

The :SBUS<n>:LIN:TRIGger:SYMBolic:VALue? query returns the specified signal value.

Return Format <data><NL>

<data> ::= value in NR3 format

- See Also**
- [":RECall:LDF\[:START\]"](#) on page 720
 - [":SBUS<n>:LIN:TRIGger"](#) on page 881
 - [":SBUS<n>:LIN:TRIGger:SYMBolic:FRAME"](#) on page 887
 - [":SBUS<n>:LIN:TRIGger:SYMBolic:SIGNal"](#) on page 888

:SBUS<n>:M1553 Commands

NOTE

These commands are valid when the DSOX4AERO MIL-STD-1553 and ARINC 429 triggering and serial decode option (Option AERO) has been licensed.

Table 119: :SBUS<n>:M1553 Commands Summary

Command	Query	Options and Query Returns
:SBUS<n>:M1553:AUTOsetup (see page 891)	n/a	n/a
:SBUS<n>:M1553:BASE<base> (see page 892)	:SBUS<n>:M1553:BASE? (see page 892)	<base> ::= {BINary HEX}
:SBUS<n>:M1553:SOURce<source> (see page 893)	:SBUS<n>:M1553:SOURce? (see page 893)	<source> ::= {CHANnel<n>} <n> ::= 1 to (# analog channels) in NR1 format
:SBUS<n>:M1553:TRIGger:PATtern:DATA<string> (see page 894)	:SBUS<n>:M1553:TRIGger:PATtern:DATA? (see page 894)	<string> ::= "nn...n" where n ::= {0 1 X}
:SBUS<n>:M1553:TRIGger:RTA<value> (see page 895)	:SBUS<n>:M1553:TRIGger:RTA? (see page 895)	<value> ::= 5-bit integer in decimal, <nondecimal>, or <string> from 0-31 <nondecimal> ::= #Hnn where n ::= {0,...,9 A,...,F} <string> ::= "0xnn" where n ::= {0,...,9 A,...,F}
:SBUS<n>:M1553:TRIGger:TYPE<type> (see page 896)	:SBUS<n>:M1553:TRIGger:TYPE? (see page 896)	<type> ::= {DSTArt DSTOp CSTArt CSTOp RTA PERRor SERRor MERRor RTA11}

:SBUS<n>:M1553:AUTOsetup

N (see [page 1384](#))

Command Syntax :SBUS<n>:M1553:TRIGger:AUTOsetup

The :SBUS<n>:M1553:AUTOsetup command automatically sets these options for decoding and triggering on MIL-STD-1553 signals:

- High/Low Trigger Thresholds: to a voltage value equal to $\pm 1/3$ division based on the source channel's current V/div setting.
- Noise Reject: Off.
- Probe Attenuation: 10.0.
- Serial Decode: On.
- Trigger: the specified serial bus (n of SBUS<n>).

- See Also**
- ["Introduction to :TRIGger Commands"](#) on page 1097
 - [":TRIGger:MODE"](#) on page 1106
 - [":SBUS<n>:M1553:SOURce"](#) on page 893

:SBUS<n>:M1553:BASE

N (see [page 1384](#))

Command Syntax :SBUS<n>:M1553:BASE <base>

<base> ::= {BINary | HEX}

The :SBUS<n>:M1553:BASE command determines the base to use for the MIL-STD-1553 decode display.

Query Syntax :SBUS<n>:M1553:BASE?

The :SBUS<n>:M1553:BASE? query returns the current MIL-STD-1553 display decode base.

Return Format <base><NL>

<base> ::= {BIN | HEX}

Errors • ["-241, Hardware missing"](#) on page 1343

See Also • ["Introduction to :SBUS<n> Commands"](#) on page 755

• [":SBUS<n>:M1553 Commands"](#) on page 890

:SBUS<n>:M1553:SOURce

N (see [page 1384](#))

Command Syntax :SBUS<n>:M1553:SOURce <source>

<source> ::= {CHANnel<n>}

<n> ::= 1 to (# analog channels) in NR1 format

The :SBUS<n>:M1553:SOURce command sets the source of the MIL-STD 1553 signal.

Use the :TRIGger:LEVel:HIGH and :TRIGger:LEVel:LOW commands to set the threshold levels for the selected source.

Query Syntax :SBUS<n>:M1553:TRIGger:SOURce?

The :SBUS<n>:M1553:SOURce? query returns the currently set source of the MIL-STD 1553 signal.

Return Format <source><NL>

<source> ::= {CHAN<n>}

<n> ::= 1 to (# analog channels) in NR1 format

- See Also**
- [":TRIGger:LEVel:HIGH"](#) on page 1104
 - [":TRIGger:LEVel:LOW"](#) on page 1105
 - [":TRIGger:MODE"](#) on page 1106
 - ["Introduction to :TRIGger Commands"](#) on page 1097

:SBUS<n>:M1553:TRIGger:PATtern:DATA

N (see [page 1384](#))

Command Syntax :SBUS<n>:M1553:TRIGger:PATtern:DATA <string>
 <string> ::= "nn...n" where n ::= {0 | 1 | X}

The :SBUS<n>:M1553:TRIGger:PATtern:DATA command sets the 11 bits to trigger on if the trigger type has been set to RTA11 (RTA + 11 Bits) using the :SBUS<n>:M1553:TRIGger:TYPE command.

Query Syntax :SBUS<n>:M1553:TRIGger:PATtern:DATA?

The :SBUS<n>:M1553:TRIGger:PATtern:DATA? query returns the current 11-bit setting.

Return Format <string><NL>
 <string> ::= "nn...n" where n ::= {0 | 1 | X}

- See Also**
- ["Introduction to :TRIGger Commands"](#) on page 1097
 - [":SBUS<n>:M1553:TRIGger:TYPE"](#) on page 896
 - [":SBUS<n>:M1553:TRIGger:RTA"](#) on page 895

:SBUS<n>:M1553:TRIGger:RTA

N (see [page 1384](#))

Command Syntax :SBUS<n>:M1553:TRIGger:RTA <value>

<value> ::= 5-bit integer in decimal, <nondecimal>, or
<string> from 0-31

<nondecimal> ::= #Hnn where n ::= {0,...,9|A,...,F}

<string> ::= "0xnn" where n ::= {0,...,9|A,...,F}

The :SBUS<n>:M1553:TRIGger:RTA command sets the Remote Terminal Address (RTA) to trigger on when the trigger type has been set to RTA or RTA11 (using the :SBUS<n>:M1553:TRIGger:TYPE command).

To set the RTA value to don't cares (0xXX), set the value to -1.

Query Syntax :SBUS<n>:M1553:TRIGger:RTA?

The :SBUS<n>:M1553:TRIGger:RTA? query returns the RTA value.

Return Format <value><NL> in decimal format

- See Also**
- ["Introduction to :TRIGger Commands"](#) on page 1097
 - [":SBUS<n>:M1553:TRIGger:TYPE"](#) on page 896

:SBUS<n>:M1553:TRIGger:TYPE

N (see [page 1384](#))

Command Syntax :SBUS<n>:M1553:TRIGger:TYPE <type>

<type> ::= {DStArt | DStOp | CStArt | CStOp | RTA | PERRor | SERRor
| MERRor | RTA11}

The :SBUS<n>:M1553:TRIGger:TYPE command specifies the type of MIL-STD-1553 trigger to be used:

- DStArt – (Data Word Start) triggers on the start of a Data word (at the end of a valid Data Sync pulse).
- DStOp – (Data Word Stop) triggers on the end of a Data word.
- CStArt – (Command/Status Word Start) triggers on the start of Command/Status word (at the end of a valid C/S Sync pulse).
- CStOp – (Command/Status Word Stop) triggers on the end of a Command/Status word.
- RTA – (Remote Terminal Address) triggers if the RTA of the Command/Status word matches the specified value. The value is specified in hex.
- RTA11 – (RTA + 11 Bits) triggers if the RTA and the remaining 11 bits match the specified criteria. The RTA can be specified as a hex value, and the remaining 11 bits can be specified as a 1, 0, or X (don't care).
- PERRor – (Parity Error) triggers if the (odd) parity bit is incorrect for the data in the word.
- MERRor – (Manchester Error) triggers if a Manchester encoding error is detected.
- SERRor – (Sync Error) triggers if an invalid Sync pulse is found.

Query Syntax :SBUS<n>:M1553:TRIGger:TYPE?

The :SBUS<n>:M1553:TRIGger:TYPE? query returns the currently set MIL-STD-1553 trigger type.

Return Format <type><NL>

<type> ::= {DStA | DStO | CStA | CStO | RTA | PERR | SERR
| MERR | RTA11}

- See Also**
- ["Introduction to :TRIGger Commands"](#) on page 1097
 - [":SBUS<n>:M1553:TRIGger:RTA"](#) on page 895
 - [":SBUS<n>:M1553:TRIGger:PATtern:DATA"](#) on page 894
 - [":TRIGger:MODE"](#) on page 1106

:SBUS<n>:SENT Commands

NOTE

These commands are valid when the automotive SENT serial decode and triggering option has been licensed.

Table 120:SBUS<n>:SENT Commands Summary

Command	Query	Options and Query Returns
:SBUS<n>:SENT:CLOCK <period> (see page 900)	:SBUS<n>:SENT:CLOCK? (see page 900)	<period> ::= the nominal clock period (tick), from 1 us to 300 us, in NR3 format.
:SBUS<n>:SENT:CRC <format> (see page 901)	:SBUS<n>:SENT:CRC? (see page 901)	<format> ::= {LEGacy RECommended}
:SBUS<n>:SENT:DISPlay <base> (see page 902)	:SBUS<n>:SENT:DISPlay ? (see page 902)	<base> ::= {HEX DECimal SYMBolic}
:SBUS<n>:SENT:FORMat <decode> (see page 904)	:SBUS<n>:SENT:FORMat? (see page 904)	<decode> ::= {NIBBles FSIGnal FSSerial FESerial SSERial ESERial}
:SBUS<n>:SENT:IDLE <state> (see page 906)	:SBUS<n>:SENT:IDLE? (see page 906)	<state> ::= {LOW HIGH}
:SBUS<n>:SENT:LENGth <#_nibbles> (see page 907)	:SBUS<n>:SENT:LENGth? (see page 907)	<#_nibbles> ::= from 1-6, in NR1 format.
:SBUS<n>:SENT:PPULse {{0 OFF} {1 ON}} (see page 908)	:SBUS<n>:SENT:PPULse? (see page 908)	{0 1}
:SBUS<n>:SENT:SIGnal<s>:DISPlay {{0 OFF} {1 ON}} (see page 909)	:SBUS<n>:SENT:SIGnal<s>:DISPlay? (see page 909)	<s> ::= 1-6, in NR1 format. {0 1}
:SBUS<n>:SENT:SIGnal<s>:LENGth <length> (see page 910)	:SBUS<n>:SENT:SIGnal<s>:LENGth? (see page 910)	<s> ::= 1-6, in NR1 format. <length> ::= from 1-24, in NR1 format.
:SBUS<n>:SENT:SIGnal<s>:MULTiplier <multiplier> (see page 912)	:SBUS<n>:SENT:SIGnal<s>:MULTiplier? (see page 912)	<s> ::= 1-6, in NR1 format. <multiplier> ::= from 1-24, in NR3 format.
:SBUS<n>:SENT:SIGnal<s>:OFFSet <offset> (see page 913)	:SBUS<n>:SENT:SIGnal<s>:OFFSet? (see page 913)	<s> ::= 1-6, in NR1 format. <offset> ::= from 1-24, in NR3 format.

Table 120: :SBUS<n>:SENT Commands Summary (continued)

Command	Query	Options and Query Returns
:SBUS<n>:SENT:SIGnAl<s>:ORDER <order> (see page 914)	:SBUS<n>:SENT:SIGnAl<s>:ORDER? (see page 914)	<s> ::= 1-6, in NR1 format. <order> ::= {MSNFirst LSNFirst}
:SBUS<n>:SENT:SIGnAl<s>:START <position> (see page 916)	:SBUS<n>:SENT:SIGnAl<s>:START? (see page 916)	<s> ::= 1-6, in NR1 format. <position> ::= from 0-23, in NR1 format.
:SBUS<n>:SENT:SOURce <source> (see page 918)	:SBUS<n>:SENT:SOURce? (see page 918)	<source> ::= {CHANnel<n> DIGital<d>} <n> ::= 1 to (# analog channels) in NR1 format <d> ::= 0 to (# digital channels - 1) in NR1 format
:SBUS<n>:SENT:TOLeranCe <percent> (see page 920)	:SBUS<n>:SENT:TOLeranCe? (see page 920)	<percent> ::= from 3-30, in NR1 format.
:SBUS<n>:SENT:TRIGger <mode> (see page 921)	:SBUS<n>:SENT:TRIGger? (see page 921)	<mode> ::= {SFCMessage SSCMessage FCData SCMid SCData FCCError SCCError CRCError TOLerror PPERror SSPerror}
:SBUS<n>:SENT:TRIGger:FAST:DATA <string> (see page 923)	:SBUS<n>:SENT:TRIGger:FAST:DATA? (see page 923)	<string> ::= "nnnn..." where n ::= {0 1 X} <string> ::= "0xn..." where n ::= {0,...,9 A,...,F X \$}
:SBUS<n>:SENT:TRIGger:SLOW:DATA <data> (see page 924)	:SBUS<n>:SENT:TRIGger:SLOW:DATA? (see page 924)	<data> ::= when ILENgth = SHORt, from -1 (don't care) to 65535, in NR1 format. <data> ::= when ILENgth = LONG, from -1 (don't care) to 4095, in NR1 format.
:SBUS<n>:SENT:TRIGger:SLOW:ID <id> (see page 926)	:SBUS<n>:SENT:TRIGger:SLOW:ID? (see page 926)	<id> ::= when ILENgth = SHORt, from -1 (don't care) to 15, in NR1 format. <id> ::= when ILENgth = LONG, from -1 (don't care) to 255, in NR1 format.

Table 120: :SBUS<n>:SENT Commands Summary (continued)

Command	Query	Options and Query Returns
:SBUS<n>:SENT:TRIGger :SLOW:ILENgtH <length> (see page 928)	:SBUS<n>:SENT:TRIGger :SLOW:ILENgtH? (see page 928)	<length> ::= {SHORT LONG}
:SBUS<n>:SENT:TRIGger :TOLerance <percent> (see page 929)	:SBUS<n>:SENT:TRIGger :TOLerance? (see page 929)	<percent> ::= from 1-18, in NR1 format.

:SBUS<n>:SENT:CLOCK

N (see [page 1384](#))

Command Syntax :SBUS<n>:SENT:CLOCK <period>

<period> ::= the nominal clock period (tick), from 1 us to 300 us, in NR3 format.

The :SBUS<n>:SENT:CLOCK command specifies the nominal clock period (tick), from 1 μs to 300 μs.

Query Syntax :SBUS<n>:SENT:CLOCK?

The :SBUS<n>:SENT:CLOCK? query returns the clock period setting.

Return Format <period><NL>

<period> ::= the nominal clock period (tick), from 1 us to 300 us, in NR3 format.

- See Also**
- [":SBUS<n>:SENT:CRC"](#) on page 901
 - [":SBUS<n>:SENT:DISPlay"](#) on page 902
 - [":SBUS<n>:SENT:FORMat"](#) on page 904
 - [":SBUS<n>:SENT:IDLE"](#) on page 906
 - [":SBUS<n>:SENT:LENGth"](#) on page 907
 - [":SBUS<n>:SENT:PPULse"](#) on page 908
 - [":SBUS<n>:SENT:SIGNal<s>:DISPlay"](#) on page 909
 - [":SBUS<n>:SENT:SIGNal<s>:LENGth"](#) on page 910
 - [":SBUS<n>:SENT:SIGNal<s>:MULTIplier"](#) on page 912
 - [":SBUS<n>:SENT:SIGNal<s>:OFFSet"](#) on page 913
 - [":SBUS<n>:SENT:SIGNal<s>:ORDer"](#) on page 914
 - [":SBUS<n>:SENT:SIGNal<s>:START"](#) on page 916
 - [":SBUS<n>:SENT:SOURce"](#) on page 918
 - [":SBUS<n>:SENT:TOLerance"](#) on page 920
 - [":SBUS<n>:SENT:TRIGger"](#) on page 921
 - [":SBUS<n>:SENT:TRIGger:FAST:DATA"](#) on page 923
 - [":SBUS<n>:SENT:TRIGger:SLOW:DATA"](#) on page 924
 - [":SBUS<n>:SENT:TRIGger:SLOW:ID"](#) on page 926
 - [":SBUS<n>:SENT:TRIGger:SLOW:ILENght"](#) on page 928
 - [":SBUS<n>:SENT:TRIGger:TOLerance"](#) on page 929

:SBUS<n>:SENT:CRC

N (see [page 1384](#))

Command Syntax :SBUS<n>:SENT:CRC <format>

<format> ::= {LEGacy | RECommended}

The :SBUS<n>:SENT:CRC command specifies the format of the CRC. Either Legacy (2008) or Recommended (2010).

Enhanced Serial Message CRCs are always calculated using the 2010 format, but for the Fast Channel Messages, and for Short Serial Message CRCs, this setting is used.

Query Syntax :SBUS<n>:SENT:CRC?

The :SBUS<n>:SENT:CRC? query returns the CRC format setting.

Return Format <format><NL>

<format> ::= {LEG | REC}

- See Also**
- [":SBUS<n>:SENT:CLOCK"](#) on page 900
 - [":SBUS<n>:SENT:DISPlay"](#) on page 902
 - [":SBUS<n>:SENT:FORMat"](#) on page 904
 - [":SBUS<n>:SENT:IDLE"](#) on page 906
 - [":SBUS<n>:SENT:LENGth"](#) on page 907
 - [":SBUS<n>:SENT:PPULse"](#) on page 908
 - [":SBUS<n>:SENT:SIGNal<s>:DISPlay"](#) on page 909
 - [":SBUS<n>:SENT:SIGNal<s>:LENGth"](#) on page 910
 - [":SBUS<n>:SENT:SIGNal<s>:MULTIplier"](#) on page 912
 - [":SBUS<n>:SENT:SIGNal<s>:OFFSet"](#) on page 913
 - [":SBUS<n>:SENT:SIGNal<s>:ORDer"](#) on page 914
 - [":SBUS<n>:SENT:SIGNal<s>:START"](#) on page 916
 - [":SBUS<n>:SENT:SOURce"](#) on page 918
 - [":SBUS<n>:SENT:TOLerance"](#) on page 920
 - [":SBUS<n>:SENT:TRIGger"](#) on page 921
 - [":SBUS<n>:SENT:TRIGger:FAST:DATA"](#) on page 923
 - [":SBUS<n>:SENT:TRIGger:SLOW:DATA"](#) on page 924
 - [":SBUS<n>:SENT:TRIGger:SLOW:ID"](#) on page 926
 - [":SBUS<n>:SENT:TRIGger:SLOW:ILENght"](#) on page 928
 - [":SBUS<n>:SENT:TRIGger:TOLerance"](#) on page 929

:SBUS<n>:SENT:DISPlay

N (see [page 1384](#))

Command Syntax :SBUS<n>:SENT:DISPlay <base>

<base> ::= {HEX | DECimal | SYMBolic}

The :SBUS<n>:SENT:DISPlay command specifies the number base used by the decoder. The chosen base is used for the data nibbles in Raw decode format, the defined Signals in the other formats, and for the data field of the Serial Messages.

This selection is used for both the Lister and the decode line displays.

When SYMBolic is selected, Fast Channel Signals display a calculated physical value based on the specified multiplier and offset:

- $PhysicalValue = (Multiplier * SignalValueAsUnsignedInteger) + Offset$

When SYMBolic is selected, the CRC and Slow Channel information is displayed in hex.

Query Syntax :SBUS<n>:SENT:DISPlay?

The :SBUS<n>:SENT:DISPlay? query returns the SENT decode number base setting.

Return Format <base><NL>

<base> ::= {HEX | DEC | SYMB}

- See Also**
- [":SBUS<n>:SENT:CLOCK"](#) on page 900
 - [":SBUS<n>:SENT:CRC"](#) on page 901
 - [":SBUS<n>:SENT:FORMat"](#) on page 904
 - [":SBUS<n>:SENT:IDLE"](#) on page 906
 - [":SBUS<n>:SENT:LENGth"](#) on page 907
 - [":SBUS<n>:SENT:PPULse"](#) on page 908
 - [":SBUS<n>:SENT:SIGNal<s>:DISPlay"](#) on page 909
 - [":SBUS<n>:SENT:SIGNal<s>:LENGth"](#) on page 910
 - [":SBUS<n>:SENT:SIGNal<s>:MULTiplier"](#) on page 912
 - [":SBUS<n>:SENT:SIGNal<s>:OFFSet"](#) on page 913
 - [":SBUS<n>:SENT:SIGNal<s>:ORDer"](#) on page 914
 - [":SBUS<n>:SENT:SIGNal<s>:START"](#) on page 916
 - [":SBUS<n>:SENT:SOURce"](#) on page 918
 - [":SBUS<n>:SENT:TOLerance"](#) on page 920
 - [":SBUS<n>:SENT:TRIGger"](#) on page 921
 - [":SBUS<n>:SENT:TRIGger:FAST:DATA"](#) on page 923

- `":SBUS<n>:SENT:TRIGger:SLOW:DATA"` on page 924
- `":SBUS<n>:SENT:TRIGger:SLOW:ID"` on page 926
- `":SBUS<n>:SENT:TRIGger:SLOW:ILENgtH"` on page 928
- `":SBUS<n>:SENT:TRIGger:TOLerance"` on page 929

:SBUS<n>:SENT:FORMat

N (see [page 1384](#))

Command Syntax :SBUS<n>:SENT:FORMat <decode>

<decode> ::= {NIBBles | FSIGNal | FSSerial | FESerial | SSERial | ESERial}

The :SBUS<n>:SENT:FORMat command specifies the message decode/triggering format:

- NIBBles – displays the raw transmitted nibble values.
- FSIGNal – displays Fast Channel Message Signals.
- FSSerial – displays both Fast and Slow Messages (Short format) simultaneously.
- FESerial – displays both Fast and Slow Messages (Enhanced format) simultaneously.
- SSERial – displays Slow Channel Messages in Short format.
- ESERial – displays Slow Channel Messages in Enhanced format.

This selection affects both decoding and triggering. The decode is affected both in how the system interprets the data, and what will be displayed. The trigger is affected in that the trigger hardware needs to be configured to trigger on serial messages correctly.

You can specify the nibble display order for Fast Channel Message Signals (see :SBUS<n>:SENT:SIGNal<s>:ORDER). Raw transmitted nibble values are displayed in the order received.

Note that for the Slow Channel, the proper format, Short or Enhanced, must be chosen for proper decoding and triggering to occur.

Slow Channel Serial Messages are always displayed as defined by the SENT specification.

Query Syntax :SBUS<n>:SENT:FORMat?

The :SBUS<n>:SENT:FORMat? query returns the message decode/triggering format setting.

Return Format <decode><NL>

<decode> ::= {NIBB | FSIG | FSS | FES | SSER | ESER}

- See Also**
- **"[:SBUS<n>:SENT:CLOCK](#)"** on page 900
 - **"[:SBUS<n>:SENT:CRC](#)"** on page 901
 - **"[:SBUS<n>:SENT:DISPlay](#)"** on page 902
 - **"[:SBUS<n>:SENT:IDLE](#)"** on page 906
 - **"[:SBUS<n>:SENT:LENGth](#)"** on page 907

- **":SBUS<n>:SENT:PPULse"** on page 908
- **":SBUS<n>:SENT:SIGNal<s>:DISPlay"** on page 909
- **":SBUS<n>:SENT:SIGNal<s>:LENGth"** on page 910
- **":SBUS<n>:SENT:SIGNal<s>:MULTIplier"** on page 912
- **":SBUS<n>:SENT:SIGNal<s>:OFFSet"** on page 913
- **":SBUS<n>:SENT:SIGNal<s>:ORDer"** on page 914
- **":SBUS<n>:SENT:SIGNal<s>:START"** on page 916
- **":SBUS<n>:SENT:SOURce"** on page 918
- **":SBUS<n>:SENT:TOLerance"** on page 920
- **":SBUS<n>:SENT:TRIGger"** on page 921
- **":SBUS<n>:SENT:TRIGger:FAST:DATA"** on page 923
- **":SBUS<n>:SENT:TRIGger:SLOW:DATA"** on page 924
- **":SBUS<n>:SENT:TRIGger:SLOW:ID"** on page 926
- **":SBUS<n>:SENT:TRIGger:SLOW:ILENght"** on page 928
- **":SBUS<n>:SENT:TRIGger:TOLerance"** on page 929

:SBUS<n>:SENT:IDLE

N (see [page 1384](#))

Command Syntax :SBUS<n>:SENT:IDLE <state>
 <state> ::= {LOW | HIGH}

The :SBUS<n>:SENT:IDLE command specifies the idle state of the SENT bus.

Query Syntax :SBUS<n>:SENT:IDLE?

The :SBUS<n>:SENT:IDLE? query returns the idle state setting.

Return Format <state><NL>
 <state> ::= {LOW | HIGH}

- See Also**
- [":SBUS<n>:SENT:CLOCK"](#) on page 900
 - [":SBUS<n>:SENT:CRC"](#) on page 901
 - [":SBUS<n>:SENT:DISPlay"](#) on page 902
 - [":SBUS<n>:SENT:FORMat"](#) on page 904
 - [":SBUS<n>:SENT:LENGth"](#) on page 907
 - [":SBUS<n>:SENT:PPULse"](#) on page 908
 - [":SBUS<n>:SENT:SIGNal<s>:DISPlay"](#) on page 909
 - [":SBUS<n>:SENT:SIGNal<s>:LENGth"](#) on page 910
 - [":SBUS<n>:SENT:SIGNal<s>:MULTIplier"](#) on page 912
 - [":SBUS<n>:SENT:SIGNal<s>:OFFSet"](#) on page 913
 - [":SBUS<n>:SENT:SIGNal<s>:ORDER"](#) on page 914
 - [":SBUS<n>:SENT:SIGNal<s>:START"](#) on page 916
 - [":SBUS<n>:SENT:SOURce"](#) on page 918
 - [":SBUS<n>:SENT:TOLerance"](#) on page 920
 - [":SBUS<n>:SENT:TRIGger"](#) on page 921
 - [":SBUS<n>:SENT:TRIGger:FAST:DATA"](#) on page 923
 - [":SBUS<n>:SENT:TRIGger:SLOW:DATA"](#) on page 924
 - [":SBUS<n>:SENT:TRIGger:SLOW:ID"](#) on page 926
 - [":SBUS<n>:SENT:TRIGger:SLOW:ILENght"](#) on page 928
 - [":SBUS<n>:SENT:TRIGger:TOLerance"](#) on page 929

:SBUS<n>:SENT:LENGth

N (see [page 1384](#))

Command Syntax :SBUS<n>:SENT:LENGth <#_nibbles>

<#_nibbles> ::= from 1-6, in NR1 format.

The :SBUS<n>:SENT:LENGth command specifies the number of nibbles in a SENT message, from 1 to 6.

Query Syntax :SBUS<n>:SENT:LENGth?

The :SBUS<n>:SENT:LENGth? query returns the number of nibbles setting.

Return Format <#_nibbles><NL>

<#_nibbles> ::= from 1-6, in NR1 format.

- See Also**
- [":SBUS<n>:SENT:CLOCK"](#) on page 900
 - [":SBUS<n>:SENT:CRC"](#) on page 901
 - [":SBUS<n>:SENT:DISPlay"](#) on page 902
 - [":SBUS<n>:SENT:FORMat"](#) on page 904
 - [":SBUS<n>:SENT:IDLE"](#) on page 906
 - [":SBUS<n>:SENT:PPULse"](#) on page 908
 - [":SBUS<n>:SENT:SIGNal<s>:DISPlay"](#) on page 909
 - [":SBUS<n>:SENT:SIGNal<s>:LENGth"](#) on page 910
 - [":SBUS<n>:SENT:SIGNal<s>:MULTIplier"](#) on page 912
 - [":SBUS<n>:SENT:SIGNal<s>:OFFSet"](#) on page 913
 - [":SBUS<n>:SENT:SIGNal<s>:ORDer"](#) on page 914
 - [":SBUS<n>:SENT:SIGNal<s>:START"](#) on page 916
 - [":SBUS<n>:SENT:SOURce"](#) on page 918
 - [":SBUS<n>:SENT:TOLerance"](#) on page 920
 - [":SBUS<n>:SENT:TRIGger"](#) on page 921
 - [":SBUS<n>:SENT:TRIGger:FAST:DATA"](#) on page 923
 - [":SBUS<n>:SENT:TRIGger:SLOW:DATA"](#) on page 924
 - [":SBUS<n>:SENT:TRIGger:SLOW:ID"](#) on page 926
 - [":SBUS<n>:SENT:TRIGger:SLOW:ILENGth"](#) on page 928
 - [":SBUS<n>:SENT:TRIGger:TOLerance"](#) on page 929

:SBUS<n>:SENT:PPULse

N (see [page 1384](#))

Command Syntax :SBUS<n>:SENT:PPULse {{0 | OFF} | {1 | ON}}

The :SBUS<n>:SENT:PPULse command specifies whether the SENT messages are followed by a pause pulse.

Query Syntax :SBUS<n>:SENT:PPULse?

The :SBUS<n>:SENT:PPULse? query returns the pause pulse setting.

Return Format <setting><NL>

<setting> ::= {0 | 1}

- See Also**
- [":SBUS<n>:SENT:CLOCK"](#) on page 900
 - [":SBUS<n>:SENT:CRC"](#) on page 901
 - [":SBUS<n>:SENT:DISPlay"](#) on page 902
 - [":SBUS<n>:SENT:FORMat"](#) on page 904
 - [":SBUS<n>:SENT:IDLE"](#) on page 906
 - [":SBUS<n>:SENT:LENGth"](#) on page 907
 - [":SBUS<n>:SENT:SIGNal<s>:DISPlay"](#) on page 909
 - [":SBUS<n>:SENT:SIGNal<s>:LENGth"](#) on page 910
 - [":SBUS<n>:SENT:SIGNal<s>:MULTiplier"](#) on page 912
 - [":SBUS<n>:SENT:SIGNal<s>:OFFSet"](#) on page 913
 - [":SBUS<n>:SENT:SIGNal<s>:ORDer"](#) on page 914
 - [":SBUS<n>:SENT:SIGNal<s>:START"](#) on page 916
 - [":SBUS<n>:SENT:SOURce"](#) on page 918
 - [":SBUS<n>:SENT:TOLerance"](#) on page 920
 - [":SBUS<n>:SENT:TRIGger"](#) on page 921
 - [":SBUS<n>:SENT:TRIGger:FAST:DATA"](#) on page 923
 - [":SBUS<n>:SENT:TRIGger:SLOW:DATA"](#) on page 924
 - [":SBUS<n>:SENT:TRIGger:SLOW:ID"](#) on page 926
 - [":SBUS<n>:SENT:TRIGger:SLOW:ILENght"](#) on page 928
 - [":SBUS<n>:SENT:TRIGger:TOLerance"](#) on page 929

:SBUS<n>:SENT:SIGNAl<s>:DISPlay

N (see [page 1384](#))

Command Syntax :SBUS<n>:SENT:SIGNAl<s>:DISPlay {{0 | OFF} | {1 | ON}}

<s> ::= 1-6, in NR1 format.

The :SBUS<n>:SENT:SIGNAl<s>:DISPlay command specifies whether the given signal is on or off.

Query Syntax :SBUS<n>:SENT:SIGNAl<s>:DISPlay?

The :SBUS<n>:SENT:SIGNAl<s>:DISPlay? query returns the signal on/off setting.

Return Format <setting><NL>

<setting> ::= {0 | 1}

- See Also**
- [":SBUS<n>:SENT:CLOCK"](#) on page 900
 - [":SBUS<n>:SENT:CRC"](#) on page 901
 - [":SBUS<n>:SENT:DISPlay"](#) on page 902
 - [":SBUS<n>:SENT:FORMat"](#) on page 904
 - [":SBUS<n>:SENT:IDLE"](#) on page 906
 - [":SBUS<n>:SENT:LENGth"](#) on page 907
 - [":SBUS<n>:SENT:PPULse"](#) on page 908
 - [":SBUS<n>:SENT:SIGNAl<s>:LENGth"](#) on page 910
 - [":SBUS<n>:SENT:SIGNAl<s>:MULTIplier"](#) on page 912
 - [":SBUS<n>:SENT:SIGNAl<s>:OFFSet"](#) on page 913
 - [":SBUS<n>:SENT:SIGNAl<s>:ORDer"](#) on page 914
 - [":SBUS<n>:SENT:SIGNAl<s>:START"](#) on page 916
 - [":SBUS<n>:SENT:SOURce"](#) on page 918
 - [":SBUS<n>:SENT:TOLerance"](#) on page 920
 - [":SBUS<n>:SENT:TRIGger"](#) on page 921
 - [":SBUS<n>:SENT:TRIGger:FAST:DATA"](#) on page 923
 - [":SBUS<n>:SENT:TRIGger:SLOW:DATA"](#) on page 924
 - [":SBUS<n>:SENT:TRIGger:SLOW:ID"](#) on page 926
 - [":SBUS<n>:SENT:TRIGger:SLOW:ILENgth"](#) on page 928
 - [":SBUS<n>:SENT:TRIGger:TOLerance"](#) on page 929

:SBUS<n>:SENT:SIGNAl<s>:LENGth

N (see [page 1384](#))

Command Syntax :SBUS<n>:SENT:SIGNAl<s>:LENGth <length>

<s> ::= 1-6, in NR1 format.

<length> ::= from 1-24, in NR1 format.

The :SBUS<n>:SENT:SIGNAl<s>:LENGth command specifies the bit length of the signal being defined.

Fast Signal definition examples:

Example 1: Start Bit # = 13, # of bits = 8, Nibble Order = LSN First

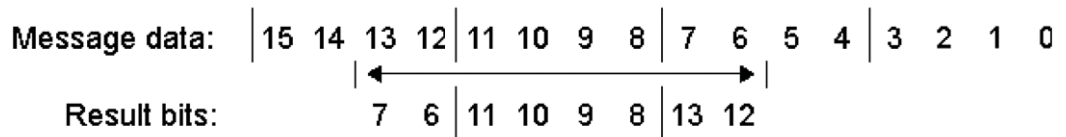

Example 2: Start Bit # = 10, # of bits = 5, Nibble Order = MSN First

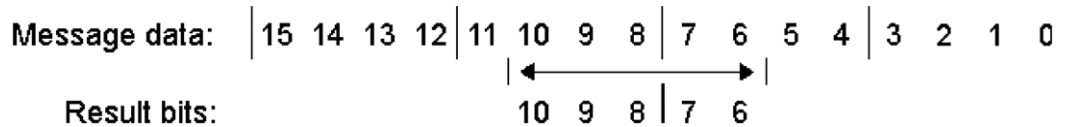

Query Syntax :SBUS<n>:SENT:SIGNAl<s>:LENGth?

The :SBUS<n>:SENT:SIGNAl<s>:LENGth? query returns the signal bit length setting.

Return Format <length><NL>

<length> ::= from 1-24, in NR1 format.

- See Also**
- **":SBUS<n>:SENT:CLOCK"** on page 900
 - **":SBUS<n>:SENT:CRC"** on page 901
 - **":SBUS<n>:SENT:DISPlay"** on page 902
 - **":SBUS<n>:SENT:FORMat"** on page 904
 - **":SBUS<n>:SENT:IDLE"** on page 906
 - **":SBUS<n>:SENT:LENGth"** on page 907
 - **":SBUS<n>:SENT:PPULse"** on page 908
 - **":SBUS<n>:SENT:SIGNAl<s>:DISPlay"** on page 909
 - **":SBUS<n>:SENT:SIGNAl<s>:MULTiplier"** on page 912

- **":SBUS<n>:SENT:SIGNAl<s>:OFFSet"** on page 913
- **":SBUS<n>:SENT:SIGNAl<s>:ORDer"** on page 914
- **":SBUS<n>:SENT:SIGNAl<s>:START"** on page 916
- **":SBUS<n>:SENT:SOURce"** on page 918
- **":SBUS<n>:SENT:TOLerance"** on page 920
- **":SBUS<n>:SENT:TRIGger"** on page 921
- **":SBUS<n>:SENT:TRIGger:FAST:DATA"** on page 923
- **":SBUS<n>:SENT:TRIGger:SLOW:DATA"** on page 924
- **":SBUS<n>:SENT:TRIGger:SLOW:ID"** on page 926
- **":SBUS<n>:SENT:TRIGger:SLOW:ILENgtH"** on page 928
- **":SBUS<n>:SENT:TRIGger:TOLerance"** on page 929

:SBUS<n>:SENT:SIGNal<s>:MULTIplier

N (see [page 1384](#))

Command Syntax :SBUS<n>:SENT:SIGNal<s>:MULTIplier <multiplier>

<s> ::= 1-6, in NR1 format.

<multiplier> ::= from 1-24, in NR3 format.

When the display mode setting is SYMBolic (see :SBUS<n>:SENT:DISPlay), the :SBUS<n>:SENT:SIGNal<s>:MULTIplier command specifies the multiplier to be used in calculating a physical value displayed for a Fast Channel Signal.

- $PhysicalValue = (Multiplier * SignalValueAsUnsignedInteger) + Offset$

Query Syntax :SBUS<n>:SENT:SIGNal<s>:MULTIplier?

The :SBUS<n>:SENT:SIGNal<s>:MULTIplier? query returns the multiplier value for the Fast Channel Signal.

Return Format <multiplier><NL>

<multiplier> ::= from 1-24, in NR3 format.

- See Also**
- [":SBUS<n>:SENT:CLOCK"](#) on page 900
 - [":SBUS<n>:SENT:CRC"](#) on page 901
 - [":SBUS<n>:SENT:DISPlay"](#) on page 902
 - [":SBUS<n>:SENT:FORMat"](#) on page 904
 - [":SBUS<n>:SENT:IDLE"](#) on page 906
 - [":SBUS<n>:SENT:LENGth"](#) on page 907
 - [":SBUS<n>:SENT:PPULse"](#) on page 908
 - [":SBUS<n>:SENT:SIGNal<s>:DISPlay"](#) on page 909
 - [":SBUS<n>:SENT:SIGNal<s>:LENGth"](#) on page 910
 - [":SBUS<n>:SENT:SIGNal<s>:OFFSet"](#) on page 913
 - [":SBUS<n>:SENT:SIGNal<s>:ORDer"](#) on page 914
 - [":SBUS<n>:SENT:SIGNal<s>:START"](#) on page 916
 - [":SBUS<n>:SENT:SOURce"](#) on page 918
 - [":SBUS<n>:SENT:TOLerance"](#) on page 920
 - [":SBUS<n>:SENT:TRIGger"](#) on page 921
 - [":SBUS<n>:SENT:TRIGger:FAST:DATA"](#) on page 923
 - [":SBUS<n>:SENT:TRIGger:SLOW:DATA"](#) on page 924
 - [":SBUS<n>:SENT:TRIGger:SLOW:ID"](#) on page 926
 - [":SBUS<n>:SENT:TRIGger:SLOW:ILENgth"](#) on page 928
 - [":SBUS<n>:SENT:TRIGger:TOLerance"](#) on page 929

:SBUS<n>:SENT:SIGNAl<s>:OFFSet

N (see [page 1384](#))

Command Syntax :SBUS<n>:SENT:SIGNAl<s>:OFFSet <offset>

<s> ::= 1-6, in NR1 format.

<offset> ::= from 1-24, in NR3 format.

When the display mode setting is SYMBolic (see :SBUS<n>:SENT:DISPlay), the :SBUS<n>:SENT:SIGNAl<s>:OFFSet command is used in calculating a physical value displayed for the Fast Channel Signal:

- $PhysicalValue = (Multiplier * SignalValueAsUnsignedInteger) + Offset$

Query Syntax :SBUS<n>:SENT:SIGNAl<s>:OFFSet?

The :SBUS<n>:SENT:SIGNAl<s>:OFFSet? query returns the offset value for the Fast Channel Signal.

Return Format <offset><NL>

<offset> ::= from 1-24, in NR3 format.

- See Also**
- [":SBUS<n>:SENT:CLOCK"](#) on page 900
 - [":SBUS<n>:SENT:CRC"](#) on page 901
 - [":SBUS<n>:SENT:DISPlay"](#) on page 902
 - [":SBUS<n>:SENT:FORMat"](#) on page 904
 - [":SBUS<n>:SENT:IDLE"](#) on page 906
 - [":SBUS<n>:SENT:LENGth"](#) on page 907
 - [":SBUS<n>:SENT:PPULse"](#) on page 908
 - [":SBUS<n>:SENT:SIGNAl<s>:DISPlay"](#) on page 909
 - [":SBUS<n>:SENT:SIGNAl<s>:LENGth"](#) on page 910
 - [":SBUS<n>:SENT:SIGNAl<s>:MULTIplier"](#) on page 912
 - [":SBUS<n>:SENT:SIGNAl<s>:ORDer"](#) on page 914
 - [":SBUS<n>:SENT:SIGNAl<s>:START"](#) on page 916
 - [":SBUS<n>:SENT:SOURce"](#) on page 918
 - [":SBUS<n>:SENT:TOLerance"](#) on page 920
 - [":SBUS<n>:SENT:TRIGger"](#) on page 921
 - [":SBUS<n>:SENT:TRIGger:FAST:DATA"](#) on page 923
 - [":SBUS<n>:SENT:TRIGger:SLOW:DATA"](#) on page 924
 - [":SBUS<n>:SENT:TRIGger:SLOW:ID"](#) on page 926
 - [":SBUS<n>:SENT:TRIGger:SLOW:ILENgth"](#) on page 928
 - [":SBUS<n>:SENT:TRIGger:TOLerance"](#) on page 929

:SBUS<n>:SENT:SIGNAl<s>:ORDER

N (see [page 1384](#))

Command Syntax :SBUS<n>:SENT:SIGNAl<s>:ORDER <order>

<s> ::= 1-6, in NR1 format.

<order> ::= {MSNFirst | LSNFirst}

The :SBUS<n>:SENT:SIGNAl<s>:ORDER command specifies the nibble order of the signal being defined, either Most Significant Nibble first, or Least Significant Nibble first.

Fast Signal definition examples:

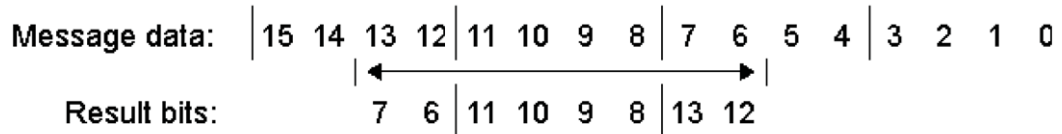
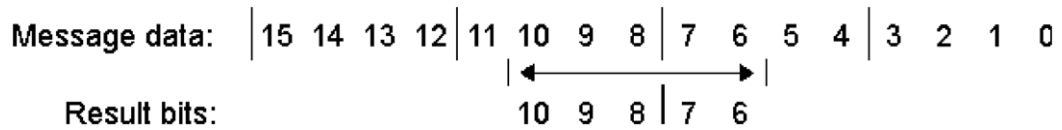
Example 1: Start Bit # = 13, # of bits = 8, Nibble Order = LSN First**Example 2: Start Bit # = 10, # of bits = 5, Nibble Order = MSN First**

Query Syntax :SBUS<n>:SENT:SIGNAl<s>:ORDER?

The :SBUS<n>:SENT:SIGNAl<s>:ORDER? query returns the nibble order setting.

Return Format <order><NL>

<order> ::= {MSNF | LSNF}

- See Also**
- [":SBUS<n>:SENT:CLOCK"](#) on page 900
 - [":SBUS<n>:SENT:CRC"](#) on page 901
 - [":SBUS<n>:SENT:DISPlay"](#) on page 902
 - [":SBUS<n>:SENT:FORMat"](#) on page 904
 - [":SBUS<n>:SENT:IDLE"](#) on page 906
 - [":SBUS<n>:SENT:LENGth"](#) on page 907
 - [":SBUS<n>:SENT:PPULse"](#) on page 908
 - [":SBUS<n>:SENT:SIGNAl<s>:DISPlay"](#) on page 909
 - [":SBUS<n>:SENT:SIGNAl<s>:LENGth"](#) on page 910

- **":SBUS<n>:SENT:SIGNal<s>:MULTIplier"** on page 912
- **":SBUS<n>:SENT:SIGNal<s>:OFFSet"** on page 913
- **":SBUS<n>:SENT:SIGNal<s>:START"** on page 916
- **":SBUS<n>:SENT:SOURce"** on page 918
- **":SBUS<n>:SENT:TOLerance"** on page 920
- **":SBUS<n>:SENT:TRIGger"** on page 921
- **":SBUS<n>:SENT:TRIGger:FAST:DATA"** on page 923
- **":SBUS<n>:SENT:TRIGger:SLOW:DATA"** on page 924
- **":SBUS<n>:SENT:TRIGger:SLOW:ID"** on page 926
- **":SBUS<n>:SENT:TRIGger:SLOW:ILENght"** on page 928
- **":SBUS<n>:SENT:TRIGger:TOLerance"** on page 929

:SBUS<n>:SENT:SIGNAl<s>:START

N (see [page 1384](#))

Command Syntax :SBUS<n>:SENT:SIGNAl<s>:START <position>

<s> ::= 1-6, in NR1 format.

<position> ::= from 0-23, in NR1 format.

The :SBUS<n>:SENT:SIGNAl<s>:START command specifies the starting bit of the Fast Signal being defined.

Fast Signal definition examples:

Example 1: Start Bit # = 13, # of bits = 8, Nibble Order = LSN First

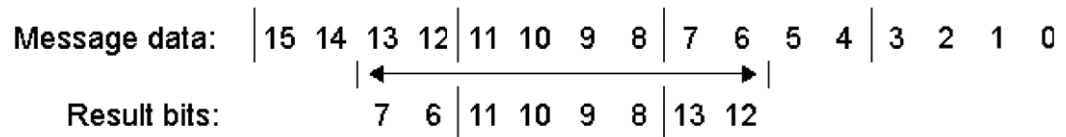

Example 2: Start Bit # = 10, # of bits = 5, Nibble Order = MSN First

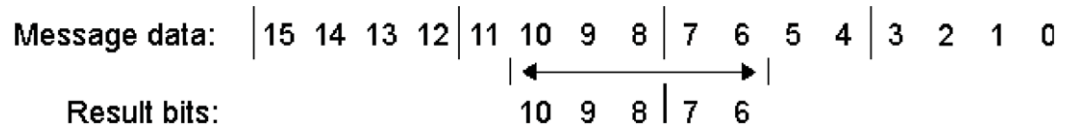

Query Syntax :SBUS<n>:SENT:SIGNAl<s>:START?

The :SBUS<n>:SENT:SIGNAl<s>:START? query returns the Fast Signal starting bit setting.

Return Format <position><NL>

<position> ::= from 0-23, in NR1 format.

- See Also**
- [":SBUS<n>:SENT:CLOCK"](#) on page 900
 - [":SBUS<n>:SENT:CRC"](#) on page 901
 - [":SBUS<n>:SENT:DISPlay"](#) on page 902
 - [":SBUS<n>:SENT:FORMat"](#) on page 904
 - [":SBUS<n>:SENT:IDLE"](#) on page 906
 - [":SBUS<n>:SENT:LENGth"](#) on page 907
 - [":SBUS<n>:SENT:PPULse"](#) on page 908
 - [":SBUS<n>:SENT:SIGNAl<s>:DISPlay"](#) on page 909
 - [":SBUS<n>:SENT:SIGNAl<s>:LENGth"](#) on page 910

- **":SBUS<n>:SENT:SIGNAl<s>:MULTIplier"** on page 912
- **":SBUS<n>:SENT:SIGNAl<s>:OFFSet"** on page 913
- **":SBUS<n>:SENT:SIGNAl<s>:ORDer"** on page 914
- **":SBUS<n>:SENT:SOURce"** on page 918
- **":SBUS<n>:SENT:TOLerance"** on page 920
- **":SBUS<n>:SENT:TRIGger"** on page 921
- **":SBUS<n>:SENT:TRIGger:FAST:DATA"** on page 923
- **":SBUS<n>:SENT:TRIGger:SLOW:DATA"** on page 924
- **":SBUS<n>:SENT:TRIGger:SLOW:ID"** on page 926
- **":SBUS<n>:SENT:TRIGger:SLOW:ILENgtH"** on page 928
- **":SBUS<n>:SENT:TRIGger:TOLerance"** on page 929

:SBUS<n>:SENT:SOURce

N (see [page 1384](#))

Command Syntax :SBUS<n>:SENT:SOURce <source>

<source> ::= {CHANnel<n> | DIGital<d>}

<n> ::= 1 to (# analog channels) in NR1 format

<d> ::= 0 to (# digital channels - 1) in NR1 format

The :SBUS<n>:SENT:SOURce command specifies the input channel for SENT decode and triggering.

Query Syntax :SBUS<n>:SENT:SOURce?

The :SBUS<n>:SENT:SOURce? query returns the specified SENT input source.

Return Format <source><NL>

<source> ::= {CHANnel<n> | DIGital<d>}

<n> ::= 1 to (# analog channels) in NR1 format

<d> ::= 0 to (# digital channels - 1) in NR1 format

- See Also**
- [":SBUS<n>:SENT:CLOCK"](#) on page 900
 - [":SBUS<n>:SENT:CRC"](#) on page 901
 - [":SBUS<n>:SENT:DISPlay"](#) on page 902
 - [":SBUS<n>:SENT:FORMat"](#) on page 904
 - [":SBUS<n>:SENT:IDLE"](#) on page 906
 - [":SBUS<n>:SENT:LENGth"](#) on page 907
 - [":SBUS<n>:SENT:PPULse"](#) on page 908
 - [":SBUS<n>:SENT:SIGNal<s>:DISPlay"](#) on page 909
 - [":SBUS<n>:SENT:SIGNal<s>:LENGth"](#) on page 910
 - [":SBUS<n>:SENT:SIGNal<s>:MULTIplier"](#) on page 912
 - [":SBUS<n>:SENT:SIGNal<s>:OFFSet"](#) on page 913
 - [":SBUS<n>:SENT:SIGNal<s>:ORDer"](#) on page 914
 - [":SBUS<n>:SENT:SIGNal<s>:START"](#) on page 916
 - [":SBUS<n>:SENT:TOLerance"](#) on page 920
 - [":SBUS<n>:SENT:TRIGger"](#) on page 921
 - [":SBUS<n>:SENT:TRIGger:FAST:DATA"](#) on page 923
 - [":SBUS<n>:SENT:TRIGger:SLOW:DATA"](#) on page 924
 - [":SBUS<n>:SENT:TRIGger:SLOW:ID"](#) on page 926
 - [":SBUS<n>:SENT:TRIGger:SLOW:ILENgth"](#) on page 928

- [":SBUS<n>:SENT:TRIGger:TOLerance"](#) on page 929

:SBUS<n>:SENT:TOLerance

N (see [page 1384](#))

Command Syntax :SBUS<n>:SENT:TOLerance <percent>

<percent> ::= from 3-30, in NR1 format.

The :SBUS<n>:SENT:TOLerance command specifies the tolerance for determining whether the sync pulse is valid. Valid values range from 3% to 30%.

Query Syntax :SBUS<n>:SENT:TOLerance?

The :SBUS<n>:SENT:TOLerance? query returns the tolerance setting.

Return Format <percent><NL>

<percent> ::= from 3-30, in NR1 format.

- See Also**
- [":SBUS<n>:SENT:CLOCK"](#) on page 900
 - [":SBUS<n>:SENT:CRC"](#) on page 901
 - [":SBUS<n>:SENT:DISPlay"](#) on page 902
 - [":SBUS<n>:SENT:FORMat"](#) on page 904
 - [":SBUS<n>:SENT:IDLE"](#) on page 906
 - [":SBUS<n>:SENT:LENGth"](#) on page 907
 - [":SBUS<n>:SENT:PPULse"](#) on page 908
 - [":SBUS<n>:SENT:SIGNal<s>:DISPlay"](#) on page 909
 - [":SBUS<n>:SENT:SIGNal<s>:LENGth"](#) on page 910
 - [":SBUS<n>:SENT:SIGNal<s>:MULTIplier"](#) on page 912
 - [":SBUS<n>:SENT:SIGNal<s>:OFFSet"](#) on page 913
 - [":SBUS<n>:SENT:SIGNal<s>:ORDer"](#) on page 914
 - [":SBUS<n>:SENT:SIGNal<s>:START"](#) on page 916
 - [":SBUS<n>:SENT:SOURce"](#) on page 918
 - [":SBUS<n>:SENT:TRIGger"](#) on page 921
 - [":SBUS<n>:SENT:TRIGger:FAST:DATA"](#) on page 923
 - [":SBUS<n>:SENT:TRIGger:SLOW:DATA"](#) on page 924
 - [":SBUS<n>:SENT:TRIGger:SLOW:ID"](#) on page 926
 - [":SBUS<n>:SENT:TRIGger:SLOW:ILENgth"](#) on page 928
 - [":SBUS<n>:SENT:TRIGger:TOLerance"](#) on page 929

:SBUS<n>:SENT:TRIGger

N (see [page 1384](#))

Command Syntax :SBUS<n>:SENT:TRIGger <mode>

```
<mode> ::= {SFCMessage | SSCMessage | FCData | SCMid | SCData
            | TOLerror | FCCerror | SCCerror | CRCerror | PPERror | SSPerror}
```

The :SBUS<n>:SENT:TRIGger command specifies the SENT trigger mode:

- SFCMessage – triggers on the start of any Fast Channel Message (after 56 Synchronization/Calibration ticks).
- SSCMessage – trigger on the start of any Slow Channel Message.
- FCData – triggers on a Fast Channel Message when the Status & Communication nibble and the data nibbles match the values entered using additional softkeys.
- SCMid – triggers when a Slow Channel Message ID matches the value entered using additional softkeys.
- SCData – triggers when a Slow Channel Message ID and Data field both match the values entered using additional softkeys.
- TOLerror – triggers when the sync pulse width varies from the nominal value by greater than the entered percentage.
- FCCerror – triggers on any Fast Channel Message CRC error.
- SCCerror – triggers on any Slow Channel Message CRC error.
- CRCerror – triggers on any CRC error, Fast or Slow.
- PPERror – triggers if a nibble is either too wide or too narrow (for example, data nibble < 12 (11.5) or > 27 (27.5) ticks wide). Sync, S&C, data, or checksum pulse periods are checked.
- SSPerror – triggers on a sync pulse whose width varies from the previous sync pulse's width by greater than 1/64 (1.5625%, as defined in the SENT specification).

Query Syntax :SBUS<n>:SENT:TRIGger?

The :SBUS<n>:SENT:TRIGger? query returns the trigger mode setting.

Return Format <mode><NL>

```
<mode> ::= {SFCM | SSCM | FCD | SCM | SCD | TOL | FCC | SCC | CRC
            | PPER | SSP}
```

- See Also**
- [":SBUS<n>:SENT:CLOCK"](#) on page 900
 - [":SBUS<n>:SENT:CRC"](#) on page 901
 - [":SBUS<n>:SENT:DISPlay"](#) on page 902
 - [":SBUS<n>:SENT:FORMat"](#) on page 904
 - [":SBUS<n>:SENT:IDLE"](#) on page 906

- **":SBUS<n>:SENT:LENGth"** on page 907
- **":SBUS<n>:SENT:PPULse"** on page 908
- **":SBUS<n>:SENT:SIGNal<s>:DISPlay"** on page 909
- **":SBUS<n>:SENT:SIGNal<s>:LENGth"** on page 910
- **":SBUS<n>:SENT:SIGNal<s>:MULTIplier"** on page 912
- **":SBUS<n>:SENT:SIGNal<s>:OFFSet"** on page 913
- **":SBUS<n>:SENT:SIGNal<s>:ORDer"** on page 914
- **":SBUS<n>:SENT:SIGNal<s>:STARt"** on page 916
- **":SBUS<n>:SENT:SOURce"** on page 918
- **":SBUS<n>:SENT:TOLerance"** on page 920
- **":SBUS<n>:SENT:TRIGger:FAST:DATA"** on page 923
- **":SBUS<n>:SENT:TRIGger:SLOW:DATA"** on page 924
- **":SBUS<n>:SENT:TRIGger:SLOW:ID"** on page 926
- **":SBUS<n>:SENT:TRIGger:SLOW:ILENght"** on page 928
- **":SBUS<n>:SENT:TRIGger:TOLerance"** on page 929

:SBUS<n>:SENT:TRIGger:FAST:DATA

N (see [page 1384](#))

Command Syntax :SBUS<n>:SENT:TRIGger:FAST:DATA <string>

<string> ::= "nnnn..." where n ::= {0 | 1 | X}

<string> ::= "0xn..." where n ::= {0,...,9 | A,...,F | X | \$}

The :SBUS<n>:SENT:TRIGger:FAST:DATA command specifies the status and data nibbles that will be triggered on when the FCData trigger mode is chosen.

Query Syntax :SBUS<n>:SENT:TRIGger:FAST:DATA?

The :SBUS<n>:SENT:TRIGger:FAST:DATA? query returns the fast channel data trigger setting.

Return Format <string><NL>

<string> ::= "nnnn..." where n ::= {0 | 1 | X}

<string> ::= "0xn..." where n ::= {0,...,9 | A,...,F | X | \$}

- See Also**
- [":SBUS<n>:SENT:CLOCK"](#) on page 900
 - [":SBUS<n>:SENT:CRC"](#) on page 901
 - [":SBUS<n>:SENT:DISPlay"](#) on page 902
 - [":SBUS<n>:SENT:FORMat"](#) on page 904
 - [":SBUS<n>:SENT:IDLE"](#) on page 906
 - [":SBUS<n>:SENT:LENGth"](#) on page 907
 - [":SBUS<n>:SENT:PPULse"](#) on page 908
 - [":SBUS<n>:SENT:SIGNal<s>:DISPlay"](#) on page 909
 - [":SBUS<n>:SENT:SIGNal<s>:LENGth"](#) on page 910
 - [":SBUS<n>:SENT:SIGNal<s>:MULTIplier"](#) on page 912
 - [":SBUS<n>:SENT:SIGNal<s>:OFFSet"](#) on page 913
 - [":SBUS<n>:SENT:SIGNal<s>:ORDer"](#) on page 914
 - [":SBUS<n>:SENT:SIGNal<s>:START"](#) on page 916
 - [":SBUS<n>:SENT:SOURce"](#) on page 918
 - [":SBUS<n>:SENT:TOLerance"](#) on page 920
 - [":SBUS<n>:SENT:TRIGger"](#) on page 921
 - [":SBUS<n>:SENT:TRIGger:SLOW:DATA"](#) on page 924
 - [":SBUS<n>:SENT:TRIGger:SLOW:ID"](#) on page 926
 - [":SBUS<n>:SENT:TRIGger:SLOW:ILENgth"](#) on page 928
 - [":SBUS<n>:SENT:TRIGger:TOLerance"](#) on page 929

:SBUS<n>:SENT:TRIGger:SLOW:DATA

N (see [page 1384](#))

Command Syntax :SBUS<n>:SENT:TRIGger:SLOW:DATA <data>

<data> ::= when ILENgth = SHORt, from -1 (don't care) to 65535, in NR1 format.

<data> ::= when ILENgth = LONG, from -1 (don't care) to 4095, in NR1 format.

The :SBUS<n>:SENT:TRIGger:SLOW:DATA command specifies the data to trigger on for the Slow Channel Message ID and Data trigger mode.

Query Syntax :SBUS<n>:SENT:TRIGger:SLOW:DATA?

The :SBUS<n>:SENT:TRIGger:SLOW:DATA? query returns the data value setting for the slow channel ID and data trigger.

Return Format <data><NL>

<data> ::= when ILENgth = SHORt, from -1 (don't care) to 65535, in NR1 format.

<data> ::= when ILENgth = LONG, from -1 (don't care) to 4095, in NR1 format.

- See Also**
- [":SBUS<n>:SENT:CLOCK"](#) on page 900
 - [":SBUS<n>:SENT:CRC"](#) on page 901
 - [":SBUS<n>:SENT:DISPlay"](#) on page 902
 - [":SBUS<n>:SENT:FORMat"](#) on page 904
 - [":SBUS<n>:SENT:IDLE"](#) on page 906
 - [":SBUS<n>:SENT:LENgth"](#) on page 907
 - [":SBUS<n>:SENT:PPULse"](#) on page 908
 - [":SBUS<n>:SENT:SIGNal<s>:DISPlay"](#) on page 909
 - [":SBUS<n>:SENT:SIGNal<s>:LENgth"](#) on page 910
 - [":SBUS<n>:SENT:SIGNal<s>:MULTiplier"](#) on page 912
 - [":SBUS<n>:SENT:SIGNal<s>:OFFSet"](#) on page 913
 - [":SBUS<n>:SENT:SIGNal<s>:ORDer"](#) on page 914
 - [":SBUS<n>:SENT:SIGNal<s>:START"](#) on page 916
 - [":SBUS<n>:SENT:SOURce"](#) on page 918
 - [":SBUS<n>:SENT:TOLerance"](#) on page 920
 - [":SBUS<n>:SENT:TRIGger"](#) on page 921
 - [":SBUS<n>:SENT:TRIGger:FAST:DATA"](#) on page 923
 - [":SBUS<n>:SENT:TRIGger:SLOW:ID"](#) on page 926

- `":SBUS<n>:SENT:TRIGger:SLOW:ILENgtH"` on page 928
- `":SBUS<n>:SENT:TRIGger:TOLerance"` on page 929

:SBUS<n>:SENT:TRIGger:SLOW:ID

N (see [page 1384](#))

Command Syntax :SBUS<n>:SENT:TRIGger:SLOW:ID <id>

<id> ::= when ILENgth = SHORT, from -1 (don't care) to 15, in NR1 format
.

<id> ::= when ILENgth = LONG, from -1 (don't care) to 255, in NR1 format
.

The :SBUS<n>:SENT:TRIGger:SLOW:ID command specifies the ID to trigger on for the "Slow Channel Message ID" and "Slow Channel Message ID & Data" trigger modes. The ID can be from -1 (don't care) to 255 (depending on the message length).

Query Syntax :SBUS<n>:SENT:TRIGger:SLOW:ID?

The :SBUS<n>:SENT:TRIGger:SLOW:ID? query returns the slow channel ID setting.

Return Format <id><NL>

<id> ::= when ILENgth = SHORT, from -1 (don't care) to 15, in NR1 format
.

<id> ::= when ILENgth = LONG, from -1 (don't care) to 255, in NR1 format
.

- See Also**
- [":SBUS<n>:SENT:CLOCK"](#) on page 900
 - [":SBUS<n>:SENT:CRC"](#) on page 901
 - [":SBUS<n>:SENT:DISPlay"](#) on page 902
 - [":SBUS<n>:SENT:FORMat"](#) on page 904
 - [":SBUS<n>:SENT:IDLE"](#) on page 906
 - [":SBUS<n>:SENT:LENgth"](#) on page 907
 - [":SBUS<n>:SENT:PPULse"](#) on page 908
 - [":SBUS<n>:SENT:SIGNal<s>:DISPlay"](#) on page 909
 - [":SBUS<n>:SENT:SIGNal<s>:LENgth"](#) on page 910
 - [":SBUS<n>:SENT:SIGNal<s>:MULTiplier"](#) on page 912
 - [":SBUS<n>:SENT:SIGNal<s>:OFFSet"](#) on page 913
 - [":SBUS<n>:SENT:SIGNal<s>:ORDer"](#) on page 914
 - [":SBUS<n>:SENT:SIGNal<s>:START"](#) on page 916
 - [":SBUS<n>:SENT:SOURce"](#) on page 918
 - [":SBUS<n>:SENT:TOLerance"](#) on page 920
 - [":SBUS<n>:SENT:TRIGger"](#) on page 921
 - [":SBUS<n>:SENT:TRIGger:FAST:DATA"](#) on page 923
 - [":SBUS<n>:SENT:TRIGger:SLOW:DATA"](#) on page 924

- `":SBUS<n>:SENT:TRIGger:SLOW:ILENgtH"` on page 928
- `":SBUS<n>:SENT:TRIGger:TOLerance"` on page 929

:SBUS<n>:SENT:TRIGger:SLOW:ILENgth

N (see [page 1384](#))

Command Syntax :SBUS<n>:SENT:TRIGger:SLOW:ILENgth <length>
 <length> ::= {SHORT | LONG}

The :SBUS<n>:SENT:TRIGger:SLOW:ILENgth command specifies the ID and data lengths for the Slow Message Enhanced messages. Either "SHORT" for the 4-bit ID, 16-bit data format, or "LONG" for the 8-bit ID, 12-bit data format.

Query Syntax :SBUS<n>:SENT:TRIGger:SLOW:ILENgth?

The :SBUS<n>:SENT:TRIGger:SLOW:ILENgth? query returns the ID and data length setting.

Return Format <length><NL>
 <length> ::= {SHOR | LONG}

- See Also**
- [":SBUS<n>:SENT:CLOCK"](#) on page 900
 - [":SBUS<n>:SENT:CRC"](#) on page 901
 - [":SBUS<n>:SENT:DISPlay"](#) on page 902
 - [":SBUS<n>:SENT:FORMat"](#) on page 904
 - [":SBUS<n>:SENT:IDLE"](#) on page 906
 - [":SBUS<n>:SENT:LENgth"](#) on page 907
 - [":SBUS<n>:SENT:PPULse"](#) on page 908
 - [":SBUS<n>:SENT:SIGNal<s>:DISPlay"](#) on page 909
 - [":SBUS<n>:SENT:SIGNal<s>:LENgth"](#) on page 910
 - [":SBUS<n>:SENT:SIGNal<s>:MULTIplier"](#) on page 912
 - [":SBUS<n>:SENT:SIGNal<s>:OFFSet"](#) on page 913
 - [":SBUS<n>:SENT:SIGNal<s>:ORDer"](#) on page 914
 - [":SBUS<n>:SENT:SIGNal<s>:START"](#) on page 916
 - [":SBUS<n>:SENT:SOURce"](#) on page 918
 - [":SBUS<n>:SENT:TOLerance"](#) on page 920
 - [":SBUS<n>:SENT:TRIGger"](#) on page 921
 - [":SBUS<n>:SENT:TRIGger:FAST:DATA"](#) on page 923
 - [":SBUS<n>:SENT:TRIGger:SLOW:DATA"](#) on page 924
 - [":SBUS<n>:SENT:TRIGger:SLOW:ID"](#) on page 926
 - [":SBUS<n>:SENT:TRIGger:TOLerance"](#) on page 929

:SBUS<n>:SENT:TRIGger:TOLerance

N (see [page 1384](#))

Command Syntax :SBUS<n>:SENT:TRIGger:TOLerance <percent>
 <percent> ::= from 1-28, in NR1 format.

The :SBUS<n>:SENT:TRIGger:TOLerance command specifies the tolerance variation that is considered a violation.

The trigger tolerance can be up to the :SBUS<n>:SENT:TOLerance setting minus two percent. For example, after sending ":SBUS1:SENT:TOLerance 20", the :SBUS1:SENT:TRIGger:TOLerance setting can be from 1 to 18.

Query Syntax :SBUS<n>:SENT:TRIGger:TOLerance?

The :SBUS<n>:SENT:TRIGger:TOLerance? query returns tolerance variation percent setting.

Return Format <percent><NL>
 <percent> ::= from 1-28, in NR1 format.

- See Also**
- [":SBUS<n>:SENT:CLOCK"](#) on page 900
 - [":SBUS<n>:SENT:CRC"](#) on page 901
 - [":SBUS<n>:SENT:DISPlay"](#) on page 902
 - [":SBUS<n>:SENT:FORMat"](#) on page 904
 - [":SBUS<n>:SENT:IDLE"](#) on page 906
 - [":SBUS<n>:SENT:LENGth"](#) on page 907
 - [":SBUS<n>:SENT:PPULse"](#) on page 908
 - [":SBUS<n>:SENT:SIGNal<s>:DISPlay"](#) on page 909
 - [":SBUS<n>:SENT:SIGNal<s>:LENGth"](#) on page 910
 - [":SBUS<n>:SENT:SIGNal<s>:MULTiplier"](#) on page 912
 - [":SBUS<n>:SENT:SIGNal<s>:OFFSet"](#) on page 913
 - [":SBUS<n>:SENT:SIGNal<s>:ORDer"](#) on page 914
 - [":SBUS<n>:SENT:SIGNal<s>:START"](#) on page 916
 - [":SBUS<n>:SENT:SOURce"](#) on page 918
 - [":SBUS<n>:SENT:TOLerance"](#) on page 920
 - [":SBUS<n>:SENT:TRIGger"](#) on page 921
 - [":SBUS<n>:SENT:TRIGger:FAST:DATA"](#) on page 923
 - [":SBUS<n>:SENT:TRIGger:SLOW:DATA"](#) on page 924
 - [":SBUS<n>:SENT:TRIGger:SLOW:ID"](#) on page 926
 - [":SBUS<n>:SENT:TRIGger:SLOW:ILENgtH"](#) on page 928

:SBUS<n>:SPI Commands

NOTE

These commands are only valid when the low-speed IIC and SPI serial decode option (Option LSS) has been licensed.

Table 121 :SBUS<n>:SPI Commands Summary

Command	Query	Options and Query Returns
:SBUS<n>:SPI:BITOrder <order> (see page 932)	:SBUS<n>:SPI:BITOrder ? (see page 932)	<order> ::= {LSBFirst MSBFirst}
:SBUS<n>:SPI:CLOCK:SL OPe <slope> (see page 933)	:SBUS<n>:SPI:CLOCK:SL OPe? (see page 933)	<slope> ::= {NEGative POSitive}
:SBUS<n>:SPI:CLOCK:TI Meout <time_value> (see page 934)	:SBUS<n>:SPI:CLOCK:TI Meout? (see page 934)	<time_value> ::= time in seconds in NR3 format
:SBUS<n>:SPI:FRAMing <value> (see page 935)	:SBUS<n>:SPI:FRAMing? (see page 935)	<value> ::= {CHIPselect {NCHipselect NOTC} TIMEout}
:SBUS<n>:SPI:SOURce:C LOCK <source> (see page 936)	:SBUS<n>:SPI:SOURce:C LOCK? (see page 936)	<value> ::= {CHANnel<n> EXTernal} for the DSO models <value> ::= {CHANnel<n> DIGital<d>} for the MSO models <n> ::= 1 to (# analog channels) in NR1 format <d> ::= 0 to (# digital channels - 1) in NR1 format
:SBUS<n>:SPI:SOURce:F RAME <source> (see page 937)	:SBUS<n>:SPI:SOURce:F RAME? (see page 937)	<value> ::= {CHANnel<n> EXTernal} for the DSO models <value> ::= {CHANnel<n> DIGital<d>} for the MSO models <n> ::= 1 to (# analog channels) in NR1 format <d> ::= 0 to (# digital channels - 1) in NR1 format
:SBUS<n>:SPI:SOURce:M ISO <source> (see page 938)	:SBUS<n>:SPI:SOURce:M ISO? (see page 938)	<value> ::= {CHANnel<n> EXTernal} for the DSO models <value> ::= {CHANnel<n> DIGital<d>} for the MSO models <n> ::= 1 to (# analog channels) in NR1 format <d> ::= 0 to (# digital channels - 1) in NR1 format

Table 121 :SBUS<n>:SPI Commands Summary (continued)

Command	Query	Options and Query Returns
:SBUS<n>:SPI:SOURce:MOSI <source> (see page 939)	:SBUS<n>:SPI:SOURce:MOSI? (see page 939)	<value> ::= {CHANnel<n> EXTErnal} for the DSO models <value> ::= {CHANnel<n> DIGital<d>} for the MSO models <n> ::= 1 to (# analog channels) in NR1 format <d> ::= 0 to (# digital channels - 1) in NR1 format
:SBUS<n>:SPI:TRIGger:PATtern:MISO:DATA <string> (see page 940)	:SBUS<n>:SPI:TRIGger:PATtern:MISO:DATA? (see page 940)	<string> ::= "nn...n" where n ::= {0 1 X \$} <string> ::= "0xnn...n" where n ::= {0,...,9 A,...,F X \$}
:SBUS<n>:SPI:TRIGger:PATtern:MISO:WIDTh <width> (see page 941)	:SBUS<n>:SPI:TRIGger:PATtern:MISO:WIDTh? (see page 941)	<width> ::= integer from 4 to 64 in NR1 format
:SBUS<n>:SPI:TRIGger:PATtern:MOSI:DATA <string> (see page 942)	:SBUS<n>:SPI:TRIGger:PATtern:MOSI:DATA? (see page 942)	<string> ::= "nn...n" where n ::= {0 1 X \$} <string> ::= "0xnn...n" where n ::= {0,...,9 A,...,F X \$}
:SBUS<n>:SPI:TRIGger:PATtern:MOSI:WIDTh <width> (see page 943)	:SBUS<n>:SPI:TRIGger:PATtern:MOSI:WIDTh? (see page 943)	<width> ::= integer from 4 to 64 in NR1 format
:SBUS<n>:SPI:TRIGger:TYPE <value> (see page 944)	:SBUS<n>:SPI:TRIGger:TYPE? (see page 944)	<value> ::= {MOSI MISO}
:SBUS<n>:SPI:WIDTh <word_width> (see page 945)	:SBUS<n>:SPI:WIDTh? (see page 945)	<word_width> ::= integer 4-16 in NR1 format

:SBUS<n>:SPI:BITOrder

N (see [page 1384](#))

Command Syntax :SBUS<n>:SPI:BITOrder <order>

<order> ::= {LSBFirst | MSBFirst}

The :SBUS<n>:SPI:BITOrder command selects the bit order, most significant bit first (MSB) or least significant bit first (LSB), used when displaying data in the serial decode waveform and in the Lister.

Query Syntax :SBUS<n>:SPI:BITOrder?

The :SBUS<n>:SPI:BITOrder? query returns the current SPI decode bit order.

Return Format <order><NL>

<order> ::= {LSBF | MSBF}

Errors • ["-241, Hardware missing"](#) on page 1343

- See Also** • ["Introduction to :SBUS<n> Commands"](#) on page 755
- [":SBUS<n>:MODE"](#) on page 759
 - [":SBUS<n>:SPI Commands"](#) on page 930

:SBUS<n>:SPI:CLOCK:SLOPe

N (see [page 1384](#))

Command Syntax :SBUS<n>:SPI:CLOCK:SLOPe <slope>

<slope> ::= {NEGative | POSitive}

The :SBUS<n>:SPI:CLOCK:SLOPe command specifies the rising edge (POSitive) or falling edge (NEGative) of the SPI clock source that will clock in the data.

Query Syntax :SBUS<n>:SPI:CLOCK:SLOPe?

The :SBUS<n>:SPI:CLOCK:SLOPe? query returns the current SPI clock source slope.

Return Format <slope><NL>

<slope> ::= {NEG | POS}

- See Also**
- ["Introduction to :TRIGger Commands"](#) on page 1097
 - [":SBUS<n>:SPI:CLOCK:TIMEout"](#) on page 934
 - [":SBUS<n>:SPI:SOURce:CLOCK"](#) on page 936

:SBUS<n>:SPI:CLOCK:TIMEout

N (see [page 1384](#))

Command Syntax :SBUS<n>:SPI:CLOCK:TIMEout <time_value>

<time_value> ::= time in seconds in NR3 format

The :SBUS<n>:SPI:CLOCK:TIMEout command sets the SPI signal clock timeout resource in seconds from 100 ns to 10 s when the :SBUS<n>:SPI:FRAMing command is set to TIMEout. The timer is used to frame a signal by a clock timeout.

Query Syntax :SBUS<n>:SPI:CLOCK:TIMEout?

The :SBUS<n>:SPI:CLOCK:TIMEout? query returns current SPI clock timeout setting.

Return Format <time_value><NL>

<time_value> ::= time in seconds in NR3 format

- See Also**
- ["Introduction to :TRIGger Commands"](#) on page 1097
 - [":SBUS<n>:SPI:CLOCK:SLOPe"](#) on page 933
 - [":SBUS<n>:SPI:SOURce:CLOCK"](#) on page 936
 - [":SBUS<n>:SPI:FRAMing"](#) on page 935

:SBUS<n>:SPI:FRAMing

N (see [page 1384](#))

Command Syntax :SBUS<n>:SPI:FRAMing <value>

<value> ::= {CHIPselect | {NCHipselect | NOTC} | TIMEout}

The :SBUS<n>:SPI:FRAMing command sets the SPI trigger framing value. If TIMEout is selected, the timeout value is set by the :SBUS<n>:SPI:CLOCK:TIMEout command.

NOTE

The NOTC value is deprecated. It is the same as NCHipselect.

Query Syntax :SBUS<n>:SPI:FRAMing?

The :SBUS<n>:SPI:FRAMing? query returns the current SPI framing value.

Return Format <value><NL>

<value> ::= {CHIP | NCH | TIM}

- See Also**
- ["Introduction to :TRIGger Commands"](#) on page 1097
 - [":TRIGger:MODE"](#) on page 1106
 - [":SBUS<n>:SPI:CLOCK:TIMEout"](#) on page 934
 - [":SBUS<n>:SPI:SOURce:FRAMe"](#) on page 937

:SBUS<n>:SPI:SOURce:CLOCK

N (see [page 1384](#))

Command Syntax :SBUS<n>:SPI:SOURce:CLOCK <source>

<source> ::= {CHANnel<n> | EXTernal} for the DSO models

<source> ::= {CHANnel<n> | DIGital<d>} for the MSO models

<n> ::= 1 to (# analog channels) in NR1 format

<d> ::= 0 to (# digital channels - 1) in NR1 format

The :SBUS<n>:SPI:SOURce:CLOCK command sets the source for the SPI serial clock.

Query Syntax :SBUS<n>:SPI:SOURce:CLOCK?

The :SBUS<n>:SPI:SOURce:CLOCK? query returns the current source for the SPI serial clock.

Return Format <source><NL>

- See Also**
- ["Introduction to :TRIGger Commands"](#) on page 1097
 - [":SBUS<n>:SPI:CLOCK:SLOPe"](#) on page 933
 - [":SBUS<n>:SPI:CLOCK:TIMEout"](#) on page 934
 - [":SBUS<n>:SPI:SOURce:FRAMe"](#) on page 937
 - [":SBUS<n>:SPI:SOURce:MOSI"](#) on page 939
 - [":SBUS<n>:SPI:SOURce:MISO"](#) on page 938

:SBUS<n>:SPI:SOURce:FRAMe

N (see [page 1384](#))

Command Syntax :SBUS<n>:SPI:SOURce:FRAMe <source>

<source> ::= {CHANnel<n> | EXTernal} for the DSO models

<source> ::= {CHANnel<n> | DIGital<d>} for the MSO models

<n> ::= 1 to (# analog channels) in NR1 format

<d> ::= 0 to (# digital channels - 1) in NR1 format

The :SBUS<n>:SPI:SOURce:FRAMe command sets the frame source when :SBUS<n>:SPI:FRAMing is set to CHIPselect or NOTChipselect.

Query Syntax :SBUS<n>:SPI:SOURce:FRAMe?

The :SBUS<n>:SPI:SOURce:FRAMe? query returns the current frame source for the SPI serial frame.

Return Format <source><NL>

- See Also**
- ["Introduction to :TRIGger Commands"](#) on page 1097
 - [":SBUS<n>:SPI:SOURce:CLOCK"](#) on page 936
 - [":SBUS<n>:SPI:SOURce:MOSI"](#) on page 939
 - [":SBUS<n>:SPI:SOURce:MISO"](#) on page 938
 - [":SBUS<n>:SPI:FRAMing"](#) on page 935

:SBUS<n>:SPI:SOURce:MISO

N (see [page 1384](#))

Command Syntax :SBUS<n>:SPI:SOURce:MISO <source>

<source> ::= {CHANnel<n> | EXTernal} for the DSO models

<source> ::= {CHANnel<n> | DIGital<d>} for the MSO models

<n> ::= 1 to (# analog channels) in NR1 format

<d> ::= 0 to (# digital channels - 1) in NR1 format

The :SBUS<n>:SPI:SOURce:MISO command sets the source for the SPI serial MISO data.

Query Syntax :SBUS<n>:SPI:SOURce:MISO?

The :SBUS<n>:SPI:SOURce:MISO? query returns the current source for the SPI serial MISO data.

Return Format <source><NL>

- See Also**
- ["Introduction to :TRIGger Commands"](#) on page 1097
 - [":SBUS<n>:SPI:SOURce:MOSI"](#) on page 939
 - [":SBUS<n>:SPI:SOURce:CLOCK"](#) on page 936
 - [":SBUS<n>:SPI:SOURce:FRAME"](#) on page 937
 - [":SBUS<n>:SPI:TRIGger:PATTern:MISO:DATA"](#) on page 940
 - [":SBUS<n>:SPI:TRIGger:PATTern:MOSI:DATA"](#) on page 942
 - [":SBUS<n>:SPI:TRIGger:PATTern:MISO:WIDTH"](#) on page 941
 - [":SBUS<n>:SPI:TRIGger:PATTern:MOSI:WIDTH"](#) on page 943

:SBUS<n>:SPI:SOURce:MOSI

N (see [page 1384](#))

Command Syntax :SBUS<n>:SPI:SOURce:MOSI <source>

<source> ::= {CHANnel<n> | EXTernal} for the DSO models

<source> ::= {CHANnel<n> | DIGital<d>} for the MSO models

<n> ::= 1 to (# analog channels) in NR1 format

<d> ::= 0 to (# digital channels - 1) in NR1 format

The :SBUS<n>:SPI:SOURce:MOSI command sets the source for the SPI serial MOSI data.

Query Syntax :SBUS<n>:SPI:SOURce:MOSI?

The :SBUS<n>:SPI:SOURce:MOSI? query returns the current source for the SPI serial MOSI data.

Return Format <source><NL>

- See Also**
- ["Introduction to :TRIGger Commands"](#) on page 1097
 - [":SBUS<n>:SPI:SOURce:MISO"](#) on page 938
 - [":SBUS<n>:SPI:SOURce:CLOCK"](#) on page 936
 - [":SBUS<n>:SPI:SOURce:FRAME"](#) on page 937
 - [":SBUS<n>:SPI:TRIGger:PATTern:MISO:DATA"](#) on page 940
 - [":SBUS<n>:SPI:TRIGger:PATTern:MOSI:DATA"](#) on page 942
 - [":SBUS<n>:SPI:TRIGger:PATTern:MISO:WIDTH"](#) on page 941
 - [":SBUS<n>:SPI:TRIGger:PATTern:MOSI:WIDTH"](#) on page 943

:SBUS<n>:SPI:TRIGger:PATtern:MISO:DATA

N (see [page 1384](#))

Command Syntax :SBUS<n>:SPI:TRIGger:PATtern:MISO:DATA <string>

<string> ::= "nn...n" where n ::= {0 | 1 | X | \$}

<string ::= "0xnn...n" where n ::= {0,...,9 | A,...,F | X | \$}

The :SBUS<n>:SPI:TRIGger:PATtern:MISO:DATA command defines the SPI data pattern resource according to the string parameter. This pattern, along with the data width, control the data pattern searched for in the data stream.

If the string parameter starts with "0x", it is a hexadecimal string made up of hexadecimal and X (don't care) characters; otherwise, it is a binary string made up of 0, 1, and X (don't care) characters.

NOTE

The :SBUS<n>:SPI:TRIGger:PATtern:MISO:WIDTH should be set before :SBUS<n>:SPI:TRIGger:PATtern:MISO:DATA.

Query Syntax :SBUS<n>:SPI:TRIGger:PATtern:MISO:DATA?

The :SBUS<n>:SPI:TRIGger:PATtern:MISO:DATA? query returns the current settings of the specified SPI data pattern resource in the binary string format.

Return Format <string><NL>

- See Also**
- ["Introduction to :TRIGger Commands"](#) on page 1097
 - [":SBUS<n>:SPI:TRIGger:PATtern:MISO:WIDTH"](#) on page 941
 - [":SBUS<n>:SPI:SOURce:MISO"](#) on page 938

:SBUS<n>:SPI:TRIGger:PATtern:MISO:WIDTh

N (see [page 1384](#))

Command Syntax :SBUS<n>:SPI:TRIGger:PATtern:MISO:WIDTh <width>
 <width> ::= integer from 4 to 64 in NR1 format

The :SBUS<n>:SPI:TRIGger:PATtern:MISO:WIDTh command sets the width of the SPI data pattern anywhere from 4 bits to 64 bits.

NOTE

The :SBUS<n>:SPI:TRIGger:PATtern:MISO:WIDTh should be set before :SBUS<n>:SPI:TRIGger:PATtern:MISO:DATA.

Query Syntax :SBUS<n>:SPI:TRIGger:PATtern:MISO:WIDTh?

The :SBUS<n>:SPI:TRIGger:PATtern:MISO:WIDTh? query returns the current SPI data pattern width setting.

Return Format <width><NL>
 <width> ::= integer from 4 to 64 in NR1 format

- See Also**
- ["Introduction to :TRIGger Commands"](#) on page 1097
 - [":SBUS<n>:SPI:TRIGger:PATtern:MISO:DATA"](#) on page 940
 - [":SBUS<n>:SPI:SOURce:MISO"](#) on page 938

:SBUS<n>:SPI:TRIGger:PATtern:MOSI:DATA

N (see [page 1384](#))

Command Syntax :SBUS<n>:SPI:TRIGger:PATtern:MOSI:DATA <string>

<string> ::= "nn...n" where n ::= {0 | 1 | X | \$}

<string ::= "0xnn...n" where n ::= {0,...,9 | A,...,F | X | \$}

The :SBUS<n>:SPI:TRIGger:PATtern:MOSI:DATA command defines the SPI data pattern resource according to the string parameter. This pattern, along with the data width, control the data pattern searched for in the data stream.

If the string parameter starts with "0x", it is a hexadecimal string made up of hexadecimal and X (don't care) characters; otherwise, it is a binary string made up of 0, 1, and X (don't care) characters.

NOTE

The :SBUS<n>:SPI:TRIGger:PATtern:MOSI:WIDTH should be set before :SBUS<n>:SPI:TRIGger:PATtern:MOSI:DATA.

Query Syntax :SBUS<n>:SPI:TRIGger:PATtern:MOSI:DATA?

The :SBUS<n>:SPI:TRIGger:PATtern:MOSI:DATA? query returns the current settings of the specified SPI data pattern resource in the binary string format.

Return Format <string><NL>

- See Also**
- ["Introduction to :TRIGger Commands"](#) on page 1097
 - [":SBUS<n>:SPI:TRIGger:PATtern:MOSI:WIDTH"](#) on page 943
 - [":SBUS<n>:SPI:SOURce:MOSI"](#) on page 939

:SBUS<n>:SPI:TRIGger:PATtern:MOSI:WIDTh

N (see [page 1384](#))

Command Syntax :SBUS<n>:SPI:TRIGger:PATtern:MOSI:WIDTh <width>
 <width> ::= integer from 4 to 64 in NR1 format

The :SBUS<n>:SPI:TRIGger:PATtern:MOSI:WIDTh command sets the width of the SPI data pattern anywhere from 4 bits to 64 bits.

NOTE

The :SBUS<n>:SPI:TRIGger:PATtern:MOSI:WIDTh should be set before :SBUS<n>:SPI:TRIGger:PATtern:MOSI:DATA.

Query Syntax :SBUS<n>:SPI:TRIGger:PATtern:MOSI:WIDTh?

The :SBUS<n>:SPI:TRIGger:PATtern:MOSI:WIDTh? query returns the current SPI data pattern width setting.

Return Format <width><NL>
 <width> ::= integer from 4 to 64 in NR1 format

- See Also**
- ["Introduction to :TRIGger Commands"](#) on page 1097
 - [":SBUS<n>:SPI:TRIGger:PATtern:MOSI:DATA"](#) on page 942
 - [":SBUS<n>:SPI:SOURce:MOSI"](#) on page 939

:SBUS<n>:SPI:TRIGger:TYPE

N (see [page 1384](#))

Command Syntax :SBUS<n>:SPI:TRIGger:TYPE <value>

<value> ::= {MOSI | MISO}

The :SBUS<n>:SPI:TRIGger:TYPE command specifies whether the SPI trigger will be on the MOSI data or the MISO data.

When triggering on MOSI data, the data value is specified by the :SBUS<n>:SPI:TRIGger:PATtern:MOSI:DATA and :SBUS<n>:SPI:TRIGger:PATtern:MOSI:WIDTH commands.

When triggering on MISO data, the data value is specified by the :SBUS<n>:SPI:TRIGger:PATtern:MISO:DATA and :SBUS<n>:SPI:TRIGger:PATtern:MISO:WIDTH commands.

Query Syntax :SBUS<n>:SPI:TRIGger:TYPE?

The :SBUS<n>:SPI:TRIGger:TYPE? query returns the current SPI trigger type setting.

Return Format <value><NL>

<value> ::= {MOSI | MISO}

- See Also**
- ["Introduction to :TRIGger Commands"](#) on page 1097
 - [":SBUS<n>:SPI:SOURce:MOSI"](#) on page 939
 - [":SBUS<n>:SPI:SOURce:MISO"](#) on page 938
 - [":SBUS<n>:SPI:TRIGger:PATtern:MISO:DATA"](#) on page 940
 - [":SBUS<n>:SPI:TRIGger:PATtern:MOSI:DATA"](#) on page 942
 - [":SBUS<n>:SPI:TRIGger:PATtern:MISO:WIDTH"](#) on page 941
 - [":SBUS<n>:SPI:TRIGger:PATtern:MOSI:WIDTH"](#) on page 943
 - [":TRIGger:MODE"](#) on page 1106

:SBUS<n>:SPI:WIDTh

N (see [page 1384](#))

Command Syntax :SBUS<n>:SPI:WIDTh <word_width>

<word_width> ::= integer 4-16 in NR1 format

The :SBUS<n>:SPI:WIDTh command determines the number of bits in a word of data for SPI.

Query Syntax :SBUS<n>:SPI:WIDTh?

The :SBUS<n>:SPI:WIDTh? query returns the current SPI decode word width.

Return Format <word_width><NL>

<word_width> ::= integer 4-16 in NR1 format

Errors • ["-241, Hardware missing"](#) on page 1343

See Also • ["Introduction to :SBUS<n> Commands"](#) on page 755
 • [":SBUS<n>:MODE"](#) on page 759
 • [":SBUS<n>:SPI Commands"](#) on page 930

:SBUS<n>:UART Commands

NOTE

These commands are only valid when the UART/RS-232 triggering and serial decode option (Option 232) has been licensed.

Table 122: :SBUS<n>:UART Commands Summary

Command	Query	Options and Query Returns
:SBUS<n>:UART:BASE <base> (see page 949)	:SBUS<n>:UART:BASE? (see page 949)	<base> ::= {ASCIi BINary HEX}
:SBUS<n>:UART:BAUDrate <baudrate> (see page 950)	:SBUS<n>:UART:BAUDrate? (see page 950)	<baudrate> ::= integer from 100 to 8000000
:SBUS<n>:UART:BITorder <bitorder> (see page 951)	:SBUS<n>:UART:BITorder? (see page 951)	<bitorder> ::= {LSBFirst MSBFirst}
n/a	:SBUS<n>:UART:COUNT:ERRor? (see page 952)	<frame_count> ::= integer in NR1 format
:SBUS<n>:UART:COUNT:RESet (see page 953)	n/a	n/a
n/a	:SBUS<n>:UART:COUNT:RXFrames? (see page 954)	<frame_count> ::= integer in NR1 format
n/a	:SBUS<n>:UART:COUNT:TXFrames? (see page 955)	<frame_count> ::= integer in NR1 format
:SBUS<n>:UART:FRAMing <value> (see page 956)	:SBUS<n>:UART:FRAMing? (see page 956)	<value> ::= {OFF <decimal> <nondecimal>} <decimal> ::= 8-bit integer from 0-255 (0x00-0xff) <nondecimal> ::= #Hnn where n ::= {0,...,9 A,...,F} for hexadecimal <nondecimal> ::= #Bnn...n where n ::= {0 1} for binary
:SBUS<n>:UART:PARity <parity> (see page 957)	:SBUS<n>:UART:PARity? (see page 957)	<parity> ::= {EVEN ODD NONE}
:SBUS<n>:UART:POLarity <polarity> (see page 958)	:SBUS<n>:UART:POLarity? (see page 958)	<polarity> ::= {HIGH LOW}

Table 122 :SBUS<n>:UART Commands Summary (continued)

Command	Query	Options and Query Returns
:SBUS<n>:UART:SOURce: RX <source> (see page 959)	:SBUS<n>:UART:SOURce: RX? (see page 959)	<source> ::= {CHANnel<n> EXTernal} for DSO models <source> ::= {CHANnel<n> DIGital<d>} for MSO models <n> ::= 1 to (# analog channels) in NR1 format <d> ::= 0 to (# digital channels - 1) in NR1 format
:SBUS<n>:UART:SOURce: TX <source> (see page 960)	:SBUS<n>:UART:SOURce: TX? (see page 960)	<source> ::= {CHANnel<n> EXTernal} for DSO models <source> ::= {CHANnel<n> DIGital<d>} for MSO models <n> ::= 1 to (# analog channels) in NR1 format <d> ::= 0 to (# digital channels - 1) in NR1 format
:SBUS<n>:UART:TRIGger :BASE <base> (see page 961)	:SBUS<n>:UART:TRIGger :BASE? (see page 961)	<base> ::= {ASCii HEX}
:SBUS<n>:UART:TRIGger :BURSt <value> (see page 962)	:SBUS<n>:UART:TRIGger :BURSt? (see page 962)	<value> ::= {OFF 1 to 4096 in NR1 format}
:SBUS<n>:UART:TRIGger :DATA <value> (see page 963)	:SBUS<n>:UART:TRIGger :DATA? (see page 963)	<value> ::= 8-bit integer from 0-255 (0x00-0xff) in decimal, <hexadecimal>, <binary>, or <quoted_string> format <hexadecimal> ::= #Hnn where n ::= {0,...,9 A,...,F} for hexadecimal <binary> ::= #Bnn...n where n ::= {0 1} for binary <quoted_string> ::= any of the 128 valid 7-bit ASCII characters (or standard abbreviations)
:SBUS<n>:UART:TRIGger :IDLE <time_value> (see page 964)	:SBUS<n>:UART:TRIGger :IDLE? (see page 964)	<time_value> ::= time from 1 us to 10 s in NR3 format
:SBUS<n>:UART:TRIGger :QUALifier <value> (see page 965)	:SBUS<n>:UART:TRIGger :QUALifier? (see page 965)	<value> ::= {EQUal NOTequal GREaterthan LESSthan}

Table 122 :SBUS<n>:UART Commands Summary (continued)

Command	Query	Options and Query Returns
:SBUS<n>:UART:TRIGger :TYPE <value> (see page 966)	:SBUS<n>:UART:TRIGger :TYPE? (see page 966)	<value> ::= {RStArt RStOp RDATA RD1 RD0 RDX PARityerror TStArt TStOp TDATA TD1 TD0 TDX}
:SBUS<n>:UART:WIDTh <width> (see page 967)	:SBUS<n>:UART:WIDTh? (see page 967)	<width> ::= {5 6 7 8 9}

:SBUS<n>:UART:BASE

N (see [page 1384](#))

Command Syntax :SBUS<n>:UART:BASE <base>

<base> ::= {ASCIi | BINary | HEX}

The :SBUS<n>:UART:BASE command determines the base to use for the UART decode and Lister display.

Query Syntax :SBUS<n>:UART:BASE?

The :SBUS<n>:UART:BASE? query returns the current UART decode and Lister base setting.

Return Format <base><NL>

<base> ::= {ASCIi | BINary | HEX}

Errors • ["-241, Hardware missing"](#) on page 1343

See Also • ["Introduction to :SBUS<n> Commands"](#) on page 755

• [":SBUS<n>:UART Commands"](#) on page 946

:SBUS<n>:UART:BAUDrate

N (see [page 1384](#))

Command Syntax :SBUS<n>:UART:BAUDrate <baudrate>

<baudrate> ::= integer from 100 to 8000000

The :SBUS<n>:UART:BAUDrate command selects the bit rate (in bps) for the serial decoder and/or trigger when in UART mode. The baud rate can be set from 100 b/s to 8 Mb/s.

If the baud rate you select does not match the system baud rate, false triggers may occur.

Query Syntax :SBUS<n>:UART:BAUDrate?

The :SBUS<n>:UART:BAUDrate? query returns the current UART baud rate setting.

Return Format <baudrate><NL>

<baudrate> ::= integer from 100 to 8000000

- See Also**
- ["Introduction to :TRIGger Commands"](#) on page 1097
 - [":TRIGger:MODE"](#) on page 1106
 - [":SBUS<n>:UART:TRIGger:TYPE"](#) on page 966

:SBUS<n>:UART:BITOrder

N (see [page 1384](#))

Command Syntax :SBUS<n>:UART:BITOrder <bitorder>

<bitorder> ::= {LSBFirst | MSBFirst}

The :SBUS<n>:UART:BITOrder command specifies the order of transmission used by the physical Tx and Rx input signals for the serial decoder and/or trigger when in UART mode. LSBFirst sets the least significant bit of each message "byte" as transmitted first. MSBFirst sets the most significant bit as transmitted first.

Query Syntax :SBUS<n>:UART:BITOrder?

The :SBUS<n>:UART:BITOrder? query returns the current UART bit order setting.

Return Format <bitorder><NL>

<bitorder> ::= {LSBF | MSBF}

- See Also**
- ["Introduction to :TRIGger Commands"](#) on page 1097
 - [":TRIGger:MODE"](#) on page 1106
 - [":SBUS<n>:UART:TRIGger:TYPE"](#) on page 966
 - [":SBUS<n>:UART:SOURce:RX"](#) on page 959
 - [":SBUS<n>:UART:SOURce:TX"](#) on page 960

:SBUS<n>:UART:COUNT:ERRor

N (see [page 1384](#))

Query Syntax :SBUS<n>:UART:COUNT:ERRor?

Returns the UART error frame count.

Return Format <frame_count><NL>

<frame_count> ::= integer in NR1 format

Errors • ["-241, Hardware missing"](#) on page 1343

- See Also**
- [":SBUS<n>:UART:COUNT:RESet"](#) on page 953
 - ["Introduction to :SBUS<n> Commands"](#) on page 755
 - [":SBUS<n>:MODE"](#) on page 759
 - [":SBUS<n>:UART Commands"](#) on page 946

:SBUS<n>:UART:COUNT:RESet

N (see [page 1384](#))

Command Syntax :SBUS<n>:UART:COUNT:RESet

Resets the UART frame counters.

Errors · ["-241, Hardware missing"](#) on page 1343

- See Also** · [":SBUS<n>:UART:COUNT:ERRor"](#) on page 952
- [":SBUS<n>:UART:COUNT:RXFRames"](#) on page 954
 - [":SBUS<n>:UART:COUNT:TXFRames"](#) on page 955
 - ["Introduction to :SBUS<n> Commands"](#) on page 755
 - [":SBUS<n>:MODE"](#) on page 759
 - [":SBUS<n>:UART Commands"](#) on page 946

:SBUS<n>:UART:COUNT:RXFRames

N (see [page 1384](#))

Query Syntax :SBUS<n>:UART:COUNT:RXFRames?

Returns the UART Rx frame count.

Return Format <frame_count><NL>

<frame_count> ::= integer in NR1 format

Errors • ["-241, Hardware missing"](#) on page 1343

- See Also**
- [":SBUS<n>:UART:COUNT:RESet"](#) on page 953
 - ["Introduction to :SBUS<n> Commands"](#) on page 755
 - [":SBUS<n>:MODE"](#) on page 759
 - [":SBUS<n>:UART Commands"](#) on page 946

:SBUS<n>:UART:COUNT:TXFRames

N (see [page 1384](#))

Query Syntax :SBUS<n>:UART:COUNT:TXFRames?

Returns the UART Tx frame count.

Return Format <frame_count><NL>

<frame_count> ::= integer in NR1 format

Errors • ["-241, Hardware missing"](#) on page 1343

- See Also**
- [":SBUS<n>:UART:COUNT:RESet"](#) on page 953
 - ["Introduction to :SBUS<n> Commands"](#) on page 755
 - [":SBUS<n>:MODE"](#) on page 759
 - [":SBUS<n>:UART Commands"](#) on page 946

:SBUS<n>:UART:FRAMing

N (see [page 1384](#))

Command Syntax :SBUS<n>:UART:FRAMing <value>

<value> ::= {OFF | <decimal> | <nondecimal>}

<decimal> ::= 8-bit integer in decimal from 0-255 (0x00-0xff)

<nondecimal> ::= #Hnn where n ::= {0,...,9 | A,...,F} for hexadecimal

<nondecimal> ::= #Bnn...n where n ::= {0 | 1} for binary

The :SBUS<n>:UART:FRAMing command determines the byte value to use for framing (end of packet) or to turn off framing for UART decode.

Query Syntax :SBUS<n>:UART:FRAMing?

The :SBUS<n>:UART:FRAMing? query returns the current UART decode base setting.

Return Format <value><NL>

<value> ::= {OFF | <decimal>}

<decimal> ::= 8-bit integer in decimal from 0-255

Errors • ["-241, Hardware missing"](#) on page 1343

See Also • ["Introduction to :SBUS<n> Commands"](#) on page 755

• [":SBUS<n>:UART Commands"](#) on page 946

:SBUS<n>:UART:PARity

N (see [page 1384](#))

Command Syntax :SBUS<n>:UART:PARity <parity>

<parity> ::= {EVEN | ODD | NONE}

The :SBUS<n>:UART:PARity command selects the parity to be used with each message "byte" for the serial decoder and/or trigger when in UART mode.

Query Syntax :SBUS<n>:UART:PARity?

The :SBUS<n>:UART:PARity? query returns the current UART parity setting.

Return Format <parity><NL>

<parity> ::= {EVEN | ODD | NONE}

- See Also**
- ["Introduction to :TRIGger Commands"](#) on page 1097
 - [":TRIGger:MODE"](#) on page 1106
 - [":SBUS<n>:UART:TRIGger:TYPE"](#) on page 966

:SBUS<n>:UART:POLarity

N (see [page 1384](#))

Command Syntax :SBUS<n>:UART:POLarity <polarity>
<polarity> ::= {HIGH | LOW}

The :SBUS<n>:UART:POLarity command selects the polarity as idle low or idle high for the serial decoder and/or trigger when in UART mode.

Query Syntax :SBUS<n>:UART:POLarity?

The :SBUS<n>:UART:POLarity? query returns the current UART polarity setting.

Return Format <polarity><NL>
<polarity> ::= {HIGH | LOW}

- See Also**
- ["Introduction to :TRIGger Commands"](#) on page 1097
 - [":TRIGger:MODE"](#) on page 1106
 - [":SBUS<n>:UART:TRIGger:TYPE"](#) on page 966

:SBUS<n>:UART:SOURce:RX

N (see [page 1384](#))

Command Syntax :SBUS<n>:UART:SOURce:RX <source>

<source> ::= {CHANnel<n> | EXTernal} for the DSO models

<source> ::= {CHANnel<n> | DIGital<d>} for the MSO models

<n> ::= 1 to (# analog channels) in NR1 format

<d> ::= 0 to (# digital channels - 1) in NR1 format

The :SBUS<n>:UART:SOURce:RX command controls which signal is used as the Rx source by the serial decoder and/or trigger when in UART mode.

Query Syntax :SBUS<n>:UART:SOURce:RX?

The :SBUS<n>:UART:SOURce:RX? query returns the current source for the UART Rx signal.

Return Format <source><NL>

- See Also**
- ["Introduction to :TRIGger Commands"](#) on page 1097
 - [":TRIGger:MODE"](#) on page 1106
 - [":SBUS<n>:UART:TRIGger:TYPE"](#) on page 966
 - [":SBUS<n>:UART:BITOrder"](#) on page 951

:SBUS<n>:UART:SOURce:TX

N (see [page 1384](#))

Command Syntax :SBUS<n>:UART:SOURce:TX <source>

<source> ::= {CHANnel<n> | EXTernal} for the DSO models

<source> ::= {CHANnel<n> | DIGital<d>} for the MSO models

<n> ::= 1 to (# analog channels) in NR1 format

<d> ::= 0 to (# digital channels - 1) in NR1 format

The :SBUS<n>:UART:SOURce:TX command controls which signal is used as the Tx source by the serial decoder and/or trigger when in UART mode.

Query Syntax :SBUS<n>:UART:SOURce:TX?

The :SBUS<n>:UART:SOURce:TX? query returns the current source for the UART Tx signal.

Return Format <source><NL>

- See Also**
- ["Introduction to :TRIGger Commands"](#) on page 1097
 - [":TRIGger:MODE"](#) on page 1106
 - [":SBUS<n>:UART:TRIGger:TYPE"](#) on page 966
 - [":SBUS<n>:UART:BITOrder"](#) on page 951

:SBUS<n>:UART:TRIGger:BASE

N (see [page 1384](#))

Command Syntax :SBUS<n>:UART:TRIGger:BASE <base>

<base> ::= {ASCIi | HEX}

The :SBUS<n>:UART:TRIGger:BASE command sets the front panel UART/RS232 trigger setup data selection option:

- ASCII – front panel data selection is from ASCII values.
- HEX – front panel data selection is from hexadecimal values.

The :SBUS<n>:UART:TRIGger:BASE setting does not affect the :SBUS<n>:UART:TRIGger:DATA command which can always set data values using ASCII or hexadecimal values.

NOTE

The :SBUS<n>:UART:TRIGger:BASE command is independent of the :SBUS<n>:UART:BASE command which affects decode and Lister only.

Query Syntax :SBUS<n>:UART:TRIGger:BASE?

The :SBUS<n>:UART:TRIGger:BASE? query returns the current UART base setting.

Return Format <base><NL>

<base> ::= {ASC | HEX}

- See Also**
- ["Introduction to :TRIGger Commands"](#) on page 1097
 - [":TRIGger:MODE"](#) on page 1106
 - [":SBUS<n>:UART:TRIGger:DATA"](#) on page 963

:SBUS<n>:UART:TRIGger:BURSt

N (see [page 1384](#))

Command Syntax :SBUS<n>:UART:TRIGger:BURSt <value>

<value> ::= {OFF | 1 to 4096 in NR1 format}

The :SBUS<n>:UART:TRIGger:BURSt command selects the burst value (Nth frame after idle period) in the range 1 to 4096 or OFF, for the trigger when in UART mode.

Query Syntax :SBUS<n>:UART:TRIGger:BURSt?

The :SBUS<n>:UART:TRIGger:BURSt? query returns the current UART trigger burst value.

Return Format <value><NL>

<value> ::= {OFF | 1 to 4096 in NR1 format}

- See Also**
- ["Introduction to :TRIGger Commands"](#) on page 1097
 - [":TRIGger:MODE"](#) on page 1106
 - [":SBUS<n>:UART:TRIGger:IDLE"](#) on page 964
 - [":SBUS<n>:UART:TRIGger:TYPE"](#) on page 966

:SBUS<n>:UART:TRIGger:DATA

N (see [page 1384](#))

Command Syntax :SBUS<n>:UART:TRIGger:DATA <value>

<value> ::= 8-bit integer from 0-255 (0x00-0xff) in decimal,
 <hexadecimal>, <binary>, or <quoted_string> format

<hexadecimal> ::= #Hnn where n ::= {0,...,9 | A,...,F} for hexadecimal

<binary> ::= #Bnn...n where n ::= {0 | 1} for binary

<quoted_string> ::= any of the 128 valid 7-bit ASCII characters
 (or standard abbreviations)

The :SBUS<n>:UART:TRIGger:DATA command selects the data byte value (0x00 to 0xFF) for the trigger QUALifier when in UART mode. The data value is used when one of the RD or TD trigger types is selected.

When entering an ASCII character via the quoted string, it must be one of the 128 valid characters (case-sensitive): "NUL", "SOH", "STX", "ETX", "EOT", "ENQ", "ACK", "BEL", "BS", "HT", "LF", "VT", "FF", "CR", "SO", "SI", "DLE", "DC1", "DC2", "DC3", "DC4", "NAK", "SYN", "ETB", "CAN", "EM", "SUB", "ESC", "FS", "GS", "RS", "US", "SP", "!", "\", "#", "\$", "%", "&", "\", "(", ")", "*", "+", ",", "-", ".", "/", "0", "1", "2", "3", "4", "5", "6", "7", "8", "9", ":", ";", "<", "=", ">", "?", "@", "A", "B", "C", "D", "E", "F", "G", "H", "I", "J", "K", "L", "M", "N", "O", "P", "Q", "R", "S", "T", "U", "V", "W", "X", "Y", "Z", "[", "\\", "]", "^", "_", "`", "a", "b", "c", "d", "e", "f", "g", "h", "i", "j", "k", "l", "m", "n", "o", "p", "q", "r", "s", "t", "u", "v", "w", "x", "y", "z", "{", "|", "}", "~", or "DEL".

Query Syntax :SBUS<n>:UART:TRIGger:DATA?

The :SBUS<n>:UART:TRIGger:DATA? query returns the current UART trigger data value.

Return Format <value><NL>

<value> ::= 8-bit integer in decimal from 0-255

- See Also**
- ["Introduction to :TRIGger Commands"](#) on page 1097
 - [":TRIGger:MODE"](#) on page 1106
 - [":SBUS<n>:UART:TRIGger:BASE"](#) on page 961
 - [":SBUS<n>:UART:TRIGger:TYPE"](#) on page 966

:SBUS<n>:UART:TRIGger:IDLE

N (see [page 1384](#))

Command Syntax :SBUS<n>:UART:TRIGger:IDLE <time_value>

<time_value> ::= time from 1 us to 10 s in NR3 format

The :SBUS<n>:UART:TRIGger:IDLE command selects the value of the idle period for burst trigger in the range from 1 us to 10 s when in UART mode.

Query Syntax :SBUS<n>:UART:TRIGger:IDLE?

The :SBUS<n>:UART:TRIGger:IDLE? query returns the current UART trigger idle period time.

Return Format <time_value><NL>

<time_value> ::= time from 1 us to 10 s in NR3 format

- See Also**
- ["Introduction to :TRIGger Commands"](#) on page 1097
 - [":TRIGger:MODE"](#) on page 1106
 - [":SBUS<n>:UART:TRIGger:BURSt"](#) on page 962
 - [":SBUS<n>:UART:TRIGger:TYPE"](#) on page 966

:SBUS<n>:UART:TRIGger:QUALifier

N (see [page 1384](#))

Command Syntax :SBUS<n>:UART:TRIGger:QUALifier <value>

<value> ::= {EQUAL | NOTequal | GREATERthan | LESSthan}

The :SBUS<n>:UART:TRIGger:QUALifier command selects the data qualifier when :TYPE is set to RDATA, RD1, RD0, RDX, TDATA, TD1, TD0, or TDX for the trigger when in UART mode.

Query Syntax :SBUS<n>:UART:TRIGger:QUALifier?

The :SBUS<n>:UART:TRIGger:QUALifier? query returns the current UART trigger qualifier.

Return Format <value><NL>

<value> ::= {EQU | NOT | GRE | LESS}

- See Also**
- ["Introduction to :TRIGger Commands"](#) on page 1097
 - [":TRIGger:MODE"](#) on page 1106
 - [":SBUS<n>:UART:TRIGger:TYPE"](#) on page 966

:SBUS<n>:UART:TRIGger:TYPE

N (see [page 1384](#))

Command Syntax :SBUS<n>:UART:TRIGger:TYPE <value>

```
<value> ::= {RStArt | RStOp | RDATA | RD1 | RD0 | RDX | PARityerror
             | TStArt | TStOp | TDATA | TD1 | TD0 | TDX}
```

The :SBUS<n>:UART:TRIGger:TYPE command selects the UART trigger type.

When one of the RD or TD types is selected, the :SBUS<n>:UART:TRIGger:DATA and :SBUS<n>:UART:TRIGger:QUALifier commands are used to specify the data value and comparison operator.

The RD1, RD0, RDX, TD1, TD0, and TDX types (for triggering on data and alert bit values) are only valid when a 9-bit width has been selected.

Query Syntax :SBUS<n>:UART:TRIGger:TYPE?

The :SBUS<n>:UART:TRIGger:TYPE? query returns the current UART trigger data value.

Return Format <value><NL>

```
<value> ::= {RSTA | RSTO | RDAT | RD1 | RD0 | RDX | PAR | TSTA |
             TSTO | TDAT | TD1 | TD0 | TDX}
```

- See Also**
- ["Introduction to :TRIGger Commands"](#) on page 1097
 - [":TRIGger:MODE"](#) on page 1106
 - [":SBUS<n>:UART:TRIGger:DATA"](#) on page 963
 - [":SBUS<n>:UART:TRIGger:QUALifier"](#) on page 965
 - [":SBUS<n>:UART:WIDTH"](#) on page 967

:SBUS<n>:UART:WIDTh

N (see [page 1384](#))

Command Syntax :SBUS<n>:UART:WIDTh <width>

<width> ::= {5 | 6 | 7 | 8 | 9}

The :SBUS<n>:UART:WIDTh command determines the number of bits (5-9) for each message "byte" for the serial decoder and/or trigger when in UART mode.

Query Syntax :SBUS<n>:UART:WIDTh?

The :SBUS<n>:UART:WIDTh? query returns the current UART width setting.

Return Format <width><NL>

<width> ::= {5 | 6 | 7 | 8 | 9}

- See Also**
- ["Introduction to :TRIGger Commands"](#) on page 1097
 - [":TRIGger:MODE"](#) on page 1106
 - [":SBUS<n>:UART:TRIGger:TYPE"](#) on page 966

30 :SEARCh Commands

Control the event search modes and parameters for each search type. See:

- **":SEARCh:General Commands"** on page 970
- **":SEARCh:EDGE Commands"** on page 975
- **":SEARCh:GLITCh Commands"** on page 978 (Pulse Width search)
- **":SEARCh:PEAK Commands"** on page 985
- **":SEARCh:RUNT Commands"** on page 990
- **":SEARCh:TRANSition Commands"** on page 995
- **":SEARCh:SERial:A429 Commands"** on page 1000
- **":SEARCh:SERial:CAN Commands"** on page 1006
- **":SEARCh:SERial:FLEXray Commands"** on page 1016
- **":SEARCh:SERial:I2S Commands"** on page 1022
- **":SEARCh:SERial:IIC Commands"** on page 1028
- **":SEARCh:SERial:LIN Commands"** on page 1035
- **":SEARCh:SERial:M1553 Commands"** on page 1044
- **":SEARCh:SERial:SENT Commands"** on page 1048
- **":SEARCh:SERial:SPI Commands"** on page 1053
- **":SEARCh:SERial:UART Commands"** on page 1057

General :SEARCH Commands

Table 123 General :SEARCH Commands Summary

Command	Query	Options and Query Returns
n/a	:SEARCH:COUNT? (see page 971)	<count> ::= an integer count value
:SEARCH:EVENT <event_number> (see page 972)	:SEARCH:EVENT? (see page 972)	<event_number> ::= the integer number of a found search event
:SEARCH:MODE <value> (see page 973)	:SEARCH:MODE? (see page 973)	<value> ::= {EDGE GLITCh RUNT TRANSition SERIAL{1 2} PEAK}
:SEARCH:STATE <value> (see page 974)	:SEARCH:STATE? (see page 974)	<value> ::= {{0 OFF} {1 ON}}

:SEARCh:COUNT

N (see [page 1384](#))

Query Syntax :SEARCh:COUNT?

The :SEARCh:COUNT? query returns the number of search events found.

Return Format <count><NL>

<count> ::= an integer count value

- See Also**
- [Chapter 30](#), “:SEARCh Commands,” starting on page 969
 - [":SEARCh:EVENT"](#) on page 972
 - [":SEARCh:STATe"](#) on page 974
 - [":SEARCh:MODE"](#) on page 973

:SEARCh:EVENT

N (see [page 1384](#))

Command Syntax :SEARCh:EVENT <event_number>

<event_number> ::= the integer number of a found search event

The :SEARCh:EVENT command navigates to a found search event.

If the :SEARCh:STATe is ON, the horizontal position is changed so that the specified event is located at the time reference.

Query Syntax :SEARCh:EVENT?

The :SEARCh:EVENT? query returns the currently selected event number.

Return Format <event_number><NL>

<event_number> ::= the integer number of a found search event

- See Also**
- [Chapter 30](#), “:SEARCh Commands,” starting on page 969
 - [":SEARCh:COUNt"](#) on page 971
 - [":SEARCh:STATe"](#) on page 974
 - [":SEARCh:MODE"](#) on page 973

:SEARCh:MODE

N (see [page 1384](#))

Command Syntax :SEARCh:MODE <value>

<value> ::= {EDGE | GLITCh | RUNT | TRANsition | SERial{1 | 2} | PEAK}

The :SEARCh:MODE command selects the search mode.

The command is only valid when the :SEARCh:STATe is ON.

Query Syntax :SEARCh:MODE?

The :SEARCh:MODE? query returns the currently selected mode or OFF if the :SEARCh:STATe is OFF.

Return Format <value><NL>

<value> ::= {EDGE | GLIT | RUNT | TRAN | SER{1 | 2} | PEAK | OFF}

- See Also**
- [Chapter 30](#), “:SEARCh Commands,” starting on page 969
 - [":SEARCh:STATe"](#) on page 974
 - [":SEARCh:COUNt"](#) on page 971
 - [":SEARCh:EVENT"](#) on page 972

:SEARCh:STATe

N (see [page 1384](#))

Command Syntax :SEARCh:STATe <value>

<value> ::= {{0 | OFF} | {1 | ON}}

The :SEARCh:STATe command enables or disables the search feature.

Query Syntax :SEARCh:STATe?

The :SEARCh:STATe? query returns returns the current setting.

Return Format <value><NL>

<value> ::= {0 | 1}

- See Also**
- [Chapter 30](#), “:SEARCh Commands,” starting on page 969
 - [":SEARCh:MODE"](#) on page 973
 - [":SEARCh:COUNt"](#) on page 971
 - [":SEARCh:EVENT"](#) on page 972

:SEARCh:EDGE Commands

Table 124:SEARCh:EDGE Commands Summary

Command	Query	Options and Query Returns
:SEARCh:EDGE:SLOPe <slope> (see page 976)	:SEARCh:EDGE:SLOPe? (see page 976)	<slope> ::= {POSitive NEGative EITHer}
:SEARCh:EDGE:SOURce <source> (see page 977)	:SEARCh:EDGE:SOURce? (see page 977)	<source> ::= CHANnel<n> <n> ::= 1 to (# analog channels) in NR1 format

:SEARCh:EDGE:SLOPe

N (see [page 1384](#))

Command Syntax :SEARCh:EDGE:SLOPe <slope>

<slope> ::= {NEGative | POSitive | EITHer}

The :SEARCh:EDGE:SLOPe command specifies the slope of the edge for the search.

Query Syntax :SEARCh:EDGE:SLOPe?

The :SEARCh:EDGE:SLOPe? query returns the current slope setting.

Return Format <slope><NL>

<slope> ::= {NEG | POS | EITH}

See Also • [Chapter 30](#), “:SEARCh Commands,” starting on page 969

:SEARCh:EDGE:SOURce

N (see [page 1384](#))

Command Syntax :SEARCh:EDGE:SOURce <source>

<source> ::= CHANnel<n>

<n> ::= 1 to (# analog channels) in NR1 format

The :SEARCh:EDGE:SOURce command selects the channel on which to search for edges.

Query Syntax :SEARCh:EDGE:SOURce?

The :SEARCh:EDGE:SOURce? query returns the current source.

Return Format <source><NL>

<source> ::= CHAN<n>

See Also • [Chapter 30](#), “:SEARCh Commands,” starting on page 969

:SEARCH:GLITCh Commands

Table 125: :SEARCH:GLITCh Commands Summary

Command	Query	Options and Query Returns
:SEARCH:GLITCh:GREate rthan <greater_than_time>[s uffix] (see page 979)	:SEARCH:GLITCh:GREate rthan? (see page 979)	<greater_than_time> ::= floating-point number in NR3 format [suffix] ::= {s ms us ns ps}
:SEARCH:GLITCh:LESSt han <less_than_time>[suff ix] (see page 980)	:SEARCH:GLITCh:LESSt han? (see page 980)	<less_than_time> ::= floating-point number in NR3 format [suffix] ::= {s ms us ns ps}
:SEARCH:GLITCh:POLari ty <polarity> (see page 981)	:SEARCH:GLITCh:POLari ty? (see page 981)	<polarity> ::= {POSitive NEGative}
:SEARCH:GLITCh:QUALif ier <qualifier> (see page 982)	:SEARCH:GLITCh:QUALif ier? (see page 982)	<qualifier> ::= {GREaterthan LESSthan RANGE}
:SEARCH:GLITCh:RANGE <less_than_time>[suff ix], <greater_than_time>[s uffix] (see page 983)	:SEARCH:GLITCh:RANGE? (see page 983)	<less_than_time> ::= 15 ns to 10 seconds in NR3 format <greater_than_time> ::= 10 ns to 9.99 seconds in NR3 format [suffix] ::= {s ms us ns ps}
:SEARCH:GLITCh:SOURce <source> (see page 984)	:SEARCH:GLITCh:SOURce ? (see page 984)	<source> ::= CHANnel<n> <n> ::= 1 to (# analog channels) in NR1 format

:SEARCh:GLITCh:GREaterthan

N (see [page 1384](#))

Command Syntax :SEARCh:GLITCh:GREaterthan <greater_than_time>[<suffix>]

<greater_than_time> ::= floating-point number in NR3 format

<suffix> ::= {s | ms | us | ns | ps}

The :SEARCh:GLITCh:GREaterthan command sets the minimum pulse width duration for the selected :SEARCh:GLITCh:SOURce.

Query Syntax :SEARCh:GLITCh:GREaterthan?

The :SEARCh:GLITCh:GREaterthan? query returns the minimum pulse width duration time for :SEARCh:GLITCh:SOURce.

Return Format <greater_than_time><NL>

<greater_than_time> ::= floating-point number in NR3 format.

- See Also**
- [Chapter 30](#), “:SEARCh Commands,” starting on page 969
 - [":SEARCh:GLITCh:SOURce"](#) on page 984
 - [":SEARCh:GLITCh:QUALifier"](#) on page 982
 - [":SEARCh:MODE"](#) on page 973

:SEARCh:GLITCh:LESSthan

N (see [page 1384](#))

Command Syntax :SEARCh:GLITCh:LESSthan <less_than_time> [<suffix>]
 <less_than_time> ::= floating-point number in NR3 format
 <suffix> ::= {s | ms | us | ns | ps}

The :SEARCh:GLITCh:LESSthan command sets the maximum pulse width duration for the selected :SEARCh:GLITCh:SOURce.

Query Syntax :SEARCh:GLITCh:LESSthan?

The :SEARCh:GLITCh:LESSthan? query returns the pulse width duration time for :SEARCh:GLITCh:SOURce.

Return Format <less_than_time><NL>
 <less_than_time> ::= floating-point number in NR3 format.

- See Also**
- [Chapter 30](#), “:SEARCh Commands,” starting on page 969
 - [":SEARCh:GLITCh:SOURce"](#) on page 984
 - [":SEARCh:GLITCh:QUALifier"](#) on page 982
 - [":SEARCh:MODE"](#) on page 973

:SEARCh:GLITCh:POLarity

N (see [page 1384](#))

Command Syntax :SEARCh:GLITCh:POLarity <polarity>
 <polarity> ::= {POSitive | NEGative}

The :SEARCh:GLITCh:POLarity command sets the polarity for the glitch (pulse width) search.

Query Syntax :SEARCh:GLITCh:POLarity?

The :SEARCh:GLITCh:POLarity? query returns the current polarity setting for the glitch (pulse width) search.

Return Format <polarity><NL>
 <polarity> ::= {POS | NEG}

- See Also**
- [Chapter 30](#), “:SEARCh Commands,” starting on page 969
 - [":SEARCh:MODE"](#) on page 973
 - [":SEARCh:GLITCh:SOURce"](#) on page 984

:SEARCh:GLITCh:QUALifier

N (see [page 1384](#))

Command Syntax :SEARCh:GLITCh:QUALifier <operator>

<operator> ::= {GREATERthan | LESSthan | RANGE}

This command sets the mode of operation of the glitch (pulse width) search. The oscilloscope can search for a pulse width that is greater than a time value, less than a time value, or within a range of time values.

Query Syntax :SEARCh:GLITCh:QUALifier?

The :SEARCh:GLITCh:QUALifier? query returns the glitch (pulse width) qualifier.

Return Format <operator><NL>

<operator> ::= {GRE | LESS | RANG}

- See Also**
- [Chapter 30](#), “:SEARCh Commands,” starting on page 969
 - [":SEARCh:GLITCh:SOURce"](#) on page 984
 - [":SEARCh:MODE"](#) on page 973

:SEARCh:GLITCh:RANGe

N (see [page 1384](#))

Command Syntax :SEARCh:GLITCh:RANGe <less_than_time>[suffix],
<greater_than_time>[suffix]

<less_than_time> ::= (15 ns - 10 seconds) in NR3 format

<greater_than_time> ::= (10 ns - 9.99 seconds) in NR3 format

[suffix] ::= {s | ms | us | ns | ps}

The :SEARCh:GLITCh:RANGe command sets the pulse width duration for the selected :SEARCh:GLITCh:SOURce. You can enter the parameters in any order – the smaller value becomes the <greater_than_time> and the larger value becomes the <less_than_time>.

Query Syntax :SEARCh:GLITCh:RANGe?

The :SEARCh:GLITCh:RANGe? query returns the pulse width duration time for :SEARCh:GLITCh:SOURce.

Return Format <less_than_time>,<greater_than_time><NL>

- See Also**
- [Chapter 30](#), “:SEARCh Commands,” starting on page 969
 - “:SEARCh:GLITCh:SOURce” on page 984
 - “:SEARCh:GLITCh:QUALifier” on page 982
 - “:SEARCh:MODE” on page 973

:SEARCH:GLITCH:SOURCE

N (see [page 1384](#))

Command Syntax :SEARCH:GLITCH:SOURCE <source>

<source> ::= CHANNEL<n>

<n> ::= 1 to (# analog channels) in NR1 format

The :SEARCH:GLITCH:SOURCE command selects the channel on which to search for glitches (pulse widths).

Query Syntax :SEARCH:GLITCH:SOURCE?

The :SEARCH:GLITCH:SOURCE? query returns the current pulse width source.

If all channels are off, the query returns "NONE."

Return Format <source><NL>

- See Also**
- [Chapter 30](#), “:SEARCH Commands,” starting on page 969
 - [Chapter 30](#), “:SEARCH Commands,” starting on page 969
 - [":SEARCH:MODE"](#) on page 973
 - [":SEARCH:GLITCH:POLARITY"](#) on page 981
 - [":SEARCH:GLITCH:QUALIFIER"](#) on page 982
 - [":SEARCH:GLITCH:RANGE"](#) on page 983

:SEARCh:PEAK Commands

Table 126:SEARCh:PEAK Commands Summary

Command	Query	Options and Query Returns
:SEARCh:PEAK:EXCursio n <delta_level> (see page 986)	:SEARCh:PEAK:EXCursio n? (see page 986)	<delta_level> ::= required change in level to be recognized as a peak, in NR3 format.
:SEARCh:PEAK:NPEaks <number> (see page 987)	:SEARCh:PEAK:NPEaks? (see page 987)	<number> ::= max number of peaks to find, 1-11 in NR1 format.
:SEARCh:PEAK:SOURce <source> (see page 988)	:SEARCh:PEAK:SOURce? (see page 988)	<source> ::= {FUNCTION<m> MATH<m> FFT} (must be an FFT waveform) <m> ::= 1 to (# math functions) in NR1 format
:SEARCh:PEAK:THReshol d <level> (see page 989)	:SEARCh:PEAK:THReshol d? (see page 989)	<level> ::= necessary level to be considered a peak, in NR3 format.

:SEARCh:PEAK:EXCursion

N (see [page 1384](#))

Command Syntax :SEARCh:PEAK:EXCursion <delta_level>

<delta_level> ::= required change in level to be recognized as a peak, in NR3 format.

The :SEARCh:PEAK:EXCursion command specifies the change in level that must occur (in other words, hysteresis) to be recognized as a peak.

The threshold level units are specified by the :FFT:VTYPE or :FUNCTION<m>[:FFT]:VTYPE command.

Query Syntax :SEARCh:PEAK:EXCursion?

The :SEARCh:PEAK:EXCursion? query returns the specified excursion delta level value.

Return Format <delta_level><NL>

<delta_level> ::= in NR3 format.

- See Also**
- [":FFT:VTYPE"](#) on page 388
 - [":FUNCTION<m>\[:FFT\]:VTYPE"](#) on page 410
 - [":SEARCh:PEAK:NPEaks"](#) on page 987
 - [":SEARCh:PEAK:SOURce"](#) on page 988
 - [":SEARCh:PEAK:THReshold"](#) on page 989

:SEARCh:PEAK:NPEaks

N (see [page 1384](#))

Command Syntax :SEARCh:PEAK:NPEaks <number>

<number> ::= max number of peaks to find, 1-11 in NR1 format.

The :SEARCh:PEAK:NPEaks command specifies the maximum number of FFT peaks to find. This number can be from 1 to 11.

Query Syntax :SEARCh:PEAK:NPEaks?

The :SEARCh:PEAK:NPEaks? query returns the specified maximum number of FFT peaks to find.

Return Format <number><NL>

<number> ::= in NR1 format.

- See Also**
- [":SEARCh:PEAK:EXCursion"](#) on page 986
 - [":SEARCh:PEAK:SOURce"](#) on page 988
 - [":SEARCh:PEAK:THReshold"](#) on page 989

:SEARCh:PEAK:SOURce

N (see [page 1384](#))

Command Syntax :SEARCh:PEAK:SOURce <source>

<source> ::= {FUNCTION<m> | MATH<m> | FFT} (source must be an FFT waveform)

<m> ::= 1 to (# math functions) in NR1 format

The :SEARCh:PEAK:SOURce command selects the FFT math function waveform to search.

Query Syntax :SEARCh:PEAK:SOURce?

The :SEARCh:PEAK:SOURce? query returns the FFT math function waveform that is being searched.

Return Format <source><NL>

<source> ::= {FUNC<m> | FFT} (must be FFT)

<m> ::= 1 to (# math functions) in NR1 format

- See Also**
- [":SEARCh:PEAK:EXCursion"](#) on page 986
 - [":SEARCh:PEAK:NPEaks"](#) on page 987
 - [":SEARCh:PEAK:THReshold"](#) on page 989

:SEARCh:PEAK:THReshold

N (see [page 1384](#))

Command Syntax :SEARCh:PEAK:THReshold <level>

<level> ::= necessary level to be considered a peak, in NR3 format.

The :SEARCh:PEAK:THReshold command specifies the threshold level necessary to be considered a peak.

The threshold level units are specified by the :FFT:VTYPE or :FUNCTion<m>[:FFT]:VTYPE command.

Query Syntax :SEARCh:PEAK:THReshold?

The :SEARCh:PEAK:THReshold? query returns the specified threshold level for FFT peak search.

Return Format <level><NL>

<level> ::= in NR3 format.

- See Also**
- [":FFT:VTYPE"](#) on page 388
 - [":FUNCTion<m>\[:FFT\]:VTYPE"](#) on page 410
 - [":SEARCh:PEAK:EXCURSION"](#) on page 986
 - [":SEARCh:PEAK:NPEAKS"](#) on page 987
 - [":SEARCh:PEAK:SOURCE"](#) on page 988

:SEARCH:RUNT Commands

Table 127 :SEARCH:RUNT Commands Summary

Command	Query	Options and Query Returns
:SEARCH:RUNT:POLarity <polarity> (see page 991)	:SEARCH:RUNT:POLarity ? (see page 991)	<polarity> ::= {POSitive NEGative EITHer}
:SEARCH:RUNT:QUALifier <qualifier> (see page 992)	:SEARCH:RUNT:QUALifier? (see page 992)	<qualifier> ::= {GREaterthan LESSthan NONE}
:SEARCH:RUNT:SOURce <source> (see page 993)	:SEARCH:RUNT:SOURce? (see page 993)	<source> ::= CHANnel<n> <n> ::= 1 to (# analog channels) in NR1 format
:SEARCH:RUNT:TIME <time>[suffix] (see page 994)	:SEARCH:RUNT:TIME? (see page 994)	<time> ::= floating-point number in NR3 format [suffix] ::= {s ms us ns ps}

:SEARCh:RUNT:POLarity

N (see [page 1384](#))

Command Syntax :SEARCh:RUNT:POLarity <slope>

<polarity> ::= {POSitive | NEGative | EITHer}

The :SEARCh:RUNT:POLarity command sets the polarity for the runt search.

Query Syntax :SEARCh:RUNT:POLarity?

The :SEARCh:RUNT:POLarity? query returns the currently set runt polarity.

Return Format <slope><NL>

<polarity> ::= {POS | NEG | EITH}

- See Also**
- [Chapter 30](#), “:SEARCh Commands,” starting on page 969
 - [":SEARCh:MODE"](#) on page 973
 - [":SEARCh:RUNT:SOURce"](#) on page 993

:SEARCh:RUNT:QUALifier

N (see [page 1384](#))

Command Syntax :SEARCh:RUNT:QUALifier <qualifier>

<qualifier> ::= {GREATERthan | LESSthan | NONE}

The :SEARCh:RUNT:QUALifier command specifies whether to search for a runt that is greater than a time value, less than a time value, or any time value.

Query Syntax :SEARCh:RUNT:QUALifier?

The :SEARCh:RUNT:QUALifier? query returns the current runt search qualifier.

Return Format <qualifier><NL>

<qualifier> ::= {GRE | LESS NONE}

- See Also**
- [Chapter 30](#), “:SEARCh Commands,” starting on page 969
 - [":SEARCh:MODE"](#) on page 973

:SEARCh:RUNT:SOURce

N (see [page 1384](#))

Command Syntax :SEARCh:RUNT:SOURce <source>

<source> ::= CHANnel<n>

<n> ::= 1 to (# analog channels) in NR1 format

The :SEARCh:RUNT:SOURce command selects the channel on which to search for the runt pulse.

Query Syntax :SEARCh:RUNT:SOURce?

The :SEARCh:RUNT:SOURce? query returns the current runt search source.

Return Format <source><NL>

<source> ::= CHAN<n>

- See Also**
- [Chapter 30](#), “:SEARCh Commands,” starting on page 969
 - [":SEARCh:RUNT:POLarity"](#) on page 991

:SEARCH:RUNT:TIME

N (see [page 1384](#))

Command Syntax :SEARCH:RUNT:TIME <time>[suffix]

<time> ::= floating-point number in NR3 format

[suffix] ::= {s | ms | us | ns | ps}

When searching for runt pulses whose widths are greater than or less than a time (see :SEARCH:RUNT:QUALifier), the :SEARCH:RUNT:TIME command specifies the time value.

Query Syntax :SEARCH:RUNT:TIME?

The :SEARCH:RUNT:TIME? query returns the currently specified runt time value.

Return Format <time><NL>

<time> ::= floating-point number in NR3 format

- See Also**
- [Chapter 30](#), “:SEARCH Commands,” starting on page 969
 - [":SEARCH:RUNT:QUALifier"](#) on page 992

:SEARCh:TRANsition Commands

Table 128:SEARCh:TRANsition Commands Summary

Command	Query	Options and Query Returns
:SEARCh:TRANsition:QUAlifier <qualifier> (see page 996)	:SEARCh:TRANsition:QUAlifier? (see page 996)	<qualifier> ::= {GREATERthan LESSthan}
:SEARCh:TRANsition:SLOPe <slope> (see page 997)	:SEARCh:TRANsition:SLOPe? (see page 997)	<slope> ::= {NEGative POSitive}
:SEARCh:TRANsition:SOURce <source> (see page 998)	:SEARCh:TRANsition:SOURce? (see page 998)	<source> ::= CHANnel<n> <n> ::= 1 to (# analog channels) in NR1 format
:SEARCh:TRANsition:TIME <time>[suffix] (see page 999)	:SEARCh:TRANsition:TIME? (see page 999)	<time> ::= floating-point number in NR3 format [suffix] ::= {s ms us ns ps}

:SEARCh:TRANSition:QUALifier

N (see [page 1384](#))

Command Syntax :SEARCh:TRANSition:QUALifier <qualifier>
 <qualifier> ::= {GREATERthan | LESSthan}

The :SEARCh:TRANSition:QUALifier command specifies whether to search for edge transitions greater than or less than a time.

Query Syntax :SEARCh:TRANSition:QUALifier?

The :SEARCh:TRANSition:QUALifier? query returns the current transition search qualifier.

Return Format <qualifier><NL>
 <qualifier> ::= {GRE | LESS}

- See Also**
- [Chapter 30](#), “:SEARCh Commands,” starting on page 969
 - [":SEARCh:MODE"](#) on page 973
 - [":SEARCh:TRANSition:TIME"](#) on page 999

:SEARCh:TRANSition:SLOPe

N (see [page 1384](#))

Command Syntax :SEARCh:TRANSition:SLOPe <slope>
 <slope> ::= {NEGative | POSitive}

The :SEARCh:TRANSition:SLOPe command selects whether to search for rising edge (POSitive slope) transitions or falling edge (NEGative slope) transitions.

Query Syntax :SEARCh:TRANSition:SLOPe?

The :SEARCh:TRANSition:SLOPe? query returns the current transition search slope setting.

Return Format <slope><NL>
 <slope> ::= {NEG | POS}

- See Also**
- [Chapter 30](#), “:SEARCh Commands,” starting on page 969
 - [":SEARCh:MODE"](#) on page 973
 - [":SEARCh:TRANSition:SOURce"](#) on page 998
 - [":SEARCh:TRANSition:TIME"](#) on page 999

:SEARCh:TRANSition:SOURce

N (see [page 1384](#))

Command Syntax :SEARCh:TRANSition:SOURce <source>

<source> ::= CHANnel<n>

<n> ::= 1 to (# analog channels) in NR1 format

The :SEARCh:TRANSition:SOURce command selects the channel on which to search for edge transitions.

Query Syntax :SEARCh:TRANSition:SOURce?

The :SEARCh:TRANSition:SOURce? query returns the current transition search source.

Return Format <source><NL>

<source> ::= CHAN<n>

- See Also**
- [Chapter 30](#), “:SEARCh Commands,” starting on page 969
 - [":SEARCh:MODE"](#) on page 973
 - [":SEARCh:TRANSition:SLOPe"](#) on page 997

:SEARCh:TRANSition:TIME

N (see [page 1384](#))

Command Syntax :SEARCh:TRANSition:TIME <time>[suffix]

<time> ::= floating-point number in NR3 format

[suffix] ::= {s | ms | us | ns | ps}

The :SEARCh:TRANSition:TIME command sets the time of the transition to search for. You can search for transitions greater than or less than this time.

Query Syntax :SEARCh:TRANSition:TIME?

The :SEARCh:TRANSition:TIME? query returns the current transition time value.

Return Format <time><NL>

<time> ::= floating-point number in NR3 format

- See Also**
- [Chapter 30](#), “:SEARCh Commands,” starting on page 969
 - [":SEARCh:TRANSition:QUALifier"](#) on page 996

:SEARCH:SERIAL:A429 Commands

Table 129:SEARCH:SERIAL:A429 Commands Summary

Command	Query	Options and Query Returns
:SEARCH:SERIAL:A429:LABel <value> (see page 1001)	:SEARCH:SERIAL:A429:LABel? (see page 1001)	<value> ::= 8-bit integer in decimal, <hex>, <octal>, or <string> from 0-255 <hex> ::= #Hnn where n ::= {0,...,9 A,...,F} <octal> ::= #Qnnn where n ::= {0,...,7} <string> ::= "0xnn" where n ::= {0,...,9 A,...,F}
:SEARCH:SERIAL:A429:MODE <condition> (see page 1002)	:SEARCH:SERIAL:A429:MODE? (see page 1002)	<condition> ::= {LABEL LBITs PERRor WERRor GERRor WGERrors ALLerrors}
:SEARCH:SERIAL:A429:PATTern:DATA <string> (see page 1003)	:SEARCH:SERIAL:A429:PATTern:DATA? (see page 1003)	<string> ::= "nn...n" where n ::= {0 1}, length depends on FORMat
:SEARCH:SERIAL:A429:PATTern:SDI <string> (see page 1004)	:SEARCH:SERIAL:A429:PATTern:SDI? (see page 1004)	<string> ::= "nn" where n ::= {0 1}, length always 2 bits
:SEARCH:SERIAL:A429:PATTern:SSM <string> (see page 1005)	:SEARCH:SERIAL:A429:PATTern:SSM? (see page 1005)	<string> ::= "nn" where n ::= {0 1}, length always 2 bits

:SEARCh:SERial:A429:LABel

N (see [page 1384](#))

Command Syntax :SEARCh:SERial:A429:LABel <value>
 <value> ::= 8-bit integer in decimal, <hex>, <octal>, or <string>
 from 0-255

<hex> ::= #Hnn where n ::= {0,...,9 | A,...,F}

<octal> ::= #Qnnn where n ::= {0,...,7}

<string> ::= "0xnn" where n ::= {0,...,9 | A,...,F}

The :SEARCh:SERial:A429:LABel command defines the ARINC 429 label value when labels are used in the selected search mode.

Query Syntax :SEARCh:SERial:A429:LABel?

The :SEARCh:SERial:A429:LABel? query returns the current label value in decimal format.

Return Format <value><NL> in decimal format

Errors · ["-241, Hardware missing"](#) on page 1343

See Also · ["Introduction to :TRIGger Commands"](#) on page 1097
 · [":SEARCh:SERial:A429:MODE"](#) on page 1002

:SEARCh:SERial:A429:MODE

N (see [page 1384](#))

Command Syntax :SEARCh:SERial:A429:MODE <condition>
 <condition> ::= {LAbel | LBITs | PERRor | WERRor | GERRor | WGERrors
 | ALLerrors}

The :SEARCh:SERial:A429:MODE command selects the type of ARINC 429 information to find in the Lister display:

- LAbel – finds the specified label value.
- LBITs – finds the label and the other word fields as specified.
- PERRor – finds words with a parity error.
- WERRor – finds an intra-word coding error.
- GERRor – finds an inter-word gap error.
- WGERrors – finds either a Word or Gap Error.
- ALLerrors – finds any of the above errors.

Query Syntax :SEARCh:SERial:A429:MODE?

The :SEARCh:SERial:A429:MODE? query returns the current ARINC 429 search mode condition.

Return Format <condition><NL>
 <condition> ::= {LAB | LBIT | PERR | WERR | GERR | WGER | ALL}

Errors • ["-241, Hardware missing"](#) on page 1343

- See Also**
- ["Introduction to :SBUS<n> Commands"](#) on page 755
 - [":SBUS<n>:MODE"](#) on page 759
 - [":SEARCh:SERial:A429:LAbel"](#) on page 1001
 - [":SEARCh:SERial:A429:PATtern:DATA"](#) on page 1003
 - [":SEARCh:SERial:A429:PATtern:SDI"](#) on page 1004
 - [":SEARCh:SERial:A429:PATtern:SSM"](#) on page 1005
 - [":SBUS<n>:A429:SOURce"](#) on page 769

:SEARCh:SERial:A429:PATtern:DATA

N (see [page 1384](#))

Command Syntax :SEARCh:SERial:A429:PATtern:DATA <string>
 <string> ::= "nn...n" where n ::= {0 | 1}, length depends on FORMat

The :SEARCh:SERial:A429:PATtern:DATA command defines the ARINC 429 data pattern resource according to the string parameter. This pattern controls the data pattern searched for in each ARINC 429 word.

NOTE

If more bits are sent for <string> than specified by the :SBUS<n>:A429:FORMat command, the most significant bits will be truncated.

Query Syntax :SEARCh:SERial:A429:PATtern:DATA?

The :SEARCh:SERial:A429:PATtern:DATA? query returns the current settings of the specified ARINC 429 data pattern resource in the binary string format.

Return Format <string><NL>

Errors · ["-241, Hardware missing"](#) on page 1343

See Also · ["Introduction to :TRIGger Commands"](#) on page 1097
 · [":SEARCh:SERial:A429:MODE"](#) on page 1002
 · [":SEARCh:SERial:A429:PATtern:SDI"](#) on page 1004
 · [":SEARCh:SERial:A429:PATtern:SSM"](#) on page 1005

:SEARCH:SERIAL:A429:PATTERN:SDI

N (see [page 1384](#))

Command Syntax :SEARCH:SERIAL:A429:PATTERN:SDI <string>

<string> ::= "nn" where n ::= {0 | 1}, length always 2 bits

The :SEARCH:SERIAL:A429:PATTERN:SDI command defines the ARINC 429 two-bit SDI pattern resource according to the string parameter. This pattern controls the SDI pattern searched for in each ARINC 429 word.

The specified SDI is only used if the :SBUS<n>:A429:FORMAT includes the SDI field.

Query Syntax :SEARCH:SERIAL:A429:PATTERN:SDI?

The :SEARCH:SERIAL:A429:PATTERN:SDI? query returns the current settings of the specified ARINC 429 two-bit SDI pattern resource in the binary string format.

Return Format <string><NL>

Errors · ["-241, Hardware missing"](#) on page 1343

See Also · ["Introduction to :TRIGGER Commands"](#) on page 1097

· [":SBUS<n>:A429:FORMAT"](#) on page 767

· [":SEARCH:SERIAL:A429:MODE"](#) on page 1002

· [":SEARCH:SERIAL:A429:PATTERN:DATA"](#) on page 1003

· [":SEARCH:SERIAL:A429:PATTERN:SSM"](#) on page 1005

:SEARCh:SERial:A429:PATtern:SSM

N (see [page 1384](#))

Command Syntax :SEARCh:SERial:A429:PATtern:SSM <string>

<string> ::= "nn" where n ::= {0 | 1}, length always 2 bits

The :SEARCh:SERial:A429:PATtern:SSM command defines the ARINC 429 two-bit SSM pattern resource according to the string parameter. This pattern controls the SSM pattern searched for in each ARINC 429 word.

The specified SSM is only used if the :SBUS<n>:A429:FORMat includes the SSM field.

Query Syntax :SEARCh:SERial:A429:PATtern:SSM?

The :SEARCh:SERial:A429:PATtern:SSM? query returns the current settings of the specified ARINC 429 two-bit SSM pattern resource in the binary string format.

Return Format <string><NL>

Errors · ["-241, Hardware missing"](#) on page 1343

See Also · ["Introduction to :TRIGger Commands"](#) on page 1097

· [":SBUS<n>:A429:FORMat"](#) on page 767

· [":SEARCh:SERial:A429:MODE"](#) on page 1002

· [":SEARCh:SERial:A429:PATtern:DATA"](#) on page 1003

· [":SEARCh:SERial:A429:PATtern:SDI"](#) on page 1004

:SEARCH:SERIAL:CAN Commands

Table 130:SEARCH:SERIAL:CAN Commands Summary

Command	Query	Options and Query Returns
:SEARCH:SERIAL:CAN:MODE <value> (see page 1007)	:SEARCH:SERIAL:CAN:MODE? (see page 1007)	<value> ::= {IDData DATA IDRemote IDEither ERROR ACKError FORMError STUFFerror CRCError ALLerrors OVERload MESSAGE MSIGNAL}
:SEARCH:SERIAL:CAN:PARTern:DATA <string> (see page 1009)	:SEARCH:SERIAL:CAN:PARTern:DATA? (see page 1009)	<string> ::= "0xnn...n" where n ::= {0,...,9 A,...,F X} for hexadecimal
:SEARCH:SERIAL:CAN:PARTern:DATA:LENGTH <length> (see page 1010)	:SEARCH:SERIAL:CAN:PARTern:DATA:LENGTH? (see page 1010)	<length> ::= integer from 1 to 8 in NR1 format
:SEARCH:SERIAL:CAN:PARTern:ID <string> (see page 1011)	:SEARCH:SERIAL:CAN:PARTern:ID? (see page 1011)	<string> ::= "0xnn...n" where n ::= {0,...,9 A,...,F X} for hexadecimal
:SEARCH:SERIAL:CAN:PARTern:ID:MODE <value> (see page 1012)	:SEARCH:SERIAL:CAN:PARTern:ID:MODE? (see page 1012)	<value> ::= {STANDARD EXTENDED}
:SEARCH:SERIAL:CAN:SYMBOLic:MESSAGE <name> (see page 1013)	:SEARCH:SERIAL:CAN:SYMBOLic:MESSAGE? (see page 1013)	<name> ::= quoted ASCII string
:SEARCH:SERIAL:CAN:SYMBOLic:SIGNAL <name> (see page 1014)	:SEARCH:SERIAL:CAN:SYMBOLic:SIGNAL? (see page 1014)	<name> ::= quoted ASCII string
:SEARCH:SERIAL:CAN:SYMBOLic:VALUE <data> (see page 1015)	:SEARCH:SERIAL:CAN:SYMBOLic:VALUE? (see page 1015)	<data> ::= value in NR3 format

:SEARCH:SERIAL:CAN:MODE

N (see [page 1384](#))

Command Syntax :SEARCH:SERIAL:CAN:MODE <value>

```
<value> ::= {IDData | DATA | IDRemote | IDEither | ERRor | ACKerror
            | FORMerror | STUFFerror | CRCerror | ALLerrors | OVERload
            | MESSage | MSIGnal}
```

The :SEARCH:SERIAL:CAN:MODE command selects the type of CAN information to find in the Lister display:

Condition	Front-panel name	Description
IDData	Data Frame ID	Finds data frames matching the specified ID.
DATA	Data Frame ID and Data	Finds data frames matching the specified ID and data.
IDRemote	Remote Frame ID	Finds remote frames with the specified ID.
IDEither	Remote or Data Frame ID	Finds remote or data frames matching the specified ID.
ERRor	Error Frame	Finds CAN active error frames.
ACKerror	Acknowledge Error	Finds the acknowledge bit if the polarity is incorrect.
FORMerror	Form Error	Finds reserved bit errors.
STUFFerror	Stuff Error	Finds 6 consecutive 1s or 6 consecutive 0s, while in a non-error or non overload frame.
CRCerror	CRC Error	Finds when the calculated CRC does not match the transmitted CRC.
ALLerrors	All Errors	Finds any form error or active error.
OVERload	Overload Frame	Finds CAN overload frames.
MESSage	Message	Finds a symbolic message.
MSIGnal	Message and Signal (non-FD)	Finds a symbolic message and a signal value.

Query Syntax :SEARCH:SERIAL:CAN:MODE?

The :SEARCH:SERIAL:CAN:MODE? query returns the currently selected mode.

Return Format <value><NL>

```
<value> ::= {IDD | DATA | IDR | IDE | ERR | ACK | FORM | STUF | CRC
            | ALL | OVER | MESS | MSIG}
```

- See Also**
- [Chapter 30](#), “:SEARCH Commands,” starting on page 969
 - [":SEARCH:SERIAL:CAN:PATTERN:DATA"](#) on page 1009
 - [":SEARCH:SERIAL:CAN:PATTERN:ID"](#) on page 1011

- **":RECall:DBC[:START]"** on page 718
- **":SEARch:SERial:CAN:SYMBolic:MESSage"** on page 1013
- **":SEARch:SERial:CAN:SYMBolic:SIGNal"** on page 1014
- **":SEARch:SERial:CAN:SYMBolic:VALue"** on page 1015

:SEARCh:SERial:CAN:PATtern:DATA

N (see [page 1384](#))

Command Syntax :SEARCh:SERial:CAN:PATtern:DATA <string>

<string> ::= "0xnn...n" where n ::= {0,...,9 | A,...,F | X}
for hexadecimal

The :SEARCh:SERial:CAN:PATtern:DATA command specifies the data value when searching for Data Frame ID and Data.

The length of the data value is specified using the :SEARCh:SERial:CAN:PATtern:DATA:LENGth command.

Query Syntax :SEARCh:SERial:CAN:PATtern:DATA?

The :SEARCh:SERial:CAN:PATtern:DATA? query returns the current data value setting.

Return Format <string><NL>

<string> ::= "0xnn...n" where n ::= {0,...,9 | A,...,F | X}
for hexadecimal

- See Also**
- [Chapter 30](#), “:SEARCh Commands,” starting on page 969
 - [":SEARCh:SERial:CAN:MODE"](#) on page 1007
 - [":SEARCh:SERial:CAN:PATtern:DATA:LENGth"](#) on page 1010

:SEARCh:SERial:CAN:PATtern:DATA:LENGth

N (see [page 1384](#))

Command Syntax :SEARCh:SERial:CAN:PATtern:DATA:LENGth <length>
 <length> ::= integer from 1 to 8 in NR1 format

The :SEARCh:SERial:CAN:PATtern:DATA:LENGth command specifies the length of the data value when searching for Data Frame ID and Data.

The data value is specified using the :SEARCh:SERial:CAN:PATtern:DATA command.

Query Syntax :SEARCh:SERial:CAN:PATtern:DATA:LENGth?

The :SEARCh:SERial:CAN:PATtern:DATA:LENGth? query returns the current data length setting.

Return Format <length><NL>
 <length> ::= integer from 1 to 8 in NR1 format

- See Also**
- [Chapter 30](#), “:SEARCh Commands,” starting on page 969
 - [":SEARCh:SERial:CAN:MODE"](#) on page 1007
 - [":SEARCh:SERial:CAN:PATtern:DATA"](#) on page 1009

:SEARCH:SERIAL:CAN:PATTERN:ID

N (see [page 1384](#))

Command Syntax :SEARCH:SERIAL:CAN:PATTERN:ID <string>

<string> ::= "0xnn...n" where n ::= {0,...,9 | A,...,F | X}
for hexadecimal

The :SEARCH:SERIAL:CAN:PATTERN:ID command specifies the ID value when searching for a CAN event.

The value can be a standard ID or an extended ID, depending on the :SEARCH:SERIAL:CAN:PATTERN:ID:MODE command's setting.

Query Syntax :SEARCH:SERIAL:CAN:PATTERN:ID?

The :SEARCH:SERIAL:CAN:PATTERN:ID? query returns the current ID value setting.

Return Format <string><NL>

<string> ::= "0xnn...n" where n ::= {0,...,9 | A,...,F | X}
for hexadecimal

- See Also**
- [Chapter 30](#), “:SEARCH Commands,” starting on page 969
 - [":SEARCH:SERIAL:CAN:MODE"](#) on page 1007
 - [":SEARCH:SERIAL:CAN:PATTERN:ID:MODE"](#) on page 1012

:SEARCH:SERIAL:CAN:PATTERN:ID:MODE

N (see [page 1384](#))

Command Syntax :SEARCH:SERIAL:CAN:PATTERN:ID:MODE <value>
 <value> ::= {STANDARD | EXTENDED}

The :SEARCH:SERIAL:CAN:PATTERN:ID:MODE command specifies whether a standard ID value or an extended ID value is used when searching for a CAN event.

The ID value is specified using the :SEARCH:SERIAL:CAN:PATTERN:ID command.

Query Syntax :SEARCH:SERIAL:CAN:PATTERN:ID:MODE?

The :SEARCH:SERIAL:CAN:PATTERN:ID:MODE? query returns the current setting.

Return Format <value><NL>
 <value> ::= {STAN | EXT}

- See Also**
- [Chapter 30](#), “:SEARCH Commands,” starting on page 969
 - [":SEARCH:SERIAL:CAN:MODE"](#) on page 1007
 - [":SEARCH:SERIAL:CAN:PATTERN:ID"](#) on page 1011

:SEARCh:SERial:CAN:SYMBolic:MESSage

N (see [page 1384](#))

Command Syntax :SEARCh:SERial:CAN:SYMBolic:MESSage <name>

<name> ::= quoted ASCII string

The :SEARCh:SERial:CAN:SYMBolic:MESSage command specifies the message to search for when CAN symbolic data has been loaded (recalled) into the oscilloscope and the CAN serial search mode is set to MESSage or MSIGnal.

Query Syntax :SEARCh:SERial:CAN:SYMBolic:MESSage?

The :SEARCh:SERial:CAN:SYMBolic:MESSage? query returns the specified message.

Return Format <name><NL>

<name> ::= quotes ASCII string

- See Also**
- [":RECall:DBC\[:START\]"](#) on page 718
 - [":SEARCh:SERial:CAN:MODE"](#) on page 1007
 - [":SEARCh:SERial:CAN:SYMBolic:SIGNaL"](#) on page 1014
 - [":SEARCh:SERial:CAN:SYMBolic:VALue"](#) on page 1015

:SEARCH:SERIAL:CAN:SYMBOLIC:SIGNAL

N (see [page 1384](#))

Command Syntax :SEARCH:SERIAL:CAN:SYMBOLIC:SIGNAL <name>

<name> ::= quoted ASCII string

The :SEARCH:SERIAL:CAN:SYMBOLIC:SIGNAL command specifies the signal to search for when CAN symbolic data has been loaded (recalled) into the oscilloscope and the CAN serial search mode is set to MSIGNAL.

Query Syntax :SEARCH:SERIAL:CAN:SYMBOLIC:SIGNAL?

The :SEARCH:SERIAL:CAN:SYMBOLIC:SIGNAL? query returns the specified signal.

Return Format <name><NL>

<name> ::= quoted ASCII string

- See Also**
- [":RECALL:DBC\[:START\]"](#) on page 718
 - [":SEARCH:SERIAL:CAN:MODE"](#) on page 1007
 - [":SEARCH:SERIAL:CAN:SYMBOLIC:MESSAGE"](#) on page 1013
 - [":SEARCH:SERIAL:CAN:SYMBOLIC:VALUE"](#) on page 1015

:SEARCh:SERial:CAN:SYMBolic:VALue

N (see [page 1384](#))

Command Syntax :SEARCh:SERial:CAN:SYMBolic:VALue <data>
 <data> ::= value in NR3 format

The :SEARCh:SERial:CAN:SYMBolic:VALue command specifies the signal value to search for when CAN symbolic data has been loaded (recalled) into the oscilloscope and the CAN serial search mode is set to MSIGnal.

NOTE

Encoded signal values are not supported in the remote interface (even though they can be used in the front panel graphical interface).

Query Syntax :SEARCh:SERial:CAN:SYMBolic:VALue?

The :SEARCh:SERial:CAN:SYMBolic:VALue? query returns the specified signal value.

Return Format <data><NL>
 <data> ::= value in NR3 format

- See Also**
- [":RECall:DBC\[:START\]"](#) on page 718
 - [":SEARCh:SERial:CAN:MODE"](#) on page 1007
 - [":SEARCh:SERial:CAN:SYMBolic:MESSAge"](#) on page 1013
 - [":SEARCh:SERial:CAN:SYMBolic:SIGNal"](#) on page 1014

:SEARCH:SERIAL:FLEXray Commands

Table 131 :SEARCH:SERIAL:FLEXray Commands Summary

Command	Query	Options and Query Returns
:SEARCH:SERIAL:FLEXray:CYCLE <cycle> (see page 1017)	:SEARCH:SERIAL:FLEXray:CYCLE? (see page 1017)	<cycle> ::= {ALL <cycle #>} <cycle #> ::= integer from 0-63
:SEARCH:SERIAL:FLEXray:DATA <string> (see page 1018)	:SEARCH:SERIAL:FLEXray:DATA? (see page 1018)	<string> ::= "0xnn...n" where n ::= {0,...,9 A,...,F X }
:SEARCH:SERIAL:FLEXray:DATA:LENGTH <length> (see page 1019)	:SEARCH:SERIAL:FLEXray:DATA:LENGTH? (see page 1019)	<length> ::= integer from 1 to 12 in NR1 format
:SEARCH:SERIAL:FLEXray:FRAME <frame id> (see page 1020)	:SEARCH:SERIAL:FLEXray:FRAME? (see page 1020)	<frame_id> ::= {ALL <frame #>} <frame #> ::= integer from 1-2047
:SEARCH:SERIAL:FLEXray:MODE <value> (see page 1021)	:SEARCH:SERIAL:FLEXray:MODE? (see page 1021)	<value> ::= {FRAME CYCLE DATA HERRor FERRor AERRor}

:SEARCh:SERial:FLEXray:CYCLe

N (see [page 1384](#))

Command Syntax :SEARCh:SERial:FLEXray:CYCLe <cycle>

<cycle> ::= {ALL | <cycle #>}

<cycle #> ::= integer from 0-63

The :SEARCh:SERial:FLEXray:CYCLe command specifies the cycle value to find when searching for FlexRay frames.

A cycle value of -1 is the same as ALL.

Query Syntax :SEARCh:SERial:FLEXray:CYCLe?

The :SEARCh:SERial:FLEXray:CYCLe? query returns the current cycle value setting.

Return Format <cycle><NL>

<cycle> ::= {ALL | <cycle #>}

<cycle #> ::= integer from 0-63

- See Also**
- [Chapter 30](#), “:SEARCh Commands,” starting on page 969
 - [":SEARCh:SERial:FLEXray:MODE"](#) on page 1021

:SEARCH:SERIAL:FLEXray:DATA

N (see [page 1384](#))

Command Syntax :SEARCH:SERIAL:FLEXray:DATA <string>

<string> ::= "0xnn...n" where n ::= {0,...,9 | A,...,F | X }

The :SEARCH:SERIAL:FLEXray:DATA command specifies the data value to find when searching for FlexRay frames.

The length of the data value is specified by the :SEARCH:SERIAL:FLEXray:DATA:LENGTH command.

Query Syntax :SEARCH:SERIAL:FLEXray:DATA?

The :SEARCH:SERIAL:FLEXray:DATA? query returns the current data value setting.

Return Format <string><NL>

<string> ::= "0xnn...n" where n ::= {0,...,9 | A,...,F | X }

- See Also**
- [Chapter 30](#), “:SEARCH Commands,” starting on page 969
 - [":SEARCH:SERIAL:FLEXray:MODE"](#) on page 1021
 - [":SEARCH:SERIAL:FLEXray:DATA:LENGTH"](#) on page 1019

:SEARCh:SERial:FLEXray:DATA:LENGth

N (see [page 1384](#))

Command Syntax :SEARCh:SERial:FLEXray:DATA:LENGth <length>

<length> ::= integer from 1 to 12 in NR1 format

The :SEARCh:SERial:FLEXray:DATA:LENGth command specifies the length of data values when searching for FlexRay frames.

The data value is specified using the :SEARCh:SERial:FLEXray:DATA command.

Query Syntax :SEARCh:SERial:FLEXray:DATA:LENGth?

The :SEARCh:SERial:FLEXray:DATA:LENGth? query returns the current data length setting.

Return Format <length><NL>

<length> ::= integer from 1 to 12 in NR1 format

- See Also**
- [Chapter 30](#), “:SEARCh Commands,” starting on page 969
 - [":SEARCh:SERial:FLEXray:MODE"](#) on page 1021
 - [":SEARCh:SERial:FLEXray:DATA"](#) on page 1018

:SEARCH:SERIAL:FLEXray:FRAME

N (see [page 1384](#))

Command Syntax :SEARCH:SERIAL:FLEXray:FRAME <frame_id>

<frame_id> ::= {ALL | <frame #>}

<frame #> ::= integer from 1-2047

The :SEARCH:SERIAL:FLEXray:FRAME command specifies the frame ID value to find when searching for FlexRay frames.

Query Syntax :SEARCH:SERIAL:FLEXray:FRAME?

The :SEARCH:SERIAL:FLEXray:FRAME? query returns the current frame ID setting.

Return Format <frame_id><NL>

<frame_id> ::= {ALL | <frame #>}

<frame #> ::= integer from 1-2047

- See Also**
- [Chapter 30](#), “:SEARCH Commands,” starting on page 969
 - [":SEARCH:SERIAL:FLEXray:MODE"](#) on page 1021

:SEARCh:SERial:FLEXray:MODE

N (see [page 1384](#))

Command Syntax :SEARCh:SERial:FLEXray:MODE <value>

<value> := {FRAMe | CYCLe | DATA | HERRor | FERRor | AERRor}

The :SEARCh:SERial:FLEXray:MODE command selects the type of FlexRay information to find in the Lister display:

- FRAMe – searches for FlexRay frames with the specified frame ID.
- CYCLe – searches for FlexRay frames with the specified cycle number and frame ID.
- DATA – searches for FlexRay frames with the specified data, cycle number, and frame ID.
- HERRor – searches for header CRC errors.
- FERRor – searches for frame CRC errors.
- AERRor – searches for all errors.

Query Syntax :SEARCh:SERial:FLEXray:MODE?

The :SEARCh:SERial:FLEXray:MODE? query returns the currently selected mode.

Return Format <value><NL>

<value> := {FRAM | CYCL | DATA | HERR | FERR | AERR}

- See Also**
- [Chapter 30](#), “:SEARCh Commands,” starting on page 969
 - [":SEARCh:SERial:FLEXray:FRAMe"](#) on page 1020
 - [":SEARCh:SERial:FLEXray:CYCLe"](#) on page 1017
 - [":SEARCh:SERial:FLEXray:DATA"](#) on page 1018

:SEARCH:SERIAL:I2S Commands

Table 132:SEARCH:SERIAL:I2S Commands Summary

Command	Query	Options and Query Returns
:SEARCH:SERIAL:I2S:AUDIO <audio_ch> (see page 1023)	:SEARCH:SERIAL:I2S:AUDIO? (see page 1023)	<audio_ch> ::= {RIGHT LEFT EITHER}
:SEARCH:SERIAL:I2S:MODE <value> (see page 1024)	:SEARCH:SERIAL:I2S:MODE? (see page 1024)	<value> ::= {EQUAL NOTEQUAL LESSTHAN GREATERTHAN INRANGE OTRANGE}
:SEARCH:SERIAL:I2S:PARTtern:DATA <string> (see page 1025)	:SEARCH:SERIAL:I2S:PARTtern:DATA? (see page 1025)	<string> ::= "n" where n ::= 32-bit integer in signed decimal when <base> = DECIMAL <string> ::= "nn...n" where n ::= {0 1 X} when <base> = BINARY <string> ::= "0xnn...n" where n ::= {0,...,9 A,...,F X} when <base> = HEX
:SEARCH:SERIAL:I2S:PARTtern:FORMAT <base> (see page 1026)	:SEARCH:SERIAL:I2S:PARTtern:FORMAT? (see page 1026)	<base> ::= {BINARY HEX DECIMAL}
:SEARCH:SERIAL:I2S:RANGE <lower>, <upper> (see page 1027)	:SEARCH:SERIAL:I2S:RANGE? (see page 1027)	<lower> ::= 32-bit integer in signed decimal, <nondecimal>, or <string> <upper> ::= 32-bit integer in signed decimal, <nondecimal>, or <string> <nondecimal> ::= #Hnn...n where n ::= {0,...,9 A,...,F} for hexadecimal <nondecimal> ::= #Bnn...n where n ::= {0 1} for binary <string> ::= "0xnn...n" where n ::= {0,...,9 A,...,F} for hexadecimal

:SEARCh:SERial:I2S:AUDio

N (see [page 1384](#))

Command Syntax :SEARCh:SERial:I2S:AUDio <audio_ch>

<audio_ch> ::= {RIGHT | LEFT | EITHER}

The :SEARCh:SERial:I2S:AUDio command specifies the channel on which to search for I2S events: right, left, or either channel.

Query Syntax :SEARCh:SERial:I2S:AUDio?

The :SEARCh:SERial:I2S:AUDio? query returns the current channel setting.

Return Format <audio_ch><NL>

<audio_ch> ::= {RIGH | LEFT | EITH}

- See Also**
- [Chapter 30](#), “:SEARCh Commands,” starting on page 969
 - [":SEARCh:SERial:I2S:MODE"](#) on page 1024

:SEARCH:SERIAL:I2S:MODE

N (see [page 1384](#))

Command Syntax :SEARCH:SERIAL:I2S:MODE <value>

<value> ::= {EQUAL | NOTequal | LESSthan | GREATERthan | INRange
| OUTRange}

The :SEARCH:SERIAL:I2S:MODE command selects the type of I2S information to find in the Lister display:

- EQUAL— searches for the specified audio channel's data word when it equals the specified word.
- NOTequal – searches for any word other than the specified word.
- LESSthan – searches for channel data words less than the specified value.
- GREATERthan – searches for channel data words greater than the specified value.
- INRange – searches for channel data words in the range.
- OUTRange – searches for channel data words outside the range.

Data word values are specified using the :SEARCH:SERIAL:I2S:PATTERN:DATA command.

Value ranges are specified using the :SEARCH:SERIAL:I2S:RANGE command.

Query Syntax :SEARCH:SERIAL:I2S:MODE?

The :SEARCH:SERIAL:I2S:MODE? query returns the currently selected mode.

Return Format <value><NL>

<value> ::= {EQU | NOT | LESS | GRE | INR | OUTR}

- See Also**
- [Chapter 30](#), “:SEARCH Commands,” starting on page 969
 - [":SEARCH:SERIAL:I2S:PATTERN:DATA"](#) on page 1025
 - [":SEARCH:SERIAL:I2S:RANGE"](#) on page 1027
 - [":SEARCH:SERIAL:I2S:AUDIO"](#) on page 1023

:SEARCh:SERial:I2S:PATtern:DATA

N (see [page 1384](#))

Command Syntax :SEARCh:SERial:I2S:PATtern:DATA <string>

<string> ::= "n" where n ::= 32-bit integer in signed decimal
when <base> = DECimal

<string> ::= "nn...n" where n ::= {0 | 1 | X} when <base> = BINary

<string> ::= "0xnn...n" where n ::= {0,...,9 | A,...,F | X}
when <base> = HEX

The :SEARCh:SERial:I2S:PATtern:DATA command specifies the data word value when searching for I2S events.

The base of the value entered with this command is specified using the :SEARCh:SERial:I2S:PATtern:FORMat command.

Query Syntax :SEARCh:SERial:I2S:PATtern:DATA?

The :SEARCh:SERial:I2S:PATtern:DATA? query returns the current data word value setting.

Return Format <string><NL>

<string> ::= "n" where n ::= 32-bit integer in signed decimal
when <base> = DECimal

<string> ::= "nn...n" where n ::= {0 | 1 | X} when <base> = BINary

<string> ::= "0xnn...n" where n ::= {0,...,9 | A,...,F | X}
when <base> = HEX

- See Also**
- [Chapter 30](#), “:SEARCh Commands,” starting on page 969
 - [":SEARCh:SERial:I2S:MODE"](#) on page 1024
 - [":SEARCh:SERial:I2S:PATtern:FORMat"](#) on page 1026

:SEARCH:SERIAL:I2S:PATTERN:FORMAT

N (see [page 1384](#))

Command Syntax :SEARCH:SERIAL:I2S:PATTERN:FORMAT <base>
 <base> ::= {BINARY | HEX | DECIMAL}

The :SEARCH:SERIAL:I2S:PATTERN:FORMAT command specifies the number base used with the :SEARCH:SERIAL:I2S:PATTERN:DATA command.

Query Syntax :SEARCH:SERIAL:I2S:PATTERN:FORMAT?

The :SEARCH:SERIAL:I2S:PATTERN:FORMAT? query returns the current number base setting.

Return Format <base><NL>
 <base> ::= {BIN | HEX | DEC}

- See Also**
- [Chapter 30](#), “:SEARCH Commands,” starting on page 969
 - [":SEARCH:SERIAL:I2S:PATTERN:DATA"](#) on page 1025

:SEARCh:SERial:I2S:RANGe

N (see [page 1384](#))

Command Syntax :SEARCh:SERial:I2S:RANGe <lower>, <upper>

<lower> ::= 32-bit integer in signed decimal, <nondecimal>, or <string>

<upper> ::= 32-bit integer in signed decimal, <nondecimal>, or <string>

<nondecimal> ::= #Hnn...n where n ::= {0,...,9 | A,...,F} for hexadecimal

<nondecimal> ::= #Bnn...n where n ::= {0 | 1} for binary

<string> ::= "0xnn...n" where n ::= {0,...,9 | A,...,F} for hexadecimal

The :SEARCh:SERial:I2S:RANGe command specifies the data value range when searching for I2S events in the INRange and OUTRange search modes (set by the :SEARCh:SERial:I2S:MODE command).

You can enter the parameters in any order – the smaller value becomes the <lower> and the larger value becomes the <upper>.

Query Syntax :SEARCh:SERial:I2S:RANGe?

The :SEARCh:SERial:I2S:RANGe? query returns the current data value range setting.

Return Format <lower>, <upper><NL>

<lower> ::= 32-bit integer in signed decimal

<upper> ::= 32-bit integer in signed decimal

- See Also**
- [Chapter 30](#), “:SEARCh Commands,” starting on page 969
 - [":SEARCh:SERial:I2S:MODE"](#) on page 1024

:SEARCH:SERIAL:IIC Commands

Table 133:SEARCH:SERIAL:IIC Commands Summary

Command	Query	Options and Query Returns
:SEARCH:SERIAL:IIC:MODE <value> (see page 1029)	:SEARCH:SERIAL:IIC:MODE? (see page 1029)	<value> ::= { READ7 WRITE7 NACKnowledge ANACK R7Data2 W7Data2 REStart READEprom }
:SEARCH:SERIAL:IIC:PARTern:ADDRESS <value> (see page 1031)	:SEARCH:SERIAL:IIC:PARTern:ADDRESS? (see page 1031)	<value> ::= integer or <string> <string> ::= "0xnn" n ::= {0,...,9 A,...,F}
:SEARCH:SERIAL:IIC:PARTern:DATA <value> (see page 1032)	:SEARCH:SERIAL:IIC:PARTern:DATA? (see page 1032)	<value> ::= integer or <string> <string> ::= "0xnn" n ::= {0,...,9 A,...,F}
:SEARCH:SERIAL:IIC:PARTern:DATA2 <value> (see page 1033)	:SEARCH:SERIAL:IIC:PARTern:DATA2? (see page 1033)	<value> ::= integer or <string> <string> ::= "0xnn" n ::= {0,...,9 A,...,F}
:SEARCH:SERIAL:IIC:QUALifier <value> (see page 1034)	:SEARCH:SERIAL:IIC:QUALifier? (see page 1034)	<value> ::= {EQUal NOTequal LESSthan GREATERthan}

:SEARCh:SERial:IIC:MODE

N (see [page 1384](#))

Command Syntax :SEARCh:SERial:IIC:MODE <value>

```
<value> ::= {READ7 | WRITe7 | NACKnowledge | ANACK | R7Data2
             | W7Data2 | REStart | READEprom}
```

The :SEARCh:SERial:IIC:MODE command selects the type of IIC information to find in the Lister display:

- READ7 – searches for 7-bit address frames containing Start:Address7:Read:Ack:Data. The value READ is also accepted for READ7.
- WRITe7 – searches for 7-bit address frames containing Start:Address7:Write:Ack:Data. The value WRITe is also accepted for WRITe7.
- NACKnowledge – searches for missing acknowledge events.
- ANACK – searches for address with no acknowledge events.
- R7Data2 – searches for 7-bit address frames containing Start:Address7:Read:Ack:Data:Ack:Data2.
- W7Data2 – searches for 7-bit address frames containing Start:Address7:Write:Ack:Data:Ack:Data2.
- REStart – searches for another start condition occurring before a stop condition.
- READEprom – searches for EEPROM data reads.

NOTE

The short form of READ7 (READ7), READEprom (READE), and WRITe7 (WRIT7) do not follow the defined Long Form to Short Form Truncation Rules (see [page 1386](#)).

When searching for events containing addresses, address values are specified using the :SEARCh:SERial:IIC:PATtern:ADDReSS command.

When searching for events containing data, data values are specified using the :SEARCh:SERial:IIC:PATtern:DATA and :SEARCh:SERial:IIC:PATtern:DATA2 commands.

Query Syntax :SEARCh:SERial:IIC:MODE?

The :SEARCh:SERial:IIC:MODE? query returns the currently selected mode.

Return Format <value><NL>

```
<value> ::= {READ7 | WRITe7 | NACK | ANAC | R7D2 | W7D2 | REST
             | READE}
```

- See Also**
- [Chapter 30](#), “:SEARCh Commands,” starting on page 969
 - [":SEARCh:SERial:IIC:PATtern:ADDReSS"](#) on page 1031
 - [":SEARCh:SERial:IIC:PATtern:DATA"](#) on page 1032

- **":SEARch:SERial:IC:PATtern:DATA2"** on page 1033
- **":SEARch:SERial:IC:QUALifier"** on page 1034

:SEARCh:SERial:IIC:PATtern:ADDRess

N (see [page 1384](#))

Command Syntax :SEARCh:SERial:IIC:PATtern:ADDRess <value>

<value> ::= integer or <string>

<string> ::= "0xnn" n ::= {0,...,9 | A,...,F}

The :SEARCh:SERial:IIC:PATtern:ADDRess command specifies address values when searching for IIC events.

To set don't care values, use the integer -1.

Query Syntax :SEARCh:SERial:IIC:PATtern:ADDRess?

The :SEARCh:SERial:IIC:PATtern:ADDRess? query returns the current address value setting.

Return Format <value><NL>

<value> ::= integer

- See Also**
- [Chapter 30](#), “:SEARCh Commands,” starting on page 969
 - [":SEARCh:SERial:IIC:MODE"](#) on page 1029

:SEARCH:SERIAL:IIC:PATTERN:DATA

N (see [page 1384](#))

Command Syntax :SEARCH:SERIAL:IIC:PATTERN:DATA <value>

<value> ::= integer or <string>

<string> ::= "0xnn" n ::= {0,...,9 | A,...,F}

The :SEARCH:SERIAL:IIC:PATTERN:DATA command specifies data values when searching for IIC events.

To set don't care values, use the integer -1.

When searching for IIC EEPROM data read events, you specify the data value qualifier using the :SEARCH:SERIAL:IIC:QUALIFIER command.

Query Syntax :SEARCH:SERIAL:IIC:PATTERN:DATA?

The :SEARCH:SERIAL:IIC:PATTERN:DATA? query returns the current data value setting.

Return Format <value><NL>

<value> ::= integer

- See Also**
- [Chapter 30](#), “:SEARCH Commands,” starting on page 969
 - [":SEARCH:SERIAL:IIC:MODE"](#) on page 1029
 - [":SEARCH:SERIAL:IIC:QUALIFIER"](#) on page 1034
 - [":SEARCH:SERIAL:IIC:PATTERN:DATA2"](#) on page 1033

:SEARCh:SERial:IIC:PATtern:DATA2

N (see [page 1384](#))

Command Syntax :SEARCh:SERial:IIC:PATtern:DATA2 <value>

<value> ::= integer or <string>

<string> ::= "0xnn" n ::= {0,...,9 | A,...,F}

The :SEARCh:SERial:IIC:PATtern:DATA2 command specifies the second data value when searching for IIC events with two data values.

To set don't care values, use the integer -1.

Query Syntax :SEARCh:SERial:IIC:PATtern:DATA2?

The :SEARCh:SERial:IIC:PATtern:DATA2? query returns the current second data value setting.

Return Format <value><NL>

<value> ::= integer

- See Also**
- [Chapter 30](#), “:SEARCh Commands,” starting on page 969
 - [":SEARCh:SERial:IIC:MODE"](#) on page 1029
 - [":SEARCh:SERial:IIC:PATtern:DATA"](#) on page 1032

:SEARCH:SERIAL:IIC:QUALifier

N (see [page 1384](#))

Command Syntax :SEARCH:SERIAL:IIC:QUALifier <value>

<value> ::= {EQUAL | NOTequal | LESSthan | GREATERthan}

The :SEARCH:SERIAL:IIC:QUALifier command specifies the data value qualifier used when searching for IIC EEPROM data read events.

Query Syntax :SEARCH:SERIAL:IIC:QUALifier?

The :SEARCH:SERIAL:IIC:QUALifier? query returns the current data value qualifier setting.

Return Format <value><NL>

<value> ::= {EQU | NOT | LESS | GRE}

- See Also**
- [Chapter 30](#), “:SEARCH Commands,” starting on page 969
 - [":SEARCH:SERIAL:IIC:MODE"](#) on page 1029
 - [":SEARCH:SERIAL:IIC:PATTERN:DATA"](#) on page 1032

:SEARCh:SERIAL:LIN Commands

Table 134:SEARCh:SERIAL:LIN Commands Summary

Command	Query	Options and Query Returns
:SEARCh:SERIAL:LIN:ID <value> (see page 1036)	:SEARCh:SERIAL:LIN:ID ? (see page 1036)	<value> ::= 7-bit integer in decimal, <nondecimal>, or <string> from 0-63 or 0x00-0x3f (with Option AMS) <nondecimal> ::= #Hnn where n ::= {0,...,9 A,...,F} for hexadecimal <nondecimal> ::= #Bnn...n where n ::= {0 1} for binary <string> ::= "0xnn" where n ::= {0,...,9 A,...,F} for hexadecimal
:SEARCh:SERIAL:LIN:MODE <value> (see page 1037)	:SEARCh:SERIAL:LIN:MODE? (see page 1037)	<value> ::= {ID DATA ERROR}
:SEARCh:SERIAL:LIN:PATTERN:DATA <string> (see page 1038)	:SEARCh:SERIAL:LIN:PATTERN:DATA? (see page 1038)	When :SEARCh:SERIAL:LIN:PATTERN:FORMAT DECIMAL, <string> ::= "n" where n ::= 32-bit integer in unsigned decimal, returns "\$" if data has any don't cares When :SEARCh:SERIAL:LIN:PATTERN:FORMAT HEX, <string> ::= "0xnn...n" where n ::= {0,...,9 A,...,F X }
:SEARCh:SERIAL:LIN:PATTERN:DATA:LENGTH <length> (see page 1039)	:SEARCh:SERIAL:LIN:PATTERN:DATA:LENGTH? (see page 1039)	<length> ::= integer from 1 to 8 in NR1 format
:SEARCh:SERIAL:LIN:PATTERN:FORMAT <base> (see page 1040)	:SEARCh:SERIAL:LIN:PATTERN:FORMAT? (see page 1040)	<base> ::= {HEX DECIMAL}
:SEARCh:SERIAL:LIN:SYMBOLIC:FRAME <name> (see page 1041)	:SEARCh:SERIAL:LIN:SYMBOLIC:FRAME? (see page 1041)	<name> ::= quoted ASCII string
:SEARCh:SERIAL:LIN:SYMBOLIC:SIGNAL <name> (see page 1042)	:SEARCh:SERIAL:LIN:SYMBOLIC:SIGNAL? (see page 1042)	<name> ::= quoted ASCII string
:SEARCh:SERIAL:LIN:SYMBOLIC:VALUE <data> (see page 1043)	:SEARCh:SERIAL:LIN:SYMBOLIC:VALUE? (see page 1043)	<data> ::= value in NR3 format

:SEARCH:SERIAL:LIN:ID

N (see [page 1384](#))

Command Syntax :SEARCH:SERIAL:LIN:ID <value>

<value> ::= 7-bit integer in decimal, <nondecimal>, or <string>
from 0-63 or 0x00-0x3f (with Option AMS)

<nondecimal> ::= #Hnn where n ::= {0,...,9 | A,...,F} for hexadecimal

<nondecimal> ::= #Bnn...n where n ::= {0 | 1} for binary

<string> ::= "0xnn" where n ::= {0,...,9 | A,...,F} for hexadecimal

The :SEARCH:SERIAL:LIN:ID command specifies the frame ID value when searching for LIN events.

Query Syntax :SEARCH:SERIAL:LIN:ID?

The :SEARCH:SERIAL:LIN:ID? query returns the current frame ID setting.

Return Format <value><NL>

<value> ::= 7-bit integer in decimal (with Option AMS)

- See Also**
- [Chapter 30](#), “:SEARCH Commands,” starting on page 969
 - [":SEARCH:SERIAL:LIN:MODE"](#) on page 1037

:SEARCh:SERial:LIN:MODE

N (see [page 1384](#))

Command Syntax :SEARCh:SERial:LIN:MODE <value>

<value> ::= {ID | DATA | ERRor | FRAMe | FSIGnal}

The :SEARCh:SERial:LIN:MODE command selects the type of LIN information to find in the Lister display:

- ID – searches for a frame ID.
- DATA – searches for a frame ID and data.
- ERRor – searches for errors.
- FRAMe – searches for symbolic frames.
- FSIGnal – searched for symbolic frames and a signal values.

Frame IDs are specified using the :SEARCh:SERial:LIN:ID command.

Data values are specified using the :SEARCh:SERial:LIN:PATtern:DATA command.

Frames, signals, and signal values are specified using the :SEARCh:SERial:LIN:SYMBolic:FRAMe, :SEARCh:SERial:LIN:SYMBolic:SIGnal, and :SEARCh:SERial:LIN:SYMBolic:VALue commands. LIN symbolic data files are loaded (recalled) using the :RECall:LDF[:START] command.

Query Syntax :SEARCh:SERial:LIN:MODE?

The :SEARCh:SERial:LIN:MODE? query returns the currently selected mode.

Return Format <value><NL>

<value> ::= {ID | DATA | ERR | FRAM | FSIG}

- See Also**
- [Chapter 30](#), “:SEARCh Commands,” starting on page 969
 - [":SEARCh:SERial:LIN:ID"](#) on page 1036
 - [":SEARCh:SERial:LIN:PATtern:DATA"](#) on page 1038
 - [":RECall:LDF\[:START\]"](#) on page 720
 - [":SEARCh:SERial:LIN:SYMBolic:FRAMe"](#) on page 1041
 - [":SEARCh:SERial:LIN:SYMBolic:SIGnal"](#) on page 1042
 - [":SEARCh:SERial:LIN:SYMBolic:VALue"](#) on page 1043

:SEARCH:SERIAL:LIN:PATTERN:DATA

N (see [page 1384](#))

Command Syntax :SEARCH:SERIAL:LIN:PATTERN:DATA <string>

When :SEARCH:SERIAL:LIN:PATTERN:FORMAT DECIMAL,
<string> ::= "n" where n ::= 32-bit integer in unsigned decimal

When :SEARCH:SERIAL:LIN:PATTERN:FORMAT HEX,
<string> ::= "0xnn...n" where n ::= {0,...,9 | A,...,F | X }

The :SEARCH:SERIAL:LIN:PATTERN:DATA command specifies the data value when searching for LIN events.

The number base of the value entered with this command is specified using the :SEARCH:SERIAL:LIN:PATTERN:FORMAT command. To set don't care values with the DATA command, the FORMAT must be HEX.

The length of the data value entered is specified using the :SEARCH:SERIAL:LIN:PATTERN:DATA:LENGTH command.

Query Syntax :SEARCH:SERIAL:LIN:PATTERN:DATA?

The :SEARCH:SERIAL:LIN:PATTERN:DATA? query returns the current data value setting.

Return Format <string><NL>

When :SEARCH:SERIAL:LIN:PATTERN:FORMAT DECIMAL,
<string> ::= "n" where n ::= 32-bit integer in unsigned decimal or "\$" if data has any don't cares

When :SEARCH:SERIAL:LIN:PATTERN:FORMAT HEX,
<string> ::= "0xnn...n" where n ::= {0,...,9 | A,...,F | X }

- See Also**
- [Chapter 30](#), “:SEARCH Commands,” starting on page 969
 - [":SEARCH:SERIAL:LIN:MODE"](#) on page 1037
 - [":SEARCH:SERIAL:LIN:PATTERN:FORMAT"](#) on page 1040
 - [":SEARCH:SERIAL:LIN:PATTERN:DATA:LENGTH"](#) on page 1039

:SEARCh:SERial:LIN:PATtern:DATA:LENGth

N (see [page 1384](#))

Command Syntax :SEARCh:SERial:LIN:PATtern:DATA:LENGth <length>
 <length> ::= integer from 1 to 8 in NR1 format

The :SEARCh:SERial:LIN:PATtern:DATA:LENGth command specifies the the length of the data value when searching for LIN events.

The data value is specified using the :SEARCh:SERial:LIN:PATtern:DATA command.

Query Syntax :SEARCh:SERial:LIN:PATtern:DATA:LENGth?

The :SEARCh:SERial:LIN:PATtern:DATA:LENGth? query returns the current data value length setting.

Return Format <length><NL>
 <length> ::= integer from 1 to 8 in NR1 format

- See Also**
- [Chapter 30](#), “:SEARCh Commands,” starting on page 969
 - [":SEARCh:SERial:LIN:PATtern:DATA"](#) on page 1038

:SEARCH:SERIAL:LIN:PATTERN:FORMAT

N (see [page 1384](#))

Command Syntax :SEARCH:SERIAL:LIN:PATTERN:FORMAT <base>
 <base> ::= {HEX | DECIMAL}

The :SEARCH:SERIAL:LIN:PATTERN:FORMAT command specifies the number base used with the :SEARCH:SERIAL:LIN:PATTERN:DATA command.

Query Syntax :SEARCH:SERIAL:LIN:PATTERN:FORMAT?

The :SEARCH:SERIAL:LIN:PATTERN:FORMAT? query returns the current number base setting.

Return Format <base><NL>
 <base> ::= {HEX | DEC}

- See Also**
- [Chapter 30](#), “:SEARCH Commands,” starting on page 969
 - [":SEARCH:SERIAL:LIN:PATTERN:DATA"](#) on page 1038

:SEARCh:SERial:LIN:SYMBolic:FRAME

N (see [page 1384](#))

Command Syntax :SEARCh:SERial:LIN:SYMBolic:FRAME <name>

<name> ::= quoted ASCII string

The :SEARCh:SERial:LIN:SYMBolic:FRAME command specifies the message to search for when LIN symbolic data has been loaded (recalled) into the oscilloscope and the LIN serial search mode is set to FRAME or FSIGNAL.

Query Syntax :SEARCh:SERial:LIN:SYMBolic:FRAME?

The :SEARCh:SERial:LIN:SYMBolic:FRAME? query returns the specified message.

Return Format <name><NL>

<name> ::= quotes ASCII string

- See Also**
- [":RECall:LDF\[:START\]"](#) on page 720
 - [":SEARCh:SERial:LIN:MODE"](#) on page 1037
 - [":SEARCh:SERial:LIN:SYMBolic:SIGNal"](#) on page 1042
 - [":SEARCh:SERial:LIN:SYMBolic:VALue"](#) on page 1043

:SEARCh:SERial:LIN:SYMBolic:SIGNal

N (see [page 1384](#))

Command Syntax :SEARCh:SERial:LIN:SYMBolic:SIGNal <name>

<name> ::= quoted ASCII string

The :SEARCh:SERial:LIN:SYMBolic:SIGNal command specifies the signal to search for when LIN symbolic data has been loaded (recalled) into the oscilloscope and the LIN serial search mode is set to FSiGnal.

Query Syntax :SEARCh:SERial:LIN:SYMBolic:SIGNal?

The :SEARCh:SERial:LIN:SYMBolic:SIGNal? query returns the specified signal.

Return Format <name><NL>

<name> ::= quoted ASCII string

- See Also**
- [":RECall:LDF\[:START\]"](#) on page 720
 - [":SEARCh:SERial:LIN:MODE"](#) on page 1037
 - [":SEARCh:SERial:LIN:SYMBolic:FRAMe"](#) on page 1041
 - [":SEARCh:SERial:LIN:SYMBolic:VALue"](#) on page 1043

:SEARCh:SERial:LIN:SYMBolic:VALue

N (see [page 1384](#))

Command Syntax :SEARCh:SERial:LIN:SYMBolic:VALue <data>

<data> ::= value in NR3 format

The :SEARCh:SERial:LIN:SYMBolic:VALue command specifies the signal value to search for when LIN symbolic data has been loaded (recalled) into the oscilloscope and the LIN serial search mode is set to FSIGNAL.

NOTE

Encoded signal values are not supported in the remote interface (even though they can be used in the front panel graphical interface).

Query Syntax :SEARCh:SERial:LIN:SYMBolic:VALue?

The :SEARCh:SERial:LIN:SYMBolic:VALue? query returns the specified signal value.

Return Format <data><NL>

<data> ::= value in NR3 format

- See Also**
- [":RECall:LDF\[:START\]"](#) on page 720
 - [":SEARCh:SERial:LIN:MODE"](#) on page 1037
 - [":SEARCh:SERial:LIN:SYMBolic:FRAMe"](#) on page 1041
 - [":SEARCh:SERial:LIN:SYMBolic:SIGNal"](#) on page 1042

:SEARCH:SERIAL:M1553 Commands

Table 135:SEARCH:SERIAL:M1553 Commands Summary

Command	Query	Options and Query Returns
:SEARCH:SERIAL:M1553:MODE <value> (see page 1045)	:SEARCH:SERIAL:M1553:MODE? (see page 1045)	<value> ::= {DStArt CStArt RTA RTA11 PERRor SERRor MERRor}
:SEARCH:SERIAL:M1553:PATtern:DATA <string> (see page 1046)	:SEARCH:SERIAL:M1553:PATtern:DATA? (see page 1046)	<string> ::= "nn...n" where n ::= {0 1}
:SEARCH:SERIAL:M1553:RTA <value> (see page 1047)	:SEARCH:SERIAL:M1553:RTA? (see page 1047)	<value> ::= 5-bit integer in decimal, <hexadecimal>, <binary>, or <string> from 0-31 < hexadecimal > ::= #Hnn where n ::= {0,...,9 A,...,F} <binary> ::= #Bnn...n where n ::= {0 1} for binary <string> ::= "0xnn" where n ::= {0,...,9 A,...,F}

:SEARCh:SERial:M1553:MODE

N (see [page 1384](#))

Command Syntax :SEARCh:SERial:M1553:MODE <value>

<value> ::= {DStArt | CStArt | RTA | RTA11 | PERRor | SERRor | MERRor}

The :SEARCh:SERial:M1553:MODE command selects the type of MIL-STD-1553 information to find in the Lister display:

- DStArt – searches for the start of a Data word (at the end of a valid Data Sync pulse).
- CStArt – searches for the start of a Command/Status word (at the end of a valid C/S Sync pulse).
- RTA – searches for the Remote Terminal Address (RTA) of a Command/Status word.
- RTA11 – searches for the Remote Terminal Address (RTA) and the additional 11 bits of a Command/Status word.
- PERRor – searches for (odd) parity errors for the data in the word.
- SERRor – searches for invalid Sync pulses.
- MERRor – searches for Manchester encoding errors.

In the RTA or RTA11 modes, the Remote Terminal Address is specified using the :SEARCh:SERial:M1553:RTA command.

In the RTA11 mode, the additional 11 bits are specified using the :SEARCh:SERial:M1553:PATtern:DATA command.

Query Syntax :SEARCh:SERial:M1553:MODE?

The :SEARCh:SERial:M1553:MODE? query returns the currently selected mode.

Return Format <value><NL>

<value> ::= {DStA | CStA | RTA | RTA11 | PERR | SERR | MERR}

- See Also**
- [Chapter 30](#), “:SEARCh Commands,” starting on page 969
 - [":SEARCh:SERial:M1553:RTA"](#) on page 1047
 - [":SEARCh:SERial:M1553:PATtern:DATA"](#) on page 1046

:SEARCh:SERial:M1553:PATtern:DATA

N (see [page 1384](#))

Command Syntax :SEARCh:SERial:M1553:PATtern:DATA <string>
 <string> ::= "nn...n" where n ::= {0 | 1}

The :SEARCh:SERial:M1553:PATtern:DATA command specifies the additional 11 bits when searching for the MIL-STD-1553 Remote Terminal Address + 11 Bits.

Query Syntax :SEARCh:SERial:M1553:PATtern:DATA?

The :SEARCh:SERial:M1553:PATtern:DATA? query returns the current value setting for the additional 11 bits.

Return Format <string><NL>
 <string> ::= "nn...n" where n ::= {0 | 1}

- See Also**
- [Chapter 30](#), “:SEARCh Commands,” starting on page 969
 - [":SEARCh:SERial:M1553:MODE"](#) on page 1045

:SEARCh:SERial:M1553:RTA

N (see [page 1384](#))

Command Syntax :SEARCh:SERial:M1553:RTA <value>

<value> ::= 5-bit integer in decimal, <hexadecimal>, <binary>, or <string> from 0-31

<hexadecimal> ::= #Hnn where n ::= {0,...,9|A,...,F}

<binary> ::= #Bnn...n where n ::= {0 | 1} for binary

<string> ::= "0xnn" where n ::= {0,...,9|A,...,F}

The :SEARCh:SERial:M1553:RTA command specifies the Remote Terminal Address (RTA) value when searching for MIL-STD-1553 events.

Query Syntax :SEARCh:SERial:M1553:RTA?

The :SEARCh:SERial:M1553:RTA? query returns the current Remote Terminal Address value setting.

Return Format <value><NL>

<value> ::= 5-bit integer in decimal from 0-31

See Also • [Chapter 30](#), “:SEARCh Commands,” starting on page 969

:SEARCH:SERIAL:SENT Commands

Table 136:SEARCH:SERIAL:SENT Commands Summary

Command	Query	Options and Query Returns
:SEARCH:SERIAL:SENT:F AST:DATA <string> (see page 1049)	:SEARCH:SERIAL:SENT:F AST:DATA? (see page 1049)	<string> ::= "0xn..." where n ::= {0,...,9 A,...,F X \$}
:SEARCH:SERIAL:SENT:M ODE <mode> (see page 1050)	:SEARCH:SERIAL:SENT:M ODE? (see page 1050)	<mode> ::= {FCData SCMid SCData CRCerror PPErrror}
:SEARCH:SERIAL:SENT:S LOW:DATA <data> (see page 1051)	:SEARCH:SERIAL:SENT:S LOW:DATA? (see page 1051)	<data> ::= from -1 (don't care) to 65535, in NR1 format.
:SEARCH:SERIAL:SENT:S LOW:ID <id> (see page 1052)	:SEARCH:SERIAL:SENT:S LOW:ID? (see page 1052)	<id> ::= from -1 (don't care) to 255, in NR1 format.

:SEARCh:SERial:SENT:FAST:DATA

N (see [page 1384](#))

Command Syntax :SEARCh:SERial:SENT:FAST:DATA <string>

<string> ::= "0xn..." where n ::= {0,...,9 | A,...,F | X | \$}

The :SEARCh:SERial:SENT:FAST:DATA command specifies the status and data nibbles that will be searched for when the FCData search mode is chosen.

Query Syntax :SEARCh:SERial:SENT:FAST:DATA?

The :SEARCh:SERial:SENT:FAST:DATA? query returns the fast channel data search value setting.

Return Format <string><NL>

<string> ::= "0xn..." where n ::= {0,...,9 | A,...,F | X | \$}

- See Also**
- [":SEARCh:SERial:SENT:MODE"](#) on page 1050
 - [":SEARCh:SERial:SENT:SLOW:DATA"](#) on page 1051
 - [":SEARCh:SERial:SENT:SLOW:ID"](#) on page 1052

:SEARCH:SERIAL:SENT:MODE

N (see [page 1384](#))

Command Syntax :SEARCH:SERIAL:SENT:MODE <mode>

<mode> ::= {FCData | SCMid | SCData | CRCError | PPERror}

When SENT serial decode is turned on and displayed in the Lister, the :SEARCH:SERIAL:SENT:MODE command specifies what to search for in the decoded data:

- FCData – finds Fast Channel data nibbles that match the values entered using additional softkeys.
- SCMid – finds Slow Channel Message IDs that match the value entered using additional softkeys.
- SCData – finds Slow Channel Message IDs and Data that match the values entered using additional softkeys.
- CRCError – finds any CRC error, Fast or Slow.
- PPERror – finds where a nibble is either too wide or too narrow (for example, data nibble < 12 (11.5) or > 27 (27.5) ticks wide). Sync, S&C, data, or checksum pulse periods are checked.

Query Syntax :SEARCH:SERIAL:SENT:MODE?

The :SEARCH:SERIAL:SENT:MODE? query returns the search mode setting.

Return Format <mode><NL>

<mode> ::= {FCD | SCM | SCD | CRC | PPER}

- See Also**
- [":SEARCH:SERIAL:SENT:FAST:DATA"](#) on page 1049
 - [":SEARCH:SERIAL:SENT:SLOW:DATA"](#) on page 1051
 - [":SEARCH:SERIAL:SENT:SLOW:ID"](#) on page 1052

:SEARCh:SERial:SENT:SLOW:DATA

N (see [page 1384](#))

Command Syntax :SEARCh:SERial:SENT:SLOW:DATA <data>

<data> ::= from -1 (don't care) to 65535, in NR1 format.

The :SEARCh:SERial:SENT:SLOW:DATA command specifies the data to search for in the Slow Channel Message ID and Data search mode.

Query Syntax :SEARCh:SERial:SENT:SLOW:DATA?

The :SEARCh:SERial:SENT:SLOW:DATA? query returns the slow channel data search value setting.

Return Format <data><NL>

<data> ::= from -1 (don't care) to 65535, in NR1 format.

- See Also**
- [":SEARCh:SERial:SENT:FAST:DATA"](#) on page 1049
 - [":SEARCh:SERial:SENT:MODE"](#) on page 1050
 - [":SEARCh:SERial:SENT:SLOW:ID"](#) on page 1052

:SEARCh:SERial:SENT:SLOW:ID

N (see [page 1384](#))

Command Syntax :SEARCh:SERial:SENT:SLOW:ID <id>

<id> ::= from -1 (don't care) to 255, in NR1 format.

The :SEARCh:SERial:SENT:SLOW:ID command specifies the ID to search for in the "Slow Channel Message ID" and "Slow Channel Message ID & Data" trigger modes. The ID can be from -1 (don't care) to 255 (depending on the message length).

Query Syntax :SEARCh:SERial:SENT:SLOW:ID?

The :SEARCh:SERial:SENT:SLOW:ID? query returns the slow channel ID search value setting.

Return Format <id><NL>

<id> ::= from -1 (don't care) to 255, in NR1 format.

- See Also**
- [":SEARCh:SERial:SENT:FAST:DATA"](#) on page 1049
 - [":SEARCh:SERial:SENT:MODE"](#) on page 1050
 - [":SEARCh:SERial:SENT:SLOW:DATA"](#) on page 1051

:SEARCh:SERial:SPI Commands

Table 137 :SEARCh:SERial:SPI Commands Summary

Command	Query	Options and Query Returns
:SEARCh:SERial:SPI:MO DE <value> (see page 1054)	:SEARCh:SERial:SPI:MO DE? (see page 1054)	<value> ::= {MOSI MISO}
:SEARCh:SERial:SPI:PA TTern:DATA <string> (see page 1055)	:SEARCh:SERial:SPI:PA TTern:DATA? (see page 1055)	<string> ::= "0xnn...n" where n ::= {0,...,9 A,...,F X}
:SEARCh:SERial:SPI:PA TTern:WIDTh <width> (see page 1056)	:SEARCh:SERial:SPI:PA TTern:WIDTh? (see page 1056)	<width> ::= integer from 1 to 10

:SEARCh:SERial:SPI:MODE

N (see [page 1384](#))

Command Syntax :SEARCh:SERial:SPI:MODE <value>
 <value> ::= {MOSI | MISO}

The :SEARCh:SERial:SPI:MODE command specifies whether the SPI search will be on the MOSI data or the MISO data.

Data values are specified using the :SEARCh:SERial:SPI:PATtern:DATA command.

Query Syntax :SEARCh:SERial:SPI:MODE?

The :SEARCh:SERial:SPI:MODE? query returns the current SPI search mode setting.

Return Format <value><NL>
 <value> ::= {MOSI | MISO}

- See Also**
- [Chapter 30](#), “:SEARCh Commands,” starting on page 969
 - [":SEARCh:SERial:SPI:PATtern:DATA"](#) on page 1055

:SEARCh:SERial:SPI:PATtern:DATA

N (see [page 1384](#))

Command Syntax :SEARCh:SERial:SPI:PATtern:DATA <string>

<string> ::= "0xnn...n" where n ::= {0,...,9 | A,...,F | X}

The :SEARCh:SERial:SPI:PATtern:DATA command specifies the data value when searching for SPI events.

The width of the data value is specified using the :SEARCh:SERial:SPI:PATtern:WIDTh command.

Query Syntax :SEARCh:SERial:SPI:PATtern:DATA?

The :SEARCh:SERial:SPI:PATtern:DATA? query returns the current data value setting.

Return Format <string><NL>

<string> ::= "0xnn...n" where n ::= {0,...,9 | A,...,F | X}

- See Also**
- [Chapter 30](#), “:SEARCh Commands,” starting on page 969
 - [":SEARCh:SERial:SPI:PATtern:WIDTh"](#) on page 1056

:SEARCH:SERIAL:SPI:PATTERN:WIDTH

N (see [page 1384](#))

Command Syntax :SEARCH:SERIAL:SPI:PATTERN:WIDTH <width>
 <width> ::= integer from 1 to 10

The :SEARCH:SERIAL:SPI:PATTERN:WIDTH command specifies the width of the data value (in bytes) when searching for SPI events.

The data value is specified using the :SEARCH:SERIAL:SPI:PATTERN:DATA command.

Query Syntax :SEARCH:SERIAL:SPI:PATTERN:WIDTH?

The :SEARCH:SERIAL:SPI:PATTERN:WIDTH? query returns the current data width setting.

Return Format <width><NL>

<width> ::= integer from 1 to 10

- See Also**
- [Chapter 30](#), “:SEARCH Commands,” starting on page 969
 - [":SEARCH:SERIAL:SPI:PATTERN:DATA"](#) on page 1055

:SEARCh:SERial:UART Commands

Table 138:SEARCh:SERial:UART Commands Summary

Command	Query	Options and Query Returns
:SEARCh:SERial:UART:D ATA <value> (see page 1058)	:SEARCh:SERial:UART:D ATA? (see page 1058)	<value> ::= 8-bit integer from 0-255 (0x00-0xff) in decimal, <hexadecimal>, <binary>, or <quoted_string> format <hexadecimal> ::= #Hnn where n ::= {0,...,9 A,...,F} for hexadecimal <binary> ::= #Bnn...n where n ::= {0 1} for binary <quoted_string> ::= any of the 128 valid 7-bit ASCII characters (or standard abbreviations)
:SEARCh:SERial:UART:M ODE <value> (see page 1059)	:SEARCh:SERial:UART:M ODE? (see page 1059)	<value> ::= {RDATa RD1 RD0 RDX TDATa TD1 TD0 TDX PARityerror AERror}
:SEARCh:SERial:UART:Q UALifier <value> (see page 1060)	:SEARCh:SERial:UART:Q UALifier? (see page 1060)	<value> ::= {EQUal NOTequal GREaterthan LESSthan}

:SEARCH:SERIAL:UART:DATA

N (see [page 1384](#))

Command Syntax :SEARCH:SERIAL:UART:DATA <value>

<value> ::= 8-bit integer from 0-255 (0x00-0xff) in decimal, <hexadecimal>, <binary>, or <quoted_string> format

<hexadecimal> ::= #Hnn where n ::= {0,...,9| A,...,F} for hexadecimal

<binary> ::= #Bnn...n where n ::= {0 | 1} for binary

<quoted_string> ::= any of the 128 valid 7-bit ASCII characters (or standard abbreviations)

The :SEARCH:SERIAL:UART:DATA command specifies a data value when searching for UART/RS232 events.

The data value qualifier is specified using the :SEARCH:SERIAL:UART:QUALifier command.

Query Syntax :SEARCH:SERIAL:UART:DATA?

The :SEARCH:SERIAL:UART:DATA? query returns the current data value setting.

Return Format <value><NL>

<value> ::= 8-bit integer from 0-255 (0x00-0xff) in decimal format

- See Also**
- [Chapter 30](#), “:SEARCH Commands,” starting on page 969
 - [":SEARCH:SERIAL:UART:MODE"](#) on page 1059
 - [":SEARCH:SERIAL:UART:QUALifier"](#) on page 1060

:SEARCh:SERial:UART:MODE

N (see [page 1384](#))

Command Syntax :SEARCh:SERial:UART:MODE <value>

```
<value> ::= {RDATa | RD1 | RD0 | RDX | TDATa | TD1 | TD0 | TDX
             | PARityerror | AERRor}
```

The :SEARCh:SERial:UART:MODE command selects the type of UART/RS232 information to find in the Lister display:

- RDATa – searches for a receive data value when data words are from 5 to 8 bits long.
- RD1 – searches for a receive data value when data words are 9 bits long and the 9th (alert) bit is 1.
- RD0 – searches for a receive data value when data words are 9 bits long and the 9th (alert) bit is 0.
- RDX – searches for a receive data value when data words are 9 bits long and the 9th (alert) bit is a don't care (X).
- TDATa – searches for a transmit data value when data words are from 5 to 8 bits long.
- TD1 – searches for a transmit data value when data words are 9 bits long and the 9th (alert) bit is 1.
- TD0 – searches for a transmit data value when data words are 9 bits long and the 9th (alert) bit is 0.
- TDX – searches for a transmit data value when data words are 9 bits long and the 9th (alert) bit is a don't care (X).
- PARityerror – searches for parity errors.
- AERRor – searches for any error.

Data values are specified using the :SEARCh:SERial:UART:DATA command.

Data value qualifiers are specified using the :SEARCh:SERial:UART:QUALifier command.

Query Syntax :SEARCh:SERial:UART:MODE?

The :SEARCh:SERial:UART:MODE? query returns ...

Return Format <value><NL>

```
<value> ::= {RDAT | RD1 | RD0 | RDX | TDAT | TD1 | TD0 | TDX | PAR
             | AERR}
```

- See Also**
- [Chapter 30](#), “:SEARCh Commands,” starting on page 969
 - [":SEARCh:SERial:UART:DATA"](#) on page 1058
 - [":SEARCh:SERial:UART:QUALifier"](#) on page 1060

:SEARCH:SERIAL:UART:QUALIFIER

N (see [page 1384](#))

Command Syntax :SEARCH:SERIAL:UART:QUALIFIER <value>

<value> ::= {EQUal | NOTequal | GREaterthan | LESSthan}

The :SEARCH:SERIAL:UART:QUALIFIER command specifies the data value qualifier when searching for UART/RS232 events.

Query Syntax :SEARCH:SERIAL:UART:QUALIFIER?

The :SEARCH:SERIAL:UART:QUALIFIER? query returns the current data value qualifier setting.

Return Format <value><NL>

<value> ::= {EQU | NOT | GRE | LESS}

- See Also**
- [Chapter 30](#), “:SEARCH Commands,” starting on page 969
 - [":SEARCH:SERIAL:UART:DATA"](#) on page 1058

31 :SYSTem Commands

Control basic system functions of the oscilloscope. See "[Introduction to :SYSTem Commands](#)" on page 1062.

Table 139: :SYSTem Commands Summary

Command	Query	Options and Query Returns
:SYSTem:DATE <date> (see page 1063)	:SYSTem:DATE? (see page 1063)	<date> ::= <year>,<month>,<day> <year> ::= 4-digit year in NR1 format <month> ::= {1,...,12 JANuary FEBruary MARch APRil MAY JUNE JULy AUGust SEPTember OCTober NOVember DECember} <day> ::= {1,..31}
:SYSTem:DSP <string> (see page 1064)	n/a	<string> ::= up to 75 characters as a quoted ASCII string
n/a	:SYSTem:ERRor? (see page 1065)	<error> ::= an integer error code <error string> ::= quoted ASCII string. See Error Messages (see page 1341).
:SYSTem:LOCK <value> (see page 1066)	:SYSTem:LOCK? (see page 1066)	<value> ::= {{1 ON} {0 OFF}}
:SYSTem:PERSONa[:MANu facturer] <manufacturer_string> (see page 1067)	:SYSTem:PERSONa[:MANu facturer]? (see page 1067)	<manufacturer_string> ::= quoted ASCII string, up to 63 characters
:SYSTem:PERSONa[:MANu facturer]:DEFault (see page 1068)	n/a	Sets manufacturer string to "KEYSIGHT TECHNOLOGIES"
:SYSTem:PRESet (see page 1069)	n/a	See :SYSTem:PRESet (see page 1069)

Table 139 :SYSTem Commands Summary (continued)

Command	Query	Options and Query Returns
:SYSTem:PROTection:LOCK <value> (see page 1072)	:SYSTem:PROTection:LOCK? (see page 1072)	<value> ::= {{1 ON} {0 OFF}}
:SYSTem:RLOGger <setting>[, <file_name>[, <write_mode>]] (see page 1073)	n/a	<setting> ::= {{0 OFF} {1 ON}} <file_name> ::= quoted ASCII string <write_mode> ::= {CREate APPend}
:SYSTem:RLOGger:DESTination <dest> (see page 1074)	:SYSTem:RLOGger:DESTination? (see page 1074)	<dest> ::= {FILE SCReen BOTH}
:SYSTem:RLOGger:DISPlay {{0 OFF} {1 ON}} (see page 1075)	:SYSTem:RLOGger:DISPlay? (see page 1075)	<setting> ::= {0 1}
:SYSTem:RLOGger:FNAME <file_name> (see page 1076)	:SYSTem:RLOGger:FNAME? (see page 1076)	<file_name> ::= quoted ASCII string
:SYSTem:RLOGger:STATE {{0 OFF} {1 ON}} (see page 1077)	:SYSTem:RLOGger:STATE? (see page 1077)	<setting> ::= {0 1}
:SYSTem:RLOGger:TRANSPARENT {{0 OFF} {1 ON}} (see page 1078)	:SYSTem:RLOGger:TRANSPARENT? (see page 1078)	<setting> ::= {0 1}
:SYSTem:RLOGger:WMOde <write_mode> (see page 1079)	:SYSTem:RLOGger:WMOde? (see page 1079)	<write_mode> ::= {CREate APPend}
:SYSTem:SETup <setup_data> (see page 1080)	:SYSTem:SETup? (see page 1080)	<setup_data> ::= data in IEEE 488.2 # format.
:SYSTem:TIME <time> (see page 1082)	:SYSTem:TIME? (see page 1082)	<time> ::= hours, minutes, seconds in NR1 format
:SYSTem:TOUCh {{1 ON} {0 OFF}} (see page 1083)	:SYSTem:TOUCh? (see page 1083)	{1 0}

**Introduction to
:SYSTem
Commands**

SYSTem subsystem commands enable writing messages to the display, setting and reading both the time and the date, querying for errors, and saving and recalling setups.

:SYSTem:DATE

N (see [page 1384](#))

Command Syntax :SYSTem:DATE <date>

<date> ::= <year>, <month>, <day>

<year> ::= 4-digit year in NR1 format

<month> ::= {1, ..., 12 | JANuary | FEBruary | MARCH | APRil | MAY | JUNE
| JULy | AUGust | SEPTember | OCTober | NOVember | DECember}

<day> ::= {1, ..., 31}

The :SYSTem:DATE command sets the date. Validity checking is performed to ensure that the date is valid.

Query Syntax :SYSTem:DATE?

The SYSTem:DATE? query returns the date.

Return Format <year>, <month>, <day><NL>

- See Also**
- ["Introduction to :SYSTem Commands"](#) on page 1062
 - [":SYSTem:TIME"](#) on page 1082

:SYSTem:DSP

N (see [page 1384](#))

Command Syntax :SYSTem:DSP <string>

<string> ::= quoted ASCII string (up to 75 characters)

The :SYSTem:DSP command writes the quoted string (excluding quotation marks) to a text box on-screen.

Use :SYSTem:DSP "" to remotely remove the message from the display. (Two sets of quote marks without a space between them creates a NULL string.)

Press any menu key to manually remove the message from the display.

See Also • ["Introduction to :SYSTem Commands"](#) on page 1062

:SYSTem:ERRor

C (see [page 1384](#))

Query Syntax :SYSTem:ERRor?

The :SYSTem:ERRor? query outputs the next error number and text from the error queue. The instrument has an error queue that is 30 errors deep and operates on a first-in, first-out basis. Repeatedly sending the :SYSTem:ERRor? query returns the errors in the order that they occurred until the queue is empty. Any further queries then return zero until another error occurs.

When remote logging is enabled (using the oscilloscope's front panel), additional debug information can be included in the returned error string. If the error is detected by the SCPI command parser, such as a header error or other syntax error, the extra debug information is generated and included. But if the error is detected by the oscilloscope system, such as when an out-of-range value is sent, then no extra debug information is included.

Return Format

<error number>,<error string><NL>

<error number> ::= an integer error code in NR1 format

<error string> ::= quoted ASCII string containing the error message

Error messages are listed in [Chapter 38](#), "Error Messages," starting on page 1341.

- See Also**
- ["Introduction to :SYSTem Commands"](#) on page 1062
 - ["*ESR \(Standard Event Status Register\)"](#) on page 194
 - ["*CLS \(Clear Status\)"](#) on page 191

:SYSTem:LOCK

N (see [page 1384](#))

Command Syntax :SYSTem:LOCK <on_off>
 <on_off> ::= {{1 | ON} | {0 | OFF}}

The :SYSTem:LOCK command disables the front panel. LOCK ON is the equivalent of sending a local lockout message over the programming interface.

Query Syntax :SYSTem:LOCK?

The :SYSTem:LOCK? query returns the lock status of the front panel.

Return Format <on_off><NL>
 <on_off> ::= {1 | 0}

See Also • ["Introduction to :SYSTem Commands"](#) on page 1062

:SYSTem:PERSONa[:MANufacturer]

N (see [page 1384](#))

Command Syntax :SYSTem:PERSONa[:MANufacturer] <manufacturer_string>
 <manufacturer_string> ::= ::= quoted ASCII string, up to 63 characters

The :SYSTem:PERSONa[:MANufacturer] command lets you change the manufacturer string portion of the identification string returned by the *IDN? query.

The default manufacturer string is "KEYSIGHT TECHNOLOGIES".

If your remote programs depend on a legacy manufacturer string, for example, you could use this command to set the manufacturer string to "AGILENT TECHNOLOGIES".

Query Syntax :SYSTem:PERSONa[:MANufacturer]?

The :SYSTem:PERSONa[:MANufacturer]? query returns the currently set manufacturer string.

Return Format <manufacturer_string><NL>

- See Also**
- ["*IDN \(Identification Number\)"](#) on page 196
 - [":SYSTem:PERSONa\[:MANufacturer\]:DEFault"](#) on page 1068
 - ["Introduction to :SYSTem Commands"](#) on page 1062

:SYSTem:PERSONa[:MANufacturer]:DEFault

N (see [page 1384](#))

Command Syntax :SYSTem:PERSONa[:MANufacturer]:DEFault

The :SYSTem:PERSONa[:MANufacturer]:DEFault command sets the manufacturer string to "KEYSIGHT TECHNOLOGIES".

- See Also**
- ["*IDN \(Identification Number\)"](#) on page 196
 - [":SYSTem:PERSONa\[:MANufacturer\]"](#) on page 1067
 - ["Introduction to :SYSTem Commands"](#) on page 1062

:SYSTEM:PRESet

C (see [page 1384](#))

Command Syntax :SYSTEM:PRESet

The :SYSTEM:PRESet command places the instrument in a known state. This is the same as pressing the **[Default Setup]** key or **[Save/Recall] > Default/Erse > Default Setup** on the front panel.

When you perform a default setup, some user settings (like preferences) remain unchanged. To reset all user settings to their factory defaults, use the *RST command.

Reset conditions are:

Acquire Menu	
Mode	Normal
Averaging	Off
# Averages	8

Analog Channel Menu	
Channel 1	On
Channel 2	Off
Volts/division	5.00 V
Offset	0.00
Coupling	DC
Probe attenuation	10:1
Vernier	Off
Invert	Off
BW limit	Off
Impedance	1 M Ohm (cannot be changed)
Units	Volts
Skew	0

Cursor Menu	
Source	Channel 1

Digital Channel Menu (MSO models only)	
Channel 0 - 7	Off
Labels	Off
Threshold	TTL (1.4 V)

Display Menu	
Persistence	Off
Grid	20%

Quick Meas Menu	
Source	Channel 1

Run Control	
	Scope is running

Time Base Menu	
Main time/division	100 us
Main time base delay	0.00 s
Delay time/division	500 ns
Delay time base delay	0.00 s
Reference	center
Mode	main
Vernier	Off

Trigger Menu	
Type	Edge
Mode	Auto
Coupling	dc
Source	Channel 1
Level	0.0 V
Slope	Positive

Trigger Menu	
HF Reject and noise reject	Off
Holdoff	40 ns
External probe attenuation	10:1
External Units	Volts
External Impedance	1 M Ohm (cannot be changed)

- See Also
- ["Introduction to Common \(*\) Commands"](#) on page 190
 - ["*RST \(Reset\)"](#) on page 202

:SYSTem:PROTection:LOCK

N (see [page 1384](#))

Command Syntax :SYSTem:PROTection:LOCK <on_off>

<on_off> ::= {{1 | ON} | {0 | OFF}}

The :SYSTem:PROTection:LOCK command disables the fifty ohm impedance setting for all analog channels.

Query Syntax :SYSTem:PROTection:LOCK?

The :SYSTem:PROTection:LOCK? query returns the analog channel protection lock status.

Return Format <on_off><NL>

<on_off> ::= {1 | 0}

See Also • ["Introduction to :SYSTem Commands"](#) on page 1062

:SYSTem:RLOGger

N (see [page 1384](#))

Command Syntax :SYSTem:RLOGger <setting>[,<file_name>[,<write_mode>]]
 <setting> ::= {{0 | OFF} | {1 | ON}}
 <file_name> ::= quoted ASCII string
 <write_mode> ::= {CREate | APPend}

The :SYSTem:RLOGger command enables or disables remote command logging, optionally specifying the log file name and write mode.

- See Also**
- [":SYSTem:RLOGger:DESTination"](#) on page 1074
 - [":SYSTem:RLOGger:DISPlay"](#) on page 1075
 - [":SYSTem:RLOGger:FNAME"](#) on page 1076
 - [":SYSTem:RLOGger:STATE"](#) on page 1077
 - [":SYSTem:RLOGger:TRANSPARENT"](#) on page 1078
 - [":SYSTem:RLOGger:WMODE"](#) on page 1079

:SYSTem:RLOGger:DESTination

N (see [page 1384](#))

Command Syntax :SYSTem:RLOGger:DESTination <dest>
<dest> ::= {FILE | SCReen | BOTH}

The :SYSTem:RLOGger:DESTination command specifies whether remote commands are logged to a text file (on a connected USB storage device), logged to the screen, or both.

NOTE

If the destination is changed while remote command logging is running, remote command logging is turned off.

Query Syntax :SYSTem:RLOGger:DESTination?

The :SYSTem:RLOGger:DESTination? query returns the remote command logging destination.

Return Format <dest><NL>
<dest> ::= {FILE | SCR | BOTH}

- See Also**
- [":SYSTem:RLOGger"](#) on page 1073
 - [":SYSTem:RLOGger:DISPlay"](#) on page 1075
 - [":SYSTem:RLOGger:FNAME"](#) on page 1076
 - [":SYSTem:RLOGger:STATE"](#) on page 1077
 - [":SYSTem:RLOGger:TRANSPARENT"](#) on page 1078
 - [":SYSTem:RLOGger:WMODe"](#) on page 1079

:SYSTem:RLOGger:DISPlay

N (see [page 1384](#))

Command Syntax :SYSTem:RLOGger:DISPlay {{0 | OFF} | {1 | ON}}

The :SYSTem:RLOGger:DISPlay command enables or disables the screen display of logged remote commands and their return values (if applicable).

Query Syntax :SYSTem:RLOGger:DISPlay?

The :SYSTem:RLOGger:DISPlay? query returns whether the screen display for remote command logging is enabled or disabled.

Return Format <setting><NL>

<setting> ::= {0 | 1}

- See Also**
- [":SYSTem:RLOGger"](#) on page 1073
 - [":SYSTem:RLOGger:DESTination"](#) on page 1074
 - [":SYSTem:RLOGger:FNAME"](#) on page 1076
 - [":SYSTem:RLOGger:STATE"](#) on page 1077
 - [":SYSTem:RLOGger:TRANSPARENT"](#) on page 1078
 - [":SYSTem:RLOGger:WMODE"](#) on page 1079

:SYSTem:RLOGger:FNAME

N (see [page 1384](#))

Command Syntax :SYSTem:RLOGger:FNAME <file_name>
 <file_name> ::= quoted ASCII string

The :SYSTem:RLOGger:FNAME command specifies the remote command log file name.

Because log files are ASCII text files, the ".txt" extension is automatically added to the name specified.

Query Syntax :SYSTem:RLOGger:FNAME?

The :SYSTem:RLOGger:FNAME? query returns the remote command log file name.

Return Format <file_name><NL>

- See Also**
- [":SYSTem:RLOGger"](#) on page 1073
 - [":SYSTem:RLOGger:DESTination"](#) on page 1074
 - [":SYSTem:RLOGger:DISPlay"](#) on page 1075
 - [":SYSTem:RLOGger:STATe"](#) on page 1077
 - [":SYSTem:RLOGger:TRANSPARENT"](#) on page 1078
 - [":SYSTem:RLOGger:WMODe"](#) on page 1079

:SYSTem:RLOGger:STATe

N (see [page 1384](#))

Command Syntax :SYSTem:RLOGger:STATe {{0 | OFF} | {1 | ON}}

The :SYSTem:RLOGger:STATe command enables or disables remote command logging.

Query Syntax :SYSTem:RLOGger:STATe?

The :SYSTem:RLOGger:STATe? query returns the remote command logging state.

Return Format <setting><NL>

<setting> ::= {0 | 1}

- See Also**
- [":SYSTem:RLOGger"](#) on page 1073
 - [":SYSTem:RLOGger:DESTination"](#) on page 1074
 - [":SYSTem:RLOGger:DISPlay"](#) on page 1075
 - [":SYSTem:RLOGger:FNAME"](#) on page 1076
 - [":SYSTem:RLOGger:TRANSPARENT"](#) on page 1078
 - [":SYSTem:RLOGger:WMODE"](#) on page 1079

:SYSTem:RLOGger:TRANSPARENT

N (see [page 1384](#))

Command Syntax :SYSTem:RLOGger:TRANSPARENT {{0 | OFF} | {1 | ON}}

The :SYSTem:RLOGger:TRANSPARENT command specifies whether the screen display background for remote command logging is transparent or solid.

Query Syntax :SYSTem:RLOGger:TRANSPARENT?

The :SYSTem:RLOGger:TRANSPARENT? query returns the setting for transparent screen display background.

Return Format <setting><NL>
<setting> ::= {0 | 1}

- See Also**
- [":SYSTem:RLOGger"](#) on page 1073
 - [":SYSTem:RLOGger:DESTINATION"](#) on page 1074
 - [":SYSTem:RLOGger:DISPLAY"](#) on page 1075
 - [":SYSTem:RLOGger:FNAME"](#) on page 1076
 - [":SYSTem:RLOGger:STATE"](#) on page 1077
 - [":SYSTem:RLOGger:WMODE"](#) on page 1079

:SYSTem:RLOGger:WMODe

N (see [page 1384](#))

Command Syntax :SYSTem:RLOGger:WMODe <write_mode>
 <write_mode> ::= {CREate | APPend}

The :SYSTem:RLOGger:WMODe command specifies the remote command logging write mode.

Query Syntax :SYSTem:RLOGger:WMODe?

The :SYSTem:RLOGger:WMODe? query returns the remote command logging write mode.

Return Format <write_mode><NL>
 <write_mode> ::= {CRE | APP}

- See Also**
- [":SYSTem:RLOGger"](#) on page 1073
 - [":SYSTem:RLOGger:DESTination"](#) on page 1074
 - [":SYSTem:RLOGger:DISPlay"](#) on page 1075
 - [":SYSTem:RLOGger:FNAME"](#) on page 1076
 - [":SYSTem:RLOGger:STATE"](#) on page 1077
 - [":SYSTem:RLOGger:TRANSPARENT"](#) on page 1078

:SYSTem:SETup

C (see [page 1384](#))

Command Syntax :SYSTem:SETup <setup_data>

<setup_data> ::= binary block data in IEEE 488.2 # format.

The :SYSTem:SETup command sets the oscilloscope as defined by the data in the setup (learn) string sent from the controller. The setup string does not change the interface mode or interface address.

Query Syntax :SYSTem:SETup?

The :SYSTem:SETup? query operates the same as the *LRN? query. It outputs the current oscilloscope setup in the form of a learn string to the controller. The setup (learn) string is sent and received as a binary block of data. The format for the data transmission is the # format defined in the IEEE 488.2 specification.

Return Format <setup_data><NL>

<setup_data> ::= binary block data in IEEE 488.2 # format

- See Also**
- ["Introduction to :SYSTem Commands"](#) on page 1062
 - ["*LRN \(Learn Device Setup\)"](#) on page 197

Example Code

```
' SAVE_SYSTEM_SETUP - The :SYSTEM:SETUP? query returns a program
' message that contains the current state of the instrument. Its
' format is a definite-length binary block, for example,
' #800075595<setup string><NL>
' where the setup string is 75595 bytes in length.
myScope.WriteString ":SYSTEM:SETUP?"
varQueryResult = myScope.ReadIEEEBlock(BinaryType_UI1)
CheckForInstrumentErrors ' After reading query results.

' Output setup string to a file:
Dim strPath As String
strPath = "c:\scope\config\setup.dat"

' Open file for output.
Close #1 ' If #1 is open, close it.
Open strPath For Binary Access Write Lock Write As #1
Put #1, , varQueryResult ' Write data.
Close #1 ' Close file.

' RESTORE_SYSTEM_SETUP - Read the setup string from a file and
' write it back to the oscilloscope.
Dim varSetupString As Variant
strPath = "c:\scope\config\setup.dat"

' Open file for input.
Open strPath For Binary Access Read As #1
Get #1, , varSetupString ' Read data.
Close #1 ' Close file.

' Write setup string back to oscilloscope using ":SYSTEM:SETUP"
```



```
' command:  
myScope.WriteIEEEBlock ":SYSTEM:SETUP ", varSetupString  
CheckForInstrumentErrors
```

See complete example programs at: [Chapter 42](#), “Programming Examples,” starting on page 1393

:SYSTem:TIME

N (see [page 1384](#))

Command Syntax :SYSTem:TIME <time>

<time> ::= hours,minutes,seconds in NR1 format

The :SYSTem:TIME command sets the system time, using a 24-hour format. Commas are used as separators. Validity checking is performed to ensure that the time is valid.

Query Syntax :SYSTem:TIME? <time>

The :SYSTem:TIME? query returns the current system time.

Return Format <time><NL>

<time> ::= hours,minutes,seconds in NR1 format

- See Also**
- ["Introduction to :SYSTem Commands"](#) on page 1062
 - [":SYSTem:DATE"](#) on page 1063

:SYSTem:TOUCh

N (see [page 1384](#))

Command Syntax :SYSTem:TOUCh <on_off>
<on_off> ::= {{1 | ON} | {0 | OFF}}

The :SYSTem:TOUCh command disables or enables the touchscreen.

Query Syntax :SYSTem:TOUCh?

The :SYSTem:TOUCh? query returns the touchscreen's on/off status.

Return Format <on_off><NL>
<on_off> ::= {1 | 0}

See Also · ["Introduction to :SYSTem Commands"](#) on page 1062

32 :TIMebase Commands

Control all horizontal sweep functions. See "[Introduction to :TIMebase Commands](#)" on page 1086.

Table 140: TIMebase Commands Summary

Command	Query	Options and Query Returns
:TIMebase:MODE <value> (see page 1087)	:TIMebase:MODE? (see page 1087)	<value> ::= {MAIN WINDow XY ROLL}
:TIMebase:POSition <pos> (see page 1088)	:TIMebase:POSition? (see page 1088)	<pos> ::= time from the trigger event to the display reference point in NR3 format
:TIMebase:RANGE <range_value> (see page 1089)	:TIMebase:RANGE? (see page 1089)	<range_value> ::= time for 10 div in seconds in NR3 format
:TIMebase:REFerence {LEFT CENTER RIGHT CUSTom} (see page 1090)	:TIMebase:REFerence? (see page 1090)	<return_value> ::= {LEFT CENTER RIGHT CUSTom}
:TIMebase:REFerence:LOCation <loc> (see page 1091)	:TIMebase:REFerence:LOCation? (see page 1091)	<loc> ::= 0.0 to 1.0 in NR3 format
:TIMebase:SCALE <scale_value> (see page 1092)	:TIMebase:SCALE? (see page 1092)	<scale_value> ::= time/div in seconds in NR3 format
:TIMebase:VERNier {{0 OFF} {1 ON}} (see page 1093)	:TIMebase:VERNier? (see page 1093)	{0 1}
:TIMebase:WINDow:POSition <pos> (see page 1094)	:TIMebase:WINDow:POSition? (see page 1094)	<pos> ::= time from the trigger event to the zoomed view reference point in NR3 format

Table 140: TIMebase Commands Summary (continued)

Command	Query	Options and Query Returns
:TIMebase:WINDow:RANGe <range_value> (see page 1095)	:TIMebase:WINDow:RANGe? (see page 1095)	<range_value> ::= range value in seconds in NR3 format for the zoomed window
:TIMebase:WINDow:SCALe <scale_value> (see page 1096)	:TIMebase:WINDow:SCALe? (see page 1096)	<scale_value> ::= scale value in seconds in NR3 format for the zoomed window

Introduction to :TIMebase Commands The TIMebase subsystem commands control the horizontal (X-axis) functions and set the oscilloscope to X-Y mode (where channel 1 becomes the X input and channel 2 becomes the Y input). The time per division, delay, vernier control, and reference can be controlled for the main and window (zoomed) time bases.

Reporting the Setup

Use :TIMebase? to query setup information for the TIMebase subsystem.

Return Format

The following is a sample response from the :TIMebase? query. In this case, the query was issued following a *RST command.

```
:TIM:MODE MAIN;REF CENT;MAIN:RANG +1.00E-03;POS +0.0E+00
```

:TIMEbase:MODE

C (see [page 1384](#))

Command Syntax :TIMEbase:MODE <value>

<value> ::= {MAIN | WINDow | XY | ROLL}

The :TIMEbase:MODE command sets the current time base. There are four time base modes:

- MAIN – The normal time base mode is the main time base. It is the default time base mode after the *RST (Reset) command.
- WINDow – In the WINDow (zoomed or delayed) time base mode, measurements are made in the zoomed time base if possible; otherwise, the measurements are made in the main time base.
- XY – In the XY mode, the :TIMEbase:RANGe, :TIMEbase:POSition, and :TIMEbase:REFerence commands are not available. No measurements are available in this mode.
- ROLL – In the ROLL mode, data moves continuously across the display from left to right. The oscilloscope runs continuously and is untriggered. The :TIMEbase:REFerence selection changes to RIGHT.

Query Syntax :TIMEbase:MODE?

The :TIMEbase:MODE query returns the current time base mode.

Return Format <value><NL>

<value> ::= {MAIN | WIND | XY | ROLL}

- See Also**
- ["Introduction to :TIMEbase Commands"](#) on page 1086
 - ["*RST \(Reset\)"](#) on page 202
 - [":TIMEbase:RANGe"](#) on page 1089
 - [":TIMEbase:POSition"](#) on page 1088
 - [":TIMEbase:REFerence"](#) on page 1090

Example Code

```
' TIMEBASE_MODE - (not executed in this example)
' Set the time base mode to MAIN, DELAYED, XY, or ROLL.

' Set time base mode to main.
myScope.WriteString ":TIMEBASE:MODE MAIN"
```

See complete example programs at: [Chapter 42](#), "Programming Examples," starting on page 1393

:TIMebase:POSition

C (see [page 1384](#))

Command Syntax :TIMebase:POSition <pos>

<pos> ::= time in seconds from the trigger to the display reference
in NR3 format

The :TIMebase:POSition command sets the time interval between the trigger event and the display reference point on the screen. The display reference point is either left, right, or center and is set with the :TIMebase:REFerence command. The maximum position value depends on the time/division settings.

NOTE

This command is an alias for the :TIMebase:DELay command.

Query Syntax :TIMebase:POSition?

The :TIMebase:POSition? query returns the current time from the trigger to the display reference in seconds.

Return Format <pos><NL>

<pos> ::= time in seconds from the trigger to the display reference
in NR3 format

- See Also**
- ["Introduction to :TIMebase Commands"](#) on page 1086
 - [":TIMebase:REFerence"](#) on page 1090
 - [":TIMebase:RANGe"](#) on page 1089
 - [":TIMebase:SCALE"](#) on page 1092
 - [":TIMebase:WINDow:POSition"](#) on page 1094
 - [":TIMebase:DELay"](#) on page 1337

:TIMEbase:RANGe

C (see [page 1384](#))

Command Syntax :TIMEbase:RANGe <range_value>

<range_value> ::= time for 10 div in seconds in NR3 format

The :TIMEbase:RANGe command sets the full-scale horizontal time in seconds for the main window. The range is 10 times the current time-per-division setting.

Query Syntax :TIMEbase:RANGe?

The :TIMEbase:RANGe query returns the current full-scale range value for the main window.

Return Format <range_value><NL>

<range_value> ::= time for 10 div in seconds in NR3 format

- See Also**
- ["Introduction to :TIMEbase Commands"](#) on page 1086
 - [":TIMEbase:MODE"](#) on page 1087
 - [":TIMEbase:SCALE"](#) on page 1092
 - [":TIMEbase:WINDow:RANGe"](#) on page 1095

Example Code

```
' TIME_RANGE - Sets the full scale horizontal time in seconds. The
' range value is 10 times the time per division.
myScope.WriteString ":TIM:RANG 2e-3" ' Set the time range to 0.002
seconds.
```

See complete example programs at: [Chapter 42](#), "Programming Examples," starting on page 1393

:TIMebase:REFeRence

C (see [page 1384](#))

Command Syntax :TIMebase:REFeRence <reference>

<reference> ::= {LEFT | CENTer | RIGHT | CUSTom}

The :TIMebase:REFeRence command sets the time reference to:

- LEFT – one division from the left side of the screen.
- CENTer – the center of the screen.
- RIGHT – one division from the right side of the screen.
- CUSTom – lets you use the :TIMebase:REFeRence:LOCation command to place the time reference location at a percent of the graticule width (where 0.0 is the left edge and 1.0 is the right edge).

The time reference is the point on the display where the trigger point is referenced.

Query Syntax :TIMebase:REFeRence?

The :TIMebase:REFeRence? query returns the current display reference for the main window.

Return Format <reference><NL>

<reference> ::= {LEFT | CENT | RIGH | CUST}

- See Also**
- ["Introduction to :TIMebase Commands"](#) on page 1086
 - [":TIMebase:REFeRence:LOCation"](#) on page 1091
 - [":TIMebase:MODE"](#) on page 1087

Example Code

```
myScope.WriteString ":TIMebase:REFeRence CENTer" ' Set reference to center.
```

See complete example programs at: [Chapter 42](#), "Programming Examples," starting on page 1393

:TIMebase:REFerence:LOCation

N (see [page 1384](#))

Command Syntax :TIMebase:REFerence:LOCation <loc>
 <loc> ::= 0.0 to 1.0 in NR3 format

When the :TIMebase:REFerence is set to CUSTom, the :TIMebase:REFerence:LOCation command lets you place the time reference location at a percent of the graticule width (where 0.0 is the left edge and 1.0 is the right edge).

Query Syntax :TIMebase:REFerence:LOCation?

The :TIMebase:REFerence:LOCation? query returns the time base reference custom location setting.

Return Format <loc><NL>
 <loc> ::= 0.0 to 1.0 in NR3 format

See Also • [":TIMebase:REFerence"](#) on page 1090

:TIMEbase:SCALE

N (see [page 1384](#))

Command Syntax :TIMEbase:SCALE <scale_value>

<scale_value> ::= time/div in seconds in NR3 format

The :TIMEbase:SCALE command sets the horizontal scale or units per division for the main window.

Query Syntax :TIMEbase:SCALE?

The :TIMEbase:SCALE? query returns the current horizontal scale setting in seconds per division for the main window.

Return Format <scale_value><NL>

<scale_value> ::= time/div in seconds in NR3 format

- See Also**
- ["Introduction to :TIMEbase Commands"](#) on page 1086
 - [":TIMEbase:RANGe"](#) on page 1089
 - [":TIMEbase:WINDow:SCALE"](#) on page 1096
 - [":TIMEbase:WINDow:RANGe"](#) on page 1095

:TIMEbase:VERNier

N (see [page 1384](#))

Command Syntax :TIMEbase:VERNier <vernier value>

<vernier value> ::= {{1 | ON} | {0 | OFF}}

The :TIMEbase:VERNier command specifies whether the time base control's vernier (fine horizontal adjustment) setting is ON (1) or OFF (0).

Query Syntax :TIMEbase:VERNier?

The :TIMEbase:VERNier? query returns the current state of the time base control's vernier setting.

Return Format <vernier value><NL>

<vernier value> ::= {0 | 1}

See Also • ["Introduction to :TIMEbase Commands"](#) on page 1086

:TIMEbase:WINDow:POSition

C (see [page 1384](#))

Command Syntax :TIMEbase:WINDow:POSition <pos value>

<pos value> ::= time from the trigger event to the zoomed (delayed) view reference point in NR3 format

The :TIMEbase:WINDow:POSition command sets the horizontal position in the zoomed (delayed) view of the main sweep. The main sweep range and the main sweep horizontal position determine the range for this command. The value for this command must keep the zoomed view window within the main sweep range.

Query Syntax :TIMEbase:WINDow:POSition?

The :TIMEbase:WINDow:POSition? query returns the current horizontal window position setting in the zoomed view.

Return Format <value><NL>

<value> ::= position value in seconds

- See Also**
- ["Introduction to :TIMEbase Commands"](#) on page 1086
 - [":TIMEbase:MODE"](#) on page 1087
 - [":TIMEbase:POSition"](#) on page 1088
 - [":TIMEbase:RANGe"](#) on page 1089
 - [":TIMEbase:SCALe"](#) on page 1092
 - [":TIMEbase:WINDow:RANGe"](#) on page 1095
 - [":TIMEbase:WINDow:SCALe"](#) on page 1096

:TIMEbase:WINDow:RANGe

C (see [page 1384](#))

Command Syntax :TIMEbase:WINDow:RANGe <range value>

<range value> ::= range value in seconds in NR3 format

The :TIMEbase:WINDow:RANGe command sets the full-scale horizontal time in seconds for the zoomed (delayed) window. The range is 10 times the current zoomed view window seconds per division setting. The main sweep range determines the range for this command. The maximum value is one half of the :TIMEbase:RANGe value.

Query Syntax :TIMEbase:WINDow:RANGe?

The :TIMEbase:WINDow:RANGe? query returns the current window timebase range setting.

Return Format <value><NL>

<value> ::= range value in seconds

- See Also**
- ["Introduction to :TIMEbase Commands"](#) on page 1086
 - [":TIMEbase:RANGe"](#) on page 1089
 - [":TIMEbase:POSition"](#) on page 1088
 - [":TIMEbase:SCALe"](#) on page 1092

:TIMEbase:WINDow:SCALE

N (see [page 1384](#))

Command Syntax :TIMEbase:WINDow:SCALE <scale_value>

<scale_value> ::= scale value in seconds in NR3 format

The :TIMEbase:WINDow:SCALE command sets the zoomed (delayed) window horizontal scale (seconds/division). The main sweep scale determines the range for this command. The maximum value is one half of the :TIMEbase:SCALE value.

Query Syntax :TIMEbase:WINDow:SCALE?

The :TIMEbase:WINDow:SCALE? query returns the current zoomed window scale setting.

Return Format <scale_value><NL>

<scale_value> ::= current seconds per division for the zoomed window

- See Also**
- ["Introduction to :TIMEbase Commands"](#) on page 1086
 - [":TIMEbase:RANGe"](#) on page 1089
 - [":TIMEbase:POSition"](#) on page 1088
 - [":TIMEbase:SCALE"](#) on page 1092
 - [":TIMEbase:WINDow:RANGe"](#) on page 1095

33 :TRIGger Commands

Control the trigger modes and parameters for each trigger type. See:

- "[Introduction to :TRIGger Commands](#)" on page 1097
- "[General :TRIGger Commands](#)" on page 1099
- "[:TRIGger:DELAy Commands](#)" on page 1109
- "[:TRIGger:EBURst Commands](#)" on page 1116
- "[:TRIGger\[:EDGE\] Commands](#)" on page 1121
- "[:TRIGger:GLITCh Commands](#)" on page 1127 (Pulse Width trigger)
- "[:TRIGger:NFC Commands](#)" on page 1136
- "[:TRIGger:OR Commands](#)" on page 1146
- "[:TRIGger:PATTern Commands](#)" on page 1148
- "[:TRIGger:RUNT Commands](#)" on page 1156
- "[:TRIGger:SHOLd Commands](#)" on page 1161
- "[:TRIGger:TRANSition Commands](#)" on page 1167
- "[:TRIGger:TV Commands](#)" on page 1172
- "[:TRIGger:USB Commands](#)" on page 1182
- "[:TRIGger:ZONE Commands](#)" on page 1187

Introduction to :TRIGger Commands

The commands in the TRIGger subsystem define the conditions for an internal trigger. Many of these commands are valid in multiple trigger modes.

The default trigger mode is :EDGE.

The trigger subsystem controls the trigger sweep mode and the trigger specification. The trigger sweep (see "[:TRIGger:SWEep](#)" on page 1108) can be AUTO or NORMAl.

- **NORMAl** mode – displays a waveform only if a trigger signal is present and the trigger conditions are met. Otherwise the oscilloscope does not trigger and the display is not updated. This mode is useful for low-repetitive-rate signals.
- **AUTO** trigger mode – generates an artificial trigger event if the trigger specification is not satisfied within a preset time, acquires unsynchronized data and displays it.

AUTO mode is useful for signals other than low-repetitive-rate signals. You must use this mode to display a DC signal because there are no edges on which to trigger.

The following trigger types are available (see "**:TRIGger:MODE**" on page 1106).

- **Edge triggering**— identifies a trigger by looking for a specified slope and voltage level on a waveform.
- **Nth Edge Burst triggering**— lets you trigger on the Nth edge of a burst that occurs after an idle time.
- **Pulse width triggering**— (:TRIGger:GLITCh commands) sets the oscilloscope to trigger on a positive pulse or on a negative pulse of a specified width.
- **Pattern triggering**— identifies a trigger condition by looking for a specified pattern. This pattern is a logical AND combination of the channels. You can also trigger on a specified time duration of a pattern.
- **TV triggering**— is used to capture the complicated waveforms of television equipment. The trigger circuitry detects the vertical and horizontal interval of the waveform and produces triggers based on the TV trigger settings you selected. TV triggering requires greater than ¼ division of sync amplitude with any analog channel as the trigger source.
- **USB (Universal Serial Bus) triggering**— will trigger on a Start of Packet (SOP), End of Packet (EOP), Reset Complete, Enter Suspend, or Exit Suspend signal on the differential USB data lines. USB Low Speed and Full Speed are supported by this trigger.

Reporting the Setup

Use :TRIGger? to query setup information for the TRIGger subsystem.

Return Format

The return format for the TRIGger? query varies depending on the current mode. The following is a sample response from the :TRIGger? query. In this case, the query was issued following a *RST command.

```
:TRIG:MODE EDGE;SWE AUTO;NREJ 0;HFR 0;HOLD +60.000000000000E-09;
:TRIG:EDGE:SOUR CHAN1;LEV +0.00000E+00;SLOP POS;REJ OFF;COUP DC;
:TRIG:ZONE:STAT 0
```

General :TRIGger Commands

Table 141 General :TRIGger Commands Summary

Command	Query	Options and Query Returns
:TRIGger:FORCe (see page 1100)	n/a	n/a
:TRIGger:HFReject {{0 OFF} {1 ON}} (see page 1101)	:TRIGger:HFReject? (see page 1101)	{0 1}
:TRIGger:HOLDoFF <holdoff_time> (see page 1102)	:TRIGger:HOLDoFF? (see page 1102)	<holdoff_time> ::= 60 ns to 10 s in NR3 format
:TRIGger:LEVel:ASEtUp (see page 1103)	n/a	n/a
:TRIGger:LEVel:HIGH <level>, <source> (see page 1104)	:TRIGger:LEVel:HIGH? <source> (see page 1104)	<level> ::= .75 x full-scale voltage from center screen in NR3 format. <source> ::= CHANnel<n> <n> ::= 1 to (# analog channels) in NR1 format
:TRIGger:LEVel:LOW <level>, <source> (see page 1105)	:TRIGger:LEVel:LOW? <source> (see page 1105)	<level> ::= .75 x full-scale voltage from center screen in NR3 format. <source> ::= CHANnel<n> <n> ::= 1 to (# analog channels) in NR1 format
:TRIGger:MODE <mode> (see page 1106)	:TRIGger:MODE? (see page 1106)	<mode> ::= {EDGE GLITCh PATtern TV DELay EBURst OR RUNT SHOLd TRANsition SBUS{1 2}} <return_value> ::= {<mode> <none>} <none> ::= query returns "NONE" if the :TIMEbase:MODE is ROLL or XY
:TRIGger:NREJect {{0 OFF} {1 ON}} (see page 1107)	:TRIGger:NREJect? (see page 1107)	{0 1}
:TRIGger:SWEep <sweep> (see page 1108)	:TRIGger:SWEep? (see page 1108)	<sweep> ::= {AUTO NORMal}

:TRIGger:FORCe

N (see [page 1384](#))

Command Syntax :TRIGger:FORCe

The :TRIGger:FORCe command causes an acquisition to be captured even though the trigger condition has not been met. This command is equivalent to the front panel **[Force Trigger]** key.

See Also • ["Introduction to :TRIGger Commands"](#) on page 1097

:TRIGger:HFReject

C (see [page 1384](#))

Command Syntax :TRIGger:HFReject <value>
<value> ::= {{0 | OFF} | {1 | ON}}

The :TRIGger:HFReject command turns the high frequency reject filter off and on. The high frequency reject filter adds a 50 kHz low-pass filter in the trigger path to remove high frequency components from the trigger waveform. Use this filter to remove high-frequency noise, such as AM or FM broadcast stations, from the trigger path.

Query Syntax :TRIGger:HFReject?

The :TRIGger:HFReject? query returns the current high frequency reject filter mode.

Return Format <value><NL>
<value> ::= {0 | 1}

- See Also**
- ["Introduction to :TRIGger Commands"](#) on page 1097
 - [":TRIGger\[:EDGE\]:REJect"](#) on page 1124

:TRIGger:HOLDoff

C (see [page 1384](#))

Command Syntax :TRIGger:HOLDoff <holdoff_time>
 <holdoff_time> ::= 40 ns to 10 s in NR3 format

The :TRIGger:HOLDoff command defines the holdoff time value in seconds. Holdoff keeps a trigger from occurring until after a certain amount of time has passed since the last trigger. This feature is valuable when a waveform crosses the trigger level multiple times during one period of the waveform. Without holdoff, the oscilloscope could trigger on each of the crossings, producing a confusing waveform. With holdoff set correctly, the oscilloscope always triggers on the same crossing. The correct holdoff setting is typically slightly less than one period.

Query Syntax :TRIGger:HOLDoff?

The :TRIGger:HOLDoff? query returns the holdoff time value for the current trigger mode.

Return Format <holdoff_time><NL>
 <holdoff_time> ::= the holdoff time value in seconds in NR3 format.

See Also • ["Introduction to :TRIGger Commands"](#) on page 1097

:TRIGger:LEVel:ASETup

N (see [page 1384](#))

Command Syntax :TRIGger:LEVel:ASETup

The :TRIGger:LEVel:ASETup command automatically sets the trigger levels of all displayed analog channels to their waveforms' 50% values.

If AC coupling is used, the trigger levels are set to 0 V.

When High and Low (dual) trigger levels are used (as with Rise/Fall Time and Runt triggers, for example), this command has no effect.

See Also • [":TRIGger\[:EDGE\]:LEVel"](#) on page 1123

:TRIGger:LEVel:HIGH

N (see [page 1384](#))

Command Syntax :TRIGger:LEVel:HIGH <level>, <source>

<level> ::= 0.75 x full-scale voltage from center screen in NR3 format
for internal triggers

<source> ::= CHANnel<n>

<n> ::= 1 to (# analog channels) in NR1 format

The :TRIGger:LEVel:HIGH command sets the high trigger voltage level voltage for the specified source.

High and low trigger levels are used with runt triggers and rise/fall time (transition) triggers.

Query Syntax :TRIGger:LEVel:HIGH? <source>

The :TRIGger:LEVel:HIGH? query returns the high trigger voltage level for the specified source.

Return Format <level><NL>

- See Also**
- ["Introduction to :TRIGger Commands"](#) on page 1097
 - [":TRIGger:LEVel:LOW"](#) on page 1105
 - [":TRIGger:RUNT Commands"](#) on page 1156
 - [":TRIGger:TRANSition Commands"](#) on page 1167
 - [":TRIGger\[:EDGE\]:SOURce"](#) on page 1126

:TRIGger:LEVel:LOW

N (see [page 1384](#))

Command Syntax :TRIGger:LEVel:LOW <level>, <source>

<level> ::= 0.75 x full-scale voltage from center screen in NR3 format
for internal triggers

<source> ::= CHANnel<n>

<n> ::= 1 to (# analog channels) in NR1 format

The :TRIGger:LEVel:LOW command sets the low trigger voltage level voltage for the specified source.

High and low trigger levels are used with runt triggers and rise/fall time (transition) triggers.

Query Syntax :TRIGger:LEVel:LOW? <source>

The :TRIGger:LEVel:LOW? query returns the low trigger voltage level for the specified source.

Return Format <level><NL>

- See Also**
- ["Introduction to :TRIGger Commands"](#) on page 1097
 - [":TRIGger:LEVel:HIGH"](#) on page 1104
 - [":TRIGger:RUNT Commands"](#) on page 1156
 - [":TRIGger:TRANSition Commands"](#) on page 1167
 - [":TRIGger\[:EDGE\]:SOURce"](#) on page 1126

:TRIGger:MODE

C (see [page 1384](#))

Command Syntax :TRIGger:MODE <mode>

```
<mode> ::= {EDGE | GLITch | PATTern | TV | DELay | EBURst | OR | RUNT  
           | SHOLd | TRANsition | SBUS{1 | 2} | NFC | USB}
```

The :TRIGger:MODE command selects the trigger mode (trigger type).

Query Syntax :TRIGger:MODE?

The :TRIGger:MODE? query returns the current trigger mode. If the :TIMebase:MODE is ROLL or XY, the query returns "NONE".

Return Format <mode><NL>

```
<mode> ::= {EDGE | GLIT | PATT | TV | DEL | EBUR | OR | RUNT | SHOL  
           | TRAN | SBUS{1 | 2} | NFC | USB}
```

- See Also**
- ["Introduction to :TRIGger Commands"](#) on page 1097
 - [":TRIGger:SWEep"](#) on page 1108
 - [":TIMebase:MODE"](#) on page 1087

Example Code

```
' TRIGGER_MODE - Set the trigger mode to EDGE.  
myScope.WriteString ":TRIGger:MODE EDGE"
```

See complete example programs at: [Chapter 42](#), "Programming Examples," starting on page 1393

:TRIGger:NREJect

C (see [page 1384](#))

Command Syntax :TRIGger:NREJect <value>

<value> ::= {{0 | OFF} | {1 | ON}}

The :TRIGger:NREJect command turns the noise reject filter off and on. When the noise reject filter is on, the trigger circuitry is less sensitive to noise but may require a greater amplitude waveform to trigger the oscilloscope. This command is not valid in TV trigger mode.

Query Syntax :TRIGger:NREJect?

The :TRIGger:NREJect? query returns the current noise reject filter mode.

Return Format <value><NL>

<value> ::= {0 | 1}

See Also • ["Introduction to :TRIGger Commands"](#) on page 1097

:TRIGger:SWEEp

C (see [page 1384](#))

Command Syntax :TRIGger:SWEEp <sweep>
<sweep> ::= {AUTO | NORMAl}

The :TRIGger:SWEEp command selects the trigger sweep mode.

When AUTO sweep mode is selected, a baseline is displayed in the absence of a signal. If a signal is present but the oscilloscope is not triggered, the unsynchronized signal is displayed instead of a baseline.

When NORMAl sweep mode is selected and no trigger is present, the instrument does not sweep, and the data acquired on the previous trigger remains on the screen.

NOTE

This feature is called "Mode" on the instrument's front panel.

Query Syntax :TRIGger:SWEEp?

The :TRIGger:SWEEp? query returns the current trigger sweep mode.

Return Format <sweep><NL>
<sweep> ::= current trigger sweep mode

See Also • ["Introduction to :TRIGger Commands"](#) on page 1097

:TRIGger:DELAy Commands

Table 142: :TRIGger:DELAy Commands Summary

Command	Query	Options and Query Returns
:TRIGger:DELAy:ARM:SL OPe <slope> (see page 1110)	:TRIGger:DELAy:ARM:SL OPe? (see page 1110)	<slope> ::= {NEGative POSitive}
:TRIGger:DELAy:ARM:SO URce <source> (see page 1111)	:TRIGger:DELAy:ARM:SO URce? (see page 1111)	<source> ::= {CHANnel<n> DIGital<d>} <n> ::= 1 to (# analog channels) in NR1 format <d> ::= 0 to (# digital channels - 1) in NR1 format
:TRIGger:DELAy:TDELAy :TIME <time_value> (see page 1112)	:TRIGger:DELAy:TDELAy :TIME? (see page 1112)	<time_value> ::= time in seconds in NR3 format
:TRIGger:DELAy:TRIGge r:COUNT <count> (see page 1113)	:TRIGger:DELAy:TRIGge r:COUNT? (see page 1113)	<count> ::= integer in NR1 format
:TRIGger:DELAy:TRIGge r:SLOPe <slope> (see page 1114)	:TRIGger:DELAy:TRIGge r:SLOPe? (see page 1114)	<slope> ::= {NEGative POSitive}
:TRIGger:DELAy:TRIGge r:SOURce <source> (see page 1115)	:TRIGger:DELAy:TRIGge r:SOURce? (see page 1115)	<source> ::= {CHANnel<n> DIGital<d>} <n> ::= 1 to (# analog channels) in NR1 format <d> ::= 0 to (# digital channels - 1) in NR1 format

The :TRIGger:DELAy:ARM:SOURce and :TRIGger:DELAy:TRIGger:SOURce commands are used to specify the source channel for the arming edge and the trigger edge in the Edge Then Edge trigger.

If an analog channel is selected as a source, the :TRIGger:EDGE:LEVel command is used to set the trigger level.

If a digital channel is selected as the source, the :DIGital<n>:THReshold or :POD<n>:THReshold command is used to set the trigger level.

:TRIGger:DElay:ARM:SLOPe

N (see [page 1384](#))

Command Syntax :TRIGger:DElay:ARM:SLOPe <slope>
 <slope> ::= {NEGative | POSitive}

The :TRIGger:DElay:ARM:SLOPe command specifies rising (POSitive) or falling (NEGative) for the arming edge in the Edge Then Edge trigger.

Query Syntax :TRIGger:DElay:ARM:SLOPe?

The :TRIGger:DElay:ARM:SLOPe? query returns the current arming edge slope setting.

Return Format <slope><NL>
 <slope> ::= {NEG | POS}

- See Also**
- ["Introduction to :TRIGger Commands"](#) on page 1097
 - [":TRIGger:DElay:ARM:SOURce"](#) on page 1111
 - [":TRIGger:DElay:TDElay:TIME"](#) on page 1112

:TRIGger:DElay:ARM:SOURce

N (see [page 1384](#))

Command Syntax :TRIGger:DElay:ARM:SOURce <source>

<source> ::= {CHANnel<n> | DIGital<d>}

<n> ::= 1 to (# analog channels) in NR1 format

<d> ::= 0 to (# digital channels - 1) in NR1 format

The :TRIGger:DElay:ARM:SOURce command selects the input used for the arming edge in the Edge Then Edge trigger.

Query Syntax :TRIGger:DElay:ARM:SOURce?

The :TRIGger:DElay:ARM:SOURce? query returns the current arming edge source.

Return Format <source><NL>

<source> ::= {CHAN<n> | DIG<d>}

- See Also**
- ["Introduction to :TRIGger Commands"](#) on page 1097
 - [":TRIGger:DElay:ARM:SLOPe"](#) on page 1110
 - [":TRIGger:DElay:TDElay:TIME"](#) on page 1112
 - [":TRIGger:MODE"](#) on page 1106

:TRIGger:DElay:TDElay:TIME

N (see [page 1384](#))

Command Syntax :TRIGger:DElay:TDElay:TIME <time_value>

<time_value> ::= time in seconds in NR3 format

The :TRIGger:DElay:TDElay:TIME command sets the delay time between the arming edge and the trigger edge in the Edge Then Edge trigger. The time is in seconds and must be from 4 ns to 10 s.

Query Syntax :TRIGger:DElay:TDElay:TIME?

The :TRIGger:DElay:TDElay:TIME? query returns current delay time setting.

Return Format <time_value><NL>

<time_value> ::= time in seconds in NR3 format

- See Also**
- ["Introduction to :TRIGger Commands"](#) on page 1097
 - [":TRIGger:DElay:TRIGger:SLOPe"](#) on page 1114
 - [":TRIGger:DElay:TRIGger:COUNt"](#) on page 1113

:TRIGger:DElay:TRIGger:COUNT

N (see [page 1384](#))

Command Syntax :TRIGger:DElay:TRIGger:COUNT <count>
 <count> ::= integer in NR1 format

The :TRIGger:DElay:TRIGger:COUNT command sets the Nth edge of the trigger source to trigger on.

Query Syntax :TRIGger:DElay:TRIGger:COUNT?

The :TRIGger:DElay:TRIGger:COUNT? query returns the current Nth trigger edge setting.

Return Format <count><NL>
 <count> ::= integer in NR1 format

- See Also**
- ["Introduction to :TRIGger Commands"](#) on page 1097
 - [":TRIGger:DElay:TRIGger:SLOPe"](#) on page 1114
 - [":TRIGger:DElay:TRIGger:SOURce"](#) on page 1115
 - [":TRIGger:DElay:TDElay:TIME"](#) on page 1112

:TRIGger:DElay:TRIGger:SLOPe

N (see [page 1384](#))

Command Syntax :TRIGger:DElay:TRIGger:SLOPe <slope>
 <slope> ::= {NEGative | POSitive}

The :TRIGger:DElay:TRIGger:SLOPe command specifies rising (POSitive) or falling (NEGative) for the trigger edge in the Edge Then Edge trigger.

Query Syntax :TRIGger:DElay:TRIGger:SLOPe?

The :TRIGger:DElay:TRIGger:SLOPe? query returns the current trigger edge slope setting.

Return Format <slope><NL>
 <slope> ::= {NEG | POS}

- See Also**
- ["Introduction to :TRIGger Commands"](#) on page 1097
 - [":TRIGger:DElay:TRIGger:SOURce"](#) on page 1115
 - [":TRIGger:DElay:TDElay:TIME"](#) on page 1112
 - [":TRIGger:DElay:TRIGger:COUNt"](#) on page 1113

:TRIGger:DElay:TRIGger:SOURce

N (see [page 1384](#))

Command Syntax :TRIGger:DElay:TRIGger:SOURce <source>

<source> ::= {CHANnel<n> | DIGital<d>}

<n> ::= 1 to (# analog channels) in NR1 format

<d> ::= 0 to (# digital channels - 1) in NR1 format

The :TRIGger:DElay:TRIGger:SOURce command selects the input used for the trigger edge in the Edge Then Edge trigger.

Query Syntax :TRIGger:DElay:TRIGger:SOURce?

The :TRIGger:DElay:TRIGger:SOURce? query returns the current trigger edge source.

Return Format <source><NL>

<source> ::= {CHAN<n> | DIG<d>}

- See Also**
- ["Introduction to :TRIGger Commands"](#) on page 1097
 - [":TRIGger:DElay:TRIGger:SLOPe"](#) on page 1114
 - [":TRIGger:DElay:TDElay:TIME"](#) on page 1112
 - [":TRIGger:DElay:TRIGger:COUNt"](#) on page 1113
 - [":TRIGger:MODE"](#) on page 1106

:TRIGger:EBURst Commands

Table 143: :TRIGger:EBURst Commands Summary

Command	Query	Options and Query Returns
:TRIGger:EBURst:COUNT <count> (see page 1117)	:TRIGger:EBURst:COUNT ? (see page 1117)	<count> ::= integer in NR1 format
:TRIGger:EBURst:IDLE <time_value> (see page 1118)	:TRIGger:EBURst:IDLE? (see page 1118)	<time_value> ::= time in seconds in NR3 format
:TRIGger:EBURst:SLOPe <slope> (see page 1119)	:TRIGger:EBURst:SLOPe ? (see page 1119)	<slope> ::= {NEGative POSitive}
:TRIGger:EBURst:SOURc e <source> (see page 1120)	:TRIGger:EBURst:SOURc e? (see page 1120)	<source> ::= {CHANnel<n> DIGital<d>} <n> ::= 1 to (# analog channels) in NR1 format <d> ::= 0 to (# digital channels - 1) in NR1 format

The :TRIGger:EBURst:SOURce command is used to specify the source channel for the Nth Edge Burst trigger. If an analog channel is selected as the source, the :TRIGger:EDGE:LEVel command is used to set the Nth Edge Burst trigger level. If a digital channel is selected as the source, the :DIGital<n>:THReshold or :POD<n>:THReshold command is used to set the Nth Edge Burst trigger level.

:TRIGger:EBURst:COUNT

N (see [page 1384](#))

Command Syntax :TRIGger:EBURst:COUNT <count>

<count> ::= integer in NR1 format

The :TRIGger:EBURst:COUNT command sets the Nth edge at burst counter resource. The edge counter is used in the trigger stage to determine which edge in a burst will generate a trigger.

Query Syntax :TRIGger:EBURst:COUNT?

The :TRIGger:EBURst:COUNT? query returns the current Nth edge of burst edge counter setting.

Return Format <count><NL>

<count> ::= integer in NR1 format

- See Also**
- ["Introduction to :TRIGger Commands"](#) on page 1097
 - [":TRIGger:EBURst:SLOPe"](#) on page 1119
 - [":TRIGger:EBURst:IDLE"](#) on page 1118

:TRIGger:EBURst:IDLE

N (see [page 1384](#))

Command Syntax :TRIGger:EBURst:IDLE <time_value>

<time_value> ::= time in seconds in NR3 format

The :TRIGger:EBURst:IDLE command sets the Nth edge in a burst idle resource in seconds from 10 ns to 10 s. The timer is used to set the minimum time before the next burst.

Query Syntax :TRIGger:EBURst:IDLE?

The :TRIGger:EBURst:IDLE? query returns current Nth edge in a burst idle setting.

Return Format <time value><NL>

<time_value> ::= time in seconds in NR3 format

- See Also**
- ["Introduction to :TRIGger Commands"](#) on page 1097
 - [":TRIGger:EBURst:SLOPe"](#) on page 1119
 - [":TRIGger:EBURst:COUNt"](#) on page 1117

:TRIGger:EBURst:SLOPe

N (see [page 1384](#))

Command Syntax :TRIGger:EBURst:SLOPe <slope>

<slope> ::= {NEGative | POSitive}

The :TRIGger:EBURst:SLOPe command specifies whether the rising edge (POSitive) or falling edge (NEGative) of the Nth edge in a burst will generate a trigger.

Query Syntax :TRIGger:EBURst:SLOPe?

The :TRIGger:EBURst:SLOPe? query returns the current Nth edge in a burst slope.

Return Format <slope><NL>

<slope> ::= {NEG | POS}

- See Also**
- ["Introduction to :TRIGger Commands"](#) on page 1097
 - [":TRIGger:EBURst:IDLE"](#) on page 1118
 - [":TRIGger:EBURst:COUNt"](#) on page 1117

:TRIGger:EBURst:SOURce

C (see [page 1384](#))

Command Syntax :TRIGger:EBURst:SOURce <source>

<source> ::= {CHANnel<n> | DIGital<d>}

<n> ::= 1 to (# analog channels) in NR1 format

<d> ::= 0 to (# digital channels - 1) in NR1 format

The :TRIGger:EBURst:SOURce command selects the input that produces the Nth edge burst trigger.

Query Syntax :TRIGger:EBURst:SOURce?

The :TRIGger:EBURst:SOURce? query returns the current Nth edge burst trigger source. If all channels are off, the query returns "NONE."

Return Format <source><NL>

<source> ::= {CHAN<n> | DIG<d>}

- See Also**
- ["Introduction to :TRIGger Commands"](#) on page 1097
 - [":TRIGger:MODE"](#) on page 1106

:TRIGger[:EDGE] Commands

Table 144 :TRIGger[:EDGE] Commands Summary

Command	Query	Options and Query Returns
:TRIGger[:EDGE]:COUPling {AC DC LFReject} (see page 1122)	:TRIGger[:EDGE]:COUPling? (see page 1122)	{AC DC LFReject}
:TRIGger[:EDGE]:LEVel <level> [, <source>] (see page 1123)	:TRIGger[:EDGE]:LEVel? [<source>] (see page 1123)	For internal triggers, <level> ::= .75 x full-scale voltage from center screen in NR3 format. For external triggers, <level> ::= ±(external range setting) in NR3 format. For digital channels (MSO models), <level> ::= ±8 V. <source> ::= {CHANnel<n> EXTErnal} for DSO models <source> ::= {CHANnel<n> DIGital<d> EXTErnal} for MSO models <n> ::= 1 to (# analog channels) in NR1 format <d> ::= 0 to (# digital channels - 1) in NR1 format
:TRIGger[:EDGE]:REJect {OFF LFReject HFReject} (see page 1124)	:TRIGger[:EDGE]:REJect? (see page 1124)	{OFF LFReject HFReject}
:TRIGger[:EDGE]:SLOPe <polarity> (see page 1125)	:TRIGger[:EDGE]:SLOPe? (see page 1125)	<polarity> ::= {POSitive NEGative EITHer ALTErnate}
:TRIGger[:EDGE]:SOURC e <source> (see page 1126)	:TRIGger[:EDGE]:SOURC e? (see page 1126)	<source> ::= {CHANnel<n> EXTErnal LINE WGEN WGEN1 WMOD} for the DSO models <source> ::= {CHANnel<n> DIGital<d> EXTErnal LINE WGEN WGEN1 WMOD} for the MSO models <n> ::= 1 to (# analog channels) in NR1 format <d> ::= 0 to (# digital channels - 1) in NR1 format Note: WGEN and WGEN1 are equivalent.

:TRIGger[:EDGE]:COUpling

C (see [page 1384](#))

Command Syntax :TRIGger[:EDGE]:COUpling <coupling>
<coupling> ::= {AC | DC | LFReject}

The :TRIGger[:EDGE]:COUpling command sets the input coupling for the selected trigger sources. The coupling can be set to AC, DC, or LFReject.

- AC coupling places a high-pass filter (10 Hz for analog channels, and 3.5 Hz for all External trigger inputs) in the trigger path, removing dc offset voltage from the trigger waveform. Use AC coupling to get a stable edge trigger when your waveform has a large dc offset.
- LFReject coupling places a 50 KHz high-pass filter in the trigger path.
- DC coupling allows dc and ac signals into the trigger path.

NOTE

The :TRIGger[:EDGE]:COUpling and the :TRIGger[:EDGE]:REJect selections are coupled. Changing the setting of the :TRIGger[:EDGE]:REJect can change the COUpling setting.

Query Syntax :TRIGger[:EDGE]:COUpling?

The :TRIGger[:EDGE]:COUpling? query returns the current coupling selection.

Return Format <coupling><NL>
<coupling> ::= {AC | DC | LFR}

- See Also**
- ["Introduction to :TRIGger Commands"](#) on page 1097
 - [":TRIGger:MODE"](#) on page 1106
 - [":TRIGger\[:EDGE\]:REJect"](#) on page 1124

:TRIGger[:EDGE]:LEVel

C (see [page 1384](#))

Command Syntax :TRIGger[:EDGE]:LEVel <level>
 <level> ::= <level>[,<source>]
 <level> ::= 0.75 x full-scale voltage from center screen in NR3 format
 for internal triggers
 <level> ::= ±(external range setting) in NR3 format
 for external triggers
 <level> ::= ±8 V for digital channels (MSO models)
 <source> ::= {CHANnel<n> | EXTernal} for the DSO models
 <source> ::= {CHANnel<n> | DIGital<d> | EXTernal}
 for the MSO models
 <n> ::= 1 to (# analog channels) in NR1 format
 <d> ::= 0 to (# digital channels - 1) in NR1 format
 The :TRIGger[:EDGE]:LEVel command sets the trigger level voltage for the active
 trigger source.

NOTE

If the optional source is specified and is not the active source, the level on the active source is not affected and the active source is not changed.

Query Syntax :TRIGger[:EDGE]:LEVel? [<source>]

The :TRIGger[:EDGE]:LEVel? query returns the trigger level of the current trigger source.

Return Format <level><NL>

- See Also**
- ["Introduction to :TRIGger Commands"](#) on page 1097
 - [":TRIGger\[:EDGE\]:SOURce"](#) on page 1126
 - [":EXTernal:RANGe"](#) on page 368
 - [":POD<n>:THReshold"](#) on page 619
 - [":DIGital<d>:THReshold"](#) on page 339

:TRIGger[:EDGE]:REJect

C (see [page 1384](#))

Command Syntax `:TRIGger[:EDGE]:REJect <reject>`
`<reject> ::= {OFF | LFReject | HFReject}`

The `:TRIGger[:EDGE]:REJect` command turns the low-frequency or high-frequency reject filter on or off. You can turn on one of these filters at a time.

- The high frequency reject filter adds a 50 kHz low-pass filter in the trigger path to remove high frequency components from the trigger waveform. Use the high frequency reject filter to remove high-frequency noise, such as AM or FM broadcast stations, from the trigger path.
- The low frequency reject filter adds a 50 kHz high-pass filter in series with the trigger waveform to remove any unwanted low frequency components from a trigger waveform, such as power line frequencies, that can interfere with proper triggering.

NOTE

The `:TRIGger[:EDGE]:REJect` and the `:TRIGger[:EDGE]:COUPling` selections are coupled. Changing the setting of the `:TRIGger[:EDGE]:COUPling` can change the `COUPling` setting.

Query Syntax `:TRIGger[:EDGE]:REJect?`

The `:TRIGger[:EDGE]:REJect?` query returns the current status of the reject filter.

Return Format `<reject><NL>`
`<reject> ::= {OFF | LFR | HFR}`

- See Also**
- ["Introduction to :TRIGger Commands"](#) on page 1097
 - [":TRIGger:HFReject"](#) on page 1101
 - [":TRIGger\[:EDGE\]:COUPling"](#) on page 1122

:TRIGger[:EDGE]:SLOPe

C (see [page 1384](#))

Command Syntax :TRIGger[:EDGE]:SLOPe <slope>

<slope> ::= {NEGative | POSitive | EITHer | ALTErnate}

The :TRIGger[:EDGE]:SLOPe command specifies the slope of the edge for the trigger. The SLOPe command is not valid in TV trigger mode. Instead, use :TRIGger:TV:POLarity to set the polarity in TV trigger mode.

Query Syntax :TRIGger[:EDGE]:SLOPe?

The :TRIGger[:EDGE]:SLOPe? query returns the current trigger slope.

Return Format <slope><NL>

<slope> ::= {NEG | POS | EITH | ALT}

- See Also**
- ["Introduction to :TRIGger Commands"](#) on page 1097
 - [":TRIGger:MODE"](#) on page 1106
 - [":TRIGger:TV:POLarity"](#) on page 1175

Example Code ' TRIGGER_EDGE_SLOPE - Sets the slope of the edge for the trigger.

```
' Set the slope to positive.
myScope.WriteString ":TRIGGER:EDGE:SLOPE POSITIVE"
```

See complete example programs at: [Chapter 42](#), "Programming Examples," starting on page 1393

:TRIGger[:EDGE]:SOURce**C** (see [page 1384](#))**Command Syntax** :TRIGger[:EDGE]:SOURce <source>`<source> ::= {CHANnel<n> | EXTErnal | LINE | WGEN | WGEN1
| WMOD} for the DSO models``<source> ::= {CHANnel<n> | DIGital<d> | EXTErnal | LINE | WGEN | WGEN1
| WMOD} for the MSO models``<n> ::= 1 to (# analog channels) in NR1 format``<d> ::= 0 to (# digital channels - 1) in NR1 format`

Note: WAVE and WGEN1 are equivalent.

The :TRIGger[:EDGE]:SOURce command selects the input that produces the trigger.

- EXTErnal – triggers on the rear panel EXT TRIG IN signal.
- LINE – triggers at the 50% level of the rising or falling edge of the AC power source signal.
- WGEN, WGEN1 – triggers at the 50% level of the rising edge of the waveform generator output signal. This option is not available when the DC, NOISe, or CARDiac waveforms are selected.
- WMOD – when waveform generator FSK or FM modulation is used, triggers at the 50% level of the rising edge of the modulating signal.

Query Syntax :TRIGger[:EDGE]:SOURce?

The :TRIGger[:EDGE]:SOURce? query returns the current source. If all channels are off, the query returns "NONE."

Return Format <source><NL>`<source> ::= {CHAN<n> | EXT | LINE | WGEN | WGEN1 | WMOD
| NONE} for the DSO models``<source> ::= {CHAN<n> | DIG<d> | EXTErnal | LINE | WGEN | WGEN1
| WMOD | NONE} for the MSO models`

- See Also**
- ["Introduction to :TRIGger Commands"](#) on page 1097
 - [":TRIGger:MODE"](#) on page 1106

Example Code

```
' TRIGGER_EDGE_SOURCE - Selects the channel that actually produces the
e
' edge trigger. Any channel can be selected.
myScope.WriteString ":TRIGger:EDGE:SOURce CHANnel1"
```

See complete example programs at: [Chapter 42](#), "Programming Examples," starting on page 1393

:TRIGger:GLITCh Commands

Table 145: :TRIGger:GLITCh Commands Summary

Command	Query	Options and Query Returns
:TRIGger:GLITCh:GREAt erthan <greater_than_time>[s uffix] (see page 1129)	:TRIGger:GLITCh:GREAt erthan? (see page 1129)	<greater_than_time> ::= floating-point number in NR3 format [suffix] ::= {s ms us ns ps}
:TRIGger:GLITCh:LESSt han <less_than_time>[suff ix] (see page 1130)	:TRIGger:GLITCh:LESSt han? (see page 1130)	<less_than_time> ::= floating-point number in NR3 format [suffix] ::= {s ms us ns ps}
:TRIGger:GLITCh:LEVel <level> [<source>] (see page 1131)	:TRIGger:GLITCh:LEVel ? (see page 1131)	For internal triggers, <level> ::= .75 x full-scale voltage from center screen in NR3 format. For external triggers (DSO models), <level> ::= ±(external range setting) in NR3 format. For digital channels (MSO models), <level> ::= ±8 V. <source> ::= {CHANnel<n> EXTErnal} for DSO models <source> ::= {CHANnel<n> DIGital<d>} for MSO models <n> ::= 1 to (# analog channels) in NR1 format <d> ::= 0 to (# digital channels - 1) in NR1 format
:TRIGger:GLITCh:POLar ity <polarity> (see page 1132)	:TRIGger:GLITCh:POLar ity? (see page 1132)	<polarity> ::= {POSitive NEGative}
:TRIGger:GLITCh:QUALi fier <qualifier> (see page 1133)	:TRIGger:GLITCh:QUALi fier? (see page 1133)	<qualifier> ::= {GREAterthan LESSthan RANGE}

Table 145: TRIGger:GLITCh Commands Summary (continued)

Command	Query	Options and Query Returns
:TRIGger:GLITCh:RANGe <less_than_time>[suffix], <greater_than_time>[suffix] (see page 1134)	:TRIGger:GLITCh:RANGe? (see page 1134)	<less_than_time> ::= 15 ns to 10 seconds in NR3 format <greater_than_time> ::= 10 ns to 9.99 seconds in NR3 format [suffix] ::= {s ms us ns ps}
:TRIGger:GLITCh:SOURCe <source> (see page 1135)	:TRIGger:GLITCh:SOURCe? (see page 1135)	<source> ::= {CHANnel<n> DIGital<d>} <n> ::= 1 to (# analog channels) in NR1 format <d> ::= 0 to (# digital channels - 1) in NR1 format

:TRIGger:GLITch:GREaterthan

N (see [page 1384](#))

Command Syntax :TRIGger:GLITch:GREaterthan <greater_than_time> [<suffix>]
 <greater_than_time> ::= floating-point number in NR3 format
 <suffix> ::= {s | ms | us | ns | ps}

The :TRIGger:GLITch:GREaterthan command sets the minimum pulse width duration for the selected :TRIGger:GLITch:SOURce.

Query Syntax :TRIGger:GLITch:GREaterthan?

The :TRIGger:GLITch:GREaterthan? query returns the minimum pulse width duration time for :TRIGger:GLITch:SOURce.

Return Format <greater_than_time><NL>
 <greater_than_time> ::= floating-point number in NR3 format.

- See Also**
- ["Introduction to :TRIGger Commands"](#) on page 1097
 - [":TRIGger:GLITch:SOURce"](#) on page 1135
 - [":TRIGger:GLITch:QUALifier"](#) on page 1133
 - [":TRIGger:MODE"](#) on page 1106

:TRIGger:GLITCh:LESSthan

N (see [page 1384](#))

Command Syntax :TRIGger:GLITCh:LESSthan <less_than_time> [<suffix>]

<less_than_time> ::= floating-point number in NR3 format

<suffix> ::= {s | ms | us | ns | ps}

The :TRIGger:GLITCh:LESSthan command sets the maximum pulse width duration for the selected :TRIGger:GLITCh:SOURce.

Query Syntax :TRIGger:GLITCh:LESSthan?

The :TRIGger:GLITCh:LESSthan? query returns the pulse width duration time for :TRIGger:GLITCh:SOURce.

Return Format <less_than_time><NL>

<less_than_time> ::= floating-point number in NR3 format.

- See Also**
- ["Introduction to :TRIGger Commands"](#) on page 1097
 - [":TRIGger:GLITCh:SOURce"](#) on page 1135
 - [":TRIGger:GLITCh:QUALifier"](#) on page 1133
 - [":TRIGger:MODE"](#) on page 1106

:TRIGger:GLITch:LEVel

N (see [page 1384](#))

Command Syntax :TRIGger:GLITch:LEVel <level_argument>
 <level_argument> ::= <level>[, <source>]
 <level> ::= .75 x full-scale voltage from center screen in NR3 format
 for internal triggers
 <level> ::= ±(external range setting) in NR3 format
 for external triggers (DSO models)
 <level> ::= ±8 V for digital channels (MSO models)
 <source> ::= {CHANnel<n> | EXTernal} for DSO models
 <source> ::= {CHANnel<n> | DIGital<d>} for MSO models
 <n> ::= 1 to (# analog channels) in NR1 format
 <d> ::= 0 to (# digital channels - 1) in NR1 format

The :TRIGger:GLITch:LEVel command sets the trigger level voltage for the active pulse width trigger.

Query Syntax :TRIGger:GLITch:LEVel?

The :TRIGger:GLITch:LEVel? query returns the trigger level of the current pulse width trigger mode. If all channels are off, the query returns "NONE."

Return Format <level_argument><NL>

- See Also**
- ["Introduction to :TRIGger Commands"](#) on page 1097
 - [":TRIGger:MODE"](#) on page 1106
 - [":TRIGger:GLITch:SOURce"](#) on page 1135
 - [":EXTernal:RANGe"](#) on page 368

:TRIGger:GLITch:POLarity

N (see [page 1384](#))

Command Syntax :TRIGger:GLITch:POLarity <polarity>
 <polarity> ::= {POSitive | NEGative}

The :TRIGger:GLITch:POLarity command sets the polarity for the glitch pulse width trigger.

Query Syntax :TRIGger:GLITch:POLarity?

The :TRIGger:GLITch:POLarity? query returns the glitch pulse width trigger polarity.

Return Format <polarity><NL>
 <polarity> ::= {POS | NEG}

- See Also**
- ["Introduction to :TRIGger Commands"](#) on page 1097
 - [":TRIGger:MODE"](#) on page 1106
 - [":TRIGger:GLITch:SOURce"](#) on page 1135

:TRIGger:GLITch:QUALifier

N (see [page 1384](#))

Command Syntax :TRIGger:GLITch:QUALifier <operator>

<operator> ::= {GREATERthan | LESSthan | RANGE}

This command sets the mode of operation of the glitch pulse width trigger. The oscilloscope can trigger on a pulse width that is greater than a time value, less than a time value, or within a range of time values.

Query Syntax :TRIGger:GLITch:QUALifier?

The :TRIGger:GLITch:QUALifier? query returns the glitch pulse width qualifier.

Return Format <operator><NL>

<operator> ::= {GRE | LESS | RANG}

- See Also**
- ["Introduction to :TRIGger Commands"](#) on page 1097
 - [":TRIGger:GLITch:SOURce"](#) on page 1135
 - [":TRIGger:MODE"](#) on page 1106

:TRIGger:GLITch:SOURce

N (see [page 1384](#))

Command Syntax :TRIGger:GLITch:SOURce <source>

<source> ::= {DIGital<d> | CHANnel<n>}

<n> ::= 1 to (# analog channels) in NR1 format

<d> ::= 0 to (# digital channels - 1) in NR1 format

The :TRIGger:GLITch:SOURce command selects the channel that produces the pulse width trigger.

Query Syntax :TRIGger:GLITch:SOURce?

The :TRIGger:GLITch:SOURce? query returns the current pulse width source. If all channels are off, the query returns "NONE".

Return Format <source><NL>

- See Also**
- ["Introduction to :TRIGger Commands"](#) on page 1097
 - [":TRIGger:MODE"](#) on page 1106
 - [":TRIGger:GLITch:LEVel"](#) on page 1131
 - [":TRIGger:GLITch:POLarity"](#) on page 1132
 - [":TRIGger:GLITch:QUALifier"](#) on page 1133
 - [":TRIGger:GLITch:RANGE"](#) on page 1134

Example Code • ["Example Code"](#) on page 1126

:TRIGger:NFC Commands

NFC (Near Field Communication) triggering is used to capture waveforms used in NFC testing. The NFC trigger mode is license-enabled.

Table 146: :TRIGger:NFC Commands Summary

Command	Query	Options and Query Returns
:TRIGger:NFC:AEVent <arm_event> (see page 1137)	:TRIGger:NFC:AEVent? (see page 1137)	<arm_event> ::= {NONE ASReq AALLreq AEITher BSReq BALLreq BEITher FSReq}
n/a	:TRIGger:NFC:ATTime? (see page 1138)	<time> ::= seconds in NR3 format
:TRIGger:NFC:SOURce <source> (see page 1139)	:TRIGger:NFC:SOURce? (see page 1139)	<source> ::= CHANNEL<n> <n> ::= 1 to (# analog channels) in NR1 format
:TRIGger:NFC:STANdard <standard> (see page 1140)	:TRIGger:NFC:STANdard ? (see page 1140)	<standard> ::= {{A A106} {B B106} F212 F424}
:TRIGger:NFC:TEVent <trigger_event> (see page 1141)	:TRIGger:NFC:TEVent? (see page 1141)	<trigger_event> ::= {ATRigger ASReq AALLreq AEITher ASDDreq BSReq BALLreq BEITher BATTrib FSReq FAReq FPReamble}
n/a	:TRIGger:NFC:TImeout? (see page 1143)	{0 1}
:TRIGger:NFC:TImeout: ENABle {{0 OFF} {1 ON}} (see page 1144)	:TRIGger:NFC:TImeout: ENABle? (see page 1144)	{0 1}
:TRIGger:NFC:TImeout: TIME <time> (see page 1145)	:TRIGger:NFC:TImeout: TIME? (see page 1145)	<time> ::= seconds in NR3 format

:TRIGger:NFC:AEvent

N (see [page 1384](#))

Command Syntax :TRIGger:NFC:AEvent <arm_event>

```
<arm_event> ::= {NONE | ASReq | AALLreq | AEITher | BSReq | BALLreq
| BEITher | FSReq}
```

When the ATRigger (Arm & Trigger) trigger event is selected (by :TRIGger:NFC:TEvent), the :TRIGger:NFC:AEvent command specifies the arm event. Valid arm event settings depend on the signaling technology selected (by :TRIGger:NFC:STANdard):

Signaling Technology	Arm Event	Description
NFC-A	ASReq	SENS_REQ
	AALLreq	ALL_REQ
	AEITher	Either the SENS_REQ or ALL_REQ events will arm.
NFC-B	BSReq	SENSB_REQ
	BALLreq	ALLB_REQ
	BEITher	Either the SENSB_REQ or ALLB_REQ events will arm.
NFC-F	FSReq	SENSF_REQ

When a trigger event other than ATRigger (Arm & Trigger) is selected, the arm event is NONE.

Query Syntax :TRIGger:NFC:AEvent?

The :TRIGger:NFC:AEvent? query returns the specified arm event.

Return Format <arm_event><NL>

```
<arm_event> ::= {NONE | ASR | AALL | AEIT | BSR | BALL | BEIT | FSR}
```

- See Also**
- [":TRIGger:NFC:ATTime"](#) on page 1138
 - [":TRIGger:NFC:SOURce"](#) on page 1139
 - [":TRIGger:NFC:STANdard"](#) on page 1140
 - [":TRIGger:NFC:TEVent"](#) on page 1141
 - [":TRIGger:NFC:TIMEout"](#) on page 1143
 - [":TRIGger:NFC:TIMEout:ENABLE"](#) on page 1144
 - [":TRIGger:NFC:TIMEout:TIME"](#) on page 1145

:TRIGger:NFC:ATTime

N (see [page 1384](#))

Query Syntax :TRIGger:NFC:ATTime?

The :TRIGger:NFC:ATTime? query returns the time between the arm and the trigger when the ATRigger (Arm & Trigger) trigger event is selected.

Return Format <time><NL>

<time> ::= seconds in NR3 format

- See Also**
- [":TRIGger:NFC:AEVent"](#) on page 1137
 - [":TRIGger:NFC:SOURce"](#) on page 1139
 - [":TRIGger:NFC:STANdard"](#) on page 1140
 - [":TRIGger:NFC:TEVent"](#) on page 1141
 - [":TRIGger:NFC:TIMEout"](#) on page 1143
 - [":TRIGger:NFC:TIMEout:ENABle"](#) on page 1144
 - [":TRIGger:NFC:TIMEout:TIME"](#) on page 1145

:TRIGger:NFC:SOURce

N (see [page 1384](#))

Command Syntax :TRIGger:NFC:SOURce <source>

<source> ::= CHANnel<n>

<n> ::= 1 to (# analog channels) in NR1 format

The :TRIGger:NFC:SOURce command selects the input waveform source for the NFC trigger. You can choose an analog input channel.

Query Syntax :TRIGger:NFC:SOURce?

The :TRIGger:NFC:SOURce? query returns the input waveform source setting.

Return Format <source><NL>

<source> ::= CHAN<n>

- See Also**
- [":TRIGger:NFC:AEVent"](#) on page 1137
 - [":TRIGger:NFC:ATTime"](#) on page 1138
 - [":TRIGger:NFC:STANdard"](#) on page 1140
 - [":TRIGger:NFC:TEVent"](#) on page 1141
 - [":TRIGger:NFC:TIMEout"](#) on page 1143
 - [":TRIGger:NFC:TIMEout:ENABle"](#) on page 1144
 - [":TRIGger:NFC:TIMEout:TIME"](#) on page 1145

:TRIGger:NFC:STANdard

N (see [page 1384](#))

Command Syntax :TRIGger:NFC:STANdard <standard>

<standard> ::= {{A | A106} | {B | B106} | F212 | F424}

The :TRIGger:NFC:STANdard command selects the signaling technology used by the input signal:

- A or A106 – NFC-A standard, 106 kbits/s.
- B or B106 – NFC-A standard, 106 kbits/s.
- F212 – NFC-F standard, 212 kbits/s.
- F424 – NFC-F standard, 424 kbits/s.

Query Syntax :TRIGger:NFC:STANdard?

The :TRIGger:NFC:STANdard? query returns the signaling technology setting.

Return Format <standard><NL>

<standard> ::= {{A | A106} | {B | B106} | F212 | F424}

- See Also**
- [":TRIGger:NFC:AEVent"](#) on page 1137
 - [":TRIGger:NFC:ATTime"](#) on page 1138
 - [":TRIGger:NFC:SOURce"](#) on page 1139
 - [":TRIGger:NFC:TEVent"](#) on page 1141
 - [":TRIGger:NFC:TIMEout"](#) on page 1143
 - [":TRIGger:NFC:TIMEout:ENABLE"](#) on page 1144
 - [":TRIGger:NFC:TIMEout:TIME"](#) on page 1145

:TRIGger:NFC:TEvent

N (see [page 1384](#))

Command Syntax :TRIGger:NFC:TEvent <trigger_event>

```
<trigger_event> ::= {ATRigger | ASReq | AALLreq | AEITher | ASDDreq
    | BSReq | BALLreq | BEITher | BATTRib | FSReq | FAReq | FPReamble}
```

The :TRIGger:NFC:TEvent command specifies the trigger event. Valid trigger event settings depend on the signaling technology selected (by :TRIGger:NFC:STANdard):

Signaling Technology	Trigger Event	Description
NFC-A	ATRigger	The arm event is specified by :TRIGger:NFC:AEvent, and the trigger event is SDD_REQ.
	ASReq	SENS_REQ
	AALLreq	ALL_REQ
	AEITher	Either the SENS_REQ or ALL_REQ events will cause a trigger.
	ASDDreq	SDD_REQ
NFC-B	ATRigger	The arm event is specified by :TRIGger:NFC:AEvent, and the trigger event is ATTRIB.
	BSReq	SENSB_REQ
	BALLreq	ALLB_REQ
	BEITher	Either the SENSB_REQ or ALLB_REQ events will cause a trigger.
	BATTRib	ATTRIB
NFC-F	ATRigger	The arm event is specified by :TRIGger:NFC:AEvent, and the trigger event is ATR_REQ.
	FSReq	SENSF_REQ
	FAReq	ATR_REQ
	FPReamble	The preamble sequence that begins a data frame will cause a trigger.

Query Syntax :TRIGger:NFC:TEvent?

The :TRIGger:NFC:TEvent? query returns the specified trigger event.

Return Format <trigger_event><NL>

```
<trigger_event> ::= {ATR | ASR | AALL | AEIT | ASDD | BSR | BALL
    | BEIT | BATT | FSR | FAR | FPR}
```

See Also • [":TRIGger:NFC:AEvent"](#) on page 1137

- **":TRIGger:NFC:ATTime"** on page 1138
- **":TRIGger:NFC:SOURce"** on page 1139
- **":TRIGger:NFC:STANdard"** on page 1140
- **":TRIGger:NFC:TIMeout"** on page 1143
- **":TRIGger:NFC:TIMeout:ENABle"** on page 1144
- **":TRIGger:NFC:TIMeout:TIME"** on page 1145

:TRIGger:NFC:TIMEout

N (see [page 1384](#))

Query Syntax :TRIGger:NFC:TIMEout?

The :TRIGger:NFC:TIMEout? query returns whether the timeout occurred.

With the ATRigger (Arm & Trigger) trigger event, if the second event does not occur within the timeout period, the oscilloscope triggers when the timeout period expires.

A return value of 1 says the desired trigger event did not occur within the specified time after the arm event.

A return value of 0 says the desired trigger event occurred before the timeout.

Return Format <timeout_occurred><NL>

{0 | 1}

- See Also**
- [":TRIGger:NFC:AEVEnt"](#) on page 1137
 - [":TRIGger:NFC:ATTime"](#) on page 1138
 - [":TRIGger:NFC:SOURce"](#) on page 1139
 - [":TRIGger:NFC:STANdard"](#) on page 1140
 - [":TRIGger:NFC:TEVEnt"](#) on page 1141
 - [":TRIGger:NFC:TIMEout:ENABle"](#) on page 1144
 - [":TRIGger:NFC:TIMEout:TIME"](#) on page 1145

:TRIGger:NFC:TIMEout:ENABle

N (see [page 1384](#))

Command Syntax :TRIGger:NFC:TIMEout:ENABle {1 | ON}

The :TRIGger:NFC:TIMEout:ENABle command enables the timeout period. Currently, ON is the only valid setting.

With the ATRigger (Arm & Trigger) trigger event, if the second event does not occur within the timeout period, the oscilloscope triggers when the timeout period expires.

Query Syntax :TRIGger:NFC:TIMEout:ENABle?

The :TRIGger:NFC:TIMEout:ENABle? query returns the timeout period enable setting.

Return Format <setting><NL>

{1}

- See Also**
- [":TRIGger:NFC:AEVEnt"](#) on page 1137
 - [":TRIGger:NFC:ATTime"](#) on page 1138
 - [":TRIGger:NFC:SOURce"](#) on page 1139
 - [":TRIGger:NFC:STANdard"](#) on page 1140
 - [":TRIGger:NFC:TEVEnt"](#) on page 1141
 - [":TRIGger:NFC:TIMEout"](#) on page 1143
 - [":TRIGger:NFC:TIMEout:TIME"](#) on page 1145

:TRIGger:NFC:TIMEout:TIME

N (see [page 1384](#))

Command Syntax :TRIGger:NFC:TIMEout:TIME <time>
 <time> ::= seconds in NR3 format

The :TRIGger:NFC:TIMEout:TIME command specifies the timeout period. With the ATRigger (Arm & Trigger) trigger event, if the second event does not occur within the timeout period, the oscilloscope triggers when the timeout period expires.

Query Syntax :TRIGger:NFC:TIMEout:TIME?

The :TRIGger:NFC:TIMEout:TIME? query returns the specified timeout period.

Return Format <time><NL>
 <time> ::= seconds in NR3 format

- See Also**
- [":TRIGger:NFC:AEVent"](#) on page 1137
 - [":TRIGger:NFC:ATTime"](#) on page 1138
 - [":TRIGger:NFC:SOURce"](#) on page 1139
 - [":TRIGger:NFC:STANdard"](#) on page 1140
 - [":TRIGger:NFC:TEVent"](#) on page 1141
 - [":TRIGger:NFC:TIMEout"](#) on page 1143
 - [":TRIGger:NFC:TIMEout:ENABLE"](#) on page 1144

:TRIGger:OR Commands

Table 147:TRIGger:OR Commands Summary

Command	Query	Options and Query Returns
:TRIGger:OR <string> (see page 1147)	:TRIGger:OR? (see page 1147)	<string> ::= "nn...n" where n ::= {R F E X} R = rising edge, F = falling edge, E = either edge, X = don't care. Each character in the string is for an analog or digital channel as shown on the front panel display.

:TRIGger:OR

N (see [page 1384](#))

Command Syntax :TRIGger:OR <string>

<string> ::= "nn...n" where n ::= {R | F | E | X}

R = rising edge, F = falling edge, E = either edge, X = don't care.

The :TRIGger:OR command specifies the edges to include in the OR'ed edge trigger.

In the <string> parameter, each bit corresponds to a channel as described in the following table:

Oscilloscope Models	Value and Mask Bit Assignments
4 analog + 16 digital channels (mixed-signal)	Bits 0 through 15 - digital channels 0 through 15. Bits 16 through 19 - analog channels 4 through 1.
2 analog + 16 digital channels (mixed-signal)	Bits 0 through 15 - digital channels 0 through 15. Bits 16 and 17 - analog channels 2 and 1.
4 analog channels only	Bits 0 through 3 - analog channels 4 through 1.
2 analog channels only	Bits 0 and 1 - analog channels 2 and 1.

Query Syntax :TRIGger:OR?

The :TRIGger:OR? query returns the current OR'ed edge trigger string.

Return Format <string><NL>

- See Also**
- ["Introduction to :TRIGger Commands"](#) on page 1097
 - [":TRIGger:MODE"](#) on page 1106

:TRIGger:PATtern Commands

Table 148: :TRIGger:PATtern Commands Summary

Command	Query	Options and Query Returns
:TRIGger:PATtern <string>[,<edge_source>,<edge>] (see page 1149)	:TRIGger:PATtern? (see page 1150)	<string> ::= "nn...n" where n ::= {0 1 X R F} when <base> = ASCii <string> ::= "0xnn...n" where n ::= {0,...,9 A,...,F X \$} when <base> = HEX <edge_source> ::= {CHANnel<n> NONE} for DSO models <edge_source> ::= {CHANnel<n> DIGital<d> NONE} for MSO models <n> ::= 1 to (# analog channels) in NR1 format <d> ::= 0 to (# digital channels - 1) in NR1 format <edge> ::= {POSitive NEGative}
:TRIGger:PATtern:FORM at <base> (see page 1151)	:TRIGger:PATtern:FORM at? (see page 1151)	<base> ::= {ASCii HEX}
:TRIGger:PATtern:GREa terthan <greater_than_time>[suffix] (see page 1152)	:TRIGger:PATtern:GREa terthan? (see page 1152)	<greater_than_time> ::= floating-point number in NR3 format [suffix] ::= {s ms us ns ps}
:TRIGger:PATtern:LESS than <less_than_time>[suffix] (see page 1153)	:TRIGger:PATtern:LESS than? (see page 1153)	<less_than_time> ::= floating-point number in NR3 format [suffix] ::= {s ms us ns ps}
:TRIGger:PATtern:QUAL ifier <qualifier> (see page 1154)	:TRIGger:PATtern:QUAL ifier? (see page 1154)	<qualifier> ::= {ENTERed GREaterthan LESSthan INRange OUTRange TIMEout}
:TRIGger:PATtern:RANG e <less_than_time>[suffix], <greater_than_time>[suffix] (see page 1155)	:TRIGger:PATtern:RANG e? (see page 1155)	<less_than_time> ::= 15 ns to 10 seconds in NR3 format <greater_than_time> ::= 10 ns to 9.99 seconds in NR3 format [suffix] ::= {s ms us ns ps}

:TRIGger:PATtern

C (see [page 1384](#))

Command Syntax :TRIGger:PATtern <pattern>

<pattern> ::= <string>[, <edge_source>, <edge>]

<string> ::= "nn...n" where n ::= {0 | 1 | X | R | F} when
<base> = ASCII

<string> ::= "0xnn...n" where n ::= {0,...,9 | A,...,F | X | \$} when
<base> = HEX

<edge_source> ::= {CHANnel<n> | NONE} for DSO models

<edge_source> ::= {CHANnel<n> | DIGital<d>
| NONE} for MSO models

<n> ::= 1 to (# of analog channels) in NR1 format

<d> ::= 0 to (# digital channels - 1) in NR1 format

<edge> ::= {POSitive | NEGative}

The :TRIGger:PATtern command specifies the channel values to be used in the pattern trigger.

In the <string> parameter, each bit corresponds to a channel as described in the following table:

Oscilloscope Models	Value and Mask Bit Assignments
4 analog + 16 digital channels (mixed-signal)	Bits 0 through 15 - digital channels 0 through 15. Bits 16 through 19 - analog channels 4 through 1.
2 analog + 16 digital channels (mixed-signal)	Bits 0 through 15 - digital channels 0 through 15. Bits 16 and 17 - analog channels 2 and 1.
4 analog channels only	Bits 0 through 3 - analog channels 4 through 1.
2 analog channels only	Bits 0 and 1 - analog channels 2 and 1.

The format of the <string> parameter depends on the :TRIGger:PATtern:FORMat command setting:

- When the format is ASCII, the string looks just like the string you see on the oscilloscope's front panel, made up of 0, 1, X (don't care), R (rising edge), and F (falling edge) characters.
- When the format is HEX, the string begins with "0x" and contains hex digit characters or X (don't care for all four bits in the nibble).

With the hex format string, you can use the <edge_source> and <edge> parameters to specify an edge on one of the channels.

NOTE

The optional <edge_source> and <edge> parameters should be sent together or not at all. The edge can be specified in the ASCII <string> parameter. If the edge source and edge parameters are used, they take precedence.

You can only specify an edge on one channel. When an edge is specified, the :TRIGger:PATtern:QUALifier does not apply.

Query Syntax :TRIGger:PATtern?

The :TRIGger:PATtern? query returns the pattern string, edge source, and edge.

Return Format <string>, <edge_source>, <edge><NL>

- See Also**
- ["Introduction to :TRIGger Commands"](#) on page 1097
 - [":TRIGger:PATtern:FORMat"](#) on page 1151
 - [":TRIGger:PATtern:QUALifier"](#) on page 1154
 - [":TRIGger:MODE"](#) on page 1106

:TRIGger:PATtern:FORMat

N (see [page 1384](#))

Command Syntax :TRIGger:PATtern:FORMat <base>
 <base> ::= {ASCii | HEX}

The :TRIGger:PATtern:FORMat command sets the entry (and query) number base used by the :TRIGger:PATtern command. The default <base> is ASCii.

Query Syntax :TRIGger:PATtern:FORMat?

The :TRIGger:PATtern:FORMat? query returns the currently set number base for pattern trigger patterns.

Return Format <base><NL>
 <base> ::= {ASC | HEX}

- See Also**
- ["Introduction to :TRIGger Commands"](#) on page 1097
 - [":TRIGger:PATtern"](#) on page 1149

:TRIGger:PATtern:GREaterthan

N (see [page 1384](#))

Command Syntax :TRIGger:PATtern:GREaterthan <greater_than_time> [<suffix>]
 <greater_than_time> ::= minimum trigger duration in seconds
 in NR3 format
 <suffix> ::= {s | ms | us | ns | ps }

The :TRIGger:PATtern:GREaterthan command sets the minimum duration for the defined pattern when :TRIGger:PATtern:QUALifier is set to GREaterthan. The command also sets the timeout value when the :TRIGger:PATtern:QUALifier is set to TIMEout.

Query Syntax :TRIGger:PATtern:GREaterthan?

The :TRIGger:PATtern:GREaterthan? query returns the minimum duration time for the defined pattern.

Return Format <greater_than_time><NL>

- See Also**
- ["Introduction to :TRIGger Commands"](#) on page 1097
 - [":TRIGger:PATtern"](#) on page 1149
 - [":TRIGger:PATtern:QUALifier"](#) on page 1154
 - [":TRIGger:MODE"](#) on page 1106

:TRIGger:PATtern:LESSthan

N (see [page 1384](#))

Command Syntax :TRIGger:PATtern:LESSthan <less_than_time> [<suffix>]
 <less_than_time> ::= maximum trigger duration in seconds
 in NR3 format
 <suffix> ::= {s | ms | us | ns | ps}

The :TRIGger:PATtern:LESSthan command sets the maximum duration for the defined pattern when :TRIGger:PATtern:QUALifier is set to LESSthan.

Query Syntax :TRIGger:PATtern:LESSthan?

The :TRIGger:PATtern:LESSthan? query returns the duration time for the defined pattern.

Return Format <less_than_time><NL>

- See Also**
- ["Introduction to :TRIGger Commands"](#) on page 1097
 - [":TRIGger:PATtern"](#) on page 1149
 - [":TRIGger:PATtern:QUALifier"](#) on page 1154
 - [":TRIGger:MODE"](#) on page 1106

:TRIGger:PATTern:QUALifier

N (see [page 1384](#))

Command Syntax :TRIGger:PATTern:QUALifier <qualifier>

<qualifier> ::= {ENTERed | GREaterthan | LESSthan | INRange | OUTRange
| TIMEout}

The :TRIGger:PATTern:QUALifier command qualifies when the trigger occurs:

- ENTERed – when the pattern is entered.
- LESSthan – when the pattern is present for less than a time value.
- GREaterthan – when the pattern is present for greater than a time value. The trigger occurs when the pattern exits (not when the GREaterthan time value is exceeded).
- TIMEout – when the pattern is present for greater than a time value. In this case, the trigger occurs when the GREaterthan time value is exceeded (not when the pattern exits).
- INRange – when the pattern is present for a time within a range of values.
- OUTRange – when the pattern is present for a time outside of range of values.

Pattern durations are evaluated using a timer. The timer starts on the last edge that makes the pattern (logical AND) true. Except when the TIMEout qualifier is selected, the trigger occurs on the first edge that makes the pattern false, provided the time qualifier criteria has been met.

Set the GREaterthan qualifier value with the :TRIGger:PATTern:GREaterthan command.

Set the LESSthan qualifier value with the :TRIGger:PATTern:LESSthan command.

Set the INRange and OUTRange qualifier values with the :TRIGger:PATTern:RANGE command.

Set the TIMEout qualifier value with the :TRIGger:PATTern:GREaterthan command.

Query Syntax :TRIGger:PATTern:QUALifier?

The :TRIGger:PATTern:QUALifier? query returns the trigger duration qualifier.

Return Format <qualifier><NL>

- See Also**
- ["Introduction to :TRIGger Commands"](#) on page 1097
 - [":TRIGger:PATTern:GREaterthan"](#) on page 1152
 - [":TRIGger:PATTern:LESSthan"](#) on page 1153
 - [":TRIGger:PATTern:RANGE"](#) on page 1155

:TRIGger:RUNT Commands

Table 149: :TRIGger:RUNT Commands Summary

Command	Query	Options and Query Returns
:TRIGger:RUNT:POLarity <polarity> (see page 1157)	:TRIGger:RUNT:POLarity? (see page 1157)	<polarity> ::= {POSitive NEGative EITHer}
:TRIGger:RUNT:QUALifier <qualifier> (see page 1158)	:TRIGger:RUNT:QUALifier? (see page 1158)	<qualifier> ::= {GREaterthan LESSthan NONE}
:TRIGger:RUNT:SOURce <source> (see page 1159)	:TRIGger:RUNT:SOURce? (see page 1159)	<source> ::= CHANnel<n> <n> ::= 1 to (# analog channels) in NR1 format
:TRIGger:RUNT:TIME <time>[suffix] (see page 1160)	:TRIGger:RUNT:TIME? (see page 1160)	<time> ::= floating-point number in NR3 format [suffix] ::= {s ms us ns ps}

:TRIGger:RUNT:POLarity

N (see [page 1384](#))

Command Syntax :TRIGger:RUNT:POLarity <polarity>
 <polarity> ::= {POSitive | NEGative | EITHer}

The :TRIGger:RUNT:POLarity command sets the polarity for the runt trigger:

- POSitive – positive runt pulses.
- NEGative – negative runt pulses.
- EITHer – either positive or negative runt pulses.

Query Syntax :TRIGger:RUNT:POLarity?

The :TRIGger:RUNT:POLarity? query returns the runt trigger polarity.

Return Format <polarity><NL>
 <polarity> ::= {POS | NEG | EITH}

- See Also**
- ["Introduction to :TRIGger Commands"](#) on page 1097
 - [":TRIGger:MODE"](#) on page 1106
 - [":TRIGger:LEVel:HIGH"](#) on page 1104
 - [":TRIGger:LEVel:LOW"](#) on page 1105
 - [":TRIGger:RUNT:SOURce"](#) on page 1159

:TRIGger:RUNT:QUALifier

N (see [page 1384](#))

Command Syntax :TRIGger:RUNT:QUALifier <qualifier>

<qualifier> ::= {GREATERthan | LESSthan | NONE}

The :TRIGger:RUNT:QUALifier command selects the qualifier used for specifying runt pulse widths:

- GREATERthan – triggers on runt pulses whose width is greater than the :TRIGger:RUNT:TIME.
- LESSthan – triggers on runt pulses whose width is less than the :TRIGger:RUNT:TIME.
- NONE – triggers on runt pulses of any width.

Query Syntax :TRIGger:RUNT:QUALifier?

The :TRIGger:RUNT:QUALifier? query returns the runt trigger qualifier setting.

Return Format <qualifier><NL>

<qualifier> ::= {GRE | LESS NONE}

- See Also**
- ["Introduction to :TRIGger Commands"](#) on page 1097
 - [":TRIGger:MODE"](#) on page 1106
 - [":TRIGger:RUNT:TIME"](#) on page 1160

:TRIGger:RUNT:SOURce

N (see [page 1384](#))

Command Syntax :TRIGger:RUNT:SOURce <source>

<source> ::= CHANnel<n>

<n> ::= 1 to (# analog channels) in NR1 format

The :TRIGger:RUNT:SOURce command selects the channel used to produce the trigger.

Query Syntax :TRIGger:RUNT:SOURce?

The :TRIGger:RUNT:SOURce? query returns the current runt trigger source.

Return Format <source><NL>

<source> ::= CHAN<n>

- See Also**
- ["Introduction to :TRIGger Commands"](#) on page 1097
 - [":TRIGger:RUNT:POLarity"](#) on page 1157

:TRIGger:RUNT:TIME

N (see [page 1384](#))

Command Syntax :TRIGger:RUNT:TIME <time>[suffix]
 <time> ::= floating-point number in NR3 format
 [suffix] ::= {s | ms | us | ns | ps}

When triggering on runt pulses whose width is greater than or less than a certain value (see :TRIGger:RUNT:QUALifier), the :TRIGger:RUNT:TIME command specifies the time used with the qualifier.

Query Syntax :TRIGger:RUNT:TIME?

The :TRIGger:RUNT:TIME? query returns the current runt pulse qualifier time setting.

Return Format <time><NL>
 <time> ::= floating-point number in NR3 format

- See Also**
- ["Introduction to :TRIGger Commands"](#) on page 1097
 - [":TRIGger:RUNT:QUALifier"](#) on page 1158

:TRIGger:SHOLd Commands

Table 150: :TRIGger:SHOLd Commands Summary

Command	Query	Options and Query Returns
:TRIGger:SHOLd:SLOPe <slope> (see page 1162)	:TRIGger:SHOLd:SLOPe? (see page 1162)	<slope> ::= {NEGative POSitive}
:TRIGger:SHOLd:SOURce :CLOCK <source> (see page 1163)	:TRIGger:SHOLd:SOURce :CLOCK? (see page 1163)	<source> ::= {CHANnel<n> DIGital<d>} <n> ::= 1 to (# analog channels) in NR1 format <d> ::= 0 to (# digital channels - 1) in NR1 format
:TRIGger:SHOLd:SOURce :DATA <source> (see page 1164)	:TRIGger:SHOLd:SOURce :DATA? (see page 1164)	<source> ::= {CHANnel<n> DIGital<d>} <n> ::= 1 to (# analog channels) in NR1 format <d> ::= 0 to (# digital channels - 1) in NR1 format
:TRIGger:SHOLd:TIME:H OLD <time>[suffix] (see page 1165)	:TRIGger:SHOLd:TIME:H OLD? (see page 1165)	<time> ::= floating-point number in NR3 format [suffix] ::= {s ms us ns ps}
:TRIGger:SHOLd:TIME:S ETup <time>[suffix] (see page 1166)	:TRIGger:SHOLd:TIME:S ETup? (see page 1166)	<time> ::= floating-point number in NR3 format [suffix] ::= {s ms us ns ps}

:TRIGger:SHOLd:SLOPe

N (see [page 1384](#))

Command Syntax :TRIGger:SHOLd:SLOPe <slope>

<slope> ::= {NEGative | POSitive}

The :TRIGger:SHOLd:SLOPe command specifies whether the rising edge or the falling edge of the clock signal is used.

Query Syntax :TRIGger:SHOLd:SLOPe?

The :TRIGger:SHOLd:SLOPe? query returns the current rising or falling edge setting.

Return Format <slope><NL>

<slope> ::= {NEG | POS}

- See Also**
- ["Introduction to :TRIGger Commands"](#) on page 1097
 - [":TRIGger:MODE"](#) on page 1106
 - [":TRIGger:SHOLd:SOURce:CLOCK"](#) on page 1163
 - [":TRIGger:SHOLd:SOURce:DATA"](#) on page 1164

:TRIGger:SHOLd:SOURce:CLOCK

N (see [page 1384](#))

Command Syntax :TRIGger:SHOLd:SOURce:CLOCK <source>

<source> ::= {CHANnel<n> | DIGital<d>}

<n> ::= 1 to (# analog channels) in NR1 format

<d> ::= 0 to (# digital channels - 1) in NR1 format

The :TRIGger:SHOLd:SOURce:CLOCK command selects the input channel probing the clock signal.

Query Syntax :TRIGger:SHOLd:SOURce:CLOCK?

The :TRIGger:SHOLd:SOURce:CLOCK? query returns the currently set clock signal source.

Return Format <source><NL>

<source> ::= {CHAN<n> | DIG<d>}

- See Also**
- ["Introduction to :TRIGger Commands"](#) on page 1097
 - [":TRIGger:MODE"](#) on page 1106
 - [":TRIGger:SHOLd:SLOPe"](#) on page 1162

:TRIGger:SHOLd:SOURce:DATA

N (see [page 1384](#))

Command Syntax :TRIGger:SHOLd:SOURce:DATA <source>

<source> ::= {CHANnel<n> | DIGital<d>}

<n> ::= 1 to (# analog channels) in NR1 format

<d> ::= 0 to (# digital channels - 1) in NR1 format

The :TRIGger:SHOLd:SOURce:DATA command selects the input channel probing the data signal.

Query Syntax :TRIGger:SHOLd:SOURce:DATA?

The :TRIGger:SHOLd:SOURce:DATA? query returns the currently set data signal source.

Return Format <source><NL>

<source> ::= {CHAN<n> | DIG<d>}

- See Also**
- ["Introduction to :TRIGger Commands"](#) on page 1097
 - [":TRIGger:MODE"](#) on page 1106
 - [":TRIGger:SHOLd:SLOPe"](#) on page 1162

:TRIGger:SHOLd:TIME:HOLD

N (see [page 1384](#))

Command Syntax :TRIGger:SHOLd:TIME:HOLD <time>[suffix]
 <time> ::= floating-point number in NR3 format
 [suffix] ::= {s | ms | us | ns | ps}

The :TRIGger:SHOLd:TIME:HOLD command sets the hold time.

Query Syntax :TRIGger:SHOLd:TIME:HOLD?

The :TRIGger:SHOLd:TIME:HOLD? query returns the currently specified hold time.

Return Format <time><NL>
 <time> ::= floating-point number in NR3 format

See Also • ["Introduction to :TRIGger Commands"](#) on page 1097

:TRIGger:SHOLd:TIME:SETup

N (see [page 1384](#))

Command Syntax :TRIGger:SHOLd:TIME:SETup <time>[suffix]
 <time> ::= floating-point number in NR3 format
 [suffix] ::= {s | ms | us | ns | ps}

The :TRIGger:SHOLd:TIME:SETup command sets the setup time.

Query Syntax :TRIGger:SHOLd:TIME:SETup?

The :TRIGger:SHOLd:TIME:SETup? query returns the currently specified setup time.

Return Format <time><NL>
 <time> ::= floating-point number in NR3 format

See Also • ["Introduction to :TRIGger Commands"](#) on page 1097

:TRIGger:TRANSition Commands

The :TRIGger:TRANSition commands set the rise/fall time trigger options.

Table 151 :TRIGger:TRANSition Commands Summary

Command	Query	Options and Query Returns
:TRIGger:TRANSition:QUALifier <qualifier> (see page 1168)	:TRIGger:TRANSition:QUALifier? (see page 1168)	<qualifier> ::= {GREATERthan LESSthan}
:TRIGger:TRANSition:SLOPe <slope> (see page 1169)	:TRIGger:TRANSition:SLOPe? (see page 1169)	<slope> ::= {NEGative POSitive}
:TRIGger:TRANSition:SOURce <source> (see page 1170)	:TRIGger:TRANSition:SOURce? (see page 1170)	<source> ::= CHANNEL<n> <n> ::= 1 to (# analog channels) in NR1 format
:TRIGger:TRANSition:TIME <time>[suffix] (see page 1171)	:TRIGger:TRANSition:TIME? (see page 1171)	<time> ::= floating-point number in NR3 format [suffix] ::= {s ms us ns ps}

:TRIGger:TRANSition:QUALifier

N (see [page 1384](#))

Command Syntax :TRIGger:TRANSition:QUALifier <qualifier>
 <qualifier> ::= {GREaterthan | LESSthan}

The :TRIGger:TRANSition:QUALifier command specifies whether you are looking for rise/fall times greater than or less than a certain time value. The time value is set using the :TRIGger:TRANSition:TIME command.

Query Syntax :TRIGger:TRANSition:QUALifier?

The :TRIGger:TRANSition:QUALifier? query returns the current rise/fall time trigger qualifier setting.

Return Format <qualifier><NL>
 <qualifier> ::= {GRE | LESS}

- See Also**
- ["Introduction to :TRIGger Commands"](#) on page 1097
 - [":TRIGger:TRANSition:TIME"](#) on page 1171
 - [":TRIGger:MODE"](#) on page 1106

:TRIGger:TRANSition:SLOPe

N (see [page 1384](#))

Command Syntax :TRIGger:TRANSition:SLOPe <slope>
 <slope> ::= {NEGative | POSitive}

The :TRIGger:TRANSition:SLOPe command specifies a POSitive rising edge or a NEGative falling edge.

Query Syntax :TRIGger:TRANSition:SLOPe?

The :TRIGger:TRANSition:SLOPe? query returns the current rise/fall time trigger slope setting.

Return Format <slope><NL>
 <slope> ::= {NEG | POS}

- See Also**
- ["Introduction to :TRIGger Commands"](#) on page 1097
 - [":TRIGger:MODE"](#) on page 1106
 - [":TRIGger:TRANSition:SOURce"](#) on page 1170

:TRIGger:TRANSition:SOURce

N (see [page 1384](#))

Command Syntax :TRIGger:TRANSition:SOURce <source>

<source> ::= CHANnel<n>

<n> ::= 1 to (# analog channels) in NR1 format

The :TRIGger:TRANSition:SOURce command selects the channel used to produce the trigger.

Query Syntax :TRIGger:TRANSition:SOURce?

The :TRIGger:TRANSition:SOURce? query returns the current transition trigger source.

Return Format <source><NL>

<source> ::= CHAN<n>

- See Also**
- ["Introduction to :TRIGger Commands"](#) on page 1097
 - [":TRIGger:MODE"](#) on page 1106
 - [":TRIGger:TRANSition:SLOPe"](#) on page 1169

:TRIGger:TRANSition:TIME

N (see [page 1384](#))

Command Syntax :TRIGger:TRANSition:TIME <time>[suffix]
 <time> ::= floating-point number in NR3 format
 [suffix] ::= {s | ms | us | ns | ps}

The :TRIGger:TRANSition:TIME command sets the time value for rise/fall time triggers. You also use the :TRIGger:TRANSition:QUALifier command to specify whether you are triggering on times greater than or less than this time value.

Query Syntax :TRIGger:TRANSition:TIME?

The :TRIGger:TRANSition:TIME? query returns the current rise/fall time trigger time value.

Return Format <time><NL>
 <time> ::= floating-point number in NR3 format

- See Also**
- ["Introduction to :TRIGger Commands"](#) on page 1097
 - [":TRIGger:TRANSition:QUALifier"](#) on page 1168

:TRIGger:TV Commands

Table 152: :TRIGger:TV Commands Summary

Command	Query	Options and Query Returns
:TRIGger:TV:LINE <line number> (see page 1173)	:TRIGger:TV:LINE? (see page 1173)	<line number> ::= integer in NR1 format
:TRIGger:TV:MODE <tv mode> (see page 1174)	:TRIGger:TV:MODE? (see page 1174)	<tv mode> ::= {FIELD1 FIELD2 AFIELDS ALINES LINE LFIELD1 LFIELD2 LALTERNATE}
:TRIGger:TV:POLarity <polarity> (see page 1175)	:TRIGger:TV:POLarity? (see page 1175)	<polarity> ::= {POSitive NEGative}
:TRIGger:TV:SOURce <source> (see page 1176)	:TRIGger:TV:SOURce? (see page 1176)	<source> ::= {CHANnel<n>} <n> ::= 1 to (# analog channels) in NR1 format
:TRIGger:TV:STANdard <standard> (see page 1177)	:TRIGger:TV:STANdard? (see page 1177)	<standard> ::= {NTSC PAL PALM SECam} <standard> ::= {GENeric {P480L60HZ P480} {P720L60HZ P720} {P1080L24HZ P1080} P1080L25HZ P1080L50HZ P1080L60HZ {I1080L50HZ I1080 I1080L60HZ} with extended video triggering license
:TRIGger:TV:UDTV:ENUM ber <count> (see page 1178)	:TRIGger:TV:UDTV:ENUM ber? (see page 1178)	<count> ::= edge number in NR1 format
:TRIGger:TV:UDTV:HSYN c {{0 OFF} {1 ON}} (see page 1179)	:TRIGger:TV:UDTV:HSYN c? (see page 1179)	{0 1}
:TRIGger:TV:UDTV:HTIM e <time> (see page 1180)	:TRIGger:TV:UDTV:HTIM e? (see page 1180)	<time> ::= seconds in NR3 format
:TRIGger:TV:UDTV:PGTH an <min_time> (see page 1181)	:TRIGger:TV:UDTV:PGTH an? (see page 1181)	<min_time> ::= seconds in NR3 format

:TRIGger:TV:LINE

N (see [page 1384](#))

Command Syntax :TRIGger:TV:LINE <line_number>

<line_number> ::= integer in NR1 format

The :TRIGger:TV:LINE command allows triggering on a specific line of video. The line number limits vary with the standard and mode, as shown in the following table.

Table 153 TV Trigger Line Number Limits

TV Standard	Mode				
	LINE	LField1	LField2	LALternate	VERTical
NTSC		1 to 263	1 to 262	1 to 262	
PAL		1 to 313	314 to 625	1 to 312	
PAL-M		1 to 263	264 to 525	1 to 262	
SECAM		1 to 313	314 to 625	1 to 312	
GENERIC		1 to 1024	1 to 1024		1 to 1024
P480L60HZ	1 to 525				
P720L60HZ	1 to 750				
P1080L24HZ	1 to 1125				
P1080L25HZ	1 to 1125				
P1080L50HZ	1 to 1125				
P1080L60HZ	1 to 1125				
I1080L50HZ	1 to 1125				
I1080L60HZ	1 to 1125				

Query Syntax :TRIGger:TV:LINE?

The :TRIGger:TV:LINE? query returns the current TV trigger line number setting.

Return Format <line_number><NL>

<line_number> ::= integer in NR1 format

- See Also**
- ["Introduction to :TRIGger Commands"](#) on page 1097
 - [":TRIGger:TV:STANdard"](#) on page 1177
 - [":TRIGger:TV:MODE"](#) on page 1174

:TRIGger:TV:MODE

N (see [page 1384](#))

Command Syntax :TRIGger:TV:MODE <mode>

```
<mode> ::= {FIEld1 | FIEld2 | AFIElds | ALINes | LINE | LFIeld1
            | LFIeld2 | LALTernate}
```

The :TRIGger:TV:MODE command selects the TV trigger mode and field. The LALTernate parameter is not available when :TRIGger:TV:STANdard is GENeric.

Old forms for <mode> are accepted:

<mode>	Old Forms Accepted
FIEld1	F1
FIEld2	F2
AFIElds	ALLFields, ALLFLDS
ALINes	ALLLines
LFIeld1	LINEF1, LINEFIELD1
LFIeld2	LINEF2, LINEFIELD2
LALTernate	LINEAlt

Query Syntax :TRIGger:TV:MODE?

The :TRIGger:TV:MODE? query returns the TV trigger mode.

Return Format <value><NL>

```
<value> ::= {FIE1 | FIE2 | AFI | ALIN | LINE | LFI1 | LFI2 | LALT}
```

- See Also**
- ["Introduction to :TRIGger Commands"](#) on page 1097
 - [":TRIGger:TV:STANdard"](#) on page 1177
 - [":TRIGger:MODE"](#) on page 1106

:TRIGger:TV:POLarity

N (see [page 1384](#))

Command Syntax :TRIGger:TV:POLarity <polarity>
<polarity> ::= {POSitive | NEGative}

The :TRIGger:TV:POLarity command sets the polarity for the TV trigger.

Query Syntax :TRIGger:TV:POLarity?

The :TRIGger:TV:POLarity? query returns the TV trigger polarity.

Return Format <polarity><NL>
<polarity> ::= {POS | NEG}

- See Also**
- ["Introduction to :TRIGger Commands"](#) on page 1097
 - [":TRIGger:MODE"](#) on page 1106
 - [":TRIGger:TV:SOURce"](#) on page 1176

:TRIGger:TV:SOURce

N (see [page 1384](#))

Command Syntax :TRIGger:TV:SOURce <source>

<source> ::= {CHANnel<n>}

<n> ::= 1 to (# analog channels) in NR1 format

The :TRIGger:TV:SOURce command selects the channel used to produce the trigger.

Query Syntax :TRIGger:TV:SOURce?

The :TRIGger:TV:SOURce? query returns the current TV trigger source.

Return Format <source><NL>

<source> ::= {CHAN<n>}

- See Also**
- ["Introduction to :TRIGger Commands"](#) on page 1097
 - [":TRIGger:MODE"](#) on page 1106
 - [":TRIGger:TV:POLarity"](#) on page 1175

Example Code • ["Example Code"](#) on page 1126

:TRIGger:TV:STANdard

N (see [page 1384](#))

Command Syntax :TRIGger:TV:STANdard <standard>

```
<standard> ::= {GENeric | NTSC | PALM | PAL | SECam
                | {P480L60HZ | P480} | {P720L60HZ | P720}
                | {P1080L24HZ | P1080} | P1080L25HZ
                | P1080L50HZ | P1080L60HZ
                | {I1080L50HZ | I1080} | I1080L60HZ}
```

The :TRIGger:TV:STANdard command selects the video standard:

- NTSC
- PAL
- PAL-M
- SECAM

With an extended Video triggering license, the oscilloscope additionally supports these standards:

- Generic – GENeric mode is non-interlaced.
- EDTV 480p/60
- HDTV 720p/60
- HDTV 1080p/24
- HDTV 1080p/25
- HDTV 1080i/50
- HDTV 1080i/60

Query Syntax :TRIGger:TV:STANdard?

The :TRIGger:TV:STANdard? query returns the current TV trigger standard setting.

Return Format <standard><NL>

```
<standard> ::= {GEN | NTSC | PALM | PAL | SEC | P480L60HZ | P760L60HZ
                | P1080L24HZ | P1080L25HZ | P1080L50HZ | P1080L60HZ
                | I1080L50HZ | I1080L60HZ}
```

:TRIGger:TV:UDTV:ENUMber

N (see [page 1384](#))

Command Syntax :TRIGger:TV:UDTV:ENUMber <count>

<count> ::= edge number in NR1 format

The :TRIGger:TV:UDTV:ENUMber command specifies the Generic video trigger's Nth edge to trigger on after synchronizing with the vertical sync.

Query Syntax :TRIGger:TV:UDTV:ENUMber?

The :TRIGger:TV:UDTV:ENUMber query returns the edge count setting.

Return Format <count><NL>

<count> ::= edge number in NR1 format

- See Also**
- [":TRIGger:TV:STANdard"](#) on page 1177
 - [":TRIGger:TV:UDTV:PGTHan"](#) on page 1181
 - [":TRIGger:TV:UDTV:HSYNc"](#) on page 1179

:TRIGger:TV:UDTV:HSYNc

N (see [page 1384](#))

Command Syntax :TRIGger:TV:UDTV:HSYNc {{0 | OFF} | {1 | ON}}

The :TRIGger:TV:UDTV:HSYNc command enables or disables the horizontal sync control in the Generic video trigger.

For interleaved video, enabling the HSYNc control and setting the HTIME adjustment to the sync time of the probed video signal allows the ENUMber function to count only lines and not double count during equalization. Additionally, the Field Holdoff can be adjusted so that the oscilloscope triggers once per frame.

Similarly, for progressive video with a tri-level sync, enabling the HSYNc control and setting the HTIME adjustment to the sync time of the probed video signal allows the ENUMber function to count only lines and not double count during vertical sync.

Query Syntax :TRIGger:TV:UDTV:HSYNc?

The :TRIGger:TV:UDTV:HSYNc query returns the horizontal sync control setting.

Return Format {0 | 1}

- See Also**
- [":TRIGger:TV:STANdard"](#) on page 1177
 - [":TRIGger:TV:UDTV:HTIME"](#) on page 1180
 - [":TRIGger:TV:UDTV:ENUMber"](#) on page 1178
 - [":TRIGger:TV:UDTV:PGTHan"](#) on page 1181

:TRIGger:TV:UDTV:HTIME

N (see [page 1384](#))

Command Syntax :TRIGger:TV:UDTV:HTIME <time>

<time> ::= seconds in NR3 format

When the Generic video trigger's horizontal sync control is enabled, the :TRIGger:TV:UDTV:HTIME command sets the minimum time the horizontal sync pulse must be present to be considered valid.

Query Syntax :TRIGger:TV:UDTV:HTIME?

The :TRIGger:TV:UDTV:HTIME query returns the horizontal sync time setting.

Return Format <time><NL>

<time> ::= seconds in NR3 format

- See Also**
- [":TRIGger:TV:STANdard"](#) on page 1177
 - [":TRIGger:TV:UDTV:HSYNc"](#) on page 1179

:TRIGger:TV:UDTV:PGTHan

N (see [page 1384](#))

Command Syntax :TRIGger:TV:UDTV:PGTHan <min_time>
 <min_time> ::= seconds in NR3 format

The :TRIGger:TV:UDTV:PGTHan command specifies the "greater than the sync pulse width" time in the Generic video trigger. This setting allows oscilloscope synchronization to the vertical sync.

Query Syntax :TRIGger:TV:UDTV:PGTHan?

The :TRIGger:TV:UDTV:PGTHan query returns the "greater than the sync pulse width" time setting.

Return Format <min_time><NL>
 <min_time> ::= seconds in NR3 format

- See Also**
- [":TRIGger:TV:STANdard"](#) on page 1177
 - [":TRIGger:TV:UDTV:ENUMber"](#) on page 1178
 - [":TRIGger:TV:UDTV:HSYNc"](#) on page 1179

:TRIGger:USB Commands

Table 154: :TRIGger:USB Commands Summary

Command	Query	Options and Query Returns
:TRIGger:USB:SOURce:D MINus <source> (see page 1183)	:TRIGger:USB:SOURce:D MINus? (see page 1183)	<source> ::= {CHANnel<n> EXTernal} for the DSO models <source> ::= {CHANnel<n> DIGital<d>} for the MSO models <n> ::= 1 to (# analog channels) in NR1 format <d> ::= 0 to (# digital channels - 1) in NR1 format
:TRIGger:USB:SOURce:D PLus <source> (see page 1184)	:TRIGger:USB:SOURce:D PLus? (see page 1184)	<source> ::= {CHANnel<n> EXTernal} for the DSO models <source> ::= {CHANnel<n> DIGital<d>} for the MSO models <n> ::= 1 to (# analog channels) in NR1 format <d> ::= 0 to (# digital channels - 1) in NR1 format
:TRIGger:USB:SPEEd <value> (see page 1185)	:TRIGger:USB:SPEEd? (see page 1185)	<value> ::= {LOW FULL}
:TRIGger:USB:TRIGger <value> (see page 1186)	:TRIGger:USB:TRIGger? (see page 1186)	<value> ::= {SOP EOP ENTersuspend EXITsuspend RESEt}

:TRIGger:USB:SOURce:DMINus

N (see [page 1384](#))

Command Syntax :TRIGger:USB:SOURce:DMINus <source>

<source> ::= {CHANnel<n> | EXTernal} for the DSO models

<source> ::= {CHANnel<n> | DIGital<d>} for the MSO models

<n> ::= 1 to (# analog channels) in NR1 format

<d> ::= 0 to (# digital channels - 1) in NR1 format

The :TRIGger:USB:SOURce:DMINus command sets the source for the USB D-signal.

Query Syntax :TRIGger:USB:SOURce:DMINus?

The :TRIGger:USB:SOURce:DMINus? query returns the current source for the USB D-signal.

Return Format <source><NL>

- See Also**
- ["Introduction to :TRIGger Commands"](#) on page 1097
 - [":TRIGger:MODE"](#) on page 1106
 - [":TRIGger:USB:SOURce:DPLus"](#) on page 1184
 - [":TRIGger:USB:TRIGger"](#) on page 1186

:TRIGger:USB:SOURce:DPLus

N (see [page 1384](#))

Command Syntax :TRIGger:USB:SOURce:DPLus <source>
 <source> ::= {CHANnel<n> | EXTernal} for the DSO models
 <source> ::= {CHANnel<n> | DIGital<d>} for the MSO models
 <n> ::= 1 to (# analog channels) in NR1 format
 <d> ::= 0 to (# digital channels - 1) in NR1 format

The :TRIGger:USB:SOURce:DPLus command sets the source for the USB D+ signal.

Query Syntax :TRIGger:USB:SOURce:DPLus?

The :TRIGger:USB:SOURce:DPLus? query returns the current source for the USB D+ signal.

Return Format <source><NL>

- See Also**
- ["Introduction to :TRIGger Commands"](#) on page 1097
 - [":TRIGger:MODE"](#) on page 1106
 - [":TRIGger:USB:SOURce:DMINus"](#) on page 1183
 - [":TRIGger:USB:TRIGger"](#) on page 1186

:TRIGger:USB:SPEEd

N (see [page 1384](#))

Command Syntax :TRIGger:USB:SPEEd <value>
<value> ::= {LOW | FULL}

The :TRIGger:USB:SPEEd command sets the expected USB signal speed to be Low Speed (1.5 Mb/s) or Full Speed (12 Mb/s).

Query Syntax :TRIGger:USB:SPEEd?

The :TRIGger:USB:SPEEd? query returns the current speed value for the USB signal.

Return Format <value><NL>

- See Also**
- ["Introduction to :TRIGger Commands"](#) on page 1097
 - [":TRIGger:MODE"](#) on page 1106
 - [":TRIGger:USB:SOURce:DMINus"](#) on page 1183
 - [":TRIGger:USB:SOURce:DPLus"](#) on page 1184
 - [":TRIGger:USB:TRIGger"](#) on page 1186

:TRIGger:USB:TRIGger

N (see [page 1384](#))

Command Syntax :TRIGger:USB:TRIGger <value>

<value> ::= {SOP | EOP | ENTersuspend | EXITsuspend | RESet}

The :TRIGger:USB:TRIGger command sets where the USB trigger will occur:

- SOP – Start of packet.
- EOP – End of packet.
- ENTersuspend – Enter suspend state.
- EXITsuspend – Exit suspend state.
- RESet – Reset complete.

Query Syntax :TRIGger:USB:TRIGger?

The :TRIGger:USB:TRIGger? query returns the current USB trigger value.

Return Format <value><NL>

<value> ::= {SOP | EOP | ENTersuspend | EXITsuspend | RESet}

- See Also**
- ["Introduction to :TRIGger Commands"](#) on page 1097
 - [":TRIGger:MODE"](#) on page 1106
 - [":TRIGger:USB:SPEed"](#) on page 1185

:TRIGger:ZONE Commands

Table 155: :TRIGger:ZONE Commands Summary

Command	Query	Options and Query Returns
:TRIGger:ZONE:SOURce <source> (see page 1188)	:TRIGger:ZONE:SOURce? (see page 1188)	<source> ::= {CHANnel<n>} <n> ::= 1 to (# analog channels) in NR1 format
:TRIGger:ZONE:STATe { {0 OFF} {1 ON} } (see page 1189)	:TRIGger:ZONE:STATe? (see page 1189)	{0 1}
:TRIGger:ZONE<n>:MODE <mode> (see page 1190)	:TRIGger:ZONE<n>:MODE ? (see page 1190)	<mode> ::= {INTersect NOTintersect} <n> ::= 1-2 in NR1 format
:TRIGger:ZONE<n>:PLAC ement <width>, <height>, <x_center>, <y_center> (see page 1191)	:TRIGger:ZONE<n>:PLAC ement? (see page 1191)	<width> ::= width of zone in seconds <height> ::= height of zone in volts <x_center> ::= center of zone in seconds <y_center> ::= center of zone in volts <n> ::= 1-2 in NR1 format
n/a	:TRIGger:ZONE<n>:VALi dity? (see page 1192)	<value> ::= {VALid INValid OSCRreen} <n> ::= 1-2 in NR1 format
:TRIGger:ZONE<n>:STAT e { {0 OFF} {1 ON} } (see page 1193)	:TRIGger:ZONE<n>:STAT e? (see page 1193)	{0 1} <n> ::= 1-2 in NR1 format

:TRIGger:ZONE:SOURce

N (see [page 1384](#))

Command Syntax :TRIGger:ZONE:SOURce <source>

<source> ::= {CHANnel<n>}

<n> ::= 1 to (# analog channels) in NR1 format

The :TRIGger:ZONE:SOURce command sets the analog source channel shared by all zones.

Query Syntax :TRIGger:ZONE:SOURce?

The :TRIGger:ZONE:SOURce? query returns the analog source channel specified for zone qualified triggers.

Return Format <source><NL>

<source> ::= {CHAN<n>}

See Also • [":TRIGger:ZONE:STATe"](#) on page 1189

:TRIGger:ZONE:STATe

N (see [page 1384](#))

Command Syntax :TRIGger:ZONE:STATe <on_off>

<on_off> ::= {{0 | OFF} | {1 | ON}}

The :TRIGger:ZONE:STATe command enables or disables the zone qualified trigger feature.

When the zone qualified trigger is on, the zone(s) are actively being used to qualify the trigger.

Note that the :TRIGger:ZONE<n>:STATe setting must also be ON for a zone to be active.

Note that :TRIGger:ZONE:STATe mimics the behavior of the **[Zone]** key on the front panel, and :TRIGger:ZONE<n>:STATe mimics the behavior of the **Zone 1 On** and **Zone 2 On** softkeys. At least one zone's state must be on for the Zone Trigger feature (:TRIGger:ZONE:STATe) to be on. When the states of both individual zones are turned off, Zone Trigger is automatically turned off. In this case, when Zone Trigger is turned back on Zone 1 is forced to on. Otherwise, if at least one zone was on when Zone Trigger was turned off, the same configuration of individual zone on/off states will be restored when Zone Trigger is turned back on.

Query Syntax :TRIGger:ZONE:STATe?

The :TRIGger:ZONE:STATe? query returns whether the zone qualified trigger feature is enabled or disabled.

Return Format <on_off><NL>

<on_off> ::= {0 | 1}

- See Also**
- **":TRIGger:ZONE<n>:STATe"** on page 1193
 - **":TRIGger:ZONE:SOURce"** on page 1188

:TRIGger:ZONE<n>:MODE

N (see [page 1384](#))

Command Syntax :TRIGger:ZONE<n>:MODE <mode>

<mode> ::= {INTersect | NOTintersect}

<n> ::= 1-2 in NR1 format

The :TRIGger:ZONE<n>:MODE command sets the zone qualifying condition for Zone 1 or Zone 2 as either "Must Intersect" or "Must Not Intersect".

Query Syntax :TRIGger:ZONE<n>:MODE?

The :TRIGger:ZONE<n>:MODE? query returns the zone qualifying condition for Zone 1 or Zone 2.

Return Format <mode><NL>

<mode> ::= {INT | NOT}

- See Also**
- [":TRIGger:ZONE<n>:STATe"](#) on page 1193
 - [":TRIGger:ZONE<n>:PLACement"](#) on page 1191
 - [":TRIGger:ZONE<n>:VALidity"](#) on page 1192

:TRIGger:ZONE<n>:PLACement

N (see [page 1384](#))

Command Syntax :TRIGger:ZONE<n>:PLACement <width>, <height>, <x_center>, <y_center>
 <width> ::= width of zone in seconds
 <height> ::= height of zone in volts
 <x_center> ::= center of zone in seconds
 <y_center> ::= center of zone in volts
 <n> ::= 1-2 in NR1 format

The :TRIGger:ZONE<n>:PLACement command sets the size and location of Zone 1 or Zone 2.

No error is returned if the zone is placed off-screen, or if the zones overlap such that Zone 2 becomes invalid. The :TRIGger:ZONE<n>:VALidity? query is used to retrieve this information.

Query Syntax :TRIGger:ZONE<n>:PLACement?

The :TRIGger:ZONE<n>:PLACement? query returns the size and location of Zone 1 or Zone 2.

Return Format <opt><NL>
 <opt> ::= <width>, <height>, <x_center>, <y_center>

- See Also**
- [":TRIGger:ZONE<n>:STATe"](#) on page 1193
 - [":TRIGger:ZONE<n>:MODE"](#) on page 1190
 - [":TRIGger:ZONE<n>:VALidity"](#) on page 1192

:TRIGger:ZONE<n>:VALidity

N (see [page 1384](#))

Query Syntax :TRIGger:ZONE<n>:VALidity?

<n> ::= 1-2 in NR1 format

The :TRIGger:ZONE<n>:VALidity? query returns the validity of Zone 1 or Zone 2.

- INValid is returned (for Zone 2 only) when Zone 1 and Zone 2 overlap and have opposing qualifying conditions (modes). Zone 1 can never be invalid.
- OSCReen (off-screen) is returned when the associated zone is off-screen, and thus not being used to qualify the trigger.
- A zone is valid when it is neither invalid nor off-screen.

The validity of a zone is not affected by the zone's state. For example, a zone can be valid and off. You cannot directly set the validity of a zone.

Return Format <validity><NL>

<validity> ::= {VALid | INValid | OSCReen}

- See Also**
- [":TRIGger:ZONE<n>:STATe"](#) on page 1193
 - [":TRIGger:ZONE<n>:MODE"](#) on page 1190
 - [":TRIGger:ZONE<n>:PLACement"](#) on page 1191

:TRIGger:ZONE<n>:STATe

N (see [page 1384](#))

Command Syntax :TRIGger:ZONE<n>:STATe <on_off>

<n> ::= {1 | 2}

<on_off> ::= {{0 | OFF} | {1 | ON}}

<n> ::= 1-2 in NR1 format

The :TRIGger:ZONE<n>:STATe command sets the state for Zone 1 or Zone 2.

- When a zone's state is on, and the Zone Trigger feature is on (see "[:TRIGger:ZONE:STATe](#)" on page 1189), that zone is actively being used to qualify the trigger if it is not invalid or off-screen (see "[:TRIGger:ZONE<n>:VALidity](#)" on page 1192).
- When the Zone Trigger feature is off, no zones are being used to qualify the trigger, regardless of their individual states.

Note that :TRIGger:ZONE:STATe mimics the behavior of the **[Zone]** key on the front panel, and :TRIGger:ZONE<n>:STATe mimics the behavior of the **Zone 1 On** and **Zone 2 On** softkeys. At least one zone's state must be on for the Zone Trigger feature (:TRIGger:ZONE:STATe) to be on. When the states of both individual zones are turned off, Zone Trigger is automatically turned off. In this case, when Zone Trigger is turned back on Zone 1 is forced to on. Otherwise, if at least one zone was on when Zone Trigger was turned off, the same configuration of individual zone on/off states will be restored when Zone Trigger is turned back on.

Query Syntax :TRIGger:ZONE<n>:STATe?

The :TRIGger:ZONE<n>:STATe? query returns the state of Zone 1 or Zone 2.

Return Format <on_off><NL>

<on_off> ::= {0 | 1}

- See Also**
- "[:TRIGger:ZONE:STATe](#)" on page 1189
 - "[:TRIGger:ZONE<n>:VALidity](#)" on page 1192

34 :WAVeform Commands

Provide access to waveform data. See "[Introduction to :WAVeform Commands](#)" on page 1197.

Table 156 :WAVeform Commands Summary

Command	Query	Options and Query Returns
:WAVeform:BYTeorder <value> (see page 1203)	:WAVeform:BYTeorder? (see page 1203)	<value> ::= {LSBFirst MSBFirst}
n/a	:WAVeform:COUnT? (see page 1204)	<count> ::= an integer from 1 to 65536 in NR1 format
n/a	:WAVeform:DATA? (see page 1205)	<binary block length bytes>, <binary data> For example, to transmit 1000 bytes of data, the syntax would be: #800001000<1000 bytes of data><NL> 8 is the number of digits that follow 00001000 is the number of bytes to be transmitted <1000 bytes of data> is the actual data
:WAVeform:FORMat <value> (see page 1207)	:WAVeform:FORMat? (see page 1207)	<value> ::= {WORD BYTE ASCII}
:WAVeform:POINts <# points> (see page 1208)	:WAVeform:POINts? (see page 1208)	<# points> ::= {100 250 500 1000 <points_mode>} if waveform points mode is NORMAl <# points> ::= {100 250 500 1000 2000 ... 8000000 in 1-2-5 sequence <points_mode>} if waveform points mode is MAXimum or RAW <points_mode> ::= {NORMAl MAXimum RAW}

Table 156: WAVEform Commands Summary (continued)

Command	Query	Options and Query Returns
:WAVEform:POINTs:MODE <points_mode> (see page 1210)	:WAVEform:POINTs:MODE ? (see page 1210)	<points_mode> ::= {NORMAL MAXimum RAW}
n/a	:WAVEform:PREAmble? (see page 1212)	<preamble_block> ::= <format NR1>, <type NR1>, <points NR1>, <count NR1>, <xincrement NR3>, <xorigin NR3>, <xreference NR1>, <yincrement NR3>, <yorigin NR3>, <yreference NR1> <format> ::= an integer in NR1 format: <ul style="list-style-type: none"> • 0 for BYTE format • 1 for WORD format • 2 for ASCii format <type> ::= an integer in NR1 format: <ul style="list-style-type: none"> • 0 for NORMAl type • 1 for PEAK detect type • 3 for AVERAge type • 4 for HRESolution type <count> ::= Average count, or 1 if PEAK detect type or NORMAl; an integer in NR1 format
n/a	:WAVEform:SEGmented:C OUNT? (see page 1215)	<count> ::= an integer from 2 to 1000 in NR1 format (with Option SGM)
n/a	:WAVEform:SEGmented:T TAG? (see page 1216)	<time_tag> ::= in NR3 format (with Option SGM)
:WAVEform:SOURce <source> (see page 1217)	:WAVEform:SOURce? (see page 1217)	<source> ::= {CHANnel<n> FUNctIon<m> MATH<m> FFT SBUS} for DSO models <source> ::= {CHANnel<n> POD{1 2} BUS{1 2} FUNctIon<m> MATH<m> FFT SBUS} for MSO models <n> ::= 1 to (# analog channels) in NR1 format <m> ::= 1 to (# math functions) in NR1 format
:WAVEform:SOURce:SUBS ource <subsource> (see page 1221)	:WAVEform:SOURce:SUBS ource? (see page 1221)	<subsource> ::= {{SUB0 RX MOSI} {SUB1 TX MISO}}

Table 156 :WAVEform Commands Summary (continued)

Command	Query	Options and Query Returns
n/a	:WAVEform:TYPE? (see page 1222)	<return_mode> ::= {NORM PEAK AVER HRES}
:WAVEform:UNSigned {0 OFF} {1 ON} (see page 1223)	:WAVEform:UNSigned? (see page 1223)	{0 1}
:WAVEform:VIEW <view> (see page 1224)	:WAVEform:VIEW? (see page 1224)	<view> ::= {MAIN}
n/a	:WAVEform:XINCrement? (see page 1225)	<return_value> ::= x-increment in the current preamble in NR3 format
n/a	:WAVEform:XORigin? (see page 1226)	<return_value> ::= x-origin value in the current preamble in NR3 format
n/a	:WAVEform:XREFerence? (see page 1227)	<return_value> ::= 0 (x-reference value in the current preamble in NR1 format)
n/a	:WAVEform:YINCrement? (see page 1228)	<return_value> ::= y-increment value in the current preamble in NR3 format
n/a	:WAVEform:YORigin? (see page 1229)	<return_value> ::= y-origin in the current preamble in NR3 format
n/a	:WAVEform:YREFerence? (see page 1230)	<return_value> ::= y-reference value in the current preamble in NR1 format

Introduction to :WAVEform Commands The WAVEform subsystem is used to transfer data to a controller from the oscilloscope waveform memories. The queries in this subsystem will only operate when the channel selected by :WAVEform:SOURce is on.

Waveform Data and Preamble

The waveform record is actually contained in two portions: the preamble and waveform data. The waveform record must be read from the oscilloscope by the controller using two separate commands, :WAVEform:DATA (see [page 1205](#)) and :WAVEform:PREAmble (see [page 1212](#)). The waveform data is the actual data acquired for each point in the specified source. The preamble contains the information for interpreting the waveform data, which includes the number of points acquired, the format of acquired data, and the type of acquired data. The preamble also contains the X and Y increments, origins, and references for the acquired data, so that word and byte data can be translated to time and voltage values.

Data Acquisition Types

There are four types of waveform acquisitions that can be selected for analog channels with the :ACQUIRE:TYPE command (see [page 265](#)): NORMal, AVERage, PEAK, and HRESolution. Digital channels are always acquired using NORMal. When the data is acquired using the :DIGitize command (see [page 225](#)) or :RUN command (see [page 246](#)), the data is placed in the channel buffer of the specified source.

Once you have acquired data with the :DIGitize command, the instrument is stopped. If the instrument is restarted (via the programming interface or the front panel), or if any instrument setting is changed, the data acquired with the :DIGitize command may be overwritten. You should first acquire the data with the :DIGitize command, then immediately read the data with the :WAVEform:DATA? query (see [page 1205](#)) before changing any instrument setup.

A waveform record consists of either all of the acquired points or a subset of the acquired points. The number of points acquired may be queried using :ACQUIRE:POINTS? (see [page 258](#)).

Helpful Hints:

The number of points transferred to the computer is controlled using the :WAVEform:POINTS command (see [page 1208](#)). If :WAVEform:POINTS MAXimum is specified and the instrument is not running (stopped), all of the points that are displayed are transferred. This can be as many as 4,000,000 in some operating modes or as many as 8,000,000 for a digital channel on the mixed signal oscilloscope. Fewer points may be specified to speed data transfers and minimize controller analysis time. The :WAVEform:POINTS may be varied even after data on a channel is acquired. However, this decimation may result in lost pulses and transitions. The number of points selected for transfer using :WAVEform:POINTS must be an even divisor of 1,000 or be set to MAXimum. :WAVEform:POINTS determines the increment between time buckets that will be transferred. If POINTs = MAXimum, the data cannot be decimated. For example:

- :WAVEform:POINTS 1000 – returns time buckets 0, 1, 2, 3, 4 ..., 999.
- :WAVEform:POINTS 500 – returns time buckets 0, 2, 4, 6, 8 ..., 998.
- :WAVEform:POINTS 250 – returns time buckets 0, 4, 8, 12, 16 ..., 996.
- :WAVEform:POINTS 100 – returns time buckets 0, 10, 20, 30, 40 ..., 990.

Analog Channel Data

NORMal Data

Normal data consists of the last data point (hit) in each time bucket. This data is transmitted over the programming interface in a linear fashion starting with time bucket 0 and going through time bucket $n - 1$, where n is the number returned by the :WAVEform:POINTS? query (see [page 1208](#)). Only the magnitude values of

each data point are transmitted. The first voltage value corresponds to the first time bucket on the left side of the screen and the last value corresponds to the next-to-last time bucket on the right side of the screen. Time buckets without data return 0. The time values for each data point correspond to the position of the data point in the data array. These time values are not transmitted.

AVERage Data

AVERage data consists of the average of the first n hits in a time bucket, where n is the value returned by the :ACQUIRE:COUNT query (see [page 256](#)). Time buckets that have fewer than n hits return the average of the data they do have. If a time bucket does not have any data in it, it returns 0.

This data is transmitted over the interface linearly, starting with time bucket 0 and proceeding through time bucket $n-1$, where n is the number returned by the :WAVeform:POINTS? query (see [page 1208](#)). The first value corresponds to a point at the left side of the screen and the last value corresponds to one point away from the right side of the screen. The maximum number of points that can be returned in average mode is 1000 unless ACQUIRE:COUNT has been set to 1.

PEAK Data

Peak detect display mode is used to detect glitches for time base settings of 500 us/div and slower. In this mode, the oscilloscope can sample more data than it can store and display. So, when peak detect is turned on, the oscilloscope scans through the extra data, picks up the minimum and maximum for each time bucket, then stores the data in an array. Each time bucket contains two data sample.

The array is transmitted over the interface bus linearly, starting with time bucket 0 proceeding through time bucket $n-1$, where n is the number returned by the :WAVeform:POINTS? query (see [page 1208](#)). In each time bucket, two values are transmitted, first the minimum, followed by the maximum. The first pair of values corresponds to the time bucket at the leftmost side of the screen. The last pair of values corresponds to the time bucket at the far right side of the screen. In :ACQUIRE:TYPE PEAK mode (see [page 265](#)), the value returned by the :WAVeform:XINCREMENT query (see [page 1225](#)) should be doubled to find the time difference between the min-max pairs.

HRESolution Data

The high resolution (*smoothing*) mode is used to reduce noise at slower sweep speeds where the digitizer samples faster than needed to fill memory for the displayed time range.

Data Conversion

Word or byte data sent from the oscilloscope must be scaled for useful interpretation. The values used to interpret the data are the X and Y references, X and Y origins, and X and Y increments. These values are read from the waveform preamble. Each channel has its own waveform preamble.

In converting a data value to a voltage value, the following formula is used:

$$\text{voltage} = [(\text{data value} - \text{yreference}) * \text{yincrement}] + \text{yorigin}$$

If the :WAVEform:FORMat data format is ASCII (see [page 1207](#)), the data values are converted internally and sent as floating point values separated by commas.

In converting a data value to time, the time value of a data point can be determined by the position of the data point. For example, the fourth data point sent with :WAVEform:XORigin = 16 ns, :WAVEform:XREFerence = 0, and :WAVEform:XINCrement = 2 ns, can be calculated using the following formula:

$$\text{time} = [(\text{data point number} - \text{xreference}) * \text{xincrement}] + \text{xorigin}$$

This would result in the following calculation for time bucket 3:

$$\text{time} = [(3 - 0) * 2 \text{ ns}] + 16 \text{ ns} = 22 \text{ ns}$$

In :ACQUIRE:TYPE PEAK mode (see [page 265](#)), because data is acquired in max-min pairs, modify the previous time formula to the following:

$$\text{time} = [(\text{data pair number} - \text{xreference}) * \text{xincrement} * 2] + \text{xorigin}$$

Data Format for Transfer

There are three formats for transferring waveform data over the interface: BYTE, WORD and ASCII (see [":WAVEform:FORMat"](#) on page 1207). BYTE, WORD and ASCII formatted waveform records are transmitted using the arbitrary block program data format specified in IEEE 488.2.

When you use the block data format, the ASCII character string "#8<DD...D>" is sent prior to sending the actual data. The 8 indicates how many Ds follow. The Ds are ASCII numbers that indicate how many data bytes follow.

For example, if 1000 points will be transferred, and the WORD format was specified, the block header "#800001000" would be sent. The 8 indicates that eight length bytes follow, and 00001000 indicates that 1000 binary data bytes follow.

Use the :WAVEform:UNSIGNED command (see [page 1223](#)) to control whether data values are sent as unsigned or signed integers. This command can be used to match the instrument's internal data type to the data type used by the programming language. This command has no effect if the data format is ASCII.

Data Format for Transfer - ASCII format

The ASCII format (see [":WAVEform:FORMat"](#) on page 1207) provides access to the waveform data as real Y-axis values without using Y origin, Y reference, and Y increment to convert the binary data. Values are transferred as ASCII digits in floating point format separated by commas. In ASCII format, holes are represented by the value 9.9e+37. The setting of :WAVEform:BYTEorder (see [page 1203](#)) and :WAVEform:UNSIGNED (see [page 1223](#)) have no effect when the format is ASCII.

Data Format for Transfer - WORD format

WORD format (see **":WAVEform:FORMat"** on page 1207) provides 16-bit access to the waveform data. In the WORD format, the number of data bytes is twice the number of data points. The number of data points is the value returned by the :WAVEform:POINts? query (see **page 1208**). If the data intrinsically has less than 16 bits of resolution, the data is left-shifted to provide 16 bits of resolution and the least significant bits are set to 0. Currently, the greatest intrinsic resolution of any data is 12 bits, so at least the lowest 4 bits of data will be 0. If there is a hole in the data, the hole is represented by a 16 bit value equal to 0.

Use :WAVEform:BYTeorder (see **page 1203**) to determine if the least significant byte or most significant byte is to be transferred first. The :BYTeorder command can be used to alter the transmit sequence to match the storage sequence of an integer in the programming language being used.

Data Format for Transfer - BYTE format

The BYTE format (see **":WAVEform:FORMat"** on page 1207) allows 8-bit access to the waveform data. If the data intrinsically has more than 8 bits of resolution (averaged data), the data is right-shifted (truncated) to fit into 8 bits. If there is a hole in the data, the hole is represented by a value of 0. The BYTE-formatted data transfers over the programming interface faster than ASCII or WORD-formatted data, because in ASCII format, as many as 13 bytes per point are transferred, in BYTE format one byte per point is transferred, and in WORD format two bytes per point are transferred.

The :WAVEform:BYTeorder command (see **page 1203**) has no effect when the data format is BYTE.

Digital Channel Data (MSO models only)

The waveform record for digital channels is similar to that of analog channels. The main difference is that the data points represent either DIGital0,...,7 (POD1), DIGital8,...,15 (POD2), or any grouping of digital channels (BUS1 or BUS2).

For digital channels, :WAVEform:UNSigned (see **page 1223**) must be set to ON.

Digital Channel POD Data Format

Data for digital channels is only available in groups of 8 bits (Pod1 = D0 - D7, Pod2 = D8 - D15). The bytes are organized as:

:WAVEform:SOURce	Bit 7	Bit 6	Bit 5	Bit 4	Bit 3	Bit 2	Bit 1	Bit 0
POD1	D7	D6	D5	D4	D3	D2	D1	D0
POD2	D15	D14	D13	D12	D11	D10	D9	D8

If the :WAVEform:FORMat is WORD (see [page 1207](#)) is WORD, every other data byte will be 0. The setting of :WAVEform:BYTeorder (see [page 1203](#)) controls which byte is 0.

If a digital channel is not displayed, its bit value in the pod data byte is not defined.

Digital Channel BUS Data Format

Digital channel BUS definitions can include any or all of the digital channels. Therefore, data is always returned as 16-bit values. :BUS commands (see [page 267](#)) are used to select the digital channels for a bus.

Reporting the Setup

The following is a sample response from the :WAVEform? query. In this case, the query was issued following a *RST command.

```
:WAV:UNS 1;VIEW MAIN;BYT MSBF;FORM BYTE;POIN +1000;SOUR CHAN1;SOUR:SUBS  
NONE
```

:WAVeform:BYTeorder

C (see [page 1384](#))

Command Syntax :WAVeform:BYTeorder <value>
 <value> ::= {LSBFirst | MSBFirst}

The :WAVeform:BYTeorder command sets the output sequence of the WORD data. The parameter MSBFirst sets the most significant byte to be transmitted first. The parameter LSBFirst sets the least significant byte to be transmitted first. This command affects the transmitting sequence only when :WAVeform:FORMat WORD is selected. The default setting is LSBFirst.

Query Syntax :WAVeform:BYTeorder?

The :WAVeform:BYTeorder query returns the current output sequence.

Return Format <value><NL>
 <value> ::= {LSBF | MSBF}

- See Also**
- ["Introduction to :WAVeform Commands"](#) on page 1197
 - [":WAVeform:DATA"](#) on page 1205
 - [":WAVeform:FORMat"](#) on page 1207
 - [":WAVeform:PREamble"](#) on page 1212

- Example Code**
- ["Example Code"](#) on page 1218
 - ["Example Code"](#) on page 1213

:WAVEform:COUNT

C (see [page 1384](#))

Query Syntax :WAVEform:COUNT?

The :WAVEform:COUNT? query returns the count used to acquire the current waveform. This may differ from current values if the unit has been stopped and its configuration modified. For all acquisition types except average, this value is 1.

Return Format <count_argument><NL>

<count_argument> ::= an integer from 1 to 65536 in NR1 format

- See Also**
- ["Introduction to :WAVEform Commands"](#) on page 1197
 - [":ACQUIRE:COUNT"](#) on page 256
 - [":ACQUIRE:TYPE"](#) on page 265

:WAVEform:DATA

C (see [page 1384](#))

Query Syntax :WAVEform:DATA?

The :WAVEform:DATA query returns the binary block of sampled data points transmitted using the IEEE 488.2 arbitrary block data format. The binary data is formatted according to the settings of the :WAVEform:UNSIGNED, :WAVEform:BYTEORDER, :WAVEform:FORMAT, and :WAVEform:SOURCE commands. The number of points returned is controlled by the :WAVEform:POINTS command.

In BYTE or WORD waveform formats, these data values have special meaning:

- 0x00 or 0x0000 – Hole. Holes are locations where data has not yet been acquired.

Another situation where there can be zeros in the data, incorrectly, is when programming over telnet port 5024. Port 5024 provides a command prompt and is intended for ASCII transfers. Use telnet port 5025 instead.

- 0x01 or 0x0001 – Clipped low. These are locations where the waveform is clipped at the bottom of the oscilloscope display.
- 0xFF or 0xFFFF – Clipped high. These are locations where the waveform is clipped at the top of the oscilloscope display.

Return Format <binary block data><NL>

- See Also**
- For a more detailed description of the data returned for different acquisition types, see: "[Introduction to :WAVEform Commands](#)" on page 1197
 - "[:WAVEform:UNSIGNED](#)" on page 1223
 - "[:WAVEform:BYTEORDER](#)" on page 1203
 - "[:WAVEform:FORMAT](#)" on page 1207
 - "[:WAVEform:POINTS](#)" on page 1208
 - "[:WAVEform:PREAmble](#)" on page 1212
 - "[:WAVEform:SOURce](#)" on page 1217
 - "[:WAVEform:TYPE](#)" on page 1222

Example Code

```
' QUERY_WAVE_DATA - Outputs waveform data that is stored in a buffer.

' Query the oscilloscope for the waveform data.
myScope.WriteString ":WAV:DATA?"

' READ_WAVE_DATA - The wave data consists of two parts: the header,
' and the actual waveform data followed by a new line (NL) character.
' The query data has the following format:
'
'     <header><waveform_data><NL>
'
' Where:
'     <header> = #800001000 (This is an example header)
```

```

' The "#8" may be stripped off of the header and the remaining
' numbers are the size, in bytes, of the waveform data block. The
' size can vary depending on the number of points acquired for the
' waveform. You can then read that number of bytes from the
' oscilloscope and the terminating NL character.
'
Dim lngI As Long
Dim lngDataValue As Long

varQueryResult = myScope.ReadIEEEBlock(BinaryType_UI1)
' Unsigned integer bytes.
For lngI = 0 To UBound(varQueryResult) _
    Step (UBound(varQueryResult) / 20) _ ' 20 points.
    If intBytesPerData = 2 Then
        lngDataValue = varQueryResult(lngI) * 256 _
            + varQueryResult(lngI + 1) ' 16-bit value.
    Else
        lngDataValue = varQueryResult(lngI) ' 8-bit value.
    End If
    strOutput = strOutput + "Data point " + _
        CStr(lngI / intBytesPerData) + ", " + _
        FormatNumber((lngDataValue - lngYReference) _
            * sngYIncrement + sngYOrigin) + " V, " + _
        FormatNumber(((lngI / intBytesPerData - lngXReference) _
            * sngXIncrement + dblXOrigin) * 1000000) + " us" + vbCrLf
Next lngI
MsgBox "Waveform data:" + vbCrLf + strOutput

```

See complete example programs at: [Chapter 42](#), “Programming Examples,” starting on page 1393

:WAVEform:FORMat

C (see [page 1384](#))

Command Syntax :WAVEform:FORMat <value>

<value> ::= {WORD | BYTE | ASCii}

The :WAVEform:FORMat command sets the data transmission mode for waveform data points. This command controls how the data is formatted when sent from the oscilloscope.

- ASCII formatted data converts the internal integer data values to real Y-axis values. Values are transferred as ASCII digits in floating point notation, separated by commas.

ASCII formatted data is transferred ASCII text.

- WORD formatted data transfers 16-bit data as two bytes. The :WAVEform:BYTeorder command can be used to specify whether the upper or lower byte is transmitted first. The default (no command sent) is that the upper byte transmitted first.
- BYTE formatted data is transferred as 8-bit bytes.

When the :WAVEform:SOURce is the serial decode bus (SBUS1 or SBUS2), ASCII is the only waveform format allowed.

When the :WAVEform:SOURce is one of the digital channel buses (BUS1 or BUS2), ASCII and WORD are the only waveform formats allowed.

Query Syntax :WAVEform:FORMat?

The :WAVEform:FORMat query returns the current output format for the transfer of waveform data.

Return Format <value><NL>

<value> ::= {WORD | BYTE | ASC}

- See Also**
- ["Introduction to :WAVEform Commands"](#) on page 1197
 - [":WAVEform:BYTeorder"](#) on page 1203
 - [":WAVEform:SOURce"](#) on page 1217
 - [":WAVEform:DATA"](#) on page 1205
 - [":WAVEform:PREamble"](#) on page 1212

Example Code • ["Example Code"](#) on page 1218

:WAVEform:POINts

C (see [page 1384](#))

Command Syntax :WAVEform:POINts <# points>

```
<# points> ::= {100 | 250 | 500 | 1000 | <points mode>}
              if waveform points mode is NORMAl

<# points> ::= {100 | 250 | 500 | 1000 | 2000 | 5000 | 10000 | 20000
              | 50000 | 100000 | 200000 | 500000 | 1000000 | 2000000
              | 4000000 | 8000000 | <points mode>}
              if waveform points mode is MAXimum or RAW

<points mode> ::= {NORMAl | MAXimum | RAW}
```

NOTE

The <points_mode> option is deprecated. Use the :WAVEform:POINts:MODE command instead.

The :WAVEform:POINts command sets the number of waveform points to be transferred with the :WAVEform:DATA? query. This value represents the points contained in the waveform selected with the :WAVEform:SOURce command.

For the analog or digital sources, the records that can be transferred depend on the waveform points mode. The maximum number of points returned for math (function) waveforms is determined by the NORMAl waveform points mode. See the :WAVEform:POINts:MODE command (see [page 1210](#)) for more information.

Only data visible on the display will be returned.

When the :WAVEform:SOURce is the serial decode bus (SBUS1 or SBUS2), this command is ignored, and all available serial decode bus data is returned.

Query Syntax :WAVEform:POINts?

The :WAVEform:POINts query returns the number of waveform points to be transferred when using the :WAVEform:DATA? query. Setting the points mode will affect what data is transferred (see the :WAVEform:POINts:MODE command (see [page 1210](#)) for more information).

When the :WAVEform:SOURce is the serial decode bus (SBUS1 or SBUS2), this query returns the number of messages that were decoded.

Return Format <# points><NL>

```
<# points> ::= {100 | 250 | 500 | 1000 | <maximum # points>}
              if waveform points mode is NORMAl

<# points> ::= {100 | 250 | 500 | 1000 | 2000 | 5000 | 10000 | 20000
              | 50000 | 100000 | 200000 | 500000 | 1000000 | 2000000
              | 4000000 | 8000000 | <maximum # points>}
              if waveform points mode is MAXimum or RAW
```

NOTE

If a full screen of data is not displayed, the number of points returned will not be 1000 or an even divisor of it.

- See Also**
- [":WAVeform Commands"](#) on page 1197
 - [":ACQuire:POINts"](#) on page 258
 - [":WAVeform:DATA"](#) on page 1205
 - [":WAVeform:SOURce"](#) on page 1217
 - [":WAVeform:VIEW"](#) on page 1224
 - [":WAVeform:PREamble"](#) on page 1212
 - [":WAVeform:POINts:MODE"](#) on page 1210

Example Code

```
' WAVE_POINTS - Specifies the number of points to be transferred  
' using the ":WAVEFORM:DATA?" query.  
myScope.WriteString ":WAVEFORM:POINTS 1000"
```

See complete example programs at: [Chapter 42](#), "Programming Examples," starting on page 1393

:WAVEform:POINts:MODE

N (see [page 1384](#))

Command Syntax :WAVEform:POINts:MODE <points_mode>

<points_mode> ::= {NORMal | MAXimum | RAW}

The :WAVEform:POINts:MODE command sets the data record to be transferred with the :WAVEform:DATA? query.

For the analog or digital sources, there are two different records that can be transferred:

- The first is the raw acquisition record. The maximum number of points available in this record is returned by the :ACQUIRE:POINts? query. The raw acquisition record can only be retrieved from the analog or digital sources.
- The second is referred to as the *measurement record* and is a 62,500-point (maximum) representation of the raw acquisition record. The measurement record can be retrieved from any source.

If the <points_mode> is NORMal the measurement record is retrieved.

If the <points_mode> is RAW, the raw acquisition record is used. Under some conditions, this data record is unavailable.

If the <points_mode> is MAXimum, whichever record contains the maximum amount of points is used. Usually, this is the raw acquisition record. But, the measurement record may have more data. If data is being retrieved as the oscilloscope is stopped and as the data displayed is changing, the data being retrieved can switch between the measurement and raw acquisition records.

**Considerations for
MAXimum or RAW
data retrieval**

- The instrument must be stopped (see the :STOP command (see [page 250](#)) or the :DIGitize command (see [page 225](#)) in the root subsystem) in order to return more than the *measurement record*.
- :TIMEbase:MODE must be set to MAIN.
- :ACQUIRE:TYPE must be set to NORMal, AVERage, or HRESolution.
- MAXimum or RAW will allow up to 4,000,000 points to be returned. The number of points returned will vary as the instrument's configuration is changed. Use the :WAVEform:POINts? MAXimum query to determine the maximum number of points that can be retrieved at the current settings.

Query Syntax :WAVEform:POINts:MODE?

The :WAVEform:POINts:MODE? query returns the current points mode. Setting the points mode will affect what data is transferred. See the discussion above.

Return Format <points_mode><NL>

<points_mode> ::= {NORMal | MAXimum | RAW}

See Also • ["Introduction to :WAVEform Commands"](#) on page 1197

- **":WAVeform:DATA"** on page 1205
- **":ACQuire:POINts"** on page 258
- **":WAVeform:VIEW"** on page 1224
- **":WAVeform:PREamble"** on page 1212
- **":WAVeform:POINts"** on page 1208
- **":TIMebase:MODE"** on page 1087
- **":ACQuire:TYPE"** on page 265
- **":ACQuire:COUNT"** on page 256

:WAVEform:PREamble

C (see [page 1384](#))

Query Syntax :WAVEform:PREamble?

The :WAVEform:PREamble query requests the preamble information for the selected waveform source. The preamble data contains information concerning the vertical and horizontal scaling of the data of the corresponding channel.

Return Format <preamble_block><NL>

```
<preamble_block> ::= <format 16-bit NR1>,
                    <type 16-bit NR1>,
                    <points 32-bit NR1>,
                    <count 32-bit NR1>,
                    <xincrement 64-bit floating point NR3>,
                    <xorigin 64-bit floating point NR3>,
                    <xreference 32-bit NR1>,
                    <yincrement 32-bit floating point NR3>,
                    <yorigin 32-bit floating point NR3>,
                    <yreference 32-bit NR1>
```

<format> ::= 0 for BYTE format, 1 for WORD format, 4 for ASCII format;
an integer in NR1 format (format set by :WAVEform:FORMat).

<type> ::= 3 for HRESolution type, 2 for AVERAge type, 0 for NORMAl
type, 1 for PEAK detect type; an integer in NR1 format
(type set by :ACQuire:TYPE).

<count> ::= Average count or 1 if PEAK or NORMAl; an integer in NR1
format (count set by :ACQuire:COUNT).

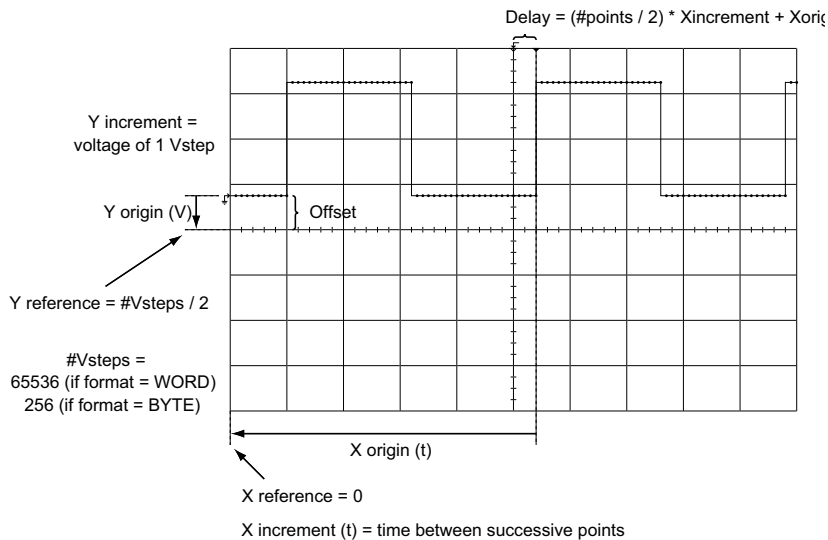

- See Also**
- ["Introduction to :WAVEform Commands"](#) on page 1197
 - [":ACQuire:COUNT"](#) on page 256

- ":ACQuire:POINts" on page 258
- ":ACQuire:TYPE" on page 265
- ":DIGitize" on page 225
- ":WAVEform:COUnT" on page 1204
- ":WAVEform:DATA" on page 1205
- ":WAVEform:FORMat" on page 1207
- ":WAVEform:POINts" on page 1208
- ":WAVEform:TYPE" on page 1222
- ":WAVEform:XINCrement" on page 1225
- ":WAVEform:XORigin" on page 1226
- ":WAVEform:XREFerence" on page 1227
- ":WAVEform:YINCrement" on page 1228
- ":WAVEform:YORigin" on page 1229
- ":WAVEform:YREFerence" on page 1230

Example Code

```

' GET_PREAMBLE - The preamble block contains all of the current
' WAVEFORM settings. It is returned in the form <preamble_block><NL>
' where <preamble_block> is:
'   FORMAT      : int16 - 0 = BYTE, 1 = WORD, 4 = ASCII.
'   TYPE        : int16 - 0 = NORM, 1 = PEAK, 2 = AVER, 3 = HRES
'   POINTS      : int32 - number of data points transferred.
'   COUNT       : int32 - 1 and is always 1.
'   XINCREMENT  : float64 - time difference between data points.
'   XORIGIN     : float64 - always the first data point in memory.
'   XREFERENCE  : int32 - specifies the data point associated with
'                   x-origin.
'   YINCREMENT  : float32 - voltage diff between data points.
'   YORIGIN     : float32 - value is the voltage at center screen.
'   YREFERENCE  : int32 - specifies the data point where y-origin
'                   occurs.

Dim Preamble()
Dim intFormat As Integer
Dim intType As Integer
Dim lngPoints As Long
Dim lngCount As Long
Dim dblXIncrement As Double
Dim dblXOrigin As Double
Dim lngXReference As Long
Dim sngYIncrement As Single
Dim sngYOrigin As Single
Dim lngYReference As Long
Dim strOutput As String

myScope.WriteString ":WAVEFORM:PREAMBLE?" ' Query for the preamble.
Preamble() = myScope.ReadList ' Read preamble information.
intFormat = Preamble(0)
intType = Preamble(1)
lngPoints = Preamble(2)

```

```
lngCount = Preamble(3)
dblXIncrement = Preamble(4)
dblXOrigin = Preamble(5)
lngXReference = Preamble(6)
sngYIncrement = Preamble(7)
sngYOrigin = Preamble(8)
lngYReference = Preamble(9)
```

See complete example programs at: [Chapter 42](#), “Programming Examples,” starting on page 1393

:WAVEform:SEGMented:COUNT

N (see [page 1384](#))

Query Syntax :WAVEform:SEGMented:COUNT?

NOTE

This command is available when the segmented memory option (Option SGM) is enabled.

The :WAVEform:SEGMented:COUNT query returns the number of memory segments in the acquired data. You can use the :WAVEform:SEGMented:COUNT? query while segments are being acquired (although :DIGitize blocks subsequent queries until the full segmented acquisition is complete).

The segmented memory acquisition mode is enabled with the :ACQUIRE:MODE command. The number of segments to acquire is set using the :ACQUIRE:SEGMented:COUNT command, and data is acquired using the :DIGitize, :SINGLE, or :RUN commands.

Return Format <count> ::= an integer from 2 to 1000 in NR1 format (count set by :ACQUIRE:SEGMented:COUNT) .

- See Also**
- [":ACQUIRE:MODE"](#) on page 257
 - [":ACQUIRE:SEGMented:COUNT"](#) on page 260
 - [":DIGitize"](#) on page 225
 - [":SINGLE"](#) on page 248
 - [":RUN"](#) on page 246
 - ["Introduction to :WAVEform Commands"](#) on page 1197

Example Code • ["Example Code"](#) on page 261

:WAVeform:SEGMented:TTAG**N** (see [page 1384](#))**Query Syntax** :WAVeform:SEGMented:TTAG?**NOTE**

This command is available when the segmented memory option (Option SGM) is enabled.

The :WAVeform:SEGMented:TTAG? query returns the time tag of the currently selected segmented memory index. The index is selected using the :ACQuire:SEGMented:INDex command.

Return Format <time_tag> ::= in NR3 format

- See Also**
- [":ACQuire:SEGMented:INDex"](#) on page 261
 - ["Introduction to :WAVeform Commands"](#) on page 1197

Example Code • ["Example Code"](#) on page 261

:WAVEform:SOURce

C (see [page 1384](#))

Command Syntax :WAVEform:SOURce <source>

```
<source> ::= {CHANnel<n> | FUNCTION<m> | MATH<m> | FFT | WMEMory<r>
             | SBUS{1 | 2}} for DSO models
```

```
<source> ::= {CHANnel<n> | POD{1 | 2} | BUS{1 | 2} | FUNCTION<m>
             | MATH<m> | FFT | WMEMory<r> | SBUS{1 | 2}}
             for MSO models
```

```
<n> ::= 1 to (# analog channels) in NR1 format
```

```
<m> ::= 1 to (# math functions) in NR1 format
```

```
<r> ::= 1 to (# ref waveforms) in NR1 format
```

The :WAVEform:SOURce command selects the analog channel, function, digital pod, digital bus, reference waveform, or serial decode bus to be used as the source for the :WAVEform commands.

Function capabilities include add, subtract, multiply, integrate, differentiate, and FFT (Fast Fourier Transform) operations.

When the :WAVEform:SOURce is the serial decode bus (SBUS1 or SBUS2), ASCII is the only waveform format allowed, and the :WAVEform:DATA? query returns a string with timestamps and associated bus decode information.

With MSO oscilloscope models, you can choose a POD or BUS as the waveform source. There are some differences between POD and BUS when formatting and getting data from the oscilloscope:

- When POD1 or POD2 is selected as the waveform source, you can choose the BYTE, WORD, or ASCII formats (see [":WAVEform:FORMat"](#) on page 1207).

When the WORD format is chosen, every other data byte will be 0. The setting of :WAVEform:BYTeorder controls which byte is 0.

When the ASCII format is chosen, the :WAVEform:DATA? query returns a string with unsigned decimal values separated by commas.

- When BUS1 or BUS2 is selected as the waveform source, you can choose the WORD or ASCII formats (but not BYTE because bus values are always returned as 16-bit values).

When the ASCII format is chosen, the :WAVEform:DATA? query returns a string with hexadecimal bus values, for example: 0x1938,0xff38,...

Query Syntax :WAVEform:SOURce?

The :WAVEform:SOURce? query returns the currently selected source for the WAVEform commands.

NOTE

MATH<m> is an alias for FUNCtion<m>. The :WAVEform:SOURce? query returns FUNC<m> if the source is FUNCtion<m> or MATH<m>.

Return Format

<source><NL>

<source> ::= {CHAN<n> | FUNC<m> | WMEM<r> | SBUS{1 | 2}} for DSO models

<source> ::= {CHAN<n> | POD{1 | 2} | BUS{1 | 2} | FUNC<m>
| WMEM<r> | SBUS{1 | 2}} for MSO models

<n> ::= 1 to (# analog channels) in NR1 format

<m> ::= 1 to (# math functions) in NR1 format

<r> ::= 1 to (# ref waveforms) in NR1 format

See Also

- ["Introduction to :WAVEform Commands"](#) on page 1197
- [":DIGitize"](#) on page 225
- [":WAVEform:FORMat"](#) on page 1207
- [":WAVEform:BYTeorder"](#) on page 1203
- [":WAVEform:DATA"](#) on page 1205
- [":WAVEform:PREamble"](#) on page 1212

Example Code

```
' WAVEFORM_DATA - To obtain waveform data, you must specify the
' WAVEFORM parameters for the waveform data prior to sending the
' ":WAVEFORM:DATA?" query. Once these parameters have been sent,
' the waveform data and the preamble can be read.
'
' WAVE_SOURCE - Selects the channel to be used as the source for
' the waveform commands.
myScope.WriteString ":WAVEFORM:SOURCE CHAN1"

' WAVE_POINTS - Specifies the number of points to be transferred
' using the ":WAVEFORM:DATA?" query.
myScope.WriteString ":WAVEFORM:POINTS 1000"

' WAVE_FORMAT - Sets the data transmission mode for the waveform
' data output. This command controls whether data is formatted in
' a word or byte format when sent from the oscilloscope.
Dim lngVSteps As Long
Dim intBytesPerData As Integer

' Data in range 0 to 65535.
myScope.WriteString ":WAVEFORM:FORMAT WORD"
lngVSteps = 65536
intBytesPerData = 2

' Data in range 0 to 255.
myScope.WriteString ":WAVEFORM:FORMAT BYTE"
lngVSteps = 256
intBytesPerData = 1

' GET_PREAMBLE - The preamble block contains all of the current
```

```

' WAVEFORM settings. It is returned in the form <preamble_block><NL>
' where <preamble_block> is:
'   FORMAT       : int16 - 0 = BYTE, 1 = WORD, 4 = ASCII.
'   TYPE         : int16 - 0 = NORMAL, 1 = PEAK DETECT, 2 = AVERAGE
'   POINTS       : int32 - number of data points transferred.
'   COUNT        : int32 - 1 and is always 1.
'   XINCREMENT   : float64 - time difference between data points.
'   XORIGIN      : float64 - always the first data point in memory.
'   XREFERENCE   : int32 - specifies the data point associated with
'                   x-origin.
'   YINCREMENT   : float32 - voltage diff between data points.
'   YORIGIN      : float32 - value is the voltage at center screen.
'   YREFERENCE   : int32 - specifies the data point where y-origin
'                   occurs.
Dim Preamble()
Dim intFormat As Integer
Dim intType As Integer
Dim lngPoints As Long
Dim lngCount As Long
Dim dblXIncrement As Double
Dim dblXOrigin As Double
Dim lngXReference As Long
Dim sngYIncrement As Single
Dim sngYOrigin As Single
Dim lngYReference As Long
Dim strOutput As String

myScope.WriteString ":WAVEFORM:PREAMBLE?" ' Query for the preamble.
Preamble() = myScope.ReadList ' Read preamble information.
intFormat = Preamble(0)
intType = Preamble(1)
lngPoints = Preamble(2)
lngCount = Preamble(3)
dblXIncrement = Preamble(4)
dblXOrigin = Preamble(5)
lngXReference = Preamble(6)
sngYIncrement = Preamble(7)
sngYOrigin = Preamble(8)
lngYReference = Preamble(9)
strOutput = ""
'strOutput = strOutput + "Format = " + CStr(intFormat) + vbCrLf
'strOutput = strOutput + "Type = " + CStr(intType) + vbCrLf
'strOutput = strOutput + "Points = " + CStr(lngPoints) + vbCrLf
'strOutput = strOutput + "Count = " + CStr(lngCount) + vbCrLf
'strOutput = strOutput + "X increment = " + _
'   FormatNumber(dblXIncrement * 1000000) + " us" + vbCrLf
'strOutput = strOutput + "X origin = " + _
'   FormatNumber(dblXOrigin * 1000000) + " us" + vbCrLf
'strOutput = strOutput + "X reference = " + _
'   CStr(lngXReference) + vbCrLf
'strOutput = strOutput + "Y increment = " + _
'   FormatNumber(sngYIncrement * 1000) + " mV" + vbCrLf
'strOutput = strOutput + "Y origin = " + _
'   FormatNumber(sngYOrigin) + " V" + vbCrLf
'strOutput = strOutput + "Y reference = " + _
'   CStr(lngYReference) + vbCrLf
strOutput = strOutput + "Volts/Div = " + _

```

```

        FormatNumber(lngVSteps * sngYIncrement / 8) + _
        " V" + vbCrLf
strOutput = strOutput + "Offset = " + _
        FormatNumber((lngVSteps / 2 - lngYReference) * _
        sngYIncrement + sngYOrigin) + " V" + vbCrLf
strOutput = strOutput + "Sec/Div = " + _
        FormatNumber(lngPoints * dblXIncrement / 10 * _
        1000000) + " us" + vbCrLf
strOutput = strOutput + "Delay = " + _
        FormatNumber(((lngPoints / 2 - lngXReference) * _
        dblXIncrement + dblXOrigin) * 1000000) + " us" + vbCrLf

' QUERY_WAVE_DATA - Outputs waveform data that is stored in a buffer.

' Query the oscilloscope for the waveform data.
myScope.WriteString ":WAV:DATA?"

' READ_WAVE_DATA - The wave data consists of two parts: the header,
' and the actual waveform data followed by a new line (NL) character.
' The query data has the following format:
'
'   <header><waveform_data><NL>
'
' Where:
'   <header> = #800001000 (This is an example header)
' The "#8" may be stripped off of the header and the remaining
' numbers are the size, in bytes, of the waveform data block. The
' size can vary depending on the number of points acquired for the
' waveform. You can then read that number of bytes from the
' oscilloscope and the terminating NL character.
'
Dim lngI As Long
Dim lngDataValue As Long

' Unsigned integer bytes.
varQueryResult = myScope.ReadIEEEBlock(BinaryType_UI1)

For lngI = 0 To UBound(varQueryResult) _
    Step (UBound(varQueryResult) / 20) ' 20 points.
    If intBytesPerData = 2 Then
        lngDataValue = varQueryResult(lngI) * 256 _
            + varQueryResult(lngI + 1) ' 16-bit value.
    Else
        lngDataValue = varQueryResult(lngI) ' 8-bit value.
    End If
    strOutput = strOutput + "Data point " + _
        CStr(lngI / intBytesPerData) + ", " + _
        FormatNumber((lngDataValue - lngYReference) _
            * sngYIncrement + sngYOrigin) + " V, " + _
        FormatNumber(((lngI / intBytesPerData - lngXReference) _
            * sngXIncrement + dblXOrigin) * 1000000) + " us" + vbCrLf
Next lngI
MsgBox "Waveform data:" + vbCrLf + strOutput

```

See complete example programs at: [Chapter 42](#), "Programming Examples," starting on page 1393

:WAVeform:SOURce:SUBSource

C (see [page 1384](#))

Command Syntax :WAVeform:SOURce:SUBSource <subsource>

```
<subsource> ::= {SUB0 | RX | MOSI | FAST}
                | {SUB1 | TX | MISO | SLOW}
```

If the :WAVeform:SOURce is SBUS<n> (serial decode), more than one data set may be available, and this command lets you choose from the available data sets.

When using UART serial decode, this option lets you get "TX" data. (TX is an alias for SUB1.) The default, SUB0, specifies "RX" data. (RX is an alias for SUB0.)

When using SPI serial decode, this option lets you get "MISO" data. (MISO is an alias for SUB1.) The default, SUB0, specifies "MOSI" data. (MOSI is an alias for SUB0.)

When using SENT serial decode, this option lets you get "SLOW" data. (SLOW is an alias for SUB1.) The default, SUB0, specifies "FAST" data. (FAST is an alias for SUB0.)

If the :WAVeform:SOURce is not SBUS, or the :SBUS<n>:MODE is not UART, SPI, or SENT, the only valid subsource is SUB0.

Query Syntax :WAVeform:SOURce:SUBSource?

The :WAVeform:SOURce:SUBSource? query returns the current waveform subsource setting.

Return Format <subsource><NL>

```
<subsource> ::= {SUB0 | SUB1}
```

- See Also**
- ["Introduction to :WAVeform Commands"](#) on page 1197
 - [":WAVeform:SOURce"](#) on page 1217

:WAVEform:TYPE

C (see [page 1384](#))

Query Syntax :WAVEform:TYPE?

The :WAVEform:TYPE? query returns the acquisition mode associated with the currently selected waveform. The acquisition mode is set by the :ACQUIRE:TYPE command.

Return Format <mode><NL>

<mode> ::= {NORM | PEAK | AVER | HRES}

NOTE

If the :WAVEform:SOURce is POD1, POD2, or SBUS1, SBUS2, the type is always NORM.

-
- See Also**
- ["Introduction to :WAVEform Commands"](#) on page 1197
 - [":ACQUIRE:TYPE"](#) on page 265
 - [":WAVEform:DATA"](#) on page 1205
 - [":WAVEform:PREamble"](#) on page 1212
 - [":WAVEform:SOURce"](#) on page 1217

:WAVEform:UNSigned

C (see [page 1384](#))

Command Syntax :WAVEform:UNSigned <unsigned>

<unsigned> ::= {{0 | OFF} | {1 | ON}}

The :WAVEform:UNSigned command turns unsigned mode on or off for the currently selected waveform. Use the WAVEform:UNSigned command to control whether data values are sent as unsigned or signed integers. This command can be used to match the instrument's internal data type to the data type used by the programming language. This command has no effect if the data format is ASCII.

If :WAVEform:SOURce is set to POD1, POD2, BUS1, or BUS2, WAVEform:UNSigned must be set to ON.

Query Syntax :WAVEform:UNSigned?

The :WAVEform:UNSigned? query returns the status of unsigned mode for the currently selected waveform.

Return Format <unsigned><NL>

<unsigned> ::= {0 | 1}

- See Also**
- ["Introduction to :WAVEform Commands"](#) on page 1197
 - [":WAVEform:SOURce"](#) on page 1217

:WAVEform:VIEW

C (see [page 1384](#))

Command Syntax :WAVEform:VIEW <view>

<view> ::= {MAIN}

The :WAVEform:VIEW command sets the view setting associated with the currently selected waveform. Currently, the only legal value for the view setting is MAIN.

Query Syntax :WAVEform:VIEW?

The :WAVEform:VIEW? query returns the view setting associated with the currently selected waveform.

Return Format <view><NL>

<view> ::= {MAIN}

- See Also**
- ["Introduction to :WAVEform Commands"](#) on page 1197
 - [":WAVEform:POINts"](#) on page 1208

:WAVEform:XINCrement

C (see [page 1384](#))

Query Syntax :WAVEform:XINCrement?

The :WAVEform:XINCrement? query returns the x-increment value for the currently specified source. This value is the time difference between consecutive data points in seconds.

Return Format <value><NL>

<value> ::= x-increment in the current preamble in 64-bit floating point NR3 format

- See Also**
- ["Introduction to :WAVEform Commands"](#) on page 1197
 - [":WAVEform:PREamble"](#) on page 1212

Example Code • ["Example Code"](#) on page 1213

:WAVEform:XORigin

C (see [page 1384](#))

Query Syntax :WAVEform:XORigin?

The :WAVEform:XORigin? query returns the x-origin value for the currently specified source. XORigin is the X-axis value of the data point specified by the :WAVEform:XREFerence value. In this product, that is always the X-axis value of the first data point (XREFerence = 0).

Return Format <value><NL>

<value> ::= x-origin value in the current preamble in 64-bit floating point NR3 format

- See Also**
- ["Introduction to :WAVEform Commands"](#) on page 1197
 - [":WAVEform:PREamble"](#) on page 1212
 - [":WAVEform:XREFerence"](#) on page 1227

Example Code • ["Example Code"](#) on page 1213

:WAVEform:XREFerence

C (see [page 1384](#))

Query Syntax :WAVEform:XREFerence?

The :WAVEform:XREFerence? query returns the x-reference value for the currently specified source. This value specifies the index of the data point associated with the x-origin data value. In this product, the x-reference point is the first point displayed and XREFerence is always 0.

Return Format <value><NL>

<value> ::= x-reference value = 0 in 32-bit NR1 format

- See Also**
- ["Introduction to :WAVEform Commands"](#) on page 1197
 - [":WAVEform:PREamble"](#) on page 1212
 - [":WAVEform:XORigin"](#) on page 1226

Example Code • ["Example Code"](#) on page 1213

:WAVeform:YINCrement

C (see [page 1384](#))

Query Syntax :WAVeform:YINCrement?

The :WAVeform:YINCrement? query returns the y-increment value in volts for the currently specified source. This value is the voltage difference between consecutive data values. The y-increment for digital waveforms is always "1".

Return Format <value><NL>

<value> ::= y-increment value in the current preamble in 32-bit floating point NR3 format

- See Also**
- ["Introduction to :WAVeform Commands"](#) on page 1197
 - [":WAVeform:PREamble"](#) on page 1212

Example Code

- ["Example Code"](#) on page 1213

:WAVeform:YORigin

C (see [page 1384](#))

Query Syntax :WAVeform:YORigin?

The :WAVeform:YORigin? query returns the y-origin value for the currently specified source. This value is the Y-axis value of the data value specified by the :WAVeform:YREFerence value. For this product, this is the Y-axis value of the center of the screen.

Return Format <value><NL>

<value> ::= y-origin in the current preamble in 32-bit floating point NR3 format

- See Also**
- ["Introduction to :WAVeform Commands"](#) on page 1197
 - [":WAVeform:PREamble"](#) on page 1212
 - [":WAVeform:YREFerence"](#) on page 1230

Example Code • ["Example Code"](#) on page 1213

:WAVeform:YREFerence

C (see [page 1384](#))

Query Syntax :WAVeform:YREFerence?

The :WAVeform:YREFerence? query returns the y-reference value for the currently specified source. This value specifies the data point value where the y-origin occurs. In this product, this is the data point value of the center of the screen. It is undefined if the format is ASCII.

Return Format <value><NL>

<value> ::= y-reference value in the current preamble in 32-bit
NR1 format

- See Also**
- ["Introduction to :WAVeform Commands"](#) on page 1197
 - [":WAVeform:PREamble"](#) on page 1212
 - [":WAVeform:YORigin"](#) on page 1229

Example Code • ["Example Code"](#) on page 1213

35 :WGEN<w> Commands

When the built-in waveform generator is licensed (Option WGN), you can use it to output sine, square, ramp, pulse, DC, noise, sine cardinal, exponential rise, exponential fall, cardiac, and gaussian pulse waveforms. The :WGEN<w> commands are used to select the waveform function and parameters. See "[Introduction to :WGEN<w> Commands](#)" on page 1234.

Table 157 :WGEN<w> Commands Summary

Command	Query	Options and Query Returns
:WGEN<w>:ARbitrary:BYTeorder <order> (see page 1235)	:WGEN<w>:ARbitrary:BYTeorder? (see page 1235)	<order> ::= {MSBFirst LSBFirst} <w> ::= 1 or 2 in NR1 format
:WGEN<w>:ARbitrary:DATA {<binary> <value>, <value> ...} (see page 1236)	n/a	<binary> ::= floating point values between -1.0 to +1.0 in IEEE 488.2 binary block format <value> ::= floating point values between -1.0 to +1.0 in comma-separated format <w> ::= 1 or 2 in NR1 format
n/a	:WGEN<w>:ARbitrary:DATA:ATTRibute:POINTs? (see page 1237)	<points> ::= number of points in NR1 format <w> ::= 1 or 2 in NR1 format
:WGEN<w>:ARbitrary:DATA:CLEar (see page 1238)	n/a	<w> ::= 1 or 2 in NR1 format
:WGEN<w>:ARbitrary:DATA:DAC {<binary> <value>, <value> ...} (see page 1239)	n/a	<binary> ::= decimal 16-bit integer values between -512 to +511 in IEEE 488.2 binary block format <value> ::= decimal integer values between -512 to +511 in comma-separated NR1 format <w> ::= 1 or 2 in NR1 format

Table 157: WGEN<w> Commands Summary (continued)

Command	Query	Options and Query Returns
:WGEN<w>:ARbitrary:IN Terpolate {{0 OFF} {1 ON}} (see page 1240)	:WGEN<w>:ARbitrary:IN Terpolate? (see page 1240)	{0 1} <w> ::= 1 or 2 in NR1 format
:WGEN<w>:ARbitrary:ST ORe <source> (see page 1241)	n/a	<source> ::= {CHANnel<n> WMEMemory<r> FUNctIon<m> FFT MATH<m>} <n> ::= 1 to (# analog channels) in NR1 format <r> ::= 1 to (# ref waveforms) in NR1 format <m> ::= 1 to (# math functions) in NR1 format <w> ::= 1 or 2 in NR1 format
:WGEN<w>:FREquency <frequency> (see page 1242)	:WGEN<w>:FREquency? (see page 1242)	<frequency> ::= frequency in Hz in NR3 format <w> ::= 1 or 2 in NR1 format
:WGEN<w>:FUNctIon <signal> (see page 1243)	:WGEN<w>:FUNctIon? (see page 1246)	<signal> ::= {SINusoid SQUare RAMP PULSe NOISe DC SINC EXPRise EXPFall CARDiac GAUSSian ARBItrary} <w> ::= 1 or 2 in NR1 format
:WGEN<w>:FUNctIon:PUL Se:WIDTh <width> (see page 1247)	:WGEN<w>:FUNctIon:PUL Se:WIDTh? (see page 1247)	<width> ::= pulse width in seconds in NR3 format <w> ::= 1 or 2 in NR1 format
:WGEN<w>:FUNctIon:RAM P:SYMMetry <percent> (see page 1248)	:WGEN<w>:FUNctIon:RAM P:SYMMetry? (see page 1248)	<percent> ::= symmetry percentage from 0% to 100% in NR1 format <w> ::= 1 or 2 in NR1 format
:WGEN<w>:FUNctIon:SQU are:DCYClE <percent> (see page 1249)	:WGEN<w>:FUNctIon:SQU are:DCYClE? (see page 1249)	<percent> ::= duty cycle percentage from 20% to 80% in NR1 format <w> ::= 1 or 2 in NR1 format
:WGEN<w>:MODulation:A M:DEPTh <percent> (see page 1250)	:WGEN<w>:MODulation:A M:DEPTh? (see page 1250)	<percent> ::= AM depth percentage from 0% to 100% in NR1 format <w> ::= 1 in NR1 format
:WGEN<w>:MODulation:A M:FREquency <frequency> (see page 1251)	:WGEN<w>:MODulation:A M:FREquency? (see page 1251)	<frequency> ::= modulating waveform frequency in Hz in NR3 format <w> ::= 1 in NR1 format

Table 157 :WGEN<w> Commands Summary (continued)

Command	Query	Options and Query Returns
:WGEN<w>:MODulation:FM:DEVIation <frequency> (see page 1252)	:WGEN<w>:MODulation:FM:DEVIation? (see page 1252)	<frequency> ::= frequency deviation in Hz in NR3 format <w> ::= 1 in NR1 format
:WGEN<w>:MODulation:FM:FREQuency <frequency> (see page 1253)	:WGEN<w>:MODulation:FM:FREQuency? (see page 1253)	<frequency> ::= modulating waveform frequency in Hz in NR3 format <w> ::= 1 in NR1 format
:WGEN<w>:MODulation:FSKey:FREQuency <percent> (see page 1254)	:WGEN<w>:MODulation:FSKey:FREQuency? (see page 1254)	<frequency> ::= hop frequency in Hz in NR3 format <w> ::= 1 in NR1 format
:WGEN<w>:MODulation:FSKey:RATE <rate> (see page 1255)	:WGEN<w>:MODulation:FSKey:RATE? (see page 1255)	<rate> ::= FSK modulation rate in Hz in NR3 format <w> ::= 1 in NR1 format
:WGEN<w>:MODulation:FUNCTion <shape> (see page 1256)	:WGEN<w>:MODulation:FUNCTion? (see page 1256)	<shape> ::= {SINusoid SQUARE RAMP} <w> ::= 1 in NR1 format
:WGEN<w>:MODulation:FUNCTion:RAMP:SYMMetry <percent> (see page 1257)	:WGEN<w>:MODulation:FUNCTion:RAMP:SYMMetry? (see page 1257)	<percent> ::= symmetry percentage from 0% to 100% in NR1 format <w> ::= 1 in NR1 format
:WGEN<w>:MODulation:NOISe <percent> (see page 1258)	:WGEN<w>:MODulation:NOISe? (see page 1258)	<percent> ::= 0 to 100 <w> ::= 1 or 2 in NR1 format
:WGEN<w>:MODulation:STATe {{0 OFF} {1 ON}} (see page 1259)	:WGEN<w>:MODulation:STATe? (see page 1259)	{0 1} <w> ::= 1 in NR1 format
:WGEN<w>:MODulation:TYPe <type> (see page 1260)	:WGEN<w>:MODulation:TYPe? (see page 1260)	<type> ::= {AM FM FSK} <w> ::= 1 in NR1 format
:WGEN<w>:OUTPut {{0 OFF} {1 ON}} (see page 1262)	:WGEN<w>:OUTPut? (see page 1262)	{0 1} <w> ::= 1 or 2 in NR1 format
:WGEN<w>:OUTPut:LOAD <impedance> (see page 1263)	:WGEN<w>:OUTPut:LOAD? (see page 1263)	<impedance> ::= {ONEMeg FIFTy} <w> ::= 1 or 2 in NR1 format
:WGEN<w>:OUTPut:MODE <mode> (see page 1264)	:WGEN<w>:OUTPut:MODE? (see page 1264)	<mode> ::= {NORMal SINGle}

Table 157 :WGEN<w> Commands Summary (continued)

Command	Query	Options and Query Returns
:WGEN<w>:OUTPut:POLarity <polarity> (see page 1265)	:WGEN<w>:OUTPut:POLarity? (see page 1265)	<polarity> ::= {NORMAL INVERTed} <w> ::= 1 or 2 in NR1 format
:WGEN<w>:OUTPut:SINGle (see page 1266)	n/a	n/a
:WGEN<w>:PERiod <period> (see page 1267)	:WGEN<w>:PERiod? (see page 1267)	<period> ::= period in seconds in NR3 format <w> ::= 1 or 2 in NR1 format
:WGEN<w>:RST (see page 1268)	n/a	<w> ::= 1 or 2 in NR1 format
:WGEN<w>:VOLTage <amplitude> (see page 1269)	:WGEN<w>:VOLTage? (see page 1269)	<amplitude> ::= amplitude in volts in NR3 format <w> ::= 1 or 2 in NR1 format
:WGEN<w>:VOLTage:HIGH <high> (see page 1270)	:WGEN<w>:VOLTage:HIGH? (see page 1270)	<high> ::= high-level voltage in volts, in NR3 format <w> ::= 1 or 2 in NR1 format
:WGEN<w>:VOLTage:LOW <low> (see page 1271)	:WGEN<w>:VOLTage:LOW? (see page 1271)	<low> ::= low-level voltage in volts, in NR3 format <w> ::= 1 or 2 in NR1 format
:WGEN<w>:VOLTage:OFFSet <offset> (see page 1272)	:WGEN<w>:VOLTage:OFFSet? (see page 1272)	<offset> ::= offset in volts in NR3 format <w> ::= 1 or 2 in NR1 format

Introduction to :WGEN<w> Commands

The :WGEN<w> subsystem provides commands to select the waveform generator function and parameters.

In the :WGEN<w> commands, the <w> can be 1 or 2, and :WGEN is equivalent to :WGEN1

Reporting the Setup

Use :WGEN<w>? to query setup information for the WGEN<w> subsystem.

Return Format

The following is a sample response from the :WGEN? query. In this case, the query was issued following the *RST command.

```
:WGEN1:FUNC SIN;OUTP 0;FREQ +1.0000E+03;VOLT +500.0E-03;VOLT:OFFS
+0.0E+00;:WGEN1:OUTP:LOAD ONEM
```

:WGEN<w>:ARbitrary:BYTeorder

N (see [page 1384](#))

Command Syntax :WGEN<w>:ARbitrary:BYTeorder <order>

<w> ::= 1 or 2 in NR1 format

<order> ::= {MSBFirst | LSBFirst}

The :WGEN<w>:ARbitrary:BYTeorder command selects the byte order for binary transfers.

Query Syntax :WGEN<w>:ARbitrary:BYTeorder?

The :WGEN<w>:ARbitrary:BYTeorder query returns the current byte order selection.

Return Format <order><NL>

<order> ::= {MSBFirst | LSBFirst}

- See Also**
- [":WGEN<w>:ARbitrary:DATA"](#) on page 1236
 - [":WGEN<w>:ARbitrary:DATA:DAC"](#) on page 1239

:WGEN<w>:ARbitrary:DATA

N (see [page 1384](#))

Command Syntax :WGEN<w>:ARbitrary:DATA {<binary> | <value>, <value> ...}

<w> ::= 1 or 2 in NR1 format

<binary> ::= floating point values between -1.0 to +1.0
in IEEE 488.2 binary block format

<value> ::= floating point values between -1.0 to +1.0
in comma-separated format

The :WGEN<w>:ARbitrary:DATA command downloads an arbitrary waveform in floating-point values format.

- See Also**
- [":WGEN<w>:ARbitrary:DATA:DAC"](#) on page 1239
 - [":SAVE:ARbitrary\[:START\]"](#) on page 729
 - [":RECall:ARbitrary\[:START\]"](#) on page 717

:WGEN<w>:ARbitrary:DATA:ATTRibute:POINts

N (see [page 1384](#))

Query Syntax :WGEN<w>:ARbitrary:DATA:ATTRibute:POINts?
 <w> ::= 1 or 2 in NR1 format

The :WGEN<w>:ARbitrary:DATA:ATTRibute:POINts query returns the number of points used by the current arbitrary waveform.

Return Format <points> ::= number of points in NR1 format

- See Also**
- [":WGEN<w>:ARbitrary:DATA"](#) on page 1236
 - [":WGEN<w>:ARbitrary:DATA:DAC"](#) on page 1239
 - [":SAVE:ARbitrary\[:START\]"](#) on page 729
 - [":RECall:ARbitrary\[:START\]"](#) on page 717

:WGEN<w>:ARbitrary:DATA:CLEAr

N (see [page 1384](#))

Command Syntax :WGEN<w>:ARbitrary:DATA:CLEAr
<w> ::= 1 or 2 in NR1 format

The :WGEN<w>:ARbitrary:DATA:CLEAr command clears the arbitrary waveform memory and loads it with the default waveform.

- See Also**
- [":WGEN<w>:ARbitrary:DATA"](#) on page 1236
 - [":WGEN<w>:ARbitrary:DATA:DAC"](#) on page 1239
 - [":SAVE:ARbitrary\[:START\]"](#) on page 729
 - [":RECall:ARbitrary\[:START\]"](#) on page 717

:WGEN<w>:ARbitrary:DATA:DAC

N (see [page 1384](#))

Command Syntax :WGEN<w>:ARbitrary:DATA:DAC {<binary> | <value>, <value> ...}

<w> ::= 1 or 2 in NR1 format

<binary> ::= decimal 16-bit integer values between -512 to +511
in IEEE 488.2 binary block format

<value> ::= decimal integer values between -512 to +511
in comma-separated NR1 format

The :WGEN<w>:ARbitrary:DATA:DAC command downloads an arbitrary waveform using 16-bit integer (DAC) values.

- See Also**
- [":WGEN<w>:ARbitrary:DATA"](#) on page 1236
 - [":SAVE:ARbitrary\[:START\]"](#) on page 729
 - [":RECall:ARbitrary\[:START\]"](#) on page 717

:WGEN<w>:ARbitrary:INTerpolate

N (see [page 1384](#))

Command Syntax :WGEN<w>:ARbitrary:INTerpolate {{0 | OFF} | {1 | ON}}
 <w> ::= 1 or 2 in NR1 format

The :WGEN<w>:ARbitrary:INTerpolate command enables or disables the Interpolation control.

Interpolation specifies how lines are drawn between arbitrary waveform points:

- When ON, lines are drawn between points in the arbitrary waveform. Voltage levels change linearly between one point and the next.
- When OFF, all line segments in the arbitrary waveform are horizontal. The voltage level of one point remains until the next point.

Query Syntax :WGEN<w>:ARbitrary:INTerpolate?

The :WGEN<w>:ARbitrary:INTerpolate query returns the current interpolation setting.

Return Format {0 | 1}

- See Also**
- [":WGEN<w>:ARbitrary:DATA"](#) on page 1236
 - [":WGEN<w>:ARbitrary:DATA:DAC"](#) on page 1239
 - [":SAVE:ARbitrary\[:START\]"](#) on page 729
 - [":RECall:ARbitrary\[:START\]"](#) on page 717

:WGEN<w>:ARbitrary:STORe

N (see [page 1384](#))

Command Syntax :WGEN<w>:ARbitrary:STORe <source>

<w> ::= 1 or 2 in NR1 format

<source> ::= {CHANnel<n> | WMEMory<r> | FUNction<m> | MATH<m> | FFT}

<n> ::= 1 to (# analog channels) in NR1 format

<r> ::= 1 to (# ref waveforms) in NR1 format

<m> ::= 1 to (# math functions) in NR1 format

The :WGEN<w>:ARbitrary:STORe command stores the source's waveform into the arbitrary waveform memory.

- See Also**
- [":WGEN<w>:ARbitrary:DATA"](#) on page 1236
 - [":WGEN<w>:ARbitrary:DATA:DAC"](#) on page 1239
 - [":SAVE:ARbitrary\[:START\]"](#) on page 729
 - [":RECall:ARbitrary\[:START\]"](#) on page 717

:WGEN<w>:FREQuency

N (see [page 1384](#))

Command Syntax :WGEN<w>:FREQuency <frequency>

<w> ::= 1 or 2 in NR1 format

<frequency> ::= frequency in Hz in NR3 format

For all waveforms except Noise and DC, the :WGEN<w>:FREQuency command specifies the frequency of the waveform.

You can also specify the frequency indirectly using the :WGEN<w>:PERiod command.

Query Syntax :WGEN<w>:FREQuency?

The :WGEN<w>:FREQuency? query returns the currently set waveform generator frequency.

Return Format <frequency><NL>

<frequency> ::= frequency in Hz in NR3 format

- See Also**
- ["Introduction to :WGEN<w> Commands"](#) on page 1234
 - [":WGEN<w>:FUNction"](#) on page 1243
 - [":WGEN<w>:PERiod"](#) on page 1267

:WGEN<w>:FUNction

N (see [page 1384](#))

Command Syntax :WGEN<w>:FUNction <signal>

<w> ::= 1 or 2 in NR1 format

<signal> ::= {SINusoid | SQUare | RAMP | PULSe | DC | NOISe | SINC
| EXPRise | EXPFall | CARDiac | GAUSSian | ARBitary}

The :WGEN<w>:FUNction command selects the type of waveform:

Waveform Type	Characteristics	Frequency Range	Max. Amplitude ² (High-Z) ¹	Offset ² (High-Z) ¹
SINusoid	Use these commands to set the sine signal parameters: <ul style="list-style-type: none"> ▪ ":WGEN<w>:FREQuency" on page 1242 ▪ ":WGEN<w>:PERiod" on page 1267 ▪ ":WGEN<w>:VOLTage" on page 1269 ▪ ":WGEN<w>:VOLTage:OFFSet" on page 1272 ▪ ":WGEN<w>:VOLTage:HIGH" on page 1270 ▪ ":WGEN<w>:VOLTage:LOW" on page 1271 	100 mHz to 20 MHz	20 mVpp to 10 Vpp	±4.00 V
SQUare	Use these commands to set the square wave signal parameters: <ul style="list-style-type: none"> ▪ ":WGEN<w>:FREQuency" on page 1242 ▪ ":WGEN<w>:PERiod" on page 1267 ▪ ":WGEN<w>:VOLTage" on page 1269 ▪ ":WGEN<w>:VOLTage:OFFSet" on page 1272 ▪ ":WGEN<w>:VOLTage:HIGH" on page 1270 ▪ ":WGEN<w>:VOLTage:LOW" on page 1271 ▪ ":WGEN<w>:FUNction:SQUare:DCYCLE" on page 1249 The duty cycle can be adjusted from 20% to 80%.	100 mHz to 10 MHz	20 mVpp to 10 Vpp	±5.00 V

Waveform Type	Characteristics	Frequency Range	Max. Amplitude ² (High-Z) ¹	Offset ² (High-Z) ¹
RAMP	<p>Use these commands to set the ramp signal parameters:</p> <ul style="list-style-type: none"> ▪ ":WGEN<w>:FREQuency" on page 1242 ▪ ":WGEN<w>:PERiod" on page 1267 ▪ ":WGEN<w>:VOLTage" on page 1269 ▪ ":WGEN<w>:VOLTage:OFFSet" on page 1272 ▪ ":WGEN<w>:VOLTage:HIGH" on page 1270 ▪ ":WGEN<w>:VOLTage:LOW" on page 1271 ▪ ":WGEN<w>:FUNCTion:RAMP:SYMMetry" on page 1248 <p>Symmetry represents the amount of time per cycle that the ramp waveform is rising and can be adjusted from 0% to 100%.</p>	100 mHz to 200 kHz	20 mVpp to 10 Vpp	±5.00 V
PULSe	<p>Use these commands to set the pulse signal parameters:</p> <ul style="list-style-type: none"> ▪ ":WGEN<w>:FREQuency" on page 1242 ▪ ":WGEN<w>:PERiod" on page 1267 ▪ ":WGEN<w>:VOLTage" on page 1269 ▪ ":WGEN<w>:VOLTage:OFFSet" on page 1272 ▪ ":WGEN<w>:VOLTage:HIGH" on page 1270 ▪ ":WGEN<w>:VOLTage:LOW" on page 1271 ▪ ":WGEN<w>:FUNCTion:PULSe:WIDTh" on page 1247 <p>The pulse width can be adjusted from 20 ns to the period minus 20 ns.</p>	100 mHz to 10 MHz.	20 mVpp to 10 Vpp	±5.00 V
DC	<p>Use this command to set the DC level:</p> <ul style="list-style-type: none"> ▪ ":WGEN<w>:VOLTage:OFFSet" on page 1272 	n/a	n/a	±10.00 V
NOISe	<p>Use these commands to set the noise signal parameters:</p> <ul style="list-style-type: none"> ▪ ":WGEN<w>:VOLTage" on page 1269 ▪ ":WGEN<w>:VOLTage:OFFSet" on page 1272 ▪ ":WGEN<w>:VOLTage:HIGH" on page 1270 ▪ ":WGEN<w>:VOLTage:LOW" on page 1271 	n/a	20 mVpp to 10 Vpp	±5.00 V

Waveform Type	Characteristics	Frequency Range	Max. Amplitude ² (High-Z) ¹	Offset ² (High-Z) ¹
SINC	Use these commands to set the sine cardinal signal parameters: <ul style="list-style-type: none"> ▪ ":WGEN<w>:FREQuency" on page 1242 ▪ ":WGEN<w>:PERiod" on page 1267 ▪ ":WGEN<w>:VOLTagE" on page 1269 ▪ ":WGEN<w>:VOLTagE:OFFSet" on page 1272 	100 mHz to 1 MHz	20 mVpp to 9 Vpp	±2.50 V
EXPRise	Use these commands to set the exponential rise signal parameters: <ul style="list-style-type: none"> ▪ ":WGEN<w>:FREQuency" on page 1242 ▪ ":WGEN<w>:PERiod" on page 1267 ▪ ":WGEN<w>:VOLTagE" on page 1269 ▪ ":WGEN<w>:VOLTagE:OFFSet" on page 1272 ▪ ":WGEN<w>:VOLTagE:HIGH" on page 1270 ▪ ":WGEN<w>:VOLTagE:LOW" on page 1271 	100 mHz to 5 MHz	20 mVpp to 10 Vpp	±5.00 V
EXPFall	Use these commands to set the exponential fall signal parameters: <ul style="list-style-type: none"> ▪ ":WGEN<w>:FREQuency" on page 1242 ▪ ":WGEN<w>:PERiod" on page 1267 ▪ ":WGEN<w>:VOLTagE" on page 1269 ▪ ":WGEN<w>:VOLTagE:OFFSet" on page 1272 ▪ ":WGEN<w>:VOLTagE:HIGH" on page 1270 ▪ ":WGEN<w>:VOLTagE:LOW" on page 1271 	100 mHz to 5 MHz	20 mVpp to 10 Vpp	±5.00 V
CARDiac	Use these commands to set the cardiac signal parameters: <ul style="list-style-type: none"> ▪ ":WGEN<w>:FREQuency" on page 1242 ▪ ":WGEN<w>:PERiod" on page 1267 ▪ ":WGEN<w>:VOLTagE" on page 1269 ▪ ":WGEN<w>:VOLTagE:OFFSet" on page 1272 	100 mHz to 200 kHz	20 mVpp to 9 Vpp	±2.50 V
GAUSSian	Use these commands to set the gaussian pulse signal parameters: <ul style="list-style-type: none"> ▪ ":WGEN<w>:FREQuency" on page 1242 ▪ ":WGEN<w>:PERiod" on page 1267 ▪ ":WGEN<w>:VOLTagE" on page 1269 ▪ ":WGEN<w>:VOLTagE:OFFSet" on page 1272 	100 mHz to 5 MHz	20 mVpp to 7.5 Vpp	±2.50 V

Waveform Type	Characteristics	Frequency Range	Max. Amplitude ² (High-Z) ¹	Offset ² (High-Z) ¹
ARbitrary	Use these commands to set the arbitrary signal parameters: <ul style="list-style-type: none"> ▪ ":WGEN<w>:FREQuency" on page 1242 ▪ ":WGEN<w>:PERiod" on page 1267 ▪ ":WGEN<w>:VOLTage" on page 1269 ▪ ":WGEN<w>:VOLTage:OFFSet" on page 1272 ▪ ":WGEN<w>:VOLTage:HIGH" on page 1270 ▪ ":WGEN<w>:VOLTage:LOW" on page 1271 	100 mHz to 12 MHz	20 mVpp to 10 Vpp	±5.00 V
<p>¹When the output load is 50 Ω, these values are halved.</p> <p>²The minimum amplitude is limited to 40 mVpp if the offset is greater than 500 mV or less than -500 mV. Likewise, the offset is limited to +/-500 mV if the amplitude is less than 40 mVpp.</p>				

Query Syntax :WGEN<w>:FUNctIon?

The :WGEN<w>:FUNctIon? query returns the currently selected signal type.

Return Format <signal><NL>

<signal> ::= {SIN | SQU | RAMP | PULS | DC | NOIS | SINC | EXPR | EXPF
| CARD | GAUS | ARB}

- See Also**
- **"Introduction to :WGEN<w> Commands"** on page 1234
 - **":WGEN<w>:MODulation:NOISe"** on page 1258

:WGEN<w>:FUNCTION:PULSE:WIDTH

N (see [page 1384](#))

Command Syntax :WGEN<w>:FUNCTION:PULSE:WIDTH <width>

<w> ::= 1 or 2 in NR1 format

<width> ::= pulse width in seconds in NR3 format

For Pulse waveforms, the :WGEN<w>:FUNCTION:PULSE:WIDTH command specifies the width of the pulse.

The pulse width can be adjusted from 20 ns to the period minus 20 ns.

Query Syntax :WGEN<w>:FUNCTION:PULSE:WIDTH?

The :WGEN<w>:FUNCTION:PULSE:WIDTH? query returns the currently set pulse width.

Return Format <width><NL>

<width> ::= pulse width in seconds in NR3 format

- See Also**
- ["Introduction to :WGEN<w> Commands"](#) on page 1234
 - [":WGEN<w>:FUNCTION"](#) on page 1243

:WGEN<w>:FUNCTION:RAMP:SYMMetry

N (see [page 1384](#))

Command Syntax :WGEN<w>:FUNCTION:RAMP:SYMMetry <percent>

<w> ::= 1 or 2 in NR1 format

<percent> ::= symmetry percentage from 0% to 100% in NR3 format

For Ramp waveforms, the :WGEN<w>:FUNCTION:RAMP:SYMMetry command specifies the symmetry of the waveform.

Symmetry represents the amount of time per cycle that the ramp waveform is rising.

Query Syntax :WGEN<w>:FUNCTION:RAMP:SYMMetry?

The :WGEN<w>:FUNCTION:RAMP:SYMMetry? query returns the currently set ramp symmetry.

Return Format <percent><NL>

<percent> ::= symmetry percentage from 0% to 100% in NR3 format

- See Also**
- ["Introduction to :WGEN<w> Commands"](#) on page 1234
 - [":WGEN<w>:FUNCTION"](#) on page 1243

:WGEN<w>:FUNCTION:SQUare:DCYClE

N (see [page 1384](#))

Command Syntax :WGEN<w>:FUNCTION:SQUare:DCYClE <percent>

<w> ::= 1 or 2 in NR1 format

<percent> ::= duty cycle percentage from 20% to 80% in NR3 format

For Square waveforms, the :WGEN<w>:FUNCTION:SQUare:DCYClE command specifies the square wave duty cycle.

Duty cycle is the percentage of the period that the waveform is high.

Query Syntax :WGEN<w>:FUNCTION:SQUare:DCYClE?

The :WGEN<w>:FUNCTION:SQUare:DCYClE? query returns the currently set square wave duty cycle.

Return Format <percent><NL>

<percent> ::= duty cycle percentage from 20% to 80% in NR3 format

- See Also**
- ["Introduction to :WGEN<w> Commands"](#) on page 1234
 - [":WGEN<w>:FUNCTION"](#) on page 1243

:WGEN<w>:MODulation:AM:DEPTH

N (see [page 1384](#))

Command Syntax :WGEN<w>:MODulation:AM:DEPTH <percent>

<w> ::= 1 in NR1 format

<percent> ::= AM depth percentage from 0% to 100% in NR1 format

The :WGEN<w>:MODulation:AM:DEPTH command specifies the amount of amplitude modulation.

AM Depth refers to the portion of the amplitude range that will be used by the modulation. For example, a depth setting of 80% causes the output amplitude to vary from 10% to 90% (90% – 10% = 80%) of the original amplitude as the modulating signal goes from its minimum to maximum amplitude.

Query Syntax :WGEN<w>:MODulation:AM:DEPTH?

The :WGEN<w>:MODulation:AM:DEPTH? query returns the AM depth percentage setting.

Return Format <percent><NL>

<percent> ::= AM depth percentage from 0% to 100% in NR1 format

- See Also**
- [":WGEN<w>:MODulation:AM:FREQUENCY"](#) on page 1251
 - [":WGEN<w>:MODulation:FM:DEVIATION"](#) on page 1252
 - [":WGEN<w>:MODulation:FM:FREQUENCY"](#) on page 1253
 - [":WGEN<w>:MODulation:FSKey:FREQUENCY"](#) on page 1254
 - [":WGEN<w>:MODulation:FSKey:RATE"](#) on page 1255
 - [":WGEN<w>:MODulation:FUNCTION"](#) on page 1256
 - [":WGEN<w>:MODulation:FUNCTION:RAMP:SYMMETRY"](#) on page 1257
 - [":WGEN<w>:MODulation:STATE"](#) on page 1259
 - [":WGEN<w>:MODulation:TYPE"](#) on page 1260

:WGEN<w>:MODulation:AM:FREQuency

N (see [page 1384](#))

Command Syntax :WGEN<w>:MODulation:AM:FREQuency <frequency>

<w> ::= 1 in NR1 format

<frequency> ::= modulating waveform frequency in Hz in NR3 format

The :WGEN<w>:MODulation:AM:FREQuency command specifies the frequency of the modulating signal.

Query Syntax :WGEN<w>:MODulation:AM:FREQuency?

The :WGEN<w>:MODulation:AM:FREQuency? query returns the frequency of the modulating signal.

Return Format <frequency><NL>

<frequency> ::= modulating waveform frequency in Hz in NR3 format

- See Also**
- [":WGEN<w>:MODulation:AM:DEPTH"](#) on page 1250
 - [":WGEN<w>:MODulation:FM:DEVIation"](#) on page 1252
 - [":WGEN<w>:MODulation:FM:FREQuency"](#) on page 1253
 - [":WGEN<w>:MODulation:FSKey:FREQuency"](#) on page 1254
 - [":WGEN<w>:MODulation:FSKey:RATE"](#) on page 1255
 - [":WGEN<w>:MODulation:FUNCTion"](#) on page 1256
 - [":WGEN<w>:MODulation:FUNCTion:RAMP:SYMMetry"](#) on page 1257
 - [":WGEN<w>:MODulation:STATe"](#) on page 1259
 - [":WGEN<w>:MODulation:TYPE"](#) on page 1260

:WGEN<w>:MODulation:FM:DEVIation

N (see [page 1384](#))

Command Syntax :WGEN<w>:MODulation:FM:DEVIation <frequency>

<w> ::= 1 in NR1 format

<frequency> ::= frequency deviation in Hz in NR3 format

The :WGEN<w>:MODulation:FM:DEVIation command specifies the frequency deviation from the original carrier signal frequency.

When the modulating signal is at its maximum amplitude, the output frequency is the carrier signal frequency plus the deviation amount, and when the modulating signal is at its minimum amplitude, the output frequency is the carrier signal frequency minus the deviation amount.

The frequency deviation cannot be greater than the original carrier signal frequency.

Also, the sum of the original carrier signal frequency and the frequency deviation must be less than or equal to the maximum frequency for the selected waveform generator function plus 100 kHz.

Query Syntax :WGEN<w>:MODulation:FM:DEVIation?

The :WGEN<w>:MODulation:FM:DEVIation? query returns the frequency deviation setting.

Return Format <frequency><NL>

<frequency> ::= frequency deviation in Hz in NR3 format

- See Also**
- **":WGEN<w>:MODulation:AM:DEPTH"** on page 1250
 - **":WGEN<w>:MODulation:AM:FREQuency"** on page 1251
 - **":WGEN<w>:MODulation:FM:FREQuency"** on page 1253
 - **":WGEN<w>:MODulation:FSKey:FREQuency"** on page 1254
 - **":WGEN<w>:MODulation:FSKey:RATE"** on page 1255
 - **":WGEN<w>:MODulation:FUNCTion"** on page 1256
 - **":WGEN<w>:MODulation:FUNCTion:RAMP:SYMMetry"** on page 1257
 - **":WGEN<w>:MODulation:STATe"** on page 1259
 - **":WGEN<w>:MODulation:TYPE"** on page 1260

:WGEN<w>:MODulation:FM:FREQuency

N (see [page 1384](#))

Command Syntax :WGEN<w>:MODulation:FM:FREQuency <frequency>

<w> ::= 1 in NR1 format

<frequency> ::= modulating waveform frequency in Hz in NR3 format

The :WGEN<w>:MODulation:FM:FREQuency command specifies the frequency of the modulating signal.

Query Syntax :WGEN<w>:MODulation:FM:FREQuency?

The :WGEN<w>:MODulation:FM:FREQuency? query returns the frequency of the modulating signal.

Return Format <frequency><NL>

<frequency> ::= modulating waveform frequency in Hz in NR3 format

- See Also**
- [":WGEN<w>:MODulation:AM:DEPTH"](#) on page 1250
 - [":WGEN<w>:MODulation:AM:FREQuency"](#) on page 1251
 - [":WGEN<w>:MODulation:FM:DEViation"](#) on page 1252
 - [":WGEN<w>:MODulation:FSKey:FREQuency"](#) on page 1254
 - [":WGEN<w>:MODulation:FSKey:RATE"](#) on page 1255
 - [":WGEN<w>:MODulation:FUNCTion"](#) on page 1256
 - [":WGEN<w>:MODulation:FUNCTion:RAMP:SYMMetry"](#) on page 1257
 - [":WGEN<w>:MODulation:STATe"](#) on page 1259
 - [":WGEN<w>:MODulation:TYPE"](#) on page 1260

:WGEN<w>:MODulation:FSKey:FREQuency

N (see [page 1384](#))

Command Syntax :WGEN<w>:MODulation:FSKey:FREQuency <frequency>

<w> ::= 1 in NR1 format

<frequency> ::= hop frequency in Hz in NR3 format

The :WGEN<w>:MODulation:FSKey:FREQuency command specifies the "hop frequency".

The output frequency "shifts" between the original carrier frequency and this "hop frequency".

Query Syntax :WGEN<w>:MODulation:FSKey:FREQuency?

The :WGEN<w>:MODulation:FSKey:FREQuency? query returns the "hop frequency" setting.

Return Format <frequency><NL>

<frequency> ::= hop frequency in Hz in NR3 format

- See Also**
- [":WGEN<w>:MODulation:AM:DEPTH"](#) on page 1250
 - [":WGEN<w>:MODulation:AM:FREQuency"](#) on page 1251
 - [":WGEN<w>:MODulation:FM:DEVIation"](#) on page 1252
 - [":WGEN<w>:MODulation:FM:FREQuency"](#) on page 1253
 - [":WGEN<w>:MODulation:FSKey:RATE"](#) on page 1255
 - [":WGEN<w>:MODulation:FUNCTion"](#) on page 1256
 - [":WGEN<w>:MODulation:FUNCTion:RAMP:SYMMetry"](#) on page 1257
 - [":WGEN<w>:MODulation:STATe"](#) on page 1259
 - [":WGEN<w>:MODulation:TYPE"](#) on page 1260

:WGEN<w>:MODulation:FSKey:RATE

N (see [page 1384](#))

Command Syntax :WGEN<w>:MODulation:FSKey:RATE <rate>

<w> ::= 1 in NR1 format

<rate> ::= FSK modulation rate in Hz in NR3 format

The :WGEN<w>:MODulation:FSKey:RATE command specifies the rate at which the output frequency "shifts".

The FSK rate specifies a digital square wave modulating signal.

Query Syntax :WGEN<w>:MODulation:FSKey:RATE?

The :WGEN<w>:MODulation:FSKey:RATE? query returns the FSK rate setting.

Return Format <rate><NL>

<rate> ::= FSK modulation rate in Hz in NR3 format

- See Also**
- [":WGEN<w>:MODulation:AM:DEPTH"](#) on page 1250
 - [":WGEN<w>:MODulation:AM:FREQUENCY"](#) on page 1251
 - [":WGEN<w>:MODulation:FM:DEVIATION"](#) on page 1252
 - [":WGEN<w>:MODulation:FM:FREQUENCY"](#) on page 1253
 - [":WGEN<w>:MODulation:FSKey:FREQUENCY"](#) on page 1254
 - [":WGEN<w>:MODulation:FUNCTION"](#) on page 1256
 - [":WGEN<w>:MODulation:FUNCTION:RAMP:SYMMETRY"](#) on page 1257
 - [":WGEN<w>:MODulation:STATE"](#) on page 1259
 - [":WGEN<w>:MODulation:TYPE"](#) on page 1260

:WGEN<w>:MODulation:FUNction

N (see [page 1384](#))

Command Syntax :WGEN<w>:MODulation:FUNction <shape>

<w> ::= 1 in NR1 format

<shape> ::= {SINusoid | SQUare| RAMP}

The :WGEN<w>:MODulation:FUNction command specifies the shape of the modulating signal.

When the RAMP shape is selected, you can specify the amount of time per cycle that the ramp waveform is rising with the :WGEN<w>:MODulation:FUNction:RAMP:SYMMetry command.

This command applies to AM and FM modulation. (The FSK modulation signal is a square wave shape.)

Query Syntax :WGEN<w>:MODulation:FUNction?

The :WGEN<w>:MODulation:FUNction? query returns the specified modulating signal shape.

Return Format <shape><NL>

<shape> ::= {SIN | SQU| RAMP}

- See Also**
- [":WGEN<w>:MODulation:AM:DEPTH"](#) on page 1250
 - [":WGEN<w>:MODulation:AM:FREQuency"](#) on page 1251
 - [":WGEN<w>:MODulation:FM:DEVIation"](#) on page 1252
 - [":WGEN<w>:MODulation:FM:FREQuency"](#) on page 1253
 - [":WGEN<w>:MODulation:FSKey:FREQuency"](#) on page 1254
 - [":WGEN<w>:MODulation:FSKey:RATE"](#) on page 1255
 - [":WGEN<w>:MODulation:FUNction:RAMP:SYMMetry"](#) on page 1257
 - [":WGEN<w>:MODulation:STATE"](#) on page 1259
 - [":WGEN<w>:MODulation:TYPE"](#) on page 1260

:WGEN<w>:MODulation:FUNcTion:RAMP:SYMMetry

N (see [page 1384](#))

Command Syntax :WGEN<w>:MODulation:FUNcTion:RAMP:SYMMetry <percent>

<w> ::= 1 in NR1 format

<percent> ::= symmetry percentage from 0% to 100% in NR1 format

The :WGEN<w>:MODulation:FUNcTion:RAMP:SYMMetry command specifies the amount of time per cycle that the ramp waveform is rising. The ramp modulating waveform shape is specified with the :WGEN<w>:MODulation:FUNcTion command.

Query Syntax :WGEN<w>:MODulation:FUNcTion:RAMP:SYMMetry?

The :WGEN<w>:MODulation:FUNcTion:RAMP:SYMMetry? query returns ramp symmetry percentage setting.

Return Format <percent><NL>

<percent> ::= symmetry percentage from 0% to 100% in NR1 format

- See Also**
- [":WGEN<w>:MODulation:AM:DEPTH"](#) on page 1250
 - [":WGEN<w>:MODulation:AM:FREQuency"](#) on page 1251
 - [":WGEN<w>:MODulation:FM:DEViation"](#) on page 1252
 - [":WGEN<w>:MODulation:FM:FREQuency"](#) on page 1253
 - [":WGEN<w>:MODulation:FSKey:FREQuency"](#) on page 1254
 - [":WGEN<w>:MODulation:FSKey:RATE"](#) on page 1255
 - [":WGEN<w>:MODulation:FUNcTion"](#) on page 1256
 - [":WGEN<w>:MODulation:STATe"](#) on page 1259
 - [":WGEN<w>:MODulation:TYPE"](#) on page 1260

:WGEN<w>:MODulation:NOISe

N (see [page 1384](#))

Command Syntax :WGEN<w>:MODulation:NOISe <percent>

<w> ::= 1 or 2 in NR1 format

<percent> ::= 0 to 100

The :WGEN<w>:MODulation:NOISe command adds noise to the currently selected signal. The sum of the amplitude between the original signal and injected noise is limited to the regular amplitude limit (for example, 5 Vpp in 1 MOhm), so the range for <percent> varies according to current amplitude.

Note that adding noise affects edge triggering on the waveform generator source as well as the waveform generator sync pulse output signal (which can be sent to TRIG OUT). This is because the trigger comparator is located after the noise source.

Query Syntax :WGEN<w>:MODulation:NOISe?

The :WGEN<w>:MODulation:NOISe query returns the percent of added noise.

Return Format <percent><NL>

<percent> ::= 0 to 100

See Also • [":WGEN<w>:FUNCTION"](#) on page 1243

:WGEN<w>:MODulation:STATe

N (see [page 1384](#))

Command Syntax :WGEN<w>:MODulation:STATe <setting>

<w> ::= 1 in NR1 format

<setting> ::= {{OFF | 0} | {ON | 1}}

The :WGEN<w>:MODulation:STATe command enables or disables modulated waveform generator output.

You can enable modulation for all waveform generator function types except pulse, DC, and noise.

Query Syntax :WGEN<w>:MODulation:STATe?

The :WGEN<w>:MODulation:STATe? query returns whether the modulated waveform generator output is enabled or disabled.

Return Format <setting><NL>

<setting> ::= {0 | 1}

- See Also**
- [":WGEN<w>:MODulation:AM:DEPTH"](#) on page 1250
 - [":WGEN<w>:MODulation:AM:FREQUENCY"](#) on page 1251
 - [":WGEN<w>:MODulation:FM:DEVIATION"](#) on page 1252
 - [":WGEN<w>:MODulation:FM:FREQUENCY"](#) on page 1253
 - [":WGEN<w>:MODulation:FSKey:FREQUENCY"](#) on page 1254
 - [":WGEN<w>:MODulation:FSKey:RATE"](#) on page 1255
 - [":WGEN<w>:MODulation:FUNCTION"](#) on page 1256
 - [":WGEN<w>:MODulation:FUNCTION:RAMP:SYMMETRY"](#) on page 1257
 - [":WGEN<w>:MODulation:TYPE"](#) on page 1260

:WGEN<w>:MODulation:TYPE**N** (see [page 1384](#))**Command Syntax** :WGEN<w>:MODulation:TYPE <type>

<w> ::= 1 in NR1 format

<type> ::= {AM | FM | FSK}

The :WGEN<w>:MODulation:TYPE command selects the modulation type:

- AM (amplitude modulation) – the amplitude of the original carrier signal is modified according to the amplitude of the modulating signal.

Use the :WGEN<w>:MODulation:AM:FREQUENCY command to set the modulating signal frequency.

Use the :WGEN<w>:MODulation:AM:DEPTH command to specify the amount of amplitude modulation.

- FM (frequency modulation) – the frequency of the original carrier signal is modified according to the amplitude of the modulating signal.

Use the :WGEN<w>:MODulation:FM:FREQUENCY command to set the modulating signal frequency.

Use the :WGEN<w>:MODulation:FM:DEVIATION command to specify the frequency deviation from the original carrier signal frequency.

- FSK (frequency-shift keying modulation) – the output frequency "shifts" between the original carrier frequency and a "hop frequency" at the specified FSK rate.

The FSK rate specifies a digital square wave modulating signal.

Use the :WGEN<w>:MODulation:FSKey:FREQUENCY command to specify the "hop frequency".

Use the :WGEN<w>:MODulation:FSKey:RATE command to specify the rate at which the output frequency "shifts".

Query Syntax :WGEN<w>:MODulation:TYPE?

The :WGEN<w>:MODulation:TYPE? query returns the selected modulation type.

Return Format <type><NL>

<type> ::= {AM | FM | FSK}

- See Also**
- [":WGEN<w>:MODulation:AM:DEPTH"](#) on page 1250
 - [":WGEN<w>:MODulation:AM:FREQUENCY"](#) on page 1251
 - [":WGEN<w>:MODulation:FM:DEVIATION"](#) on page 1252
 - [":WGEN<w>:MODulation:FM:FREQUENCY"](#) on page 1253
 - [":WGEN<w>:MODulation:FSKey:FREQUENCY"](#) on page 1254

- **":WGEN<w>:MODulation:FSKey:RATE"** on page 1255
- **":WGEN<w>:MODulation:FUNCTion"** on page 1256
- **":WGEN<w>:MODulation:FUNCTion:RAMP:SYMMetry"** on page 1257
- **":WGEN<w>:MODulation:STATe"** on page 1259

:WGEN<w>:OUTPut

N (see [page 1384](#))

Command Syntax :WGEN<w>:OUTPut <on_off>

<w> ::= 1 or 2 in NR1 format

<on_off> ::= {1 | ON} | {0 | OFF}

The :WGEN<w>:OUTPut command specifies whether the waveform generator signal output is ON (1) or OFF (0).

Query Syntax :WGEN<w>:OUTPut?

The :WGEN<w>:OUTPut? query returns the current state of the waveform generator output setting.

Return Format <on_off><NL>

<on_off> ::= {1 | 0}

See Also • ["Introduction to :WGEN<w> Commands"](#) on page 1234

:WGEN<w>:OUTPut:LOAD

N (see [page 1384](#))

Command Syntax :WGEN<w>:OUTPut:LOAD <impedance>

<w> ::= 1 or 2 in NR1 format

<impedance> ::= {ONEMeg | FIFTy}

The :WGEN<w>:OUTPut:LOAD command selects the expected output load impedance.

The output impedance of the Gen Out BNC is fixed at 50 ohms. However, the output load selection lets the waveform generator display the correct amplitude and offset levels for the expected output load.

If the actual load impedance is different than the selected value, the displayed amplitude and offset levels will be incorrect.

Query Syntax :WGEN<w>:OUTPut:LOAD?

The :WGEN<w>:OUTPut:LOAD? query returns the current expected output load impedance.

Return Format <impedance><NL>

<impedance> ::= {ONEM | FIFT}

See Also • ["Introduction to :WGEN<w> Commands"](#) on page 1234

:WGEN<w>:OUTPut:MODE

N (see [page 1384](#))

Command Syntax :WGEN<w>:OUTPut:MODE <mode>
 <mode> ::= {NORMal | SINGle}

The :WGEN<w>:OUTPut:MODE command specifies whether the defined waveform is output continuously or as a single cycle (single-shot):

- NORMal – the defined waveform is output continuously.
- SINGle – one cycle of the defined waveform is output when you send the :WGEN<w>:OUTPut:SINGle command.

Not all waveform types allow single-shot output.

Query Syntax :WGEN<w>:OUTPut:MODE?

The :WGEN<w>:OUTPut:MODE? query returns the output mode setting.

Return Format <mode><NL>
 <mode> ::= {NORMal | SINGle}

See Also • [":WGEN<w>:OUTPut:SINGle"](#) on page 1266

:WGEN<w>:OUTPut:POLarity

N (see [page 1384](#))

Command Syntax :WGEN<w>:OUTPut:POLarity <polarity>

<w> ::= 1 or 2 in NR1 format

<polarity> ::= {NORMAL | INVERTed}

The :WGEN<w>:OUTPut:POLarity command specifies whether the waveform generator output is inverted..

Query Syntax :WGEN<w>:OUTPut:POLarity?

The :WGEN<w>:OUTPut:POLarity? query returns the specified output polarity.

Return Format <polarity><NL>

<polarity> ::= {NORM | INV}

See Also • ["Introduction to :WGEN<w> Commands"](#) on page 1234

:WGEN<w>:OUTPut:SINGle

N (see [page 1384](#))

Command Syntax :WGEN<w>:OUTPut:SINGle

When the single-shot output mode is selected (by the :WGEN<w>:OUTPut:MODE command), the :WGEN<w>:OUTPut:SINGle command causes a single cycle of the defined waveform to be output.

Sending this command multiple times will interrupt a slow signal output before the cycle is completed.

See Also • [":WGEN<w>:OUTPut:MODE"](#) on page 1264

:WGEN<w>:PERiod

N (see [page 1384](#))

Command Syntax :WGEN<w>:PERiod <period>

<w> ::= 1 or 2 in NR1 format

<period> ::= period in seconds in NR3 format

For all waveforms except Noise and DC, the :WGEN<w>:PERiod command specifies the period of the waveform.

You can also specify the period indirectly using the :WGEN<w>:FREQuency command.

Query Syntax :WGEN<w>:PERiod?

The :WGEN<w>:PERiod? query returns the currently set waveform generator period.

Return Format <period><NL>

<period> ::= period in seconds in NR3 format

- See Also**
- ["Introduction to :WGEN<w> Commands"](#) on page 1234
 - [":WGEN<w>:FUNction"](#) on page 1243
 - [":WGEN<w>:FREQuency"](#) on page 1242

:WGEN<w>:RST

N (see [page 1384](#))

Command Syntax :WGEN<w>:RST

<w> ::= 1 or 2 in NR1 format

The :WGEN<w>:RST command restores the waveform generator factory default settings (1 kHz sine wave, 500 mVpp, 0 V offset).

- See Also**
- ["Introduction to :WGEN<w> Commands"](#) on page 1234
 - [":WGEN<w>:FUNCTION"](#) on page 1243
 - [":WGEN<w>:FREQUENCY"](#) on page 1242

:WGEN<w>:VOLTage

N (see [page 1384](#))

Command Syntax :WGEN<w>:VOLTage <amplitude>

<w> ::= 1 or 2 in NR1 format

<amplitude> ::= amplitude in volts in NR3 format

For all waveforms except DC, the :WGEN<w>:VOLTage command specifies the waveform's amplitude. Use the :WGEN<w>:VOLTage:OFFSet command to specify the offset voltage or DC level.

You can also specify the amplitude and offset indirectly using the :WGEN<w>:VOLTage:HIGH and :WGEN<w>:VOLTage:LOW commands. For example, an amplitude of 5 V and an offset of 1 V is the same as a high-level voltage of 4 V and a low-level voltage of -1 V.

NOTE

When the amplitude is below 40 mV, the offset is limited to ± 500 mV.

Query Syntax :WGEN<w>:VOLTage?

The :WGEN<w>:VOLTage? query returns the currently specified waveform amplitude.

Return Format <amplitude><NL>

<amplitude> ::= amplitude in volts in NR3 format

- See Also**
- ["Introduction to :WGEN<w> Commands"](#) on page 1234
 - [":WGEN<w>:FUNCTION"](#) on page 1243
 - [":WGEN<w>:VOLTage:OFFSet"](#) on page 1272
 - [":WGEN<w>:VOLTage:HIGH"](#) on page 1270
 - [":WGEN<w>:VOLTage:LOW"](#) on page 1271

:WGEN<w>:VOLTage:HIGH

N (see [page 1384](#))

Command Syntax :WGEN<w>:VOLTage:HIGH <high>

<w> ::= 1 or 2 in NR1 format

<high> ::= high-level voltage in volts, in NR3 format

For all waveforms except DC, the :WGEN<w>:VOLTage:HIGH command specifies the waveform's high-level voltage. Use the :WGEN<w>:VOLTage:LOW command to specify the low-level voltage.

You can also specify the high-level and low-level voltages indirectly using the :WGEN<w>:VOLTage and :WGEN<w>:VOLTage:OFFSet commands. For example, a high-level voltage of 4 V and a low-level voltage of -1 V is the same as an amplitude of 5 V and an offset of 1 V.

NOTE

When the amplitude is below 40 mV, the offset is limited to ± 500 mV.

Query Syntax :WGEN<w>:VOLTage:HIGH?

The :WGEN<w>:VOLTage:HIGH? query returns the currently specified waveform high-level voltage.

Return Format <high><NL>

<high> ::= high-level voltage in volts, in NR3 format

- See Also**
- ["Introduction to :WGEN<w> Commands"](#) on page 1234
 - [":WGEN<w>:FUNction"](#) on page 1243
 - [":WGEN<w>:VOLTage:LOW"](#) on page 1271
 - [":WGEN<w>:VOLTage"](#) on page 1269
 - [":WGEN<w>:VOLTage:OFFSet"](#) on page 1272

:WGEN<w>:VOLTage:LOW

N (see [page 1384](#))

Command Syntax :WGEN<w>:VOLTage:LOW <low>

<w> ::= 1 or 2 in NR1 format

<low> ::= low-level voltage in volts, in NR3 format

For all waveforms except DC, the :WGEN<w>:VOLTage:LOW command specifies the waveform's low-level voltage. Use the :WGEN<w>:VOLTage:HIGh command to specify the high-level voltage.

You can also specify the high-level and low-level voltages indirectly using the :WGEN<w>:VOLTage and :WGEN<w>:VOLTage:OFFSet commands. For example, a high-level voltage of 4 V and a low-level voltage of -1 V is the same as an amplitude of 5 V and an offset of 1 V.

NOTE

When the amplitude is below 40 mV, the offset is limited to ± 500 mV.

Query Syntax :WGEN<w>:VOLTage:LOW?

The :WGEN<w>:VOLTage:LOW? query returns the currently specified waveform low-level voltage.

Return Format <low><NL>

<low> ::= low-level voltage in volts, in NR3 format

- See Also**
- ["Introduction to :WGEN<w> Commands"](#) on page 1234
 - [":WGEN<w>:FUNction"](#) on page 1243
 - [":WGEN<w>:VOLTage:LOW"](#) on page 1271
 - [":WGEN<w>:VOLTage"](#) on page 1269
 - [":WGEN<w>:VOLTage:OFFSet"](#) on page 1272

:WGEN<w>:VOLTage:OFFSet

N (see [page 1384](#))

Command Syntax :WGEN<w>:VOLTage:OFFSet <offset>

<w> ::= 1 or 2 in NR1 format

<offset> ::= offset in volts in NR3 format

The :WGEN<w>:VOLTage:OFFSet command specifies the waveform's offset voltage or the DC level. Use the :WGEN<w>:VOLTage command to specify the amplitude.

You can also specify the amplitude and offset indirectly using the :WGEN<w>:VOLTage:HIGH and :WGEN<w>:VOLTage:LOW commands. For example, an amplitude of 5 V and an offset of 1 V is the same as a high-level voltage of 4 V and a low-level voltage of -1 V.

NOTE

When the amplitude is below 40 mV, the offset is limited to ± 500 mV.

Query Syntax :WGEN<w>:VOLTage:OFFSet?

The :WGEN<w>:VOLTage:OFFSet? query returns the currently specified waveform offset voltage.

Return Format <offset><NL>

<offset> ::= offset in volts in NR3 format

- See Also**
- ["Introduction to :WGEN<w> Commands"](#) on page 1234
 - [":WGEN<w>:FUNCTION"](#) on page 1243
 - [":WGEN<w>:VOLTage"](#) on page 1269
 - [":WGEN<w>:VOLTage:HIGH"](#) on page 1270
 - [":WGEN<w>:VOLTage:LOW"](#) on page 1271

36 :WMEMemory<r> Commands

Control reference waveforms.

Table 158: :WMEMemory<r> Commands Summary

Command	Query	Options and Query Returns
:WMEMemory<r>:CLEAr (see page 1275)	n/a	<r> ::= 1 to (# ref waveforms) in NR1 format
:WMEMemory<r>:DISPlay { {0 OFF} {1 ON} } (see page 1276)	:WMEMemory<r>:DISPlay? (see page 1276)	<r> ::= 1 to (# ref waveforms) in NR1 format {0 1}
:WMEMemory<r>:LABel <string> (see page 1277)	:WMEMemory<r>:LABel? (see page 1277)	<r> ::= 1 to (# ref waveforms) in NR1 format <string> ::= any series of 10 or less ASCII characters enclosed in quotation marks
:WMEMemory<r>:SAVE <source> (see page 1278)	n/a	<r> ::= 1 to (# ref waveforms) in NR1 format <source> ::= {CHANnel<n> FUNCTION<m> MATH<m>} <n> ::= 1 to (# analog channels) in NR1 format <m> ::= 1 to (# math functions) in NR1 format NOTE: Math functions whose x-axis is not frequency can be saved as reference waveforms.
:WMEMemory<r>:SKEW <skew> (see page 1279)	:WMEMemory<r>:SKEW? (see page 1279)	<r> ::= 1 to (# ref waveforms) in NR1 format <skew> ::= time in seconds in NR3 format
:WMEMemory<r>:YOFFset <offset>[suffix] (see page 1280)	:WMEMemory<r>:YOFFset? (see page 1280)	<r> ::= 1 to (# ref waveforms) in NR1 format <offset> ::= vertical offset value in NR3 format [suffix] ::= {V mV}

Table 158: WMEemory<r> Commands Summary (continued)

Command	Query	Options and Query Returns
:WMEemory<r>:YRANge <range>[suffix] (see page 1281)	:WMEemory<r>:YRANge? (see page 1281)	<r> ::= 1 to (# ref waveforms) in NR1 format <range> ::= vertical full-scale range value in NR3 format [suffix] ::= {V mV}
:WMEemory<r>:YSCale <scale>[suffix] (see page 1282)	:WMEemory<r>:YSCale? (see page 1282)	<r> ::= 1 to (# ref waveforms) in NR1 format <scale> ::= vertical units per division value in NR3 format [suffix] ::= {V mV}

:WMEemory<r>:CLEar

N (see [page 1384](#))

Command Syntax :WMEemory<r>:CLEar

<r> ::= 1 to (# ref waveforms) in NR1 format

The :WMEemory<r>:CLEar command clears the specified reference waveform location.

- See Also**
- [Chapter 36](#), “:WMEemory<r> Commands,” starting on page 1273
 - [":WMEemory<r>:SAVE"](#) on page 1278
 - [":WMEemory<r>:DISPlay"](#) on page 1276

:WMEemory<r>:DISPlay

N (see [page 1384](#))

Command Syntax :WMEemory<r>:DISPlay <on_off>

<r> ::= 1 to (# ref waveforms) in NR1 format

<on_off> ::= {{1 | ON} | {0 | OFF}}

The :WMEemory<r>:DISPlay command turns the display of the specified reference waveform on or off.

There are two reference waveform locations, but only one reference waveform can be displayed at a time. That means, if :WMEemory1:DISPlay is ON, sending the :WMEemory2:DISPlay ON command will automatically set :WMEemory1:DISPlay OFF.

Query Syntax :WMEemory<r>:DISPlay?

The :WMEemory<r>:DISPlay? query returns the current display setting for the reference waveform.

Return Format <on_off><NL>

<on_off> ::= {1 | 0}

- See Also**
- [Chapter 36](#), “:WMEemory<r> Commands,” starting on page 1273
 - [":WMEemory<r>:CLEar"](#) on page 1275
 - [":WMEemory<r>:LABel"](#) on page 1277

:WMEemory<r>:LABel

N (see [page 1384](#))

Command Syntax :WMEemory<r>:LABel <string>
 <r> ::= 1 to (# ref waveforms) in NR1 format
 <string> ::= quoted ASCII string

NOTE

Label strings are 10 characters or less, and may contain any commonly used ASCII characters. Labels with more than 10 characters are truncated to 10 characters. Lower case characters are converted to upper case.

The :WMEemory<r>:LABel command sets the reference waveform label to the string that follows.

Setting a label for a reference waveform also adds the name to the label list in non-volatile memory (replacing the oldest label in the list).

Query Syntax :WMEemory<r>:LABel?

The :WMEemory<r>:LABel? query returns the label associated with a particular reference waveform.

Return Format <string><NL>
 <string> ::= quoted ASCII string

- See Also**
- [Chapter 36](#), “:WMEemory<r> Commands,” starting on page 1273
 - [":WMEemory<r>:DISPlay"](#) on page 1276

:WMEemory<r>:SAVE

N (see [page 1384](#))

Command Syntax :WMEemory<r>:SAVE <source>

<r> ::= 1 to (# ref waveforms) in NR1 format

<source> ::= {CHANnel<n> | FUNction<m> | MATH<m>}

<n> ::= 1 to (# analog channels) in NR1 format

<m> ::= 1 to (# math functions) in NR1 format

The :WMEemory<r>:SAVE command copies the analog channel or math function waveform to the specified reference waveform location.

NOTE

Math functions whose x-axis is not frequency can be saved as reference waveforms.

-
- See Also**
- [Chapter 36](#), “:WMEemory<r> Commands,” starting on page 1273
 - “:WMEemory<r>:DISPlay” on page 1276

:WMEemory<r>:SKEW

N (see [page 1384](#))

Command Syntax :WMEemory<r>:SKEW <skew>

<r> ::= 1 to (# ref waveforms) in NR1 format

<skew> ::= time in seconds in NR3 format

The :WMEemory<r>:SKEW command sets the skew factor for the specified reference waveform.

Query Syntax :WMEemory<r>:SKEW?

The :WMEemory<r>:SKEW? query returns the current skew setting for the selected reference waveform.

Return Format <skew><NL>

<skew> ::= time in seconds in NR3 format

- See Also**
- [Chapter 36](#), “:WMEemory<r> Commands,” starting on page 1273
 - [":WMEemory<r>:DISPlay"](#) on page 1276
 - [":WMEemory<r>:YOFFset"](#) on page 1280
 - [":WMEemory<r>:YRANge"](#) on page 1281
 - [":WMEemory<r>:YSCale"](#) on page 1282

:WMEemory<r>:YOFFset

N (see [page 1384](#))

Command Syntax :WMEemory<r>:YOFFset <offset> [<suffix>]

<r> ::= 1 to (# ref waveforms) in NR1 format

<offset> ::= vertical offset value in NR3 format

<suffix> ::= {V | mV}

The :WMEemory<r>:YOFFset command sets the value that is represented at center screen for the selected reference waveform.

The range of legal values varies with the value set by the :WMEemory<r>:YRANge or :WMEemory<r>:YSCale commands. If you set the offset to a value outside of the legal range, the offset value is automatically set to the nearest legal value. Legal values are affected by the probe attenuation setting.

Query Syntax :WMEemory<r>:YOFFset?

The :WMEemory<r>:YOFFset? query returns the current offset value for the selected reference waveform.

Return Format <offset><NL>

<offset> ::= vertical offset value in NR3 format

- See Also**
- [Chapter 36](#), “:WMEemory<r> Commands,” starting on page 1273
 - [":WMEemory<r>:DISPlay"](#) on page 1276
 - [":WMEemory<r>:YRANge"](#) on page 1281
 - [":WMEemory<r>:YSCale"](#) on page 1282
 - [":WMEemory<r>:SKEW"](#) on page 1279

:WMEemory<r>:YRANge

N (see [page 1384](#))

Command Syntax :WMEemory<r>:YRANge <range>[<suffix>]

<r> ::= 1 to (# ref waveforms) in NR1 format

<range> ::= vertical full-scale range value in NR3 format

<suffix> ::= {V | mV}

The :WMEemory<r>:YRANge command defines the full-scale vertical axis of the selected reference waveform.

Legal values for the range are copied from the original source waveform (that is, the analog channel or math function waveform that was originally saved as a reference waveform).

Query Syntax :WMEemory<r>:YRANge?

The :WMEemory<r>:YRANge? query returns the current full-scale range setting for the specified reference waveform.

Return Format <range><NL>

<range> ::= vertical full-scale range value in NR3 format

- See Also**
- [Chapter 36](#), “:WMEemory<r> Commands,” starting on page 1273
 - [":WMEemory<r>:DISPlay"](#) on page 1276
 - [":WMEemory<r>:YOFFset"](#) on page 1280
 - [":WMEemory<r>:SKEW"](#) on page 1279
 - [":WMEemory<r>:YSCale"](#) on page 1282

:WMEemory<r>:YScale

N (see [page 1384](#))

Command Syntax :WMEemory<r>:YScale <scale>[<suffix>]

<r> ::= 1 to (# ref waveforms) in NR1 format

<scale> ::= vertical units per division in NR3 format

<suffix> ::= {V | mV}

The :WMEemory<r>:YScale command sets the vertical scale, or units per division, of the selected reference waveform.

Legal values for the scale are copied from the original source waveform (that is, the analog channel or math function waveform that was originally saved as a reference waveform).

Query Syntax :WMEemory<r>:YScale?

The :WMEemory<r>:YScale? query returns the current scale setting for the specified reference waveform.

Return Format <scale><NL>

<scale> ::= vertical units per division in NR3 format

- See Also**
- [Chapter 36](#), “:WMEemory<r> Commands,” starting on page 1273
 - [":WMEemory<r>:DISPlay"](#) on page 1276
 - [":WMEemory<r>:YOFFset"](#) on page 1280
 - [":WMEemory<r>:YRANge"](#) on page 1281
 - [":WMEemory<r>:SKEW"](#) on page 1279

37 Obsolete and Discontinued Commands

Obsolete commands are older forms of commands that are provided to reduce customer rework for existing systems and programs (see "**Obsolete Commands**" on page 1384).

Obsolete Command	Current Command Equivalent	Behavior Differences
ANALog<n>:BWLimit	:CHANnel<n>:BWLimit (see page 292)	
ANALog<n>:COUPling	:CHANnel<n>:COUPling (see page 293)	
ANALog<n>:INVert	:CHANnel<n>:INVert (see page 296)	
ANALog<n>:LABel	:CHANnel<n>:LABel (see page 297)	
ANALog<n>:OFFSet	:CHANnel<n>:OFFSet (see page 298)	
ANALog<n>:PROBe	:CHANnel<n>:PROBe (see page 299)	
ANALog<n>:PMODE	none	
ANALog<n>:RANGe	:CHANnel<n>:RANGe (see page 308)	
:CHANnel:ACTivity (see page 1290)	:ACTivity (see page 217)	
:CHANnel:LABel (see page 1291)	:CHANnel<n>:LABel (see page 297) or :DIGital<n>:LABel (see page 336)	use CHANnel<n>:LABel for analog channels and use DIGital<n>:LABel for digital channels

Obsolete Command	Current Command Equivalent	Behavior Differences
:CHANnel:THReshold (see page 1292)	:POD<n>:THReshold (see page 619) or :DIGital<d>:THReshold (see page 339)	
:CHANnel2:SKEW (see page 1293)	:CHANnel<n>:PROBe:SKEW (see page 304)	
:CHANnel<n>:INPut (see page 1294)	:CHANnel<n>:IMPedance (see page 295)	
:CHANnel<n>:PMODE (see page 1295)	none	
:DISPlay:CONNect (see page 1296)	:DISPlay:VECTors (see page 358)	
:DISPlay:ORDer (see page 1297)	none	
:ERASe (see page 1298)	:DISPlay:CLEar (see page 350)	
:EXTernal:PMODE (see page 1299)	none	
FUNCTION1, FUNCTION2	:FUNCTION Commands (see page 391)	ADD not included
:FUNCTION Commands	:FUNCTION2 Commands (see page 391)	:FUNCTION commands (with no <m> number) map to :FUNCTION2. This allows legacy programs to work without change.
:FUNCTION:GOFT:OPERation (see page 1300)	:FUNCTION1:OPERation (see page 418)	GOFT maps to FUNCTION1.
:FUNCTION:GOFT:SOURce1 (see page 1301)	:FUNCTION1:SOURce1 (see page 426)	GOFT maps to FUNCTION1.
:FUNCTION:GOFT:SOURce2 (see page 1302)	:FUNCTION1:SOURce2 (see page 428)	GOFT maps to FUNCTION1.
:FUNCTION:SOURce (see page 1303)	:FUNCTION:SOURce1 (see page 426)	Obsolete command has ADD, SUBTract, and MULTiPLY parameters; current command has GOFT parameter.
:FUNCTION:VIEW (see page 1304)	:FUNCTION:DISPlay (see page 403)	
:HARDcopy:DESTination (see page 1305)	:HARDcopy:FILEname (see page 1306)	

Obsolete Command	Current Command Equivalent	Behavior Differences
:HARDcopy:FILENAME (see page 1306)	:RECall:FILENAME (see page 719) :SAVE:FILENAME (see page 719)	
:HARDcopy:GRAYscale (see page 1307)	:HARDcopy:PALette (see page 445)	
:HARDcopy:IGColors (see page 1308)	:HARDcopy:INKSaver (see page 437)	
:HARDcopy:PDRiver (see page 1309)	:HARDcopy:APRinter (see page 434)	
:MEASure:LOWer (see page 1310)	:MEASure:DEFine:THResholds (see page 499)	MEASure:DEFine:THResholds can define absolute values or percentage
:MEASure:SCRatch (see page 1311)	:MEASure:CLEar (see page 496)	
:MEASure:TDELta (see page 1312)	:MARKer:XDELta (see page 464)	
:MEASure:THResholds (see page 1313)	:MEASure:DEFine:THResholds (see page 499)	MEASure:DEFine:THResholds can define absolute values or percentage
:MEASure:TMAX (see page 1314)	:MEASure:XMAX (see page 554)	
:MEASure:TMIN (see page 1315)	:MEASure:XMIN (see page 555)	
:MEASure:TSTArt (see page 1316)	:MARKer:X1Position (see page 459)	
:MEASure:TSTOp (see page 1317)	:MARKer:X2Position (see page 462)	
:MEASure:TVOlt (see page 1318)	:MEASure:TVALue (see page 541)	TVALue measures additional values such as db, Vs, etc.
:MEASure:UPPer (see page 1319)	:MEASure:DEFine:THResholds (see page 499)	MEASure:DEFine:THResholds can define absolute values or percentage
:MEASure:VDELta (see page 1320)	:MARKer:YDELta (see page 471)	
:MEASure:VSTArt (see page 1321)	:MARKer:Y1Position (see page 468)	
:MEASure:VSTOp (see page 1322)	:MARKer:Y2Position (see page 470)	

Obsolete Command	Current Command Equivalent	Behavior Differences
:MTESt:AMASK:{SAVE STORe} (see page 1323)	:SAVE:MASK[:START] (see page 737)	
:MTESt:AVERAge (see page 1324)	:ACQuire:TYPE AVERAge (see page 265)	
:MTESt:AVERAge:COUNT (see page 1325)	:ACQuire:COUNT (see page 256)	
:MTESt:LOAD (see page 1326)	:RECall:MASK[:START] (see page 721)	
:MTESt:RUMode (see page 1327)	:MTESt:RMODE (see page 600)	
:MTESt:RUMode:SOFailure (see page 1328)	:MTESt:RMODE:FACTion:STOP (see page 604)	
:MTESt:{START STOP} (see page 1329)	:RUN (see page 246) or :STOP (see page 250)	
:MTESt:TRIGger:SOURce (see page 1330)	:TRIGger Commands (see page 1097)	There are various commands for setting the source with different types of triggers.
:PRINT? (see page 1331)	:DISPlay:DATA? (see page 351)	
:SAVE:IMAGe:AREA (see page 1333)	none	
:TIMEbase:DELAy (see page 1337)	:TIMEbase:POSition (see page 1088) or :TIMEbase:WINDow:POSition (see page 1094)	TIMEbase:POSition is position value of main time base; TIMEbase:WINDow:POSition is position value of zoomed (delayed) time base window.
:SBUS<n>:LIN:SIGNal:DEFinitio n (see page 1334)	none	
:SBUS<n>:SPI:SOURce:DATA (see page 1335)	:SBUS<n>:SPI:SOURce:MOSI (see page 939)	
:SYSTem:MENU (see page 1336)	:DISPlay:MENU (see page 355)	No change in behavior.
:TRIGger:THReshold (see page 1338)	:POD<n>:THReshold (see page 619) or :DIGital<d>:THReshold (see page 339)	
:TRIGger:TV:TVMode (see page 1339)	:TRIGger:TV:MODE (see page 1174)	

Discontinued Commands Discontinued commands are commands that were used by previous oscilloscopes, but are not supported by the InfiniiVision 3000T X-Series oscilloscopes. Listed below are the Discontinued commands and the nearest equivalent command available (if any).

Discontinued Command	Current Command Equivalent	Comments
ASTore	:DISPlay:PERsistence INFinite (see page 357)	
CHANnel:MATH	:FUNction:OPERation (see page 418)	ADD not included
CHANnel<n>:PROtect	:CHANnel<n>:PROtection (see page 307)	Previous form of this command was used to enable/disable 50Ω protection. The new command resets a tripped protect and the query returns the status of TRIPed or NORMal.
DISPlay:INVerse	none	
DISPlay:COLumn	none	
DISPlay:FREeze	none	
DISPlay:GRID	none	
DISPLay:LINE	none	
DISPlay:PIXel	none	
DISPlay:POSition	none	
DISPlay:ROW	none	
DISPlay:TEXT	none	
FUNction:MOVE	none	
FUNction:PEAKs	none	
HARDcopy:ADDRes	none	Only parallel printer port is supported. GPIB printing not supported
MASK	none	All commands discontinued, feature not available
:POWer:SIGNals:CYCLes	:POWer:SIGNals:CYCLes:HARMonics (see page 684) :POWer:SIGNals:CYCLes:QUALity (see page 685)	This command was separated into several other commands for specific types of power analysis.

Discontinued Command	Current Command Equivalent	Comments
:POWer:SIGNals:DURation	:POWer:SIGNals:DURation:EFFiciency (see page 686) :POWer:SIGNals:DURation:MODulation (see page 687) :POWer:SIGNals:DURation:ONOff:OFF (see page 688) :POWer:SIGNals:DURation:ONOff:ON (see page 689) :POWer:SIGNals:DURation:RIPl (see page 690) :POWer:SIGNals:DURation:TRANsient (see page 691)	This command was separated into several other commands for specific types of power analysis.
:POWer:SIGNals:VMAXimum	:POWer:SIGNals:VMAXimum:INRush (see page 694) :POWer:SIGNals:VMAXimum:ONOff:OFF (see page 695) :POWer:SIGNals:VMAXimum:ONOff:ON (see page 696)	This command was separated into several other commands for specific types of power analysis.
:POWer:SIGNals:VSTeady	:POWer:SIGNals:VSTeady:ONOff:OFF (see page 697) :POWer:SIGNals:VSTeady:ONOff:ON (see page 698) :POWer:SIGNals:VSTeady:TRANsient (see page 699)	This command was separated into several other commands for specific types of power analysis.
:POWer:SLEW:VALue	none	Slew rate values are now displayed using max and min measurements of a differentiate math function signal.
:PWRenable	none	The Power Event Enable Register does not exist in the 3000T X-Series oscilloscopes.
:PWRRegister[:EVENT]	none	The Power Event Event Register does not exist in the 3000T X-Series oscilloscopes.
SYSTem:KEY	none	
TEST:ALL	*TST (Self Test) (see page 211)	
TRACE subsystem	none	All commands discontinued, feature not available
TRIGger:ADVanced subsystem		Use new GLITCh, PATtern, or TV trigger modes

Discontinued Command	Current Command Equivalent	Comments
TRIGger:TV:FIELD	:TRIGger:TV:MODE (see page 1174)	
TRIGger:TV:TVHFrej		
TRIGger:TV:VIR	none	
:TRIGger:USB:SOURce:DMINus	none	USB serial decode and triggering is not supported on the 3000T X-Series oscilloscopes.
:TRIGger:USB:SOURce:DPLus	none	
:TRIGger:USB:SPEed	none	
:TRIGger:USB:TRIGger	none	
VAUToscale	none	

Discontinued Parameters

Some previous oscilloscope queries returned control setting values of OFF and ON. The InfiniiVision 3000T X-Series oscilloscopes only return the enumerated values 0 (for off) and 1 (for on).

:CHANnel:ACTivity

0 (see [page 1384](#))

Command Syntax :CHANnel:ACTivity

The :CHANnel:ACTivity command clears the cumulative edge variables for the next activity query.

NOTE

The :CHANnel:ACTivity command is an obsolete command provided for compatibility to previous oscilloscopes. Use the :ACTivity command (see [page 217](#)) instead.

Query Syntax :CHANnel:ACTivity?

The :CHANnel:ACTivity? query returns the active edges since the last clear, and returns the current logic levels.

Return Format <edges>, <levels><NL>

<edges> ::= presence of edges (32-bit integer in NR1 format).

<levels> ::= logical highs or lows (32-bit integer in NR1 format).

NOTE

A bit equal to zero indicates that no edges were detected at the specified threshold since the last clear on that channel. Edges may have occurred that were not detected because of the threshold setting.

A bit equal to one indicates that edges have been detected at the specified threshold since the last clear on that channel.

:CHANnel:LABel

O (see [page 1384](#))

Command Syntax :CHANnel:LABel <source_text><string>
 <source_text> ::= {CHANnel1 | CHANnel2 | DIGital<d>}
 <d> ::= 0 to (# digital channels - 1) in NR1 format
 <string> ::= quoted ASCII string

The :CHANnel:LABel command sets the source text to the string that follows. Setting a channel will also result in the name being added to the label list.

NOTE

The :CHANnel:LABel command is an obsolete command provided for compatibility to previous oscilloscopes. Use the :CHANnel<n>:LABel command (see [page 297](#)) or :DIGital<n>:LABel command (see [page 336](#)).

Query Syntax :CHANnel:LABel?

The :CHANnel:LABel? query returns the label associated with a particular analog channel.

Return Format <string><NL>
 <string> ::= quoted ASCII string

:CHANnel:THReshold

O (see [page 1384](#))

Command Syntax :CHANnel:THReshold <channel group>, <threshold type> [, <value>]
 <channel group> ::= {POD1 | POD2}
 <threshold type> ::= {CMOS | ECL | TTL | USERdef}
 <value> ::= voltage for USERdef in NR3 format [volt_type]
 [volt_type] ::= {V | mV (-3) | uV (-6)}

The :CHANnel:THReshold command sets the threshold for a group of channels. The threshold is either set to a predefined value or to a user-defined value. For the predefined value, the voltage parameter is ignored.

NOTE

The :CHANnel:THReshold command is an obsolete command provided for compatibility to previous oscilloscopes. Use the :POD<n>:THReshold command (see [page 619](#)) or :DIGital<n>:THReshold command (see [page 339](#)).

Query Syntax :CHANnel:THReshold? <channel group>

The :CHANnel:THReshold? query returns the voltage and threshold text for a specific group of channels.

Return Format <threshold type> [, <value>]<NL>
 <threshold type> ::= {CMOS | ECL | TTL | USERdef}
 <value> ::= voltage for USERdef (float 32 NR3)

NOTE

- CMOS = 2.5V
- TTL = 1.5V
- ECL = -1.3V
- USERdef ::= -6.0V to 6.0V

:CHANnel2:SKEW

O (see [page 1384](#))

Command Syntax :CHANnel2:SKEW <skew value>
 <skew value> ::= skew time in NR3 format
 <skew value> ::= -100 ns to +100 ns

The :CHANnel2:SKEW command sets the skew between channels 1 and 2. The maximum skew is +/-100 ns. You can use the oscilloscope's analog probe skew control to remove cable delay errors between channel 1 and channel 2.

NOTE

The :CHANnel2:SKEW command is an obsolete command provided for compatibility to previous oscilloscopes. Use the :CHANnel<n>:PROBe:SKEW command (see [page 304](#)) instead.

NOTE

This command is only valid for the two channel oscilloscope models.

Query Syntax :CHANnel2:SKEW?

The :CHANnel2:SKEW? query returns the current probe skew setting for the selected channel.

Return Format <skew value><NL>
 <skew value> ::= skew value in NR3 format

See Also • ["Introduction to :CHANnel<n> Commands"](#) on page 291

`:CHANnel<n>:INPut`

O (see [page 1384](#))

Command Syntax `:CHANnel<n>:INPut <impedance>`
`<impedance> ::= {ONEMeg | FIFTy}`
`<n> ::= 1 to (# analog channels) in NR1 format`

The `:CHANnel<n>:INPut` command selects the input impedance setting for the specified channel. The legal values for this command are ONEMeg (1 M Ω) and FIFTy (50 Ω).

NOTE

The `:CHANnel<n>:INPut` command is an obsolete command provided for compatibility to previous oscilloscopes. Use the `:CHANnel<n>:IMPedance` command (see [page 295](#)) instead.

Query Syntax `:CHANnel<n>:INPut?`

The `:CHANnel<n>:INPut?` query returns the current input impedance setting for the specified channel.

Return Format `<impedance value><NL>`
`<impedance value> ::= {ONEM | FIFT}`

:CHANnel<n>:PMODE

O (see [page 1384](#))

Command Syntax :CHANnel<n>:PMODE <pmode value>
 <pmode value> ::= {AUTO | MANual}
 <n> ::= 1 to (# analog channels) in NR1 format

The probe sense mode is controlled internally and cannot be set. If a probe with sense is connected to the specified channel, auto sensing is enabled; otherwise, the mode is manual.

If the PMODE sent matches the oscilloscope's setting, the command will be accepted. Otherwise, a setting conflict error is generated.

NOTE

The :CHANnel<n>:PMODE command is an obsolete command provided for compatibility to previous oscilloscopes.

Query Syntax :CHANnel<n>:PMODE?

The :CHANnel<n>:PMODE? query returns AUT if an autosense probe is attached and MAN otherwise.

Return Format <pmode value><NL>
 <pmode value> ::= {AUT | MAN}

:DISPlay:CONNect

O (see [page 1384](#))

Command Syntax `:DISPlay:CONNect <connect>`
 `<connect> ::= {{ 1 | ON} | {0 | OFF}}`

The `:DISPlay:CONNect` command turns vectors on and off. When vectors are turned on, the oscilloscope displays lines connecting sampled data points. When vectors are turned off, only the sampled data is displayed.

NOTE

The `:DISPlay:CONNect` command is an obsolete command provided for compatibility to previous oscilloscopes. Use the `:DISPlay:VECTors` command (see [page 358](#)) instead.

Query Syntax `:DISPlay:CONNect?`

The `:DISPlay:CONNect?` query returns the current state of the vectors setting.

Return Format `<connect><NL>`
 `<connect> ::= {1 | 0}`

See Also • [":DISPlay:VECTors"](#) on page 358

:DISPlay:ORDer

O (see [page 1384](#))

Query Syntax :DISPlay:ORDer?

The :DISPlay:ORDer? query returns a list of digital channel numbers in screen order, from top to bottom, separated by commas. Busing is displayed as digital channels with no separator. For example, in the following list, the bus consists of digital channels 4 and 5: DIG1, DIG4 DIG5, DIG7.

NOTE

The :DISPlay:ORDer command is an obsolete command provided for compatibility to previous oscilloscopes. This command is only available on the MSO models.

Return Format <order><NL>
 <order> ::= Unquoted ASCII string

NOTE

A return value is included for each digital channel. A return value of NONE indicates that a channel is turned off.

See Also • [":DIGital<d>:POSition"](#) on page 337

Example Code

```
' DISP_ORDER - Set the order the channels are displayed on the
' analyzer. You can enter between 1 and 32 channels at one time.
' If you leave out channels, they will not be displayed.

' Display ONLY channel 0 and channel 10 in that order.
myScope.WriteString ":DISPLAY:ORDER 0,10"
```

See complete example programs at: [Chapter 42](#), "Programming Examples," starting on page 1393

:ERASe

O (see [page 1384](#))

Command Syntax :ERASe

The :ERASe command erases the screen.

NOTE

The :ERASe command is an obsolete command provided for compatibility to previous oscilloscopes. Use the :DISplay:CLEar command (see [page 350](#)) instead.

`:EXtErnal:PMODE`

O (see [page 1384](#))

Command Syntax `:EXtErnal:PMODE <pmode value>`
`<pmode value> ::= {AUTo | MANual}`

The probe sense mode is controlled internally and cannot be set. If a probe with sense is connected to the specified channel, auto sensing is enabled; otherwise, the mode is manual.

If the pmode sent matches the oscilloscope's setting, the command will be accepted. Otherwise, a setting conflict error is generated.

NOTE

The `:EXtErnal:PMODE` command is an obsolete command provided for compatibility to previous oscilloscopes.

Query Syntax `:EXtErnal:PMODE?`

The `:EXtErnal:PMODE?` query returns AUT if an autosense probe is attached and MAN otherwise.

Return Format `<pmode value><NL>`
`<pmode value> ::= {AUT | MAN}`

:FUNCTION:GOFT:OPERation

O (see [page 1384](#))

Command Syntax :FUNCTION:GOFT:OPERation <operation>

<operation> ::= {ADD | SUBTract | MULTiPLY}

The :FUNCTION:GOFT:OPERation command sets the math operation for the g(t) source that can be used as the input to transform or filter functions (if available):

- ADD – Source1 + source2.
- SUBTract – Source1 - source2.
- MULTiPLY – Source1 * source2.

The :FUNCTION:GOFT:SOURce1 and :FUNCTION:GOFT:SOURce2 commands are used to select source1 and source2.

:FUNction:GOFT:SOURce1

O (see [page 1384](#))

Command Syntax :FUNction:GOFT:SOURce1 <value>

<value> ::= CHANnel<n>

<n> ::= {1 | 2 | 3 | 4} for 4ch models

<n> ::= {1 | 2} for 2ch models

The :FUNction:GOFT:SOURce1 command selects the first input channel for the g(t) source that can be used as the input to transform or filter functions (if available).

Query Syntax :FUNction:GOFT:SOURce1?

The :FUNction:GOFT:SOURce1? query returns the current selection for the first input channel for the g(t) source.

Return Format <value><NL>

<value> ::= CHAN<n>

<n> ::= {1 | 2 | 3 | 4} for the 4ch models

<n> ::= {1 | 2} for the 2ch models

- See Also**
- ["Introduction to :FUNction<m> Commands"](#) on page 395
 - [":FUNction:GOFT:SOURce2"](#) on page 1302
 - [":FUNction:GOFT:OPERation"](#) on page 1300

:FUNCTION:GOFT:SOURce2

O (see [page 1384](#))

Command Syntax :FUNCTION:GOFT:SOURce2 <value>
 <value> ::= CHANnel<n>
 <n> ::= {1 | 2 | 3 | 4} for 4ch models
 <n> ::= {1 | 2} for 2ch models

The :FUNCTION:GOFT:SOURce2 command selects the second input channel for the g(t) source that can be used as the input to transform or filter functions (if available).

Query Syntax :FUNCTION:GOFT:SOURce2?

The :FUNCTION:GOFT:SOURce2? query returns the current selection for the second input channel for the g(t) source.

Return Format <value><NL>
 <value> ::= CHAN<n>
 <n> ::= {1 | 2 | 3 | 4} for 4ch models
 <n> ::= {1 | 2} for 2ch models

- See Also**
- ["Introduction to :FUNCTION<m> Commands"](#) on page 395
 - [":FUNCTION:GOFT:SOURce1"](#) on page 1301
 - [":FUNCTION:GOFT:OPERation"](#) on page 1300

:FUNCTION:SOURce

O (see [page 1384](#))

Command Syntax :FUNCTION:SOURce <value>
 <value> ::= {CHANnel<n> | ADD | SUBTract | MULTiply}
 <n> ::= 1 to (# analog channels) in NR1 format

The :FUNCTION:SOURce command is only used when an FFT (Fast Fourier Transform), DIFF, or INT operation is selected (see the:FUNCTION:OPERation command for more information about selecting an operation). The :FUNCTION:SOURce command selects the source for function operations. Choose CHANnel<n>, or ADD, SUBT, or MULT to specify the desired source for function DIFF (differentiate), INTegrate, and FFT operations specified by the :FUNCTION:OPERation command.

NOTE

The :FUNCTION:SOURce command is an obsolete command provided for compatibility to previous oscilloscopes. Use the :FUNCTION:SOURce1 command (see [page 426](#)) instead.

Query Syntax :FUNCTION:SOURce?

The :FUNCTION:SOURce? query returns the current source for function operations.

Return Format <value><NL>
 <value> ::= {CHAN<n> | ADD | SUBT | MULT}
 <n> ::= 1 to (# analog channels) in NR1 format

- See Also**
- ["Introduction to :FUNCTION<m> Commands"](#) on page 395
 - [":FUNCTION<m>:OPERation"](#) on page 418

:FUNCTION:VIEW

O (see [page 1384](#))

Command Syntax :FUNCTION:VIEW <view>
 <view> ::= {{1 | ON} | (0 | OFF}}

The :FUNCTION:VIEW command turns the selected function on or off. When ON is selected, the function performs as specified using the other FUNCTION commands. When OFF is selected, function is neither calculated nor displayed.

NOTE

The :FUNCTION:VIEW command is provided for backward compatibility to previous oscilloscopes. Use the :FUNCTION:DISPLAY command (see [page 403](#)) instead.

Query Syntax :FUNCTION:VIEW?

The :FUNCTION:VIEW? query returns the current state of the selected function.

Return Format <view><NL>
 <view> ::= {1 | 0}

:HARDcopy:DESTination

O (see [page 1384](#))

Command Syntax :HARDcopy:DESTination <destination>
<destination> ::= {CENTronics | FLOppy}

The :HARDcopy:DESTination command sets the hardcopy destination.

NOTE

The :HARDcopy:DESTination command is an obsolete command provided for compatibility to previous oscilloscopes. Use the :HARDcopy:FILENAME command (see [page 1306](#)) instead.

Query Syntax :HARDcopy:DESTination?

The :HARDcopy:DESTination? query returns the selected hardcopy destination.

Return Format <destination><NL>
<destination> ::= {CENT | FLOP}

See Also • ["Introduction to :HARDcopy Commands"](#) on page 432

:HARDcopy:FILENAME

O (see [page 1384](#))

Command Syntax :HARDcopy:FILENAME <string>
<string> ::= quoted ASCII string

The HARDcopy:FILENAME command sets the output filename for those print formats whose output is a file.

NOTE

The :HARDcopy:FILENAME command is an obsolete command provided for compatibility to previous oscilloscopes. Use the :SAVE:FILENAME command (see [page 730](#)) and :RECall:FILENAME command (see [page 719](#)) instead.

Query Syntax :HARDcopy:FILENAME?

The :HARDcopy:FILENAME? query returns the current hardcopy output filename.

Return Format <string><NL>
<string> ::= quoted ASCII string

See Also • ["Introduction to :HARDcopy Commands"](#) on page 432

:HARDcopy:GRAYscale

O (see [page 1384](#))

Command Syntax :HARDcopy:GRAYscale <gray>
<gray> ::= {{OFF | 0} | {ON | 1}}

The :HARDcopy:GRAYscale command controls whether grayscaling is performed in the hardcopy dump.

NOTE

The :HARDcopy:GRAYscale command is an obsolete command provided for compatibility to previous oscilloscopes. Use the :HARDcopy:PALETTE command (see [page 445](#)) instead. (":HARDcopy:GRAYscale ON" is the same as ":HARDcopy:PALETTE GRAYscale" and ":HARDcopy:GRAYscale OFF" is the same as ":HARDcopy:PALETTE COLor".)

Query Syntax :HARDcopy:GRAYscale?

The :HARDcopy:GRAYscale? query returns a flag indicating whether grayscaling is performed in the hardcopy dump.

Return Format <gray><NL>
<gray> ::= {0 | 1}

See Also • ["Introduction to :HARDcopy Commands"](#) on page 432

:HARDcopy:IGColors

O (see [page 1384](#))

Command Syntax :HARDcopy:IGColors <value>
<value> ::= {{OFF | 0} | {ON | 1}}

The HARDcopy:IGColors command controls whether the graticule colors are inverted or not.

NOTE

The :HARDcopy:IGColors command is an obsolete command provided for compatibility to previous oscilloscopes. Use the :HARDcopy:INKSaver (see [page 437](#)) command instead.

Query Syntax :HARDcopy:IGColors?

The :HARDcopy:IGColors? query returns a flag indicating whether graticule colors are inverted or not.

Return Format <value><NL>
<value> ::= {0 | 1}

See Also • ["Introduction to :HARDcopy Commands"](#) on page 432

:HARDcopy:PDRiver

O (see [page 1384](#))

Command Syntax :HARDcopy:PDRiver <driver>

```
<driver> ::= {AP2Xxx | AP21xx | {AP2560 | AP25} | {DJ350 | DJ35} |
             DJ6xx | {DJ630 | DJ63} | DJ6Special | DJ6Photo |
             DJ8Special | DJ8xx | DJ9Vip | OJPRokx50 | DJ9xx | GVIP |
             DJ55xx | {PS470 | PS47} {PS100 | PS10} | CLASer |
             MLASer | LjFastraster | POSTscript}
```

The HARDcopy:PDRiver command sets the hardcopy printer driver used for the selected printer.

If the correct driver for the selected printer can be identified, it will be selected and cannot be changed.

NOTE

The :HARDcopy:PDRiver command is an obsolete command provided for compatibility to previous oscilloscopes. Use the :HARDcopy:APRinter (see [page 434](#)) command instead.

Query Syntax :HARDcopy:PDRiver?

The :HARDcopy:PDRiver? query returns the selected hardcopy printer driver.

Return Format <driver><NL>

```
<driver> ::= {AP2X | AP21 | AP25 | DJ35 | DJ6 | DJ63 | DJ6S | DJ6P |
             DJ8S | DJ8 | DJ9V | OJPR | DJ9 | GVIP | DJ55 | PS10 |
             PS47 | CLAS | MLAS | LjF | POST}
```

See Also • ["Introduction to :HARDcopy Commands"](#) on page 432

:MEASure:LOWer

O (see [page 1384](#))

Command Syntax :MEASure:LOWer <voltage>

The :MEASure:LOWer command sets the lower measurement threshold value. This value and the UPPer value represent absolute values when the thresholds are ABSolute and percentage when the thresholds are PERCent as defined by the :MEASure:DEFine THResholds command.

NOTE

The :MEASure:LOWer command is obsolete and is provided for backward compatibility to previous oscilloscopes. Use the :MEASure:DEFine THResholds command (see [page 499](#)) instead.

Query Syntax :MEASure:LOWer?

The :MEASure:LOWer? query returns the current lower threshold level.

Return Format <voltage><NL>

<voltage> ::= the user-defined lower threshold in volts in NR3 format

- See Also**
- ["Introduction to :MEASure Commands"](#) on page 490
 - [":MEASure:THResholds"](#) on page 1313
 - [":MEASure:UPPer"](#) on page 1319

:MEASure:SCRatch

O (see [page 1384](#))

Command Syntax :MEASure:SCRatch

The :MEASure:SCRatch command clears all selected measurements and markers from the screen.

NOTE

The :MEASure:SCRatch command is obsolete and is provided for backward compatibility to previous oscilloscopes. Use the :MEASure:CLEar command (see [page 496](#)) instead.

:MEASure:TDELta

O (see [page 1384](#))

Query Syntax :MEASure:TDELta?

The :MEASure:TDELta? query returns the time difference between the Tstop marker (X2 cursor) and the Tstart marker (X1 cursor).

$T_{\text{delta}} = T_{\text{stop}} - T_{\text{start}}$

Tstart is the time at the start marker (X1 cursor) and Tstop is the time at the stop marker (X2 cursor). No measurement is made when the :MEASure:TDELta? query is received by the oscilloscope. The delta time value that is output is the current value. This is the same value as the front-panel cursors delta X value.

NOTE

The :MEASure:TDELta command is an obsolete command provided for compatibility to previous oscilloscopes. Use the :MARKer:XDELta command (see [page 464](#)) instead.

Return Format <value><NL>

<value> ::= time difference between start and stop markers in NR3 format

- See Also**
- ["Introduction to :MARKer Commands"](#) on page 455
 - ["Introduction to :MEASure Commands"](#) on page 490
 - [":MARKer:X1Position"](#) on page 459
 - [":MARKer:X2Position"](#) on page 462
 - [":MARKer:XDELta"](#) on page 464
 - [":MEASure:TSTArt"](#) on page 1316
 - [":MEASure:TSTOp"](#) on page 1317

:MEASure:THResholds

O (see [page 1384](#))

Command Syntax :MEASure:THResholds {T1090 | T2080 | VOLTage}

The :MEASure:THResholds command selects the thresholds used when making time measurements.

NOTE

The :MEASure:THResholds command is obsolete and is provided for backward compatibility to previous oscilloscopes. Use the :MEASure:DEFine THResholds command (see [page 499](#)) instead.

Query Syntax :MEASure:THResholds?

The :MEASure:THResholds? query returns the current thresholds selected when making time measurements.

Return Format {T1090 | T2080 | VOLTage}<NL>

{T1090} uses the 10% and 90% levels of the selected waveform.

{T2080} uses the 20% and 80% levels of the selected waveform.

{VOLTage} uses the upper and lower voltage thresholds set by the UPPer and LOWer commands on the selected waveform.

- See Also**
- "[Introduction to :MEASure Commands](#)" on page 490
 - "[:MEASure:LOWer](#)" on page 1310
 - "[:MEASure:UPPer](#)" on page 1319

:MEASure:TMAX

O (see [page 1384](#))

Command Syntax :MEASure:TMAX [<source>]

<source> ::= {CHANnel<n> | FUNction | MATH}

<n> ::= 1 to (# analog channels) in NR1 format

The :MEASure:TMAX command installs a screen measurement and starts an X-at-Max-Y measurement on the selected waveform. If the optional source is specified, the current source is modified.

NOTE

The :MEASure:TMAX command is obsolete and is provided for backward compatibility to previous oscilloscopes. Use the :MEASure:XMAX command (see [page 554](#)) instead.

Query Syntax :MEASure:TMAX? [<source>]

The :MEASure:TMAX? query returns the horizontal axis value at which the maximum vertical value occurs on the current source. If the optional source is specified, the current source is modified. If all channels are off, the query returns 9.9E+37.

Return Format <value><NL>

<value> ::= time at maximum in NR3 format

- See Also**
- ["Introduction to :MEASure Commands"](#) on page 490
 - [":MEASure:TMIN"](#) on page 1315
 - [":MEASure:XMAX"](#) on page 554
 - [":MEASure:XMIN"](#) on page 555

:MEASure:TMIN

O (see [page 1384](#))

Command Syntax :MEASure:TMIN [<source>]

<source> ::= {CHANnel<n> | FUNction | MATH}

<n> ::= 1 to (# analog channels) in NR1 format

The :MEASure:TMIN command installs a screen measurement and starts an X-at-Min-Y measurement on the selected waveform. If the optional source is specified, the current source is modified.

NOTE

The :MEASure:TMIN command is obsolete and is provided for backward compatibility to previous oscilloscopes. Use the :MEASure:XMIN command (see [page 555](#)) instead.

Query Syntax :MEASure:TMIN? [<source>]

The :MEASure:TMIN? query returns the horizontal axis value at which the minimum vertical value occurs on the current source. If the optional source is specified, the current source is modified. If all channels are off, the query returns 9.9E+37.

Return Format <value><NL>

<value> ::= time at minimum in NR3 format

- See Also**
- ["Introduction to :MEASure Commands"](#) on page 490
 - [":MEASure:TMAX"](#) on page 1314
 - [":MEASure:XMAX"](#) on page 554
 - [":MEASure:XMIN"](#) on page 555

:MEASure:TSTArt

O (see [page 1384](#))

Command Syntax :MEASure:TSTArt <value> [suffix]

<value> ::= time at the start marker in seconds

[suffix] ::= {s | ms | us | ns | ps}

The :MEASure:TSTArt command moves the start marker (X1 cursor) to the specified time with respect to the trigger time.

NOTE

The short form of this command, TSTA, does not follow the defined Long Form to Short Form Truncation Rules (see [page 1386](#)). The normal short form "TST" would be the same for both TSTArt and TSTOp, so sending TST for the TSTArt command produces an error.

NOTE

The :MEASure:TSTArt command is an obsolete command provided for compatibility to previous oscilloscopes. Use the :MARKer:X1Position command (see [page 459](#)) instead.

Query Syntax :MEASure:TSTArt?

The :MEASure:TSTArt? query returns the time at the start marker (X1 cursor).

Return Format <value><NL>

<value> ::= time at the start marker in NR3 format

- See Also**
- "[Introduction to :MARKer Commands](#)" on page 455
 - "[Introduction to :MEASure Commands](#)" on page 490
 - "[:MARKer:X1Position](#)" on page 459
 - "[:MARKer:X2Position](#)" on page 462
 - "[:MARKer:XDELta](#)" on page 464
 - "[:MEASure:TDELta](#)" on page 1312
 - "[:MEASure:TSTOp](#)" on page 1317

:MEASure:TSTOp

O (see [page 1384](#))

Command Syntax :MEASure:TSTOp <value> [suffix]
 <value> ::= time at the stop marker in seconds
 [suffix] ::= {s | ms | us | ns | ps}

The :MEASure:TSTOp command moves the stop marker (X2 cursor) to the specified time with respect to the trigger time.

NOTE

The short form of this command, TSTO, does not follow the defined Long Form to Short Form Truncation Rules (see [page 1386](#)). The normal short form "TST" would be the same for both TSTArt and TSTOp, so sending TST for the TSTOp command produces an error.

NOTE

The :MEASure:TSTOp command is an obsolete command provided for compatibility to previous oscilloscopes. Use the :MARKer:X2Position command (see [page 462](#)) instead.

Query Syntax :MEASure:TSTOp?

The :MEASure:TSTOp? query returns the time at the stop marker (X2 cursor).

Return Format <value><NL>

<value> ::= time at the stop marker in NR3 format

- See Also**
- ["Introduction to :MARKer Commands"](#) on page 455
 - ["Introduction to :MEASure Commands"](#) on page 490
 - [":MARKer:X1Position"](#) on page 459
 - [":MARKer:X2Position"](#) on page 462
 - [":MARKer:XDELta"](#) on page 464
 - [":MEASure:TDELta"](#) on page 1312
 - [":MEASure:TSTArt"](#) on page 1316

:MEASure:TVOLt

O (see [page 1384](#))

Query Syntax :MEASure:TVOLt? <value>, [<slope>]<occurrence>[,<source>]

<value> ::= the voltage level that the waveform must cross.

<slope> ::= direction of the waveform. A rising slope is indicated by a plus sign (+). A falling edge is indicated by a minus sign (-).

<occurrence> ::= the transition to be reported. If the occurrence number is one, the first crossing is reported. If the number is two, the second crossing is reported, etc.

<source> ::= {<digital channels> | CHANnel<n> | FUNction | MATH}

<digital channels> ::= {DIGital<d>} for the MSO models

<n> ::= 1 to (# analog channels) in NR1 format

<d> ::= 0 to (# digital channels - 1) in NR1 format

When the :MEASure:TVOLt? query is sent, the displayed signal is searched for the specified voltage level and transition. The time interval between the trigger event and this defined occurrence is returned as the response to the query.

The specified voltage can be negative or positive. To specify a negative voltage, use a minus sign (-). The sign of the slope selects a rising (+) or falling (-) edge. If no sign is specified for the slope, it is assumed to be the rising edge.

The magnitude of the occurrence defines the occurrence to be reported. For example, +3 returns the time for the third time the waveform crosses the specified voltage level in the positive direction. Once this voltage crossing is found, the oscilloscope reports the time at that crossing in seconds, with the trigger point (time zero) as the reference.

If the specified crossing cannot be found, the oscilloscope reports +9.9E+37. This value is returned if the waveform does not cross the specified voltage, or if the waveform does not cross the specified voltage for the specified number of times in the direction specified.

If the optional source parameter is specified, the current source is modified.

NOTE

The :MEASure:TVOLt command is obsolete and is provided for backward compatibility to previous oscilloscopes. Use the :MEASure:TVALue command (see [page 541](#)).

Return Format <value><NL>

<value> ::= time in seconds of the specified voltage crossing
in NR3 format

:MEASure:UPPer

O (see [page 1384](#))

Command Syntax :MEASure:UPPer <value>

The :MEASure:UPPer command sets the upper measurement threshold value. This value and the LOWer value represent absolute values when the thresholds are ABSolute and percentage when the thresholds are PERCent as defined by the :MEASure:DEFine THResholds command.

NOTE

The :MEASure:UPPer command is obsolete and is provided for backward compatibility to previous oscilloscopes. Use the :MEASure:DEFine THResholds command (see [page 499](#)) instead.

Query Syntax :MEASure:UPPer?

The :MEASure:UPPer? query returns the current upper threshold level.

Return Format <value><NL>

<value> ::= the user-defined upper threshold in NR3 format

- See Also**
- ["Introduction to :MEASure Commands"](#) on page 490
 - [":MEASure:LOWer"](#) on page 1310
 - [":MEASure:THResholds"](#) on page 1313

:MEASure:VDELta

O (see [page 1384](#))

Query Syntax :MEASure:VDELta?

The :MEASure:VDELta? query returns the voltage difference between vertical marker 1 (Y1 cursor) and vertical marker 2 (Y2 cursor). No measurement is made when the :MEASure:VDELta? query is received by the oscilloscope. The delta value that is returned is the current value. This is the same value as the front-panel cursors delta Y value.

VDELta = value at marker 2 - value at marker 1

NOTE

The :MEASure:VDELta command is an obsolete command provided for compatibility to previous oscilloscopes. Use the :MARKer:YDELta command (see [page 471](#)) instead.

Return Format <value><NL>

<value> ::= delta V value in NR1 format

- See Also**
- ["Introduction to :MARKer Commands"](#) on page 455
 - ["Introduction to :MEASure Commands"](#) on page 490
 - [":MARKer:Y1Position"](#) on page 468
 - [":MARKer:Y2Position"](#) on page 470
 - [":MARKer:YDELta"](#) on page 471
 - [":MEASure:TDELta"](#) on page 1312
 - [":MEASure:TSTArt"](#) on page 1316

:MEASure:VSTArt

O (see [page 1384](#))

Command Syntax :MEASure:VSTArt <vstart_argument>
 <vstart_argument> ::= value for vertical marker 1

The :MEASure:VSTArt command moves the vertical marker (Y1 cursor) to the specified value corresponding to the selected source. The source can be selected by the MARKer:X1Y1source command.

NOTE

The short form of this command, VSTA, does not follow the defined Long Form to Short Form Truncation Rules (see [page 1386](#)). The normal short form, VST, would be the same for both VSTArt and VSTOp, so sending VST for the VSTArt command produces an error.

NOTE

The :MEASure:VSTArt command is an obsolete command provided for compatibility to previous oscilloscopes. Use the :MARKer:Y1Position command (see [page 468](#)) instead.

Query Syntax :MEASure:VSTArt?

The :MEASure:VSTArt? query returns the current value of the Y1 cursor.

Return Format <value><NL>
 <value> ::= voltage at voltage marker 1 in NR3 format

- See Also**
- ["Introduction to :MARKer Commands"](#) on page 455
 - ["Introduction to :MEASure Commands"](#) on page 490
 - [":MARKer:Y1Position"](#) on page 468
 - [":MARKer:Y2Position"](#) on page 470
 - [":MARKer:YDELta"](#) on page 471
 - [":MARKer:X1Y1source"](#) on page 460
 - [":MEASure:SOURce"](#) on page 531
 - [":MEASure:TDELta"](#) on page 1312
 - [":MEASure:TSTArt"](#) on page 1316

:MEASure:VSTOp

O (see [page 1384](#))

Command Syntax :MEASure:VSTOp <vstop_argument>
<vstop_argument> ::= value for Y2 cursor

The :MEASure:VSTOp command moves the vertical marker 2 (Y2 cursor) to the specified value corresponding to the selected source. The source can be selected by the MARKer:X2Y2source command.

NOTE

The short form of this command, VSTO, does not follow the defined Long Form to Short Form Truncation Rules (see [page 1386](#)). The normal short form, VST, would be the same for both VSTArt and VSTOp, so sending VST for the VSTOp command produces an error.

NOTE

The :MEASure:VSTOp command is an obsolete command provided for compatibility to previous oscilloscopes. Use the :MARKer:Y2Position command (see [page 470](#)) instead.

Query Syntax :MEASure:VSTOp?

The :MEASure:VSTOp? query returns the current value of the Y2 cursor.

Return Format <value><NL>
<value> ::= value of the Y2 cursor in NR3 format

- See Also**
- "[Introduction to :MARKer Commands](#)" on page 455
 - "[Introduction to :MEASure Commands](#)" on page 490
 - "[:MARKer:Y1Position](#)" on page 468
 - "[:MARKer:Y2Position](#)" on page 470
 - "[:MARKer:YDELta](#)" on page 471
 - "[:MARKer:X2Y2source](#)" on page 463
 - "[:MEASure:SOURce](#)" on page 531
 - "[:MEASure:TDELta](#)" on page 1312
 - "[:MEASure:TSTArt](#)" on page 1316

:MTESt:AMASk:{SAVE | STORE}

O (see [page 1384](#))

Command Syntax :MTESt:AMASk:{SAVE | STORE} "<filename>"

The :MTESt:AMASk:SAVE command saves the automask generated mask to a file. If an automask has not been generated, an error occurs.

The <filename> parameter is an MS-DOS compatible name of the file, a maximum of 254 characters long (including the path name, if used). The filename assumes the present working directory if a path does not precede the file name.

NOTE

The :MTESt:AMASk:{SAVE | STORE} command is obsolete and is provided for backward compatibility to previous oscilloscopes. Use the :SAVE:MASK[:START] command (see [page 737](#)) instead.

See Also · ["Introduction to :MTESt Commands"](#) on page 583

:MTESt:AVERage

O (see [page 1384](#))

Command Syntax :MTESt:AVERage <on_off>
<on_off> ::= {{1 | ON} | {0 | OFF}}

The :MTESt:AVERage command enables or disables averaging. When ON, the oscilloscope acquires multiple data values for each time bucket, and averages them. When OFF, averaging is disabled. To set the number of averages, use the :MTESt:AVERage:COUNT command described next.

NOTE

The :MTESt:AVERage command is obsolete and is provided for backward compatibility to previous oscilloscopes. Use the :ACQure:TYPE AVERage command (see [page 265](#)) instead.

Query Syntax :MTESt:AVERage?

The :MTESt:AVERage? query returns the current setting for averaging.

Return Format <on_off><NL>
<on_off> ::= {1 | 0}

- See Also**
- ["Introduction to :MTESt Commands"](#) on page 583
 - [":MTESt:AVERage:COUNT"](#) on page 1325

:MTESt:AVERAge:COUNT

O (see [page 1384](#))

Command Syntax :MTESt:AVERAge:COUNT <count>

<count> ::= an integer from 2 to 65536 in NR1 format

The :MTESt:AVERAge:COUNT command sets the number of averages for the waveforms. With the AVERAge acquisition type, the :MTESt:AVERAge:COUNT command specifies the number of data values to be averaged for each time bucket before the acquisition is considered complete for that time bucket.

NOTE

The :MTESt:AVERAge:COUNT command is obsolete and is provided for backward compatibility to previous oscilloscopes. Use the :ACQuire:COUNT command (see [page 256](#)) instead.

Query Syntax :MTESt:AVERAge:COUNT?

The :MTESt:AVERAge:COUNT? query returns the currently selected count value.

Return Format <count><NL>

<count> ::= an integer from 2 to 65536 in NR1 format

- See Also**
- ["Introduction to :MTESt Commands"](#) on page 583
 - [":MTESt:AVERAge"](#) on page 1324

:MTEST:LOAD

O (see [page 1384](#))

Command Syntax :MTEST:LOAD "<filename>"

The :MTEST:LOAD command loads the specified mask file.

The <filename> parameter is an MS-DOS compatible name of the file, a maximum of 254 characters long (including the path name, if used).

NOTE

The :MTEST:LOAD command is obsolete and is provided for backward compatibility to previous oscilloscopes. Use the :RECall:MASK[:START] command (see [page 721](#)) instead.

- See Also**
- ["Introduction to :MTEST Commands"](#) on page 583
 - [":MTEST:AMASK:{SAVE | STORE}"](#) on page 1323

:MTESt:RUMode

O (see [page 1384](#))

Command Syntax :MTESt:RUMode {FORever | TIME,<seconds> | {WAVEforms,<wfm_count>}}

<seconds> ::= from 1 to 86400 in NR3 format

<wfm_count> ::= number of waveforms in NR1 format
from 1 to 1,000,000,000

The :MTESt:RUMode command determines the termination conditions for the mask test. The choices are FORever, TIME, or WAVEforms.

- FORever – runs the Mask Test until the test is turned off.
- TIME – sets the amount of time in seconds that a mask test will run before it terminates. The <seconds> parameter is a real number from 1 to 86400 seconds.
- WAVEforms – sets the maximum number of waveforms that are required before the mask test terminates. The <wfm_count> parameter indicates the number of waveforms that are to be acquired; it is an integer from 1 to 1,000,000,000.

NOTE

The :MTESt:RUMode command is obsolete and is provided for backward compatibility to previous oscilloscopes. Use the :MTESt:RMODE command (see [page 600](#)) instead.

Query Syntax :MTESt:RUMode?

The :MTESt:RUMode? query returns the currently selected termination condition and value.

Return Format {FOR | TIME,<seconds> | {WAV,<wfm_count>}}<NL>

<seconds> ::= from 1 to 86400 in NR3 format

<wfm_count> ::= number of waveforms in NR1 format
from 1 to 1,000,000,000

- See Also**
- ["Introduction to :MTESt Commands"](#) on page 583
 - [":MTESt:RUMode:SOFailure"](#) on page 1328

`:MTESt:RUMode:SOFailure`

O (see [page 1384](#))

Command Syntax `:MTESt:RUMode:SOFailure <on_off>`
`<on_off> ::= {{1 | ON} | {0 | OFF}}`

The `:MTESt:RUMode:SOFailure` command enables or disables the Stop On Failure run until criteria. When a mask test is run and a mask violation is detected, the mask test is stopped and the acquisition system is stopped.

NOTE

The `:MTESt:RUMode:SOFailure` command is obsolete and is provided for backward compatibility to previous oscilloscopes. Use the `:MTESt:RMODE:FACTion:STOP` command (see [page 604](#)) instead.

Query Syntax `:MTESt:RUMode:SOFailure?`

The `:MTESt:RUMode:SOFailure?` query returns the current state of the Stop on Failure control.

Return Format `<on_off><NL>`
`<on_off> ::= {1 | 0}`

- See Also**
- ["Introduction to :MTESt Commands"](#) on page 583
 - [":MTESt:RUMode"](#) on page 1327

:MTEST:{START | STOP}

O (see [page 1384](#))

Command Syntax :MTEST:{START | STOP}

The :MTEST:{START | STOP} command starts or stops the acquisition system.

NOTE

The :MTEST:START and :MTEST:STOP commands are obsolete and are provided for backward compatibility to previous oscilloscopes. Use the :RUN command (see [page 246](#)) and :STOP command (see [page 250](#)) instead.

See Also · ["Introduction to :MTEST Commands"](#) on page 583

:MTESt:TRIGger:SOURce

O (see [page 1384](#))

Command Syntax :MTESt:TRIGger:SOURce <source>

<source> ::= CHANnel<n>

<n> ::= 1 to (# analog channels) in NR1 format

The :MTESt:TRIGger:SOURce command sets the channel to use as the trigger.

NOTE

The :MTESt:TRIGger:SOURce command is obsolete and is provided for backward compatibility to previous oscilloscopes. Use the trigger source commands (see [page 1097](#)) instead.

Query Syntax :MTESt:TRIGger:SOURce?

The :MTESt:TRIGger:SOURce? query returns the currently selected trigger source.

Return Format <source> ::= CHAN<n>

<n> ::= 1 to (# analog channels) in NR1 format

See Also • ["Introduction to :MTESt Commands"](#) on page 583

:PRINT?

O (see [page 1384](#))

Query Syntax :PRINT? [<options>]

<options> ::= [<print option>][,...,<print option>]

<print option> ::= {COLor | GRAYscale | BMP8bit | BMP}

The :PRINT? query pulls image data back over the bus for storage.

NOTE

The :PRINT command is an obsolete command provided for compatibility to previous oscilloscopes. Use the :DISPlay:DATA command (see [page 351](#)) instead.

Print Option	:PRINt command	:PRINt? query	Query Default
COLor	Sets palette=COLor		
GRAYscale	Sets palette=GRAYscale		palette=COLor
PRINter0,1	Causes the USB printer #0,1 to be selected as destination (if connected)	Not used	N/A
BMP8bit	Sets print format to 8-bit BMP	Selects 8-bit BMP formatting for query	N/A
BMP	Sets print format to BMP	Selects BMP formatting for query	N/A
FACTors	Selects outputting of additional settings information for :PRINT	Not used	N/A
NOFactors	Deselects outputting of additional settings information for :PRINT	Not used	N/A

Old Print Option:	Is Now:
HIRes	COLor
LORes	GRAYscale
PARallel	PRINter0
DISK	invalid
PCL	invalid

NOTE

The PRINT? query is not a core command.

- See Also**
- ["Introduction to Root \(:.\) Commands"](#) on page 216
 - ["Introduction to :HARDcopy Commands"](#) on page 432
 - [":HARDcopy:FACTors"](#) on page 435
 - [":HARDcopy:GRAYscale"](#) on page 1307
 - [":DISPlay:DATA"](#) on page 351

:SAVE:IMAGe:AREA

O (see [page 1384](#))

Query Syntax :SAVE:IMAGe:AREA?

The :SAVE:IMAGe:AREA? query returns the selected image area.

When saving images, this query returns SCR (screen). When saving setups or waveform data, this query returns GRAT (graticule) even though graticule images are not saved.

Return Format <area><NL>

<area> ::= {GRAT | SCR}

- See Also**
- ["Introduction to :SAVE Commands"](#) on page 727
 - [":SAVE:IMAGe\[:START\]"](#) on page 731
 - [":SAVE:IMAGe:FACTors"](#) on page 732
 - [":SAVE:IMAGe:FORMat"](#) on page 733
 - [":SAVE:IMAGe:INKSaver"](#) on page 734
 - [":SAVE:IMAGe:PALette"](#) on page 735

:SBUS<n>:LIN:SIGNal:DEFinition

O (see [page 1384](#))

Command Syntax :SBUS<n>:LIN:SIGNal:DEFinition <value>

<value> ::= {LIN | RX | TX}

The :SBUS<n>:LIN:SIGNal:DEFinition command sets the LIN signal type. These signals can be set to:

Dominant low signals:

- LIN – the actual LIN single-end bus signal line.
- RX – the Receive signal from the LIN bus transceiver.
- TX – the Transmit signal to the LIN bus transceiver.

NOTE

This command is available, but the only legal value is LIN.

Query Syntax :SBUS<n>:LIN:SIGNal:DEFinition?

The :SBUS<n>:LIN:SIGNal:DEFinition? query returns the current LIN signal type.

Return Format <value><NL>

<value> ::= LIN

- See Also**
- ["Introduction to :TRIGger Commands"](#) on page 1097
 - [":TRIGger:MODE"](#) on page 1106
 - [":SBUS<n>:LIN:SIGNal:BAUDrate"](#) on page 877
 - [":SBUS<n>:LIN:SOURce"](#) on page 878

:SBUS<n>:SPI:SOURce:DATA

O (see [page 1384](#))

Command Syntax :SBUS<n>:SPI:SOURce:DATA <source>

<source> ::= {CHANnel<n> | EXTernal} for the DSO models

<source> ::= {CHANnel<n> | DIGital<d>} for the MSO models

<n> ::= 1 to (# analog channels) in NR1 format

<d> ::= 0 to (# digital channels - 1) in NR1 format

The :SBUS<n>:SPI:SOURce:DATA command sets the source for the SPI serial MOSI data.

This command is the same as the :SBUS<n>:SPI:SOURce:MOSI command.

Query Syntax :SBUS<n>:SPI:SOURce:DATA?

The :SBUS<n>:SPI:SOURce:DATA? query returns the current source for the SPI serial MOSI data.

Return Format <source><NL>

- See Also**
- ["Introduction to :TRIGger Commands"](#) on page 1097
 - [":SBUS<n>:SPI:SOURce:MOSI"](#) on page 939
 - [":SBUS<n>:SPI:SOURce:MISO"](#) on page 938
 - [":SBUS<n>:SPI:SOURce:CLOCK"](#) on page 936
 - [":SBUS<n>:SPI:SOURce:FRAME"](#) on page 937
 - [":SBUS<n>:SPI:TRIGger:PATtern:MISO:DATA"](#) on page 940
 - [":SBUS<n>:SPI:TRIGger:PATtern:MOSI:DATA"](#) on page 942
 - [":SBUS<n>:SPI:TRIGger:PATtern:MISO:WIDTH"](#) on page 941
 - [":SBUS<n>:SPI:TRIGger:PATtern:MOSI:WIDTH"](#) on page 943

:SYSTem:MENU

O (see [page 1384](#))

Command Syntax :SYSTem:MENU <menu>

<menu> ::= {MASK | MEASure | SEGmented | LISTer | POWER}

The :SYSTem:MENU command changes the front panel softkey menu.

:TIMebase:DELAy

O (see [page 1384](#))

Command Syntax :TIMebase:DELAy <delay_value>

<delay_value> ::= time in seconds from trigger to the delay reference point on the screen.

The valid range for delay settings depends on the time/division setting for the main time base.

The :TIMebase:DELAy command sets the main time base delay. This delay is the time between the trigger event and the delay reference point on the screen. The delay reference point is set with the :TIMebase:REFErrence command (see [page 1090](#)).

NOTE

The :TIMebase:DELAy command is obsolete and is provided for backward compatibility to previous oscilloscopes. Use the :TIMebase:POSition command (see [page 1088](#)) instead.

Query Syntax :TIMebase:DELAy?

The :TIMebase:DELAy query returns the current delay value.

Return Format <delay_value><NL>

<delay_value> ::= time from trigger to display reference in seconds in NR3 format.

Example Code

```
' TIMEBASE_DELAY - Sets the time base delay. This delay
' is the internal time between the trigger event and the
' onscreen delay reference point.

' Set time base delay to 0.0.
myScope.WriteString ":TIMEBASE:DELAY 0.0"
```

See complete example programs at: [Chapter 42](#), “Programming Examples,” starting on page 1393

:TRIGger:THReshold

O (see [page 1384](#))

Command Syntax :TRIGger:THReshold <channel group>, <threshold type> [, <value>]
 <channel group> ::= {POD1 | POD2}
 <threshold type> ::= {CMOS | ECL | TTL | USERdef}
 <value> ::= voltage for USERdef (floating-point number) [Volt type]
 [Volt type] ::= {V | mV | uV}

The :TRIGger:THReshold command sets the threshold (trigger level) for a pod of 8 digital channels (either digital channels 0 through 7 or 8 through 15). The threshold can be set to a predefined value or to a user-defined value. For the predefined value, the voltage parameter is not required.

NOTE

This command is only available on the MSO models.

NOTE

The :TRIGger:THReshold command is an obsolete command provided for compatibility to previous oscilloscopes. Use the :POD<n>:THReshold command (see [page 619](#)), :DIGital<d>:THReshold command (see [page 339](#)), or :TRIGger[:EDGE]:LEVel command (see [page 1123](#)).

Query Syntax :TRIGger:THReshold? <channel group>

The :TRIGger:THReshold? query returns the voltage and threshold text for analog channel 1 or 2, or POD1 or POD2.

Return Format

<threshold type>[, <value>]<NL>
 <threshold type> ::= {CMOS | ECL | TTL | USER}
 CMOS ::= 2.5V
 TTL ::= 1.5V
 ECL ::= -1.3V
 USERdef ::= range from -8.0V to +8.0V.
 <value> ::= voltage for USERdef (a floating-point number in NR1).

:TRIGger:TV:TVMode

O (see [page 1384](#))

Command Syntax :TRIGger:TV:TVMode <mode>

```
<mode> ::= {FIEld1 | FIEld2 | AFIElds | ALINes | LINE | VERTical
            | LFIeld1 | LFIeld2 | LALTernate | LVERTical}
```

The :TRIGger:TV:MODE command selects the TV trigger mode and field. The LVERTical parameter is only available when :TRIGger:TV:STANdard is GENeric. The LALTernate parameter is not available when :TRIGger:TV:STANdard is GENeric (see [page 1177](#)).

Old forms for <mode> are accepted:

<mode>	Old Forms Accepted
FIEld1	F1
FIEld2	F2
AFIEld	ALLFields, ALLFLDS
ALINes	ALLLines
LFIeld1	LINEF1, LINEFIELD1
LFIeld2	LINEF2, LINEFIELD2
LALTernate	LINEAlt
LVERTical	LINEVert

NOTE

The :TRIGger:TV:TVMode command is an obsolete command provided for compatibility to previous oscilloscopes. Use the :TRIGger:TV:MODE command (see [page 1174](#)) instead.

Query Syntax :TRIGger:TV:TVMode?

The :TRIGger:TV:TVMode? query returns the TV trigger mode.

Return Format <value><NL>

```
<value> ::= {FIE1 | FIE2 | AF1 | ALIN | LINE | VERT | LFI1 | LFI2
            | LALT | LVER}
```

38 Error Messages

-440, Query UNTERMINATED after indefinite response

-430, Query DEADLOCKED

-420, Query UNTERMINATED

-410, Query INTERRUPTED

-400, Query error

-340, Calibration failed

-330, Self-test failed

-321, Out of memory

-320, Storage fault

-315, Configuration memory lost

-314, Save/recall memory lost

-313, Calibration memory lost

-311, Memory error

-310, System error

-300, Device specific error

-278, Macro header not found

-277, Macro redefinition not allowed

-276, Macro recursion error

-273, Illegal macro label

-272, Macro execution error

-258, Media protected

-257, File name error

-256, File name not found

-255, Directory full

-254, Media full

-253, Corrupt media

-252, Missing media

-251, Missing mass storage

-250, Mass storage error

-241, Hardware missing

This message can occur when a feature is unavailable or unlicensed.

For example, serial bus decode commands (which require a four-channel oscilloscope) are unavailable on two-channel oscilloscopes, and some serial bus decode commands are only available on four-channel oscilloscopes when the AMS (automotive serial decode) or LSS (low-speed serial decode) options are licensed.

-240, Hardware error

-231, Data questionable

-230, Data corrupt or stale

-224, Illegal parameter value

-223, Too much data

-222, Data out of range

-221, Settings conflict

-220, Parameter error

-200, Execution error

-183, Invalid inside macro definition

-181, Invalid outside macro definition

-178, Expression data not allowed

-171, Invalid expression

-170, Expression error

-168, Block data not allowed

-161, Invalid block data

- 158, String data not allowed
- 151, Invalid string data
- 150, String data error
- 148, Character data not allowed
- 138, Suffix not allowed
- 134, Suffix too long
- 131, Invalid suffix
- 128, Numeric data not allowed
- 124, Too many digits
- 123, Exponent too large
- 121, Invalid character in number
- 120, Numeric data error
- 114, Header suffix out of range

- 113, Undefined header

- 112, Program mnemonic too long

- 109, Missing parameter

- 108, Parameter not allowed

- 105, GET not allowed

- 104, Data type error

- 103, Invalid separator

- 102, Syntax error

- 101, Invalid character

- 100, Command error

- +10, Software Fault Occurred

- +100, File Exists

- +101, End-Of-File Found

+102, Read Error

+103, Write Error

+104, Illegal Operation

+105, Print Canceled

+106, Print Initialization Failed

+107, Invalid Trace File

+108, Compression Error

+109, No Data For Operation

A remote operation wants some information, but there is no information available. For example, you may request a stored TIFF image using the :DISPlay:DATA? query, but there may be no image stored.

+112, Unknown File Type

+113, Directory Not Supported

39 Status Reporting

Status Reporting Data Structures	/ 1351
Status Byte Register (STB)	/ 1354
Service Request Enable Register (SRE)	/ 1356
Trigger Event Register (TER)	/ 1357
Output Queue	/ 1358
Message Queue	/ 1359
(Standard) Event Status Register (ESR)	/ 1360
(Standard) Event Status Enable Register (ESE)	/ 1361
Error Queue	/ 1362
Operation Status Event Register (:OPERRegister[:EVENT])	/ 1363
Operation Status Condition Register (:OPERRegister:CONDition)	/ 1364
Arm Event Register (AER)	/ 1365
Overload Event Register (:OVLRegister)	/ 1366
Hardware Event Event Register (:HWERRegister[:EVENT])	/ 1367
Hardware Event Condition Register (:HWERRegister:CONDition)	/ 1368
Mask Test Event Event Register (:MTERRegister[:EVENT])	/ 1369
Clearing Registers and Queues	/ 1370
Status Reporting Decision Chart	/ 1371

IEEE 488.2 defines data structures, commands, and common bit definitions for status reporting (for example, the Status Byte Register and the Standard Event Status Register). There are also instrument-defined structures and bits (for example, the Operation Status Event Register and the Overload Event Register).

An overview of the oscilloscope's status reporting structure is shown in the following block diagram. The status reporting structure allows monitoring specified events in the oscilloscope. The ability to monitor and report these events allows determination of such things as the status of an operation, the availability and reliability of the measured data, and more.

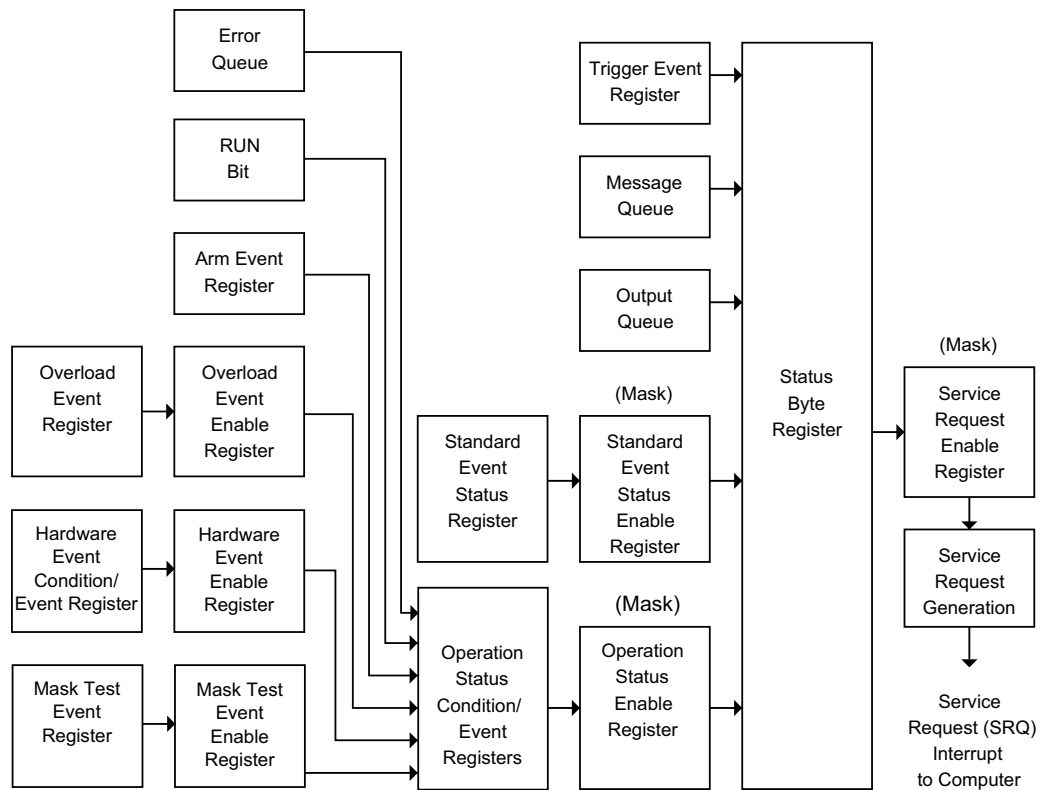

- To monitor an event, first clear the event; then, enable the event. All of the events are cleared when you initialize the instrument.
- To allow a service request (SRQ) interrupt to an external controller, enable at least one bit in the Status Byte Register (by setting, or unmasking, the bit in the Service Request Enable register).

The Status Byte Register, the Standard Event Status Register group, and the Output Queue are defined as the Standard Status Data Structure Model in IEEE 488.2-1987.

The bits in the status byte act as summary bits for the data structures residing behind them. In the case of queues, the summary bit is set if the queue is not empty. For registers, the summary bit is set if any enabled bit in the event register is set. The events are enabled with the corresponding event enable register. Events captured by an event register remain set until the register is read or cleared. Registers are read with their associated commands. The *CLS command clears all event registers and all queues except the output queue. If you send *CLS immediately after a program message terminator, the output queue is also cleared.

Status Reporting Data Structures

The following figure shows how the status register bits are masked and logically OR'ed to generate service requests (SRQ) on particular events.

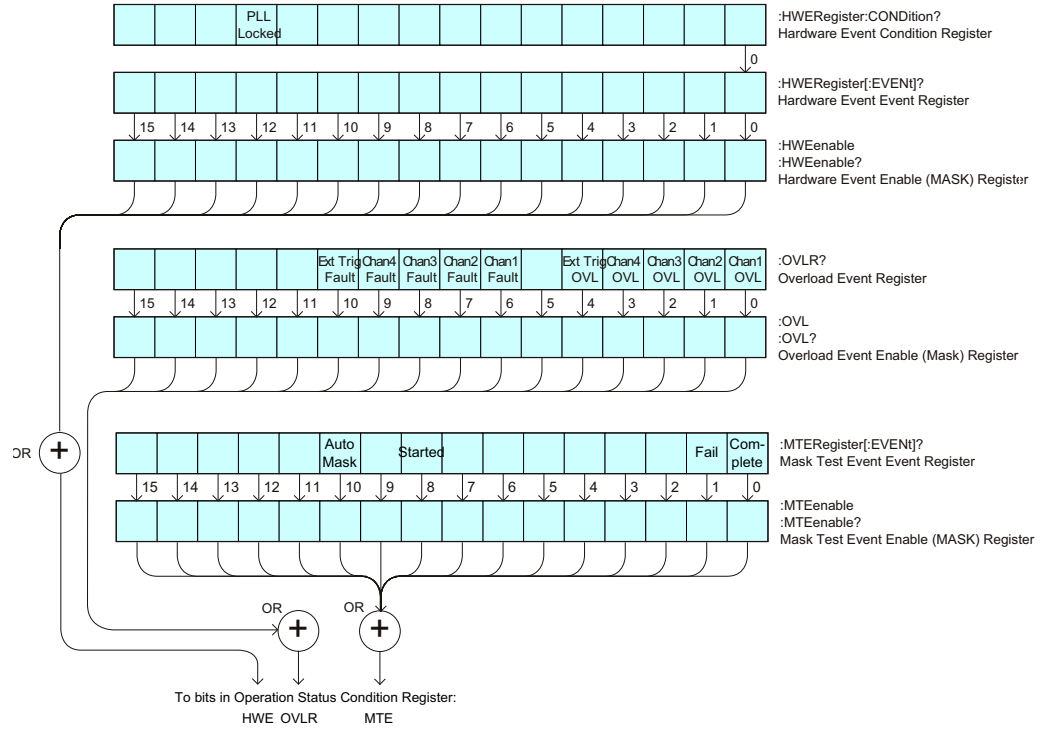

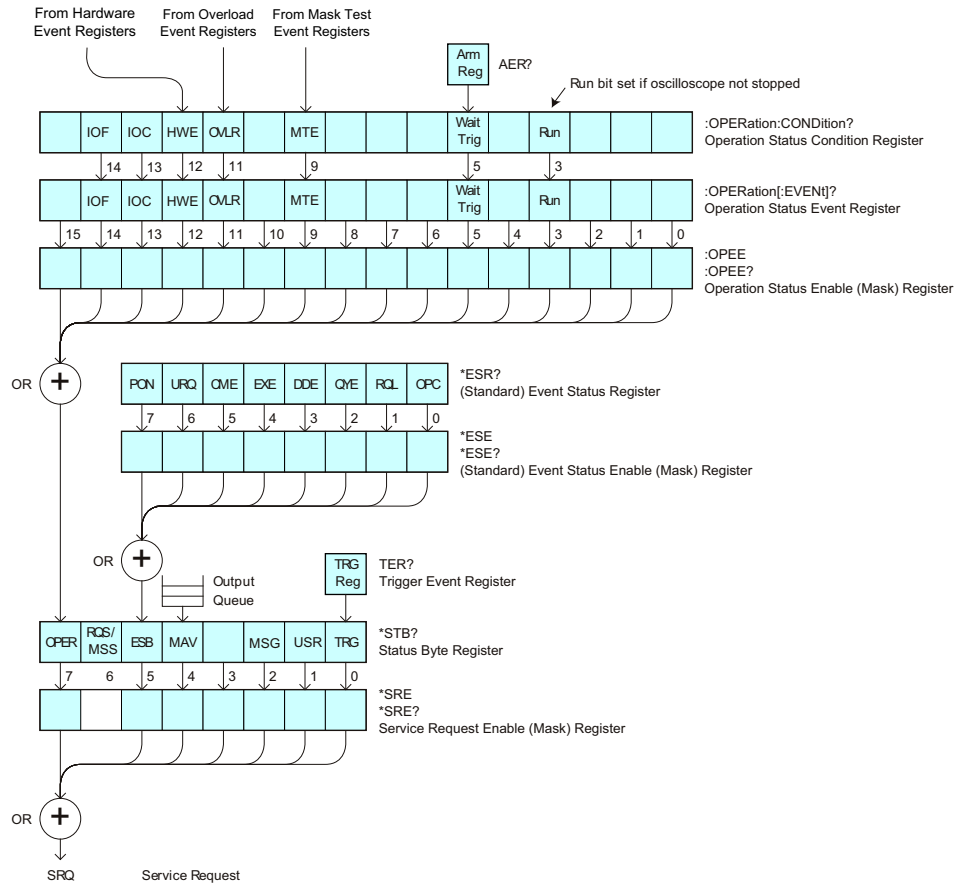

The status register bits are described in more detail in the following tables:

- [Table 77](#)
- [Table 75](#)
- [Table 85](#)
- [Table 86](#)
- [Table 88](#)
- [Table 80](#)
- [Table 81](#)
- [Table 83](#)

The status registers picture above shows how the different status reporting data structures work together. To make it possible for any of the Standard Event Status Register bits to generate a summary bit, the bits must be enabled. These bits are enabled by using the *ESE common command to set the corresponding bit in the Standard Event Status Enable Register.

To generate a service request (SRQ) interrupt to an external controller, at least one bit in the Status Byte Register must be enabled. These bits are enabled by using the *SRE common command to set the corresponding bit in the Service Request Enable Register. These enabled bits can then set RQS and MSS (bit 6) in the Status Byte Register.

Status Byte Register (STB)

The Status Byte Register is the summary-level register in the status reporting structure. It contains summary bits that monitor activity in the other status registers and queues. The Status Byte Register is a live register. That is, its summary bits are set and cleared by the presence and absence of a summary bit from other event registers or queues.

If the Status Byte Register is to be used with the Service Request Enable Register to set bit 6 (RQS/MSS) and to generate an SRQ, at least one of the summary bits must be enabled, then set. Also, event bits in all other status registers must be specifically enabled to generate the summary bit that sets the associated summary bit in the Status Byte Register.

The Status Byte Register can be read using either the *STB? Common Command or the programming interface serial poll command. Both commands return the decimal-weighted sum of all set bits in the register. The difference between the two methods is that the serial poll command reads bit 6 as the Request Service (RQS) bit and clears the bit which clears the SRQ interrupt. The *STB? command reads bit 6 as the Master Summary Status (MSS) and does not clear the bit or have any affect on the SRQ interrupt. The value returned is the total bit weights of all of the bits that are set at the present time.

The use of bit 6 can be confusing. This bit was defined to cover all possible computer interfaces, including a computer that could not do a serial poll. The important point to remember is that, if you are using an SRQ interrupt to an external computer, the serial poll command clears bit 6. Clearing bit 6 allows the oscilloscope to generate another SRQ interrupt when another enabled event occurs.

No other bits in the Status Byte Register are cleared by either the *STB? query or the serial poll, except the Message Available bit (bit 4). If there are no other messages in the Output Queue, bit 4 (MAV) can be cleared as a result of reading the response to the *STB? command.

If bit 4 (weight = 16) and bit 5 (weight = 32) are set, the program prints the sum of the two weights. Since these bits were not enabled to generate an SRQ, bit 6 (weight = 64) is not set.

The following example uses the *STB? query to read the contents of the oscilloscope's Status Byte Register.

```
myScope.WriteString "*STB?"
varQueryResult = myScope.ReadNumber
MsgBox "Status Byte Register, Read: 0x" + Hex(varQueryResult)
```

The next program prints 0xD1 and clears bit 6 (RQS) and bit 4 (MAV) of the Status Byte Register. The difference in the output value between this example and the previous one is the value of bit 6 (weight = 64). Bit 6 is set when the first enabled summary bit is set and is cleared when the Status Byte Register is read by the serial poll command.

Example The following example uses the resource session object's ReadSTB method to read the contents of the oscilloscope's Status Byte Register.

```
varQueryResult = myScope.IO.ReadSTB  
MsgBox "Status Byte Register, Serial Poll: 0x" + Hex(varQueryResult)
```

NOTE

Use Serial Polling to Read Status Byte Register. Serial polling is the preferred method to read the contents of the Status Byte Register because it resets bit 6 and allows the next enabled event that occurs to generate a new SRQ interrupt.

Service Request Enable Register (SRE)

Setting the Service Request Enable Register bits enable corresponding bits in the Status Byte Register. These enabled bits can then set RQS and MSS (bit 6) in the Status Byte Register.

Bits are set in the Service Request Enable Register using the *SRE command and the bits that are set are read with the *SRE? query.

Example The following example sets bit 4 (MAV) and bit 5 (ESB) in the Service Request Enable Register.

```
myScope.WriteString "*SRE " + CStr(CInt("&H30"))
```

This example uses the decimal parameter value of 48, the string returned by CStr(CInt("&H30")), to enable the oscilloscope to generate an SRQ interrupt under the following conditions:

- When one or more bytes in the Output Queue set bit 4 (MAV).
- When an enabled event in the Standard Event Status Register generates a summary bit that sets bit 5 (ESB).

Trigger Event Register (TER)

This register sets the TRG bit in the status byte when a trigger event occurs.

The TER event register stays set until it is cleared by reading the register or using the *CLS command. If your application needs to detect multiple triggers, the TER event register must be cleared after each one.

If you are using the Service Request to interrupt a program or controller operation, you must clear the event register each time the trigger bit is set.

Output Queue

The output queue stores the oscilloscope-to-controller responses that are generated by certain instrument commands and queries. The output queue generates the Message Available summary bit when the output queue contains one or more bytes. This summary bit sets the MAV bit (bit 4) in the Status Byte Register.

When using the Keysight VISA COM library, the output queue may be read with the FormattedIO488 object's ReadString, ReadNumber, ReadList, or ReadIEEEBlock methods.

Message Queue

The message queue contains the text of the last message written to the advisory line on the screen of the oscilloscope. The length of the oscilloscope's message queue is 1. Note that messages sent with the :SYSTem:DSP command do not set the MSG status bit in the Status Byte Register.

(Standard) Event Status Register (ESR)

The (Standard) Event Status Register (ESR) monitors the following oscilloscope status events:

- PON - Power On
- URQ - User Request
- CME - Command Error
- EXE - Execution Error
- DDE - Device Dependent Error
- QYE - Query Error
- RQC - Request Control
- OPC - Operation Complete

When one of these events occur, the event sets the corresponding bit in the register. If the bits are enabled in the Standard Event Status Enable Register, the bits set in this register generate a summary bit to set bit 5 (ESB) in the Status Byte Register.

You can read the contents of the Standard Event Status Register and clear the register by sending the *ESR? query. The value returned is the total bit weights of all of the bits that are set at the present time.

Example The following example uses the *ESR query to read the contents of the Standard Event Status Register.

```
myScope.WriteString "*ESR?"  
varQueryResult = myScope.ReadNumber  
MsgBox "Standard Event Status Register: 0x" + Hex(varQueryResult)
```

If bit 4 (weight = 16) and bit 5 (weight = 32) are set, the program prints the sum of the two weights.

(Standard) Event Status Enable Register (ESE)

To allow any of the (Standard) Event Status Register (ESR) bits to generate a summary bit, you must first enable that bit. Enable the bit by using the *ESE (Event Status Enable) common command to set the corresponding bit in the (Standard) Event Status Enable Register (ESE).

Set bits are read with the *ESE? query.

Example Suppose your application requires an interrupt whenever any type of error occurs. The error related bits in the (Standard) Event Status Register are bits 2 through 5 (hexadecimal value 0x3C). Therefore, you can enable any of these bits to generate the summary bit by sending:

```
myScope.WriteString "*ESE " + CStr(CInt("&H3C"))
```

Whenever an error occurs, it sets one of these bits in the (Standard) Event Status Register. Because all the error related bits are enabled, a summary bit is generated to set bit 5 (ESB) in the Status Byte Register.

If bit 5 (ESB) in the Status Byte Register is enabled (via the *SRE command), an SRQ service request interrupt is sent to the controller PC.

NOTE

Disabled (Standard) Event Status Register bits respond but do not generate a summary bit. (Standard) Event Status Register bits that are not enabled still respond to their corresponding conditions (that is, they are set if the corresponding event occurs). However, because they are not enabled, they do not generate a summary bit to the Status Byte Register.

Error Queue

As errors are detected, they are placed in an error queue. This queue is first in, first out. If the error queue overflows, the last error in the queue is replaced with error 350, Queue overflow. Any time the queue overflows, the least recent errors remain in the queue, and the most recent error is discarded. The length of the oscilloscope's error queue is 30 (29 positions for the error messages, and 1 position for the Queue overflow message).

The error queue is read with the :SYSTem:ERRor? query. Executing this query reads and removes the oldest error from the head of the queue, which opens a position at the tail of the queue for a new error. When all the errors have been read from the queue, subsequent error queries return "0, No error".

The error queue is cleared when:

- the instrument is powered up,
- the instrument receives the *CLS common command, or
- the last item is read from the error queue.

Operation Status Event Register (:OPERRegister[:EVENT])

The Operation Status Event Register register hosts these bits:

Name	Location	Description
RUN bit	bit 3	Is set whenever the instrument goes from a stop state to a single or running state.
WAIT TRIG bit	bit 5	Is set by the Trigger Armed Event Register and indicates that the trigger is armed.
MTE bit	bit 9	Comes from the Mask Test Event Registers.
OVLRL bit	bit 11	Is set whenever a 50Ω input overload occurs.
HWE bit	bit 12	Comes from the Hardware Event Registers.
IOC bit	bit 13	Is set when the IO operation completes.
IOF bit	bit 14	Is set when the IO operation fails.

If any of these bits are set, the OPER bit (bit 7) of the Status Byte Register is set. The Operation Status Event Register is read and cleared with the :OPERRegister[:EVENT]? query. The register output is enabled or disabled using the mask value supplied with the OPEE command.

Operation Status Condition Register (:OPERRegister:CONDition)

The Operation Status Condition Register register hosts these bits:

Name	Location	Description
RUN bit	bit 3	Is set whenever the instrument is not stopped.
WAIT TRIG bit	bit 5	Is set by the Trigger Armed Event Register and indicates that the trigger is armed.
MTE bit	bit 9	Comes from the Mask Test Event Registers.
OVLr bit	bit 11	Is set whenever a 50Ω input overload occurs.
HWE bit	bit 12	Comes from the Hard ware Event Registers.
IOC bit	bit 13	Is set when the IO operation completes.
IOF bit	bit 14	Is set when the IO operation fails.

The :OPERRegister:CONDition? query returns the value of the Operation Status Condition Register.

Arm Event Register (AER)

This register sets bit 5 (Wait Trig bit) in the Operation Status Register and the OPER bit (bit 7) in the Status Byte Register when the instrument becomes armed.

The ARM event register stays set until it is cleared by reading the register with the AER? query or using the *CLS command. If your application needs to detect multiple triggers, the ARM event register must be cleared after each one.

If you are using the Service Request to interrupt a program or controller operation when the trigger bit is set, then you must clear the event register after each time it has been set.

Overload Event Register (:OVLRegister)

The Overload Event Register register hosts these bits:

Name	Location	Description
Channel 1 OVL	bit 0	Overload has occurred on Channel 1 input.
Channel 2 OVL	bit 1	Overload has occurred on Channel 2 input.
Channel 3 OVL	bit 2	Overload has occurred on Channel 3 input.
Channel 4 OVL	bit 3	Overload has occurred on Channel 4 input.
External Trigger OVL	bit 4	Overload has occurred on External Trigger input.
Channel 1 Fault	bit 6	Fault has occurred on Channel 1 input.
Channel 2 Fault	bit 7	Fault has occurred on Channel 2 input.
Channel 3 Fault	bit 8	Fault has occurred on Channel 3 input.
Channel 4 Fault	bit 9	Fault has occurred on Channel 4 input.
External Trigger Fault	bit 10	Fault has occurred on External Trigger input.

Hardware Event Event Register (:HWERegister[:EVENT])

This register hosts the PLL LOCKED bit (bit 12).

- The PLL LOCKED bit (bit 12) is for internal use and is not intended for general use.

Hardware Event Condition Register (:HWERegister:CONDition)

This register hosts the PLL LOCKED bit (bit 12).

- The :HWERegister:CONDition? query returns the value of the Hardware Event Condition Register.
- The PLL LOCKED bit (bit 12) is for internal use and is not intended for general use.

Mask Test Event Event Register (:MTERegister[:EVENT])

The Mask Test Event Event Register register hosts these bits:

Name	Location	Description
Complete	bit 0	Is set when the mask test is complete.
Fail	bit 1	Is set when there is a mask test failure.
Started	bit 8	Is set when mask testing is started.
Auto Mask	bit 10	Is set when auto mask creation is completed.

The :MTERegister[:EVENT]? query returns the value of, and clears, the Mask Test Event Event Register.

Clearing Registers and Queues

The *CLS common command clears all event registers and all queues except the output queue. If *CLS is sent immediately after a program message terminator, the output queue is also cleared.

Status Reporting Decision Chart

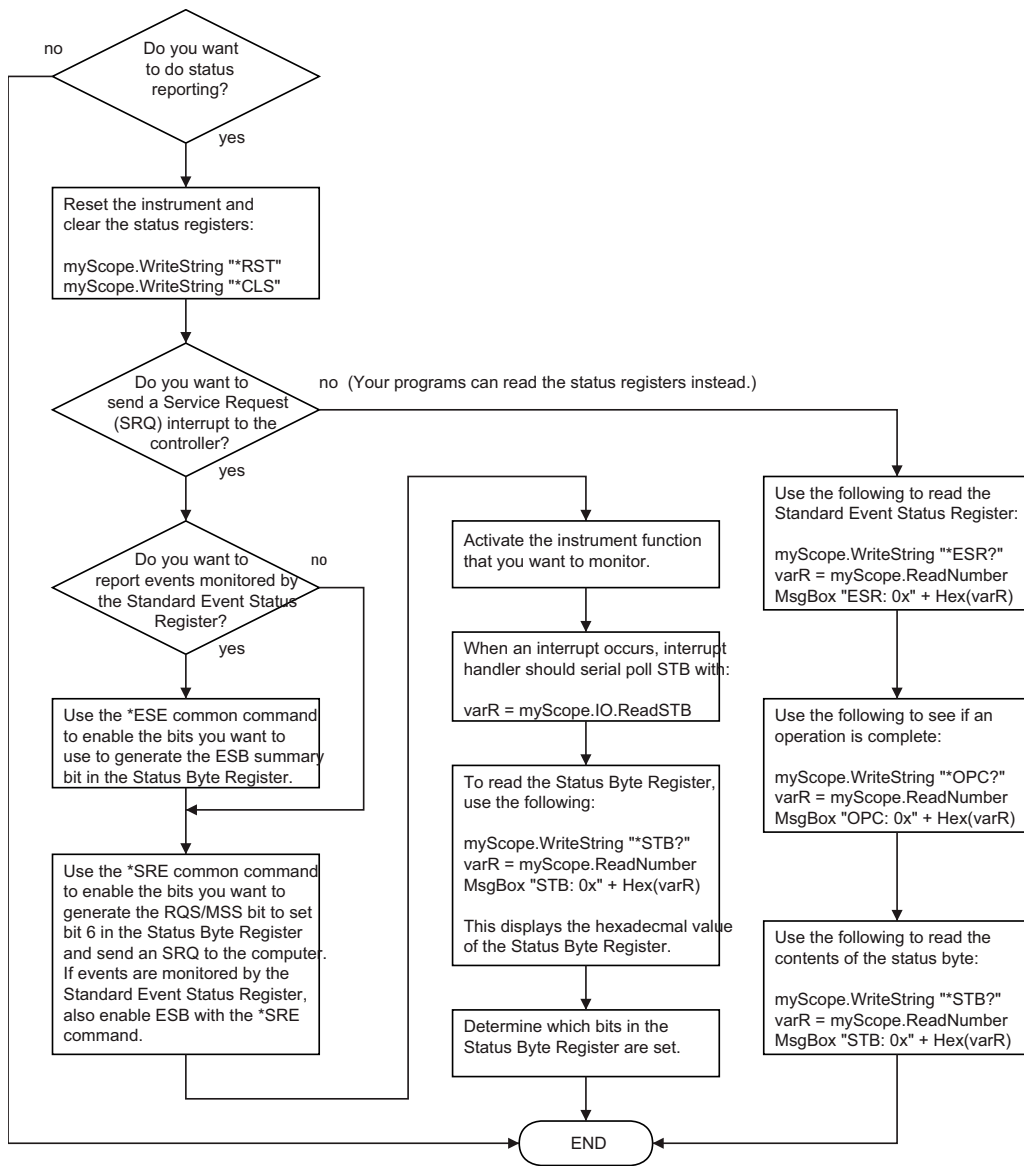

40 Synchronizing Acquisitions

Synchronization in the Programming Flow / 1374

Blocking Synchronization / 1375

Polling Synchronization With Timeout / 1376

Synchronizing with a Single-Shot Device Under Test (DUT) / 1378

Synchronization with an Averaging Acquisition / 1380

When remotely controlling an oscilloscope with programming commands, it is often necessary to know when the oscilloscope has finished the previous operation and is ready for the next command. The most common example is when an acquisition is started using the :DIGitize, :RUN, or :SINGle commands. Before a measurement result can be queried, the acquisition must complete. Too often fixed delays are used to accomplish this wait, but fixed delays often use excessive time or the time may not be long enough. A better solution is to use synchronous commands and status to know when the oscilloscope is ready for the next request.

Synchronization in the Programming Flow

Most remote programming follows these three general steps:

- 1 Set up the oscilloscope and device under test (see [page 1374](#)).
- 2 Acquire a waveform (see [page 1374](#)).
- 3 Retrieve results (see [page 1374](#)).

Set Up the Oscilloscope

Before making changes to the oscilloscope setup, it is best to make sure it is stopped using the :STOP command followed by the *OPC? query.

NOTE

It is not necessary to use *OPC?, hard coded waits, or status checking when setting up the oscilloscope. After the oscilloscope is configured, it is ready for an acquisition.

Acquire a Waveform

When acquiring a waveform there are two possible methods used to wait for the acquisition to complete. These methods are blocking and polling. The table below details when each method should be chosen and why.

	Blocking Wait	Polling Wait
Use When	You know the oscilloscope <i>will</i> trigger based on the oscilloscope setup and device under test.	You know the oscilloscope <i>may or may not</i> trigger on the oscilloscope setup and device under test.
Advantages	No need for polling. Fastest method.	Remote interface will not timeout No need for device clear if no trigger.
Disadvantages	Remote interface may timeout. Device clear only way to get control of oscilloscope if there is no trigger.	Slower method. Requires polling loop. Requires known maximum wait time.
Implementation Details	See " Blocking Synchronization " on page 1375.	See " Polling Synchronization With Timeout " on page 1376.

Retrieve Results

Once the acquisition is complete, it is safe to retrieve measurements and statistics.

Blocking Synchronization

Use the :DIGitize command to start the acquisition. This blocks subsequent queries until the acquisition and processing is complete. For example:

```
'
' Synchronizing acquisition using blocking.
' =====

Option Explicit

Public myMgr As VisaComLib.ResourceManager
Public myScope As VisaComLib.FormattedIO488
Public varQueryResult As Variant
Public strQueryResult As String

Sub Main()

    On Error GoTo VisaComError

    ' Create the VISA COM I/O resource.
    Set myMgr = New VisaComLib.ResourceManager
    Set myScope = New VisaComLib.FormattedIO488
    Set myScope.IO = myMgr.Open("TCPIP0::130.29.69.12::inst0::INSTR")
    myScope.IO.Clear ' Clear the interface.

    ' Set up.
    ' -----
    myScope.WriteString ":TRIGger:MODE EDGE"
    myScope.WriteString ":TRIGger:EDGE:LEVel 2"
    myScope.WriteString ":TIMEbase:SCALE 5e-8"

    ' Acquire.
    ' -----
    myScope.WriteString ":DIGitize"

    ' Get results.
    ' -----
    myScope.WriteString ":MEASure:RISetime"
    myScope.WriteString ":MEASure:RISetime?"
    varQueryResult = myScope.ReadNumber ' Read risetime.
    Debug.Print "Risetime: " + _
        FormatNumber(varQueryResult * 1000000000, 1) + " ns"

    Exit Sub

VisaComError:
    MsgBox "VISA COM Error:" + vbCrLf + Err.Description

End Sub
```

Polling Synchronization With Timeout

This example requires a timeout value so the operation can abort if an acquisition does not occur within the timeout period:

```
'
' Synchronizing acquisition using polling.
' =====

Option Explicit

Public myMgr As VisaComLib.ResourceManager
Public myScope As VisaComLib.FormattedIO488
Public varQueryResult As Variant
Public strQueryResult As String

Private Declare Sub Sleep Lib "kernel32" (ByVal dwMilliseconds As Long)

Sub Main()

    On Error GoTo VisaComError

    ' Create the VISA COM I/O resource.
    Set myMgr = New VisaComLib.ResourceManager
    Set myScope = New VisaComLib.FormattedIO488
    Set myScope.IO = myMgr.Open("TCPIP0::130.29.69.12::inst0::INSTR")
    myScope.IO.Clear ' Clear the interface.

    ' Set up.
    ' -----
    ' Set up the trigger and horizontal scale.
    myScope.WriteString ":TRIGger:MODE EDGE"
    myScope.WriteString ":TRIGger:EDGE:LEVel 2"
    myScope.WriteString ":TIMEbase:SCALE 5e-8"

    ' Stop acquisitions and wait for the operation to complete.
    myScope.WriteString ":STOP"
    myScope.WriteString "*OPC?"
    strQueryResult = myScope.ReadString

    ' Acquire.
    ' -----
    ' Start a single acquisition.
    myScope.WriteString ":SINGle"

    ' Oscilloscope is armed and ready, enable DUT here.
    Debug.Print "Oscilloscope is armed and ready, enable DUT."

    ' Look for RUN bit = stopped (acquisition complete).
    Dim lngTimeout As Long ' Max millisecs to wait for single-shot.
    Dim lngElapsed As Long
    lngTimeout = 10000 ' 10 seconds.
    lngElapsed = 0

    Do While lngElapsed <= lngTimeout
```



```

myScope.WriteString ":OPERRegister:CONDition?"
varQueryResult = myScope.ReadNumber
' Mask RUN bit (bit 3, &H8).
If (varQueryResult And &H8) = 0 Then
  Exit Do
Else
  Sleep 100 ' Small wait to prevent excessive queries.
  lngElapsed = lngElapsed + 100
End If
Loop

' Get results.
' -----
If lngElapsed < lngTimeout Then
  myScope.WriteString ":MEASure:RISetime"
  myScope.WriteString ":MEASure:RISetime?"
  varQueryResult = myScope.ReadNumber ' Read risetime.
  Debug.Print "Risetime: " + _
    FormatNumber(varQueryResult * 1000000000, 1) + " ns"
Else
  Debug.Print "Timeout waiting for single-shot trigger."
End If

Exit Sub

VisaComError:
  MsgBox "VISA COM Error:" + vbCrLf + Err.Description

End Sub

```

Synchronizing with a Single-Shot Device Under Test (DUT)

The examples in **"Blocking Synchronization"** on page 1375 and **"Polling Synchronization With Timeout"** on page 1376 assume the DUT is continually running and therefore the oscilloscope will have more than one opportunity to trigger. With a single shot DUT, there is only one opportunity for the oscilloscope to trigger, so it is necessary for the oscilloscope to be armed and ready before the DUT is enabled.

NOTE

The blocking :DIGitize command cannot be used for a single shot DUT because once the :DIGitize command is issued, the oscilloscope is blocked from any further commands until the acquisition is complete.

This example is the same **"Polling Synchronization With Timeout"** on page 1376 with the addition of checking for the armed event status.

```
'
' Synchronizing single-shot acquisition using polling.
' =====

Option Explicit

Public myMgr As VisaComLib.ResourceManager
Public myScope As VisaComLib.FormattedIO488
Public varQueryResult As Variant
Public strQueryResult As String

Private Declare Sub Sleep Lib "kernel32" (ByVal dwMilliseconds As Long)

Sub Main()

    On Error GoTo VisaComError

    ' Create the VISA COM I/O resource.
    Set myMgr = New VisaComLib.ResourceManager
    Set myScope = New VisaComLib.FormattedIO488
    Set myScope.IO = myMgr.Open("TCPIP0::130.29.69.12::inst0::INSTR")
    myScope.IO.Clear ' Clear the interface.

    ' Set up.
    ' -----
    ' Set up the trigger and horizontal scale.
    myScope.WriteString ":TRIGger:MODE EDGE"
    myScope.WriteString ":TRIGger:EDGE:LEVel 2"
    myScope.WriteString ":TIMEbase:SCALE 5e-8"

    ' Stop acquisitions and wait for the operation to complete.
    myScope.WriteString ":STOP"
    myScope.WriteString "*OPC?"
    strQueryResult = myScope.ReadString

    ' Acquire.
```

```

' -----
' Start a single acquisition.
myScope.WriteString ":SINGLE"

' Wait until the trigger system is armed.
Do
  Sleep 100 ' Small wait to prevent excessive queries.
  myScope.WriteString ":AER?"
  varQueryResult = myScope.ReadNumber
Loop Until varQueryResult = 1

' Oscilloscope is armed and ready, enable DUT here.
Debug.Print "Oscilloscope is armed and ready, enable DUT."

' Now, look for RUN bit = stopped (acquisition complete).
Dim lngTimeout As Long ' Max millisecs to wait for single-shot.
Dim lngElapsed As Long
lngTimeout = 10000 ' 10 seconds.
lngElapsed = 0

Do While lngElapsed <= lngTimeout
  myScope.WriteString ":OPERRegister:CONDITION?"
  varQueryResult = myScope.ReadNumber
  ' Mask RUN bit (bit 3, &H8).
  If (varQueryResult And &H8) = 0 Then
    Exit Do
  Else
    Sleep 100 ' Small wait to prevent excessive queries.
    lngElapsed = lngElapsed + 100
  End If
Loop

' Get results.
' -----
If lngElapsed < lngTimeout Then
  myScope.WriteString ":MEASure:RISetime"
  myScope.WriteString ":MEASure:RISetime?"
  varQueryResult = myScope.ReadNumber ' Read risetime.
  Debug.Print "Risetime: " + _
    FormatNumber(varQueryResult * 1000000000, 1) + " ns"
Else
  Debug.Print "Timeout waiting for single-shot trigger."
End If

Exit Sub

VisaComError:
  MsgBox "VISA COM Error:" + vbCrLf + Err.Description

End Sub

```

Synchronization with an Averaging Acquisition

When averaging, it is necessary to know when the average count has been reached. The :SINGle command does not average.

If it is known that a trigger will occur, a :DIGitize will acquire the complete number of averages, but if the number of averages is large, a timeout on the connection can occur.

The example below polls during the :DIGitize to prevent a timeout on the connection.

```
'
' Synchronizing in averaging acquisition mode.
' =====

Option Explicit

Public myMgr As VisaComLib.ResourceManager
Public myScope As VisaComLib.FormattedIO488
Public varQueryResult As Variant
Public strQueryResult As String

Private Declare Sub Sleep Lib "kernel32" (ByVal dwMilliseconds As Long)

Sub Main()

    On Error GoTo VisaComError

    ' Create the VISA COM I/O resource.
    Set myMgr = New VisaComLib.ResourceManager
    Set myScope = New VisaComLib.FormattedIO488
    Set myScope.IO = myMgr.Open("TCPIP0::130.29.69.12::inst0::INSTR")
    myScope.IO.Clear ' Clear the interface.
    myScope.IO.Timeout = 5000

    ' Set up.
    ' -----
    ' Set up the trigger and horizontal scale.
    myScope.WriteString ":TRIGger:SWEep NORMal"
    myScope.WriteString ":TRIGger:MODE EDGE"
    myScope.WriteString ":TRIGger:EDGE:LEVel 2"
    myScope.WriteString ":TIMEbase:SCALE 5e-8"

    ' Stop acquisitions and wait for the operation to complete.
    myScope.WriteString ":STOP"
    myScope.WriteString "*OPC?"
    strQueryResult = myScope.ReadString

    ' Set up average acquisition mode.
    Dim lngAverages As Long
    lngAverages = 256
    myScope.WriteString ":ACquire:COUNT " + CStr(lngAverages)
    myScope.WriteString ":ACquire:TYPE AVERAge"
```

```

' Save *ESE (Standard Event Status Enable register) mask
' (so it can be restored later).
Dim varInitialESE As Variant
myScope.WriteString "*ESE?"
varInitialESE = myScope.ReadNumber

' Set *ESE mask to allow only OPC (Operation Complete) bit.
myScope.WriteString "*ESE " + CStr(CInt("&H01"))

' Acquire using :DIGitize. Set up OPC bit to be set when the
' operation is complete.
' -----
myScope.WriteString ":DIGitize"
myScope.WriteString "*OPC"

' Assume the oscilloscope will trigger, if not put a check here.

' Wait until OPC becomes true (bit 5 of Status Byte register, STB,
' from Standard Event Status register, ESR, is set). STB can be
' read during :DIGitize without generating a timeout.
Do
Sleep 4000 ' Poll more often than the timeout setting.
varQueryResult = myScope.IO.ReadSTB
Loop While (varQueryResult And &H20) = 0

' Clear ESR and restore previously saved *ESE mask.
myScope.WriteString "*ESR?" ' Clear ESR by reading it.
varQueryResult = myScope.ReadNumber
myScope.WriteString "*ESE " + CStr(varInitialESE)

' Get results.
' -----
myScope.WriteString ":WAVEform:COUNT?"
varQueryResult = myScope.ReadNumber
Debug.Print "Averaged waveforms: " + CStr(varQueryResult)

myScope.WriteString ":MEASure:RISetime"
myScope.WriteString ":MEASure:RISetime?"
varQueryResult = myScope.ReadNumber ' Read risetime.
Debug.Print "Risetime: " + _
FormatNumber(varQueryResult * 1000000000, 1) + " ns"

Exit Sub

VisaComError:
MsgBox "VISA COM Error:" + vbCrLf + Err.Description

End Sub

```

41 More About Oscilloscope Commands

Command Classifications / 1384

Valid Command/Query Strings / 1385

Query Return Values / 1391

All Oscilloscope Commands Are Sequential / 1392

Command Classifications

To help you use existing programs with your oscilloscope, or use current programs with the next generation of Keysight InfiniiVision oscilloscopes, commands are classified by the following categories:

- **"Core Commands"** on page 1384
- **"Non-Core Commands"** on page 1384
- **"Obsolete Commands"** on page 1384

C Core Commands

Core commands are a common set of commands that provide basic oscilloscope functionality on this oscilloscope and future Keysight InfiniiVision oscilloscopes. Core commands are unlikely to be modified in the future. If you restrict your programs to core commands, the programs should work across product offerings in the future, assuming appropriate programming methods are employed.

N Non-Core Commands

Non-core commands are commands that provide specific features, but are not universal across all Keysight InfiniiVision oscilloscope models. Non-core commands may be modified or deleted in the future. With a command structure as complex as the one for your oscilloscope, some evolution over time is inevitable. Keysight's intent is to continue to expand command subsystems, such as the rich and evolving trigger feature set.

O Obsolete Commands

Obsolete commands are older forms of commands that are provided to reduce customer rework for existing systems and programs. Generally, these commands are mapped onto some of the Core and Non-core commands, but may not strictly have the same behavior as the new command. None of the obsolete commands are guaranteed to remain functional in future products. New systems and programs should use the Core (and Non-core) commands. Obsolete commands are listed in:

- **Chapter 37**, "Obsolete and Discontinued Commands," starting on page 1283

Valid Command/Query Strings

- **"Program Message Syntax"** on page 1385
- **"Duplicate Mnemonics"** on page 1389
- **"Tree Traversal Rules and Multiple Commands"** on page 1389

Program Message Syntax

To program the instrument remotely, you must understand the command format and structure expected by the instrument. The IEEE 488.2 syntax rules govern how individual elements such as headers, separators, program data, and terminators may be grouped together to form complete instructions. Syntax definitions are also given to show how query responses are formatted. The following figure shows the main syntactical parts of a typical program statement.

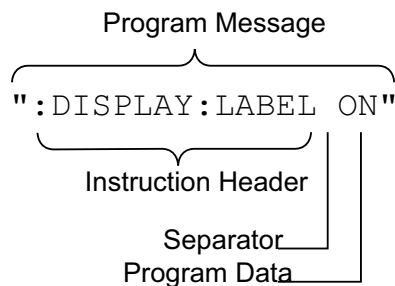

Instructions (both commands and queries) normally appear as a string embedded in a statement of your host language, such as Visual Basic or C/C++. The only time a parameter is not meant to be expressed as a string is when the instruction's syntax definition specifies <block data>, such as <learn string>. There are only a few instructions that use block data.

Program messages can have long or short form commands (and data in some cases – see **"Long Form to Short Form Truncation Rules"** on page 1386), and upper and/or lower case ASCII characters may be used. (Query responses, however, are always returned in upper case.)

Instructions are composed of two main parts:

- The header, which specifies the command or query to be sent.
- The program data, which provide additional information needed to clarify the meaning of the instruction.

Instruction Header The instruction header is one or more mnemonics separated by colons (:) that represent the operation to be performed by the instrument.

":DISPlay:LABel ON" is a command. Queries are indicated by adding a question mark (?) to the end of the header, for example, ":DISPlay:LABel?". Many instructions can be used as either commands or queries, depending on whether or

not you have included the question mark. The command and query forms of an instruction usually have different program data. Many queries do not use any program data.

There are three types of headers:

- **"Simple Command Headers"** on page 1387
- **"Compound Command Headers"** on page 1387
- **"Common Command Headers"** on page 1387

White Space (Separator) White space is used to separate the instruction header from the program data. If the instruction does not require any program data parameters, you do not need to include any white space. White space is defined as one or more space characters. ASCII defines a space to be character 32 (in decimal).

Program Data Program data are used to clarify the meaning of the command or query. They provide necessary information, such as whether a function should be on or off, or which waveform is to be displayed. Each instruction's syntax definition shows the program data, as well as the values they accept. **"Program Data Syntax Rules"** on page 1388 describes all of the general rules about acceptable values.

When there is more than one data parameter, they are separated by commas(,). Spaces can be added around the commas to improve readability.

Program Message Terminator The program instructions within a data message are executed after the program message terminator is received. The terminator may be either an NL (New Line) character, an EOI (End-Of-Identify) asserted in the programming interface, or a combination of the two. Asserting the EOI sets the EOI control line low on the last byte of the data message. The NL character is an ASCII linefeed (decimal 10).

NOTE

New Line Terminator Functions. The NL (New Line) terminator has the same function as an EOS (End Of String) and EOT (End Of Text) terminator.

Long Form to Short Form Truncation Rules

To get the short form of a command/keyword:

- When the command/keyword is longer than four characters, use the first four characters of the command/keyword unless the fourth character is a vowel; when the fourth character is a vowel, use the first three characters of the command/keyword.
- When the command/keyword is four or fewer characters, use all of the characters.

Long Form	Short form
RANGe	RANG
PATTerN	PATT

Long Form	Short form
TIMebase	TIM
DELay	DEL
TYPE	TYPE

In the oscilloscope programmer's documentation, the short form of a command is indicated by uppercase characters.

Programs written in long form are easily read and are almost self-documenting. The short form syntax conserves the amount of controller memory needed for program storage and reduces I/O activity.

Simple Command Headers

Simple command headers contain a single mnemonic. :AUToscale and :DIGitize are examples of simple command headers typically used in the oscilloscope. The syntax is:

```
<program mnemonic><terminator>
```

Simple command headers must occur at the beginning of a program message; if not, they must be preceded by a colon.

When program data must be included with the simple command header (for example, :DIGitize CHANnel1), white space is added to separate the data from the header. The syntax is:

```
<program mnemonic><separator><program data><terminator>
```

Compound Command Headers

Compound command headers are a combination of two or more program mnemonics. The first mnemonic selects the subsystem, and the second mnemonic selects the function within that subsystem. The mnemonics within the compound message are separated by colons. For example, to execute a single function within a subsystem:

```
:<subsystem>:<function><separator><program data><terminator>
```

For example, :CHANnel1:BWLimit ON

Common Command Headers

Common command headers control IEEE 488.2 functions within the instrument (such as clear status). Their syntax is:

```
*<command header><terminator>
```

No space or separator is allowed between the asterisk (*) and the command header. *CLS is an example of a common command header.

Program Data Syntax Rules

Program data is used to convey a parameter information related to the command header. At least one space must separate the command header or query header from the program data.

```
<program mnemonic><separator><data><terminator>
```

When a program mnemonic or query has multiple program data, a comma separates sequential program data.

```
<program mnemonic><separator><data>,<data><terminator>
```

For example, :MEASure:DELay CHANnel1,CHANnel2 has two program data: CHANnel1 and CHANnel2.

Two main types of program data are used in commands: character and numeric.

Character Program Data

Character program data is used to convey parameter information as alpha or alphanumeric strings. For example, the :TIMEbase:MODE command can be set to normal, zoomed (delayed), XY, or ROLL. The character program data in this case may be MAIN, WINDow, XY, or ROLL. The command :TIMEbase:MODE WINDow sets the time base mode to zoomed.

The available mnemonics for character program data are always included with the command's syntax definition.

When sending commands, you may either the long form or short form (if one exists). Uppercase and lowercase letters may be mixed freely.

When receiving query responses, uppercase letters are used exclusively.

Numeric Program Data

Some command headers require program data to be expressed numerically. For example, :TIMEbase:RANGe requires the desired full scale range to be expressed numerically.

For numeric program data, you have the option of using exponential notation or using suffix multipliers to indicate the numeric value. The following numbers are all equal:

$$28 = 0.28E2 = 280e-1 = 28000m = 0.028K = 28e-3K.$$

When a syntax definition specifies that a number is an integer, that means that the number should be whole. Any fractional part will be ignored, truncating the number. Numeric data parameters accept fractional values are called real numbers.

All numbers must be strings of ASCII characters. Thus, when sending the number 9, you would send a byte representing the ASCII code for the character 9 (which is 57). A three-digit number like 102 would take up three bytes (ASCII codes 49, 48, and 50). This is handled automatically when you include the entire instruction in a string.

Duplicate Mnemonics

Identical function mnemonics can be used in more than one subsystem. For example, the function mnemonic RANGe may be used to change the vertical range or to change the horizontal range:

```
:CHANnel1:RANGe .4
```

Sets the vertical range of channel 1 to 0.4 volts full scale.

```
:TIMEbase:RANGe 1
```

Sets the horizontal time base to 1 second full scale.

:CHANnel1 and :TIMEbase are subsystem selectors and determine which range is being modified.

Tree Traversal Rules and Multiple Commands

Command headers are created by traversing down the command tree. A legal command header would be :TIMEbase:RANGe. This is referred to as a *compound header*. A compound header is a header made of two or more mnemonics separated by colons. The mnemonic created contains no spaces.

The following rules apply to traversing the tree:

- A leading colon (<NL> or EOI true on the last byte) places the parser at the root of the command tree. A leading colon is a colon that is the first character of a program header. Executing a subsystem command lets you access that subsystem until a leading colon or a program message terminator (<NL>) or EOI true is found.
- In the command tree, use the last mnemonic in the compound header as the reference point (for example, RANGe). Then find the last colon above that mnemonic (TIMEbase:). That is the point where the parser resides. Any command below that point can be sent within the current program message without sending the mnemonics which appear above them (for example, POSition).

The output statements in the examples are written using the Keysight VISA COM library in Visual Basic. The quoted string is placed on the bus, followed by a carriage return and linefeed (CRLF).

To execute more than one function within the same subsystem, separate the functions with a semicolon (;):

```
:<subsystem>:<function><separator><data>;<function><separator><data><terminator>
```

For example:

```
myScope.WriteString ":TIMEbase:RANGe 0.5;POSition 0"
```

NOTE

The colon between TIMEbase and RANGE is necessary because TIMEbase:RANGE is a compound command. The semicolon between the RANGE command and the POSition command is the required program message unit separator. The POSition command does not need TIMEbase preceding it because the TIMEbase:RANGE command sets the parser to the TIMEbase node in the tree.

Example 2:
Program Message Terminator Sets Parser Back to Root

```
myScope.WriteString ":TIMEbase:REfERENCE CENTER;POSition 0.00001"
or
myScope.WriteString ":TIMEbase:REfERENCE CENTER"
myScope.WriteString ":TIMEbase:POSition 0.00001"
```

NOTE

In the first line of example 2, the subsystem selector is implied for the POSition command in the compound command. The POSition command must be in the same program message as the REfERENCE command because the program message terminator places the parser back at the root of the command tree.

A second way to send these commands is by placing TIMEbase: before the POSition command as shown in the second part of example 2. The space after POSition is required.

Example 3:
Selecting Multiple Subsystems

You can send multiple program commands and program queries for different subsystems on the same line by separating each command with a semicolon. The colon following the semicolon enables you to enter a new subsystem. For example:

```
<program mnemonic><data>;:<program mnemonic><data><terminator>
```

For example:

```
myScope.WriteString ":TIMEbase:REfERENCE CENTER;:DISPlay:VECTors ON"
```

NOTE

The leading colon before DISPlay:VECTors ON tells the parser to go back to the root of the command tree. The parser can then see the DISPlay:VECTors ON command. The space between REfERENCE and CENTer is required; so is the space between VECTors and ON.

Multiple commands may be any combination of compound and simple commands.

Query Return Values

Command headers immediately followed by a question mark (?) are queries. Queries are used to get results of measurements made by the instrument or to find out how the instrument is currently configured.

After receiving a query, the instrument interrogates the requested function and places the answer in its output queue. The answer remains in the output queue until it is read or another command is issued.

When read, the answer is transmitted across the bus to the designated listener (typically a controller). For example, the query :TIMEbase:RANGe? places the current time base setting in the output queue. When using the Keysight VISA COM library in Visual Basic, the controller statements:

```
Dim strQueryResult As String
myScope.WriteString ":TIMEbase:RANGe?"
strQueryResult = myScope.ReadString
```

pass the value across the bus to the controller and place it in the variable strQueryResult.

NOTE

Read Query Results Before Sending Another Command. Sending another command or query before reading the result of a query clears the output buffer (the current response) and places a Query INTERRUPTED error in the error queue.

Infinity Representation	The representation of infinity is +9.9E+37. This is also the value returned when a measurement cannot be made.
--------------------------------	--

All Oscilloscope Commands Are Sequential

IEEE 488.2 makes the distinction between sequential and overlapped commands:

- *Sequential commands* finish their task before the execution of the next command starts.
- *Overlapped commands* run concurrently. Commands following an overlapped command may be started before the overlapped command is completed.

All of the oscilloscope commands are sequential.

42 Programming Examples

VISA COM Examples / 1394

VISA Examples / 1427

SICL Examples / 1480

SCPI.NET Examples / 1500

Example programs are ASCII text files that can be cut from the help file and pasted into your favorite text editor.

VISA COM Examples

- ["VISA COM Example in Visual Basic"](#) on page 1394
- ["VISA COM Example in C#"](#) on page 1403
- ["VISA COM Example in Visual Basic .NET"](#) on page 1412
- ["VISA COM Example in Python"](#) on page 1420

VISA COM Example in Visual Basic

To run this example in Visual Basic for Applications (VBA):

- 1 Start the application that provides Visual Basic for Applications (for example, Microsoft Excel).
- 2 Press ALT+F11 to launch the Visual Basic editor.
- 3 Reference the Keysight VISA COM library:
 - a Choose **Tools>References...** from the main menu.
 - b In the References dialog, check the "VISA COM 5.5 Type Library".
 - c Click **OK**.
- 4 Choose **Insert>Module**.
- 5 Cut-and-paste the code that follows into the editor.
- 6 Edit the program to use the VISA address of your oscilloscope, and save the changes.
- 7 Run the program.

```
'
' Keysight VISA COM Example in Visual Basic
' -----
' This program illustrates a few commonly-used programming
' features of your Keysight oscilloscope.
' -----

Option Explicit

Public myMgr As VisaComLib.ResourceManager
Public myScope As VisaComLib.FormattedIO488
Public varQueryResult As Variant
Public strQueryResult As String

' For Sleep subroutine.
Private Declare Sub Sleep Lib "kernel32" (ByVal dwMilliseconds As Long)

'
' Main Program
' -----

Sub Main()
```

```

On Error GoTo VisaComError

' Create the VISA COM I/O resource.
Set myMgr = New VisaComLib.ResourceManager
Set myScope = New VisaComLib.FormattedIO488
Set myScope.IO = _
    myMgr.Open("USB0::0x0957::0x17A6::US50210029::0::INSTR")
myScope.IO.Clear ' Clear the interface.
myScope.IO.Timeout = 10000 ' Set I/O communication timeout.

' Initialize - start from a known state.
Initialize

' Capture data.
Capture

' Analyze the captured waveform.
Analyze

Exit Sub

VisaComError:
MsgBox "VISA COM Error:" + vbCrLf + Err.Description
End

End Sub

'
' Initialize the oscilloscope to a known state.
' -----

Private Sub Initialize()

On Error GoTo VisaComError

' Get and display the device's *IDN? string.
strQueryResult = DoQueryString("*IDN?")
Debug.Print "Identification string: " + strQueryResult

' Clear status and load the default setup.
DoCommand "*CLS"
DoCommand "*RST"

Exit Sub

VisaComError:
MsgBox "VISA COM Error:" + vbCrLf + Err.Description
End

End Sub

'
' Capture the waveform.
' -----

Private Sub Capture()

```

```

On Error GoTo VisaComError

' Use auto-scale to automatically configure oscilloscope.
' -----
DoCommand ":AUToscale"

' Set trigger mode (EDGE, PULSe, PATtern, etc., and input source.
DoCommand ":TRIGger:MODE EDGE"
Debug.Print "Trigger mode: " + _
    DoQueryString(":TRIGger:MODE?")

' Set EDGE trigger parameters.
DoCommand ":TRIGger:EDGE:SOURce CHANnel1"
Debug.Print "Trigger edge source: " + _
    DoQueryString(":TRIGger:EDGE:SOURce?")

DoCommand ":TRIGger:EDGE:LEVel 1.5"
Debug.Print "Trigger edge level: " + _
    DoQueryString(":TRIGger:EDGE:LEVel?")

DoCommand ":TRIGger:EDGE:SLOPe POSitive"
Debug.Print "Trigger edge slope: " + _
    DoQueryString(":TRIGger:EDGE:SLOPe?")

' Save oscilloscope configuration.
' -----
varQueryResult = DoQueryIEEEBlock_UI1(":SYSTem:SETup?")

' Output setup string to a file:
Dim strPath As String
strPath = "c:\scope\config\setup.dat"
Dim hFile As Long
hFile = FreeFile
Open strPath For Binary Access Write Lock Write As hFile
Put hFile, , varQueryResult ' Write data.
Close hFile ' Close file.
Debug.Print "Setup bytes saved: " + CStr(LenB(varQueryResult))

' Change settings with individual commands:
' -----

' Set vertical scale and offset.
DoCommand ":CHANnel1:SCALe 0.05"
Debug.Print "Channel 1 vertical scale: " + _
    DoQueryString(":CHANnel1:SCALe?")

DoCommand ":CHANnel1:OFFSet -1.5"
Debug.Print "Channel 1 vertical offset: " + _
    DoQueryString(":CHANnel1:OFFSet?")

' Set horizontal scale and offset.
DoCommand ":TIMEbase:SCALe 0.0002"
Debug.Print "Timebase scale: " + _
    DoQueryString(":TIMEbase:SCALe?")

DoCommand ":TIMEbase:POSition 0.0"
Debug.Print "Timebase position: " + _

```

```

        DoQueryString(":TIMEbase:POSition?")

' Set the acquisition type (NORMAL, PEAK, AVERAGE, or HRESolution).
DoCommand ":ACQuire:TYPE NORMAL"
Debug.Print "Acquire type: " + _
    DoQueryString(":ACQuire:TYPE?")

' Or, configure by loading a previously saved setup.
' -----
Dim varSetupString As Variant
strPath = "c:\scope\config\setup.dat"
Open strPath For Binary Access Read As hFile ' Open file for input.
Get hFile, , varSetupString ' Read data.
Close hFile ' Close file.
' Write learn string back to oscilloscope using ":SYSTEM:SETup"
' command:
DoCommandIEEEBlock ":SYSTEM:SETup", varSetupString
Debug.Print "Setup bytes restored: " + CStr(LenB(varSetupString))

' Capture an acquisition using :DIGitize.
' -----
DoCommand ":DIGitize CHANnel1"

Exit Sub

VisaComError:
    MsgBox "VISA COM Error:" + vbCrLf + Err.Description
End

End Sub

'
' Analyze the captured waveform.
' -----

Private Sub Analyze()

    On Error GoTo VisaComError

' Make a couple of measurements.
' -----
DoCommand ":MEASure:SOURce CHANnel1"
Debug.Print "Measure source: " + _
    DoQueryString(":MEASure:SOURce?")

DoCommand ":MEASure:FREQuency"
varQueryResult = DoQueryNumber(":MEASure:FREQuency?")
MsgBox "Frequency:" + vbCrLf + _
    FormatNumber(varQueryResult / 1000, 4) + " kHz"

DoCommand ":MEASure:VAMPlitude"
varQueryResult = DoQueryNumber(":MEASure:VAMPlitude?")
MsgBox "Vertical amplitude:" + vbCrLf + _
    FormatNumber(varQueryResult, 4) + " V"

' Download the screen image.

```

```

' -----
' Get screen image.
DoCommand ":HARDcopy:INKSaver OFF"
Dim byteData() As Byte
byteData = DoQueryIEEEBlock_UI1(":DISPlay:DATA? PNG, COlor")

' Save screen image to a file.
Dim strPath As String
strPath = "c:\scope\data\screen.png"
If Len(Dir(strPath)) Then
    Kill strPath ' Remove file if it exists.
End If

Dim hFile As Long
hFile = FreeFile
Open strPath For Binary Access Write Lock Write As hFile
Put hFile, , byteData ' Write data.
Close hFile ' Close file.
MsgBox "Screen image (" + CStr(UBound(byteData) + 1) + _
    " bytes) written to " + strPath

' Download waveform data.
' -----

' Set the waveform points mode.
DoCommand ":WAVEform:POINts:MODE RAW"
Debug.Print "Waveform points mode: " + _
    DoQueryString(":WAVEform:POINts:MODE?")

' Get the number of waveform points available.
Debug.Print "Waveform points available: " + _
    DoQueryString(":WAVEform:POINts?")

' Set the waveform source.
DoCommand ":WAVEform:SOURce CHANnel1"
Debug.Print "Waveform source: " + _
    DoQueryString(":WAVEform:SOURce?")

' Choose the format of the data returned (WORD, BYTE, ASCII):
DoCommand ":WAVEform:FORMat BYTE"
Debug.Print "Waveform format: " + _
    DoQueryString(":WAVEform:FORMat?")

' Display the waveform settings:
Dim Preamble()
Dim intFormat As Integer
Dim intType As Integer
Dim lngPoints As Long
Dim lngCount As Long
Dim dblXIncrement As Double
Dim dblXOrigin As Double
Dim lngXReference As Long
Dim sngYIncrement As Single
Dim sngYOrigin As Single
Dim lngYReference As Long

```

```

Preamble() = DoQueryNumbers(":WAVEform:PREamble?")

intFormat = Preamble(0)
intType = Preamble(1)
lngPoints = Preamble(2)
lngCount = Preamble(3)
dblXIncrement = Preamble(4)
dblXOrigin = Preamble(5)
lngXReference = Preamble(6)
sngYIncrement = Preamble(7)
sngYOrigin = Preamble(8)
lngYReference = Preamble(9)

If intFormat = 0 Then
    Debug.Print "Waveform format: BYTE"
ElseIf intFormat = 1 Then
    Debug.Print "Waveform format: WORD"
ElseIf intFormat = 4 Then
    Debug.Print "Waveform format: ASCii"
End If

If intType = 0 Then
    Debug.Print "Acquisition type: NORMAl"
ElseIf intType = 1 Then
    Debug.Print "Acquisition type: PEAK"
ElseIf intType = 2 Then
    Debug.Print "Acquisition type: AVERAge"
ElseIf intType = 3 Then
    Debug.Print "Acquisition type: HRESolution"
End If

Debug.Print "Waveform points: " + _
    FormatNumber(lngPoints, 0)

Debug.Print "Waveform average count: " + _
    FormatNumber(lngCount, 0)

Debug.Print "Waveform X increment: " + _
    Format(dblXIncrement, "Scientific")

Debug.Print "Waveform X origin: " + _
    Format(dblXOrigin, "Scientific")

Debug.Print "Waveform X reference: " + _
    FormatNumber(lngXReference, 0)

Debug.Print "Waveform Y increment: " + _
    Format(sngYIncrement, "Scientific")

Debug.Print "Waveform Y origin: " + _
    FormatNumber(sngYOrigin, 0)

Debug.Print "Waveform Y reference: " + _
    FormatNumber(lngYReference, 0)

' Get the waveform data
varQueryResult = DoQueryIEEEBlock_UI1(":WAVEform:DATA?")

```

```

Debug.Print "Number of data values: " + _
    CStr(UBound(varQueryResult) + 1)

' Set up output file:
strPath = "c:\scope\data\waveform_data.csv"

' Open file for output.
Open strPath For Output Access Write Lock Write As hFile

' Output waveform data in CSV format.
Dim lngDataValue As Long
Dim lngI As Long

For lngI = 0 To UBound(varQueryResult)
    lngDataValue = varQueryResult(lngI)

    ' Write time value, voltage value.
    Print #hFile, _
        FormatNumber(dblXOrigin + (lngI * dblXIncrement), 9) + _
        ", " + _
        FormatNumber(((lngDataValue - lngYReference) * _
            sngYIncrement) + sngYOrigin)

Next lngI

' Close output file.
Close hFile ' Close file.
MsgBox "Waveform format BYTE data written to " + _
    "c:\scope\data\waveform_data.csv."

Exit Sub

VisaComError:
    MsgBox "VISA COM Error:" + vbCrLf + Err.Description
End

End Sub

Private Sub DoCommand(command As String)

    On Error GoTo VisaComError

    myScope.WriteString command
    CheckInstrumentErrors

Exit Sub

VisaComError:
    MsgBox "VISA COM Error: " + vbCrLf + CStr(Err.Number) + ", " + _
        Err.Source + ", " + _
        Err.Description, vbExclamation, "VISA COM Error"
End

End Sub

Private Sub DoCommandIEEEBlock(command As String, data As Variant)

```



```

On Error GoTo VisaComError

Dim strErrors As String

myScope.WriteIEEEBlock command, data
CheckInstrumentErrors

Exit Sub

VisaComError:
MsgBox "VISA COM Error: " + vbCrLf + CStr(Err.Number) + ", " + _
    Err.Source + ", " + _
    Err.Description, vbExclamation, "VISA COM Error"
End

End Sub

Private Function DoQueryString(query As String) As String

On Error GoTo VisaComError

myScope.WriteString query
DoQueryString = myScope.ReadString
CheckInstrumentErrors

Exit Function

VisaComError:
MsgBox "VISA COM Error: " + vbCrLf + CStr(Err.Number) + ", " + _
    Err.Source + ", " + _
    Err.Description, vbExclamation, "VISA COM Error"
End

End Function

Private Function DoQueryNumber(query As String) As Variant

On Error GoTo VisaComError

myScope.WriteString query
DoQueryNumber = myScope.ReadNumber
CheckInstrumentErrors

Exit Function

VisaComError:
MsgBox "VISA COM Error: " + vbCrLf + CStr(Err.Number) + ", " + _
    Err.Source + ", " + _
    Err.Description, vbExclamation, "VISA COM Error"
End

End Function

Private Function DoQueryNumbers(query As String) As Variant()

On Error GoTo VisaComError

```

```

Dim strErrors As String

myScope.WriteString query
DoQueryNumbers = myScope.ReadList
CheckInstrumentErrors

Exit Function

VisaComError:
MsgBox "VISA COM Error: " + vbCrLf + CStr(Err.Number) + ", " + _
    Err.Source + ", " + _
    Err.Description, vbExclamation, "VISA COM Error"
End

End Function

Private Function DoQueryIEEEBlock_UI1(query As String) As Variant

    On Error GoTo VisaComError

    myScope.WriteString query
    DoQueryIEEEBlock_UI1 = myScope.ReadIEEEBlock(BinaryType_UI1)
    CheckInstrumentErrors

    Exit Function

VisaComError:
MsgBox "VISA COM Error: " + vbCrLf + CStr(Err.Number) + ", " + _
    Err.Source + ", " + _
    Err.Description, vbExclamation, "VISA COM Error"
End

End Function

Private Sub CheckInstrumentErrors()

    On Error GoTo VisaComError

    Dim strErrVal As String
    Dim strOut As String

    myScope.WriteString ":SYSTem:ERror?" ' Query any errors data.
    strErrVal = myScope.ReadString ' Read: Errnum,"Error String".
    While Val(strErrVal) <> 0 ' End if find: 0,"No Error".
        strOut = strOut + "INST Error: " + strErrVal
        myScope.WriteString ":SYSTem:ERror?" ' Request error message.
        strErrVal = myScope.ReadString ' Read error message.
    Wend

    If Not strOut = "" Then
        MsgBox strOut, vbExclamation, "INST Error Messages"
        myScope.FlushWrite (False)
        myScope.FlushRead
    End If

Exit Sub

```

```

VisaComError:
    MsgBox "VISA COM Error: " + vbCrLf + Err.Description

End Sub

```

VISA COM Example in C#

To compile and run this example in Microsoft Visual Studio 2008:

- 1 Open Visual Studio.
- 2 Create a new Visual C#, Windows, Console Application project.
- 3 Cut-and-paste the code that follows into the C# source file.
- 4 Edit the program to use the VISA address of your oscilloscope.
- 5 Add a reference to the VISA COM 5.5 Type Library:
 - a Right-click the project you wish to modify (not the solution) in the Solution Explorer window of the Microsoft Visual Studio environment.
 - b Choose **Add Reference...**
 - c In the Add Reference dialog, select the **COM** tab.
 - d Select **VISA COM 5.5 Type Library**; then click **OK**.
- 6 Build and run the program.

For more information, see the VISA COM Help that comes with Keysight IO Libraries Suite 16.

```

/*
 * Keysight VISA COM Example in C#
 * -----
 * This program illustrates a few commonly used programming
 * features of your Keysight oscilloscope.
 * -----
 */

using System;
using System.IO;
using System.Text;
using Ivi.Visa.Interop;
using System.Runtime.InteropServices;

namespace InfiniiVision
{
    class VisaComInstrumentApp
    {
        private static VisaComInstrument myScope;

        public static void Main(string[] args)
        {
            try
            {
                myScope = new

```

```

        VisaComInstrument("USB0::0x0957::0x17A6::US50210029::0::INSTR"
);
myScope.SetTimeoutSeconds(10);

// Initialize - start from a known state.
Initialize();

// Capture data.
Capture();

// Analyze the captured waveform.
Analyze();
}
catch (System.ApplicationException err)
{
    Console.WriteLine("*** VISA COM Error : " + err.Message);
}
catch (System.SystemException err)
{
    Console.WriteLine("*** System Error Message : " + err.Message);
}
catch (System.Exception err)
{
    System.Diagnostics.Debug.Fail("Unexpected Error");
    Console.WriteLine("*** Unexpected Error : " + err.Message);
}
finally
{
    myScope.Close();
}
}

/*
 * Initialize the oscilloscope to a known state.
 * -----
 */
private static void Initialize()
{
    string strResults;

    // Get and display the device's *IDN? string.
    strResults = myScope.DoQueryString("*IDN?");
    Console.WriteLine("*IDN? result is: {0}", strResults);

    // Clear status and load the default setup.
    myScope.DoCommand("*CLS");
    myScope.DoCommand("*RST");
}

/*
 * Capture the waveform.
 * -----
 */
private static void Capture()
{
    // Use auto-scale to automatically configure oscilloscope.
    myScope.DoCommand(":AUToscale");
}

```

```

// Set trigger mode (EDGE, PULSe, PATTeRn, etc., and input source.
myScope.DoCommand(":TRIGger:MODE EDGE");
Console.WriteLine("Trigger mode: {0}",
    myScope.DoQueryString(":TRIGger:MODE?"));

// Set EDGE trigger parameters.
myScope.DoCommand(":TRIGger:EDGE:SOURce CHANnel1");
Console.WriteLine("Trigger edge source: {0}",
    myScope.DoQueryString(":TRIGger:EDGE:SOURce?"));

myScope.DoCommand(":TRIGger:EDGE:LEVel 1.5");
Console.WriteLine("Trigger edge level: {0}",
    myScope.DoQueryString(":TRIGger:EDGE:LEVel?"));

myScope.DoCommand(":TRIGger:EDGE:SLOPe POSitive");
Console.WriteLine("Trigger edge slope: {0}",
    myScope.DoQueryString(":TRIGger:EDGE:SLOPe?"));

// Save oscilloscope configuration.
byte[] ResultsArray; // Results array.
int nLength; // Number of bytes returned from instrument.
string strPath;

// Query and read setup string.
ResultsArray = myScope.DoQueryIEEEBlock(":SYSTem:SETup?");
nLength = ResultsArray.Length;

// Write setup string to file.
strPath = "c:\\scope\\config\\setup.stp";
FileStream fStream = File.Open(strPath, FileMode.Create);
fStream.Write(ResultsArray, 0, nLength);
fStream.Close();
Console.WriteLine("Setup bytes saved: {0}", nLength);

// Change settings with individual commands:

// Set vertical scale and offset.
myScope.DoCommand(":CHANnel1:SCALe 0.05");
Console.WriteLine("Channel 1 vertical scale: {0}",
    myScope.DoQueryString(":CHANnel1:SCALe?"));

myScope.DoCommand(":CHANnel1:OFFSet -1.5");
Console.WriteLine("Channel 1 vertical offset: {0}",
    myScope.DoQueryString(":CHANnel1:OFFSet?"));

// Set horizontal scale and offset.
myScope.DoCommand(":TIMebase:SCALe 0.0002");
Console.WriteLine("Timebase scale: {0}",
    myScope.DoQueryString(":TIMebase:SCALe?"));

myScope.DoCommand(":TIMebase:POSition 0.0");
Console.WriteLine("Timebase position: {0}",
    myScope.DoQueryString(":TIMebase:POSition?"));

// Set the acquisition type (NORMal, PEAK, AVERage, or HRESolution
).

```

```

myScope.DoCommand(":ACquire:TYPE NORMal");
Console.WriteLine("Acquire type: {0}",
    myScope.DoQueryString(":ACquire:TYPE?"));

// Or, configure by loading a previously saved setup.
byte[] dataArray;
int nBytesWritten;

// Read setup string from file.
strPath = "c:\\scope\\config\\setup.stp";
dataArray = File.ReadAllBytes(strPath);
nBytesWritten = dataArray.Length;

// Restore setup string.
myScope.DoCommandIIEEEBlock(":SYSTem:SETup", dataArray);
Console.WriteLine("Setup bytes restored: {0}", nBytesWritten);

// Capture an acquisition using :DIGitize.
myScope.DoCommand(":DIGitize CHANnel1");
}

/*
 * Analyze the captured waveform.
 * -----
 */
private static void Analyze()
{
    byte[] resultsArray; // Results array.
    int nLength; // Number of bytes returned from instrument.
    string strPath;

    // Make a couple of measurements.
    // -----
    myScope.DoCommand(":MEASure:SOURce CHANnel1");
    Console.WriteLine("Measure source: {0}",
        myScope.DoQueryString(":MEASure:SOURce?"));

    double fResult;
    myScope.DoCommand(":MEASure:FREQuency");
    fResult = myScope.DoQueryNumber(":MEASure:FREQuency?");
    Console.WriteLine("Frequency: {0:F4} kHz", fResult / 1000);

    myScope.DoCommand(":MEASure:VAMplitude");
    fResult = myScope.DoQueryNumber(":MEASure:VAMplitude?");
    Console.WriteLine("Vertical amplitude: {0:F2} V", fResult);

    // Download the screen image.
    // -----
    myScope.DoCommand(":HARDcopy:INKSaver OFF");

    // Get the screen data.
    resultsArray =
        myScope.DoQueryIIEEEBlock(":DISPlay:DATA? PNG, COLor");
    nLength = resultsArray.Length;

    // Store the screen data to a file.
    strPath = "c:\\scope\\data\\screen.png";
}

```

```

FileStream fStream = File.Open(strPath, FileMode.Create);
fStream.Write(ResultsArray, 0, nLength);
fStream.Close();
Console.WriteLine("Screen image ({0} bytes) written to {1}",
    nLength, strPath);

// Download waveform data.
// -----

// Set the waveform points mode.
myScope.DoCommand(":WAVEform:POINTs:MODE RAW");
Console.WriteLine("Waveform points mode: {0}",
    myScope.DoQueryString(":WAVEform:POINTs:MODE?"));

// Get the number of waveform points available.
Console.WriteLine("Waveform points available: {0}",
    myScope.DoQueryString(":WAVEform:POINTs?"));

// Set the waveform source.
myScope.DoCommand(":WAVEform:SOURce CHANnel1");
Console.WriteLine("Waveform source: {0}",
    myScope.DoQueryString(":WAVEform:SOURce?"));

// Choose the format of the data returned (WORD, BYTE, ASCII):
myScope.DoCommand(":WAVEform:FORMat BYTE");
Console.WriteLine("Waveform format: {0}",
    myScope.DoQueryString(":WAVEform:FORMat?"));

// Display the waveform settings:
double[] fResultsArray;
fResultsArray = myScope.DoQueryNumbers(":WAVEform:PREAmble?");

double fFormat = fResultsArray[0];
if (fFormat == 0.0)
{
    Console.WriteLine("Waveform format: BYTE");
}
else if (fFormat == 1.0)
{
    Console.WriteLine("Waveform format: WORD");
}
else if (fFormat == 2.0)
{
    Console.WriteLine("Waveform format: ASCii");
}

double fType = fResultsArray[1];
if (fType == 0.0)
{
    Console.WriteLine("Acquire type: NORMAl");
}
else if (fType == 1.0)
{
    Console.WriteLine("Acquire type: PEAK");
}
else if (fType == 2.0)
{

```

```

        Console.WriteLine("Acquire type: AVERage");
    }
    else if (fType == 3.0)
    {
        Console.WriteLine("Acquire type: HRESolution");
    }

    double fPoints = fResultsArray[2];
    Console.WriteLine("Waveform points: {0:e}", fPoints);

    double fCount = fResultsArray[3];
    Console.WriteLine("Waveform average count: {0:e}", fCount);

    double fXincrement = fResultsArray[4];
    Console.WriteLine("Waveform X increment: {0:e}", fXincrement);

    double fXorigin = fResultsArray[5];
    Console.WriteLine("Waveform X origin: {0:e}", fXorigin);

    double fXreference = fResultsArray[6];
    Console.WriteLine("Waveform X reference: {0:e}", fXreference);

    double fYincrement = fResultsArray[7];
    Console.WriteLine("Waveform Y increment: {0:e}", fYincrement);

    double fYorigin = fResultsArray[8];
    Console.WriteLine("Waveform Y origin: {0:e}", fYorigin);

    double fYreference = fResultsArray[9];
    Console.WriteLine("Waveform Y reference: {0:e}", fYreference);

    // Read waveform data.
    ResultsArray = myScope.DoQueryIEEEBlock(":WAVEform:DATA?");
    nLength = ResultsArray.Length;
    Console.WriteLine("Number of data values: {0}", nLength);

    // Set up output file:
    strPath = "c:\\scope\\data\\waveform_data.csv";
    if (File.Exists(strPath)) File.Delete(strPath);

    // Open file for output.
    StreamWriter writer = File.CreateText(strPath);

    // Output waveform data in CSV format.
    for (int i = 0; i < nLength - 1; i++)
        writer.WriteLine("{0:f9}, {1:f6}",
            fXorigin + ((float)i * fXincrement),
            (((float)ResultsArray[i] - fYreference)
            * fYincrement) + fYorigin);

    // Close output file.
    writer.Close();
    Console.WriteLine("Waveform format BYTE data written to {0}",
        strPath);
}
}

```



```

class VisaComInstrument
{
    private ResourceManagerClass m_ResourceManager;
    private FormattedIO488Class m_IoObject;
    private string m_strVisaAddress;

    // Constructor.
    public VisaComInstrument(string strVisaAddress)
    {
        // Save VISA address in member variable.
        m_strVisaAddress = strVisaAddress;

        // Open the default VISA COM IO object.
        OpenIo();

        // Clear the interface.
        m_IoObject.IO.Clear();
    }

    public void DoCommand(string strCommand)
    {
        // Send the command.
        m_IoObject.WriteString(strCommand, true);

        // Check for inst errors.
        CheckInstrumentErrors(strCommand);
    }

    public void DoCommandIEEEBlock(string strCommand,
        byte[] dataArray)
    {
        // Send the command to the device.
        m_IoObject.WriteIEEEBlock(strCommand, dataArray, true);

        // Check for inst errors.
        CheckInstrumentErrors(strCommand);
    }

    public string DoQueryString(string strQuery)
    {
        // Send the query.
        m_IoObject.WriteString(strQuery, true);

        // Get the result string.
        string strResults;
        strResults = m_IoObject.ReadString();

        // Check for inst errors.
        CheckInstrumentErrors(strQuery);

        // Return results string.
        return strResults;
    }

    public double DoQueryNumber(string strQuery)
    {
        // Send the query.

```

```

    m_IoObject.WriteString(strQuery, true);

    // Get the result number.
    double fResult;
    fResult = (double)m_IoObject.ReadNumber(
        IEEEASCIIType.ASCIIType_R8, true);

    // Check for inst errors.
    CheckInstrumentErrors(strQuery);

    // Return result number.
    return fResult;
}

public double[] DoQueryNumbers(string strQuery)
{
    // Send the query.
    m_IoObject.WriteString(strQuery, true);

    // Get the result numbers.
    double[] fResultsArray;
    fResultsArray = (double[])m_IoObject.ReadList(
        IEEEASCIIType.ASCIIType_R8, ",;");

    // Check for inst errors.
    CheckInstrumentErrors(strQuery);

    // Return result numbers.
    return fResultsArray;
}

public byte[] DoQueryIEEEBlock(string strQuery)
{
    // Send the query.
    m_IoObject.WriteString(strQuery, true);

    // Get the results array.
    System.Threading.Thread.Sleep(2000); // Delay before reading.
    byte[] ResultsArray;
    ResultsArray = (byte[])m_IoObject.ReadIEEEBlock(
        IEEEBinaryType.BinaryType_UI1, false, true);

    // Check for inst errors.
    CheckInstrumentErrors(strQuery);

    // Return results array.
    return ResultsArray;
}

private void CheckInstrumentErrors(string strCommand)
{
    // Check for instrument errors.
    string strInstrumentError;
    bool bFirstError = true;

    do // While not "0,No error".
    {

```

```

        m_IoObject.WriteString(":SYSTEM:ERRor?", true);
        strInstrumentError = m_IoObject.ReadString();

        if (!strInstrumentError.ToString().StartsWith("+0, "))
        {
            if (bFirstError)
            {
                Console.WriteLine("ERROR(s) for command '{0}': ",
                    strCommand);
                bFirstError = false;
            }
            Console.Write(strInstrumentError);
        }
    } while (!strInstrumentError.ToString().StartsWith("+0, "));
}

private void OpenIo()
{
    m_ResourceManager = new ResourceManagerClass();
    m_IoObject = new FormattedIO488Class();

    // Open the default VISA COM IO object.
    try
    {
        m_IoObject.IO =
            (IMessage)m_ResourceManager.Open(m_strVisaAddress,
                AccessMode.NO_LOCK, 0, "");
    }
    catch (Exception e)
    {
        Console.WriteLine("An error occurred: {0}", e.Message);
    }
}

public void SetTimeoutSeconds(int nSeconds)
{
    m_IoObject.IO.Timeout = nSeconds * 1000;
}

public void Close()
{
    try
    {
        m_IoObject.IO.Close();
    }
    catch { }

    try
    {
        Marshal.ReleaseComObject(m_IoObject);
    }
    catch { }

    try
    {
        Marshal.ReleaseComObject(m_ResourceManager);
    }
}

```

```

        catch { }
    }
}

```

VISA COM Example in Visual Basic .NET

To compile and run this example in Microsoft Visual Studio 2008:

- 1 Open Visual Studio.
- 2 Create a new Visual Basic, Windows, Console Application project.
- 3 Cut-and-paste the code that follows into the C# source file.
- 4 Edit the program to use the VISA address of your oscilloscope.
- 5 Add a reference to the VISA COM 5.5 Type Library:
 - a Right-click the project you wish to modify (not the solution) in the Solution Explorer window of the Microsoft Visual Studio environment.
 - b Choose **Add Reference...**
 - c In the Add Reference dialog, select the **COM** tab.
 - d Select **VISA COM 5.5 Type Library**; then click **OK**.
 - e Right-click the project you wish to modify (not the solution) in the Solution Explorer window of the Microsoft Visual Studio environment and choose **Properties**; then, select "InfiniiVision.VisaComInstrumentApp" as the **Startup object**.
- 6 Build and run the program.

For more information, see the VISA COM Help that comes with Keysight IO Libraries Suite 16.

```

'
' Keysight VISA COM Example in Visual Basic .NET
' -----
' This program illustrates a few commonly used programming
' features of your Keysight oscilloscope.
' -----

Imports System
Imports System.IO
Imports System.Text
Imports Ivi.Visa.Interop
Imports System.Runtime.InteropServices

Namespace InfiniiVision
    Class VisaComInstrumentApp
        Private Shared myScope As VisaComInstrument

        Public Shared Sub Main(ByVal args As String())
            Try
                myScope = New _
                    VisaComInstrument("USB0::0x0957::0x17A6::US50210029::0::INSTR")
            Catch ex As Exception
                Console.WriteLine(ex.Message)
            End Try
        End Sub
    End Class
End Namespace

```

```

)
    myScope.SetTimeoutSeconds(10)

    ' Initialize - start from a known state.
    Initialize()

    ' Capture data.
    Capture()

    ' Analyze the captured waveform.
    Analyze()

Catch err As System.ApplicationException
    Console.WriteLine("*** VISA Error Message : " + err.Message)
Catch err As System.SystemException
    Console.WriteLine("*** System Error Message : " + err.Message)
Catch err As System.Exception
    System.Diagnostics.Debug.Fail("Unexpected Error")
    Console.WriteLine("*** Unexpected Error : " + err.Message)
Finally
    myScope.Close()
End Try
End Sub

' Initialize the oscilloscope to a known state.
' -----

Private Shared Sub Initialize()
    Dim strResults As String

    ' Get and display the device's *IDN? string.
    strResults = myScope.DoQueryString("*IDN?")
    Console.WriteLine("*IDN? result is: {0}", strResults)

    ' Clear status and load the default setup.
    myScope.DoCommand("*CLS")
    myScope.DoCommand("*RST")

End Sub

' Capture the waveform.
' -----

Private Shared Sub Capture()

    ' Use auto-scale to automatically configure oscilloscope.
    myScope.DoCommand(":AUToscale")

    ' Set trigger mode (EDGE, PULSe, PATtern, etc., and input source.
    myScope.DoCommand(":TRIGger:MODE EDGE")
    Console.WriteLine("Trigger mode: {0}", _
        myScope.DoQueryString(":TRIGger:MODE?"))

    ' Set EDGE trigger parameters.
    myScope.DoCommand(":TRIGger:EDGE:SOURce CHANnel1")
    Console.WriteLine("Trigger edge source: {0}", _
        myScope.DoQueryString(":TRIGger:EDGE:SOURce?"))

```

```

myScope.DoCommand(":TRIGger:EDGE:LEVel 1.5")
Console.WriteLine("Trigger edge level: {0}", _
    myScope.DoQueryString(":TRIGger:EDGE:LEVel?"))

myScope.DoCommand(":TRIGger:EDGE:SLOPe POSitive")
Console.WriteLine("Trigger edge slope: {0}", _
    myScope.DoQueryString(":TRIGger:EDGE:SLOPe?"))

' Save oscilloscope configuration.
Dim ResultsArray As Byte() ' Results array.
Dim nLength As Integer ' Number of bytes returned from inst.
Dim strPath As String
Dim fStream As FileStream

' Query and read setup string.
ResultsArray = myScope.DoQueryIEEEBlock(":SYSTem:SETup?")
nLength = ResultsArray.Length

' Write setup string to file.
strPath = "c:\scope\config\setup.stp"
fStream = File.Open(strPath, FileMode.Create)
fStream.Write(ResultsArray, 0, nLength)
fStream.Close()
Console.WriteLine("Setup bytes saved: {0}", nLength)

' Change settings with individual commands:

' Set vertical scale and offset.
myScope.DoCommand(":CHANnel1:SCALe 0.05")
Console.WriteLine("Channel 1 vertical scale: {0}", _
    myScope.DoQueryString(":CHANnel1:SCALe?"))

myScope.DoCommand(":CHANnel1:OFFSet -1.5")
Console.WriteLine("Channel 1 vertical offset: {0}", _
    myScope.DoQueryString(":CHANnel1:OFFSet?"))

' Set horizontal scale and offset.
myScope.DoCommand(":TIMebase:SCALe 0.0002")
Console.WriteLine("Timebase scale: {0}", _
    myScope.DoQueryString(":TIMebase:SCALe?"))

myScope.DoCommand(":TIMebase:POSition 0.0")
Console.WriteLine("Timebase position: {0}", _
    myScope.DoQueryString(":TIMebase:POSition?"))

' Set the acquisition type (NORMal, PEAK, AVERAge, or HRESolution)

myScope.DoCommand(":ACQuire:TYPE NORMal")
Console.WriteLine("Acquire type: {0}", _
    myScope.DoQueryString(":ACQuire:TYPE?"))

' Or, configure by loading a previously saved setup.
Dim dataArray As Byte()
Dim nBytesWritten As Integer

' Read setup string from file.

```

```

strPath = "c:\scope\config\setup.stp"
dataArray = File.ReadAllBytes(strPath)
nBytesWritten = dataArray.Length

' Restore setup string.
myScope.DoCommandIEEEBlock(":SYSTEM:SETup", dataArray)
Console.WriteLine("Setup bytes restored: {0}", nBytesWritten)

' Capture an acquisition using :DIGitize.
myScope.DoCommand(":DIGitize CHANnel1")

End Sub

' Analyze the captured waveform.
' -----

Private Shared Sub Analyze()

    Dim fResult As Double
    Dim ResultsArray As Byte() ' Results array.
    Dim nLength As Integer ' Number of bytes returned from inst.
    Dim strPath As String

    ' Make a couple of measurements.
    ' -----
    myScope.DoCommand(":MEASure:SOURce CHANnel1")
    Console.WriteLine("Measure source: {0}", _
        myScope.DoQueryString(":MEASure:SOURce?"))

    myScope.DoCommand(":MEASure:FREQuency")
    fResult = myScope.DoQueryNumber(":MEASure:FREQuency?")
    Console.WriteLine("Frequency: {0:F4} kHz", fResult / 1000)

    myScope.DoCommand(":MEASure:VAMPlitude")
    fResult = myScope.DoQueryNumber(":MEASure:VAMPlitude?")
    Console.WriteLine("Vertical amplitude: {0:F2} V", fResult)

    ' Download the screen image.
    ' -----
    myScope.DoCommand(":HARDcopy:INKSaver OFF")

    ' Get the screen data.
    ResultsArray = myScope.DoQueryIEEEBlock(":DISPlay:DATA? PNG, COLor
")
    nLength = ResultsArray.Length

    ' Store the screen data to a file.
    strPath = "c:\scope\data\screen.png"
    Dim fStream As FileStream
    fStream = File.Open(strPath, FileMode.Create)
    fStream.Write(ResultsArray, 0, nLength)
    fStream.Close()
    Console.WriteLine("Screen image ({0} bytes) written to {1}", _
        nLength, strPath)

    ' Download waveform data.
    ' -----

```

```

' Set the waveform points mode.
myScope.DoCommand(":WAVEform:POINTs:MODE RAW")
Console.WriteLine("Waveform points mode: {0}", _
    myScope.DoQueryString(":WAVEform:POINTs:MODE?"))

' Get the number of waveform points available.
Console.WriteLine("Waveform points available: {0}", _
    myScope.DoQueryString(":WAVEform:POINTs?"))

' Set the waveform source.
myScope.DoCommand(":WAVEform:SOURce CHANnel")
Console.WriteLine("Waveform source: {0}", _
    myScope.DoQueryString(":WAVEform:SOURce?"))

' Choose the format of the data returned (WORD, BYTE, ASCII):
myScope.DoCommand(":WAVEform:FORMat BYTE")
Console.WriteLine("Waveform format: {0}", _
    myScope.DoQueryString(":WAVEform:FORMat?"))

' Display the waveform settings:
Dim fResultsArray As Double()
fResultsArray = myScope.DoQueryNumbers(":WAVEform:PREamble?")

Dim fFormat As Double = fResultsArray(0)
If fFormat = 0 Then
    Console.WriteLine("Waveform format: BYTE")
ElseIf fFormat = 1 Then
    Console.WriteLine("Waveform format: WORD")
ElseIf fFormat = 2 Then
    Console.WriteLine("Waveform format: ASCii")
End If

Dim fType As Double = fResultsArray(1)
If fType = 0 Then
    Console.WriteLine("Acquire type: NORMAl")
ElseIf fType = 1 Then
    Console.WriteLine("Acquire type: PEAK")
ElseIf fType = 2 Then
    Console.WriteLine("Acquire type: AVERAge")
ElseIf fType = 3 Then
    Console.WriteLine("Acquire type: HRESolution")
End If

Dim fPoints As Double = fResultsArray(2)
Console.WriteLine("Waveform points: {0:e}", fPoints)

Dim fCount As Double = fResultsArray(3)
Console.WriteLine("Waveform average count: {0:e}", fCount)

Dim fXincrement As Double = fResultsArray(4)
Console.WriteLine("Waveform X increment: {0:e}", fXincrement)

Dim fXorigin As Double = fResultsArray(5)
Console.WriteLine("Waveform X origin: {0:e}", fXorigin)

Dim fXreference As Double = fResultsArray(6)

```



```

Console.WriteLine("Waveform X reference: {0:e}", fXreference)

Dim fYincrement As Double = fResultsArray(7)
Console.WriteLine("Waveform Y increment: {0:e}", fYincrement)

Dim fYorigin As Double = fResultsArray(8)
Console.WriteLine("Waveform Y origin: {0:e}", fYorigin)

Dim fYreference As Double = fResultsArray(9)
Console.WriteLine("Waveform Y reference: {0:e}", fYreference)

' Get the waveform data.
ResultsArray = myScope.DoQueryIEEEBlock(":WAVEform:DATA?")
nLength = ResultsArray.Length
Console.WriteLine("Number of data values: {0}", nLength)

' Set up output file:
strPath = "c:\scope\data\waveform_data.csv"
If File.Exists(strPath) Then
    File.Delete(strPath)
End If

' Open file for output.
Dim writer As StreamWriter = File.CreateText(strPath)

' Output waveform data in CSV format.
For index As Integer = 0 To nLength - 1
    ' Write time value, voltage value.
    writer.WriteLine("{0:f9}, {1:f6}", _
        fXorigin + (CSng(index) * fXincrement), _
        ((CSng(ResultsArray(index)) - fYreference) _
        * fYincrement) + fYorigin)
Next

' Close output file.
writer.Close()
Console.WriteLine("Waveform format BYTE data written to {0}", _
    strPath)

End Sub

End Class

Class VisaComInstrument
Private m_ResourceManager As ResourceManagerClass
Private m_IOException As FormattedIO488Class
Private m_strVisaAddress As String

' Constructor.
Public Sub New(ByVal strVisaAddress As String)

    ' Save VISA address in member variable.
    m_strVisaAddress = strVisaAddress

    ' Open the default VISA COM IO object.
    OpenIo()

```

```

    ' Clear the interface.
    m_IoObject.IO.Clear()

End Sub

Public Sub DoCommand(ByVal strCommand As String)

    ' Send the command.
    m_IoObject.WriteString(strCommand, True)

    ' Check for inst errors.
    CheckInstrumentErrors(strCommand)

End Sub

Public Sub DoCommandIEEEBlock(ByVal strCommand As String, _
    ByVal dataArray As Byte())

    ' Send the command to the device.
    m_IoObject.WriteIEEEBlock(strCommand, dataArray, True)

    ' Check for inst errors.
    CheckInstrumentErrors(strCommand)

End Sub

Public Function DoQueryString(ByVal strQuery As String) As String
    ' Send the query.
    m_IoObject.WriteString(strQuery, True)

    ' Get the result string.
    Dim strResults As String
    strResults = m_IoObject.ReadString()

    ' Check for inst errors.
    CheckInstrumentErrors(strQuery)

    ' Return results string.
    Return strResults
End Function

Public Function DoQueryNumber(ByVal strQuery As String) As Double
    ' Send the query.
    m_IoObject.WriteString(strQuery, True)

    ' Get the result number.
    Dim fResult As Double
    fResult = _
        CDb1(m_IoObject.ReadNumber(IEEEASCIIType.ASCIIType_R8, True))

    ' Check for inst errors.
    CheckInstrumentErrors(strQuery)

    ' Return result number.
    Return fResult
End Function

```

```

Public Function DoQueryNumbers(ByVal strQuery As String) As _
    Double()
    ' Send the query.
    m_IoObject.WriteString(strQuery, True)

    ' Get the result numbers.
    Dim fResultsArray As Double()
    fResultsArray = _
        m_IoObject.ReadList(IEEEASCIIType.ASCIIType_R8, ",;")

    ' Check for inst errors.
    CheckInstrumentErrors(strQuery)

    ' Return result numbers.
    Return fResultsArray
End Function

Public _
    Function DoQueryIEEEBlock(ByVal strQuery As String) As Byte()
    ' Send the query.
    m_IoObject.WriteString(strQuery, True)

    ' Get the results array.
    System.Threading.Thread.Sleep(2000) ' Delay before reading data.
    Dim ResultsArray As Byte()
    ResultsArray = _
        m_IoObject.ReadIEEEBlock(IEEEBinaryType.BinaryType_UI1, _
            False, True)

    ' Check for inst errors.
    CheckInstrumentErrors(strQuery)

    ' Return results array.
    Return ResultsArray
End Function

Private Sub CheckInstrumentErrors(ByVal strCommand As String)
    ' Check for instrument errors.
    Dim strInstrumentError As String
    Dim bFirstError As Boolean = True
    Do ' While not "0,No error".
        m_IoObject.WriteString(":SYSTem:ERRor?", True)
        strInstrumentError = m_IoObject.ReadString()

        If Not strInstrumentError.ToString().StartsWith("+0,") Then
            If bFirstError Then
                Console.WriteLine("ERROR(s) for command '{0}': ", _
                    strCommand)
                bFirstError = False
            End If
            Console.Write(strInstrumentError)
        End If
    Loop While Not strInstrumentError.ToString().StartsWith("+0,")
End Sub

Private Sub OpenIo()
    m_ResourceManager = New ResourceManagerClass()

```

```

    m_IoObject = New FormattedIO488Class()

    ' Open the default VISA COM IO object.
    Try
        m_IoObject.IO = _
            DirectCast(m_ResourceManager.Open(m_strVisaAddress, _
                AccessMode.NO_LOCK, 0, ""), IMessage)
    Catch e As Exception
        Console.WriteLine("An error occurred: {0}", e.Message)
    End Try
End Sub

Public Sub SetTimeoutSeconds(ByVal nSeconds As Integer)
    m_IoObject.IO.Timeout = nSeconds * 1000
End Sub

Public Sub Close()
    Try
        m_IoObject.IO.Close()
    Catch
    End Try

    Try
        Marshal.ReleaseComObject(m_IoObject)
    Catch
    End Try

    Try
        Marshal.ReleaseComObject(m_ResourceManager)
    Catch
    End Try
End Sub
End Class
End Namespace

```

VISA COM Example in Python

You can use the Python programming language with the "comtypes" package to control Keysight oscilloscopes.

The Python language and "comtypes" package can be downloaded from the web at <http://www.python.org/> and <http://starship.python.net/crew/theller/comtypes/>, respectively.

To run this example with Python and "comtypes":

- 1 Cut-and-paste the code that follows into a file named "example.py".
- 2 Edit the program to use the VISA address of your oscilloscope.
- 3 If "python.exe" can be found via your PATH environment variable, open a Command Prompt window; then, change to the folder that contains the "example.py" file, and enter:

```
python example.py
```

```

#
# Keysight VISA COM Example in Python using "comtypes"
# *****
# This program illustrates a few commonly used programming
# features of your Keysight oscilloscope.
# *****

# Import Python modules.
# -----
import string
import time
import sys
import array

from comtypes.client import GetModule
from comtypes.client import CreateObject

# Run GetModule once to generate comtypes.gen.VisaComLib.
if not hasattr(sys, "frozen"):
    GetModule("C:\Program Files (x86)\IVI Foundation\VISA\VisaCom\
GlobMgr.dll")

import comtypes.gen.VisaComLib as VisaComLib

# Global variables (booleans: 0 = False, 1 = True).
# -----

# =====
# Initialize:
# =====
def initialize():
    # Get and display the device's *IDN? string.
    idn_string = do_query_string("*IDN?")
    print "Identification string '%s'" % idn_string

    # Clear status and load the default setup.
    do_command("*CLS")
    do_command("*RST")

# =====
# Capture:
# =====
def capture():

    # Use auto-scale to automatically set up oscilloscope.
    print "Autoscale."
    do_command(":AUToscale")

    # Set trigger mode.
    do_command(":TRIGger:MODE EDGE")
    qresult = do_query_string(":TRIGger:MODE?")
    print "Trigger mode: %s" % qresult

    # Set EDGE trigger parameters.

```

```

do_command(":TRIGger:EDGE:SOURce CHANnel1")
qresult = do_query_string(":TRIGger:EDGE:SOURce?")
print "Trigger edge source: %s" % qresult

do_command(":TRIGger:EDGE:LEVel 1.5")
qresult = do_query_string(":TRIGger:EDGE:LEVel?")
print "Trigger edge level: %s" % qresult

do_command(":TRIGger:EDGE:SLOPe POSitive")
qresult = do_query_string(":TRIGger:EDGE:SLOPe?")
print "Trigger edge slope: %s" % qresult

# Save oscilloscope setup.
setup_bytes = do_query_ieee_block(":SYSTem:SETUp?")
nLength = len(setup_bytes)
f = open("c:\scope\config\setup.stp", "wb")
f.write(bytearray(setup_bytes))
f.close()
print "Setup bytes saved: %d" % nLength

# Change oscilloscope settings with individual commands:

# Set vertical scale and offset.
do_command(":CHANnel1:SCALe 0.05")
qresult = do_query_number(":CHANnel1:SCALe?")
print "Channel 1 vertical scale: %f" % qresult

do_command(":CHANnel1:OFFSet -1.5")
qresult = do_query_number(":CHANnel1:OFFSet?")
print "Channel 1 offset: %f" % qresult

# Set horizontal scale and offset.
do_command(":TIMEbase:SCALe 0.0002")
qresult = do_query_string(":TIMEbase:SCALe?")
print "Timebase scale: %s" % qresult

do_command(":TIMEbase:POSition 0.0")
qresult = do_query_string(":TIMEbase:POSition?")
print "Timebase position: %s" % qresult

# Set the acquisition type.
do_command(":ACQuire:TYPE NORMal")
qresult = do_query_string(":ACQuire:TYPE?")
print "Acquire type: %s" % qresult

# Or, configure by loading a previously saved setup.
f = open("c:\scope\config\setup.stp", "rb")
setup_bytes = f.read()
f.close()
do_command_ieee_block(":SYSTem:SETUp", array.array('B', setup_bytes))
print "Setup bytes restored: %d" % len(setup_bytes)

# Capture an acquisition using :DIGitize.
do_command(":DIGitize CHANnel1")

# =====

```

```

# Analyze:
# =====
def analyze():

    # Make measurements.
    # -----
    do_command(":MEASure:SOURce CHANnel1")
    qresult = do_query_string(":MEASure:SOURce?")
    print "Measure source: %s" % qresult

    do_command(":MEASure:FREQuency")
    qresult = do_query_string(":MEASure:FREQuency?")
    print "Measured frequency on channel 1: %s" % qresult

    do_command(":MEASure:VAMPlitude")
    qresult = do_query_string(":MEASure:VAMPlitude?")
    print "Measured vertical amplitude on channel 1: %s" % qresult

    # Download the screen image.
    # -----
    do_command(":HARDcopy:INKSaver OFF")

    image_bytes = do_query_ieee_block(":DISPlay:DATA? PNG, COLor")
    nLength = len(image_bytes)
    f = open("c:\scope\data\screen.png", "wb")
    f.write(bytearray(image_bytes))
    f.close()
    print "Screen image written to c:\scope\data\screen.png."

    # Download waveform data.
    # -----

    # Set the waveform points mode.
    do_command(":WAVEform:POINts:MODE RAW")
    qresult = do_query_string(":WAVEform:POINts:MODE?")
    print "Waveform points mode: %s" % qresult

    # Get the number of waveform points available.
    do_command(":WAVEform:POINts 10240")
    qresult = do_query_string(":WAVEform:POINts?")
    print "Waveform points available: %s" % qresult

    # Set the waveform source.
    do_command(":WAVEform:SOURce CHANnel1")
    qresult = do_query_string(":WAVEform:SOURce?")
    print "Waveform source: %s" % qresult

    # Choose the format of the data returned:
    do_command(":WAVEform:FORMat BYTE")
    print "Waveform format: %s" % do_query_string(":WAVEform:FORMat?")

    # Display the waveform settings from preamble:
    wav_form_dict = {
        0 : "BYTE",
        1 : "WORD",
        4 : "AScii",
    }

```

```

acq_type_dict = {
    0 : "NORMal",
    1 : "PEAK",
    2 : "AVERage",
    3 : "HRESolution",
}

(
    wav_form,
    acq_type,
    wfmpnts,
    avgcnt,
    x_increment,
    x_origin,
    x_reference,
    y_increment,
    y_origin,
    y_reference
) = do_query_numbers(":WAVEform:PREamble?")

print "Waveform format: %s" % wav_form_dict[wav_form]
print "Acquire type: %s" % acq_type_dict[acq_type]
print "Waveform points desired: %d" % wfmpnts
print "Waveform average count: %d" % avgcnt
print "Waveform X increment: %1.12f" % x_increment
print "Waveform X origin: %1.9f" % x_origin
print "Waveform X reference: %d" % x_reference # Always 0.
print "Waveform Y increment: %f" % y_increment
print "Waveform Y origin: %f" % y_origin
print "Waveform Y reference: %d" % y_reference # Always 125.

# Get numeric values for later calculations.
x_increment = do_query_number(":WAVEform:XINcrement?")
x_origin = do_query_number(":WAVEform:XORigin?")
y_increment = do_query_number(":WAVEform:YINcrement?")
y_origin = do_query_number(":WAVEform:YORigin?")
y_reference = do_query_number(":WAVEform:YREFERENCE?")

# Get the waveform data.
data_bytes = do_query_ieee_block(":WAVEform:DATA?")
nLength = len(data_bytes)
print "Number of data values: %d" % nLength

# Open file for output.
strPath = "c:\scope\data\waveform_data.csv"
f = open(strPath, "w")

# Output waveform data in CSV format.
for i in xrange(0, nLength - 1):
    time_val = x_origin + (i * x_increment)
    voltage = (data_bytes[i] - y_reference) * y_increment + y_origin
    f.write("%E, %f\n" % (time_val, voltage))

# Close output file.
f.close()
print "Waveform format BYTE data written to %s." % strPath

```



```

# =====
# Send a command and check for errors:
# =====
def do_command(command):
    myScope.WriteString("%s" % command, True)
    check_instrument_errors(command)

# =====
# Send a command and check for errors:
# =====
def do_command_ieee_block(command, data):
    myScope.WriteIEEEBlock(command, data, True)
    check_instrument_errors(command)

# =====
# Send a query, check for errors, return string:
# =====
def do_query_string(query):
    myScope.WriteString("%s" % query, True)
    result = myScope.ReadString()
    check_instrument_errors(query)
    return result

# =====
# Send a query, check for errors, return string:
# =====
def do_query_ieee_block(query):
    myScope.WriteString("%s" % query, True)
    result = myScope.ReadIEEEBlock(VisaComLib.BinaryType_UI1, \
        False, True)
    check_instrument_errors(query)
    return result

# =====
# Send a query, check for errors, return values:
# =====
def do_query_number(query):
    myScope.WriteString("%s" % query, True)
    result = myScope.ReadNumber(VisaComLib.ASCIIType_R8, True)
    check_instrument_errors(query)
    return result

# =====
# Send a query, check for errors, return values:
# =====
def do_query_numbers(query):
    myScope.WriteString("%s" % query, True)
    result = myScope.ReadList(VisaComLib.ASCIIType_R8, ",;")
    check_instrument_errors(query)
    return result

```

```

# =====
# Check for instrument errors:
# =====
def check_instrument_errors(command):

    while True:
        myScope.WriteString(":SYSTem:ERRor?", True)
        error_string = myScope.ReadString()
        if error_string: # If there is an error string value.

            if error_string.find("+0", 0, 3) == -1: # Not "No error".
                print "ERROR: %s, command: '%s'" % (error_string, command)
                print "Exited because of error."
                sys.exit(1)

            else: # "No error"
                break

        else: # :SYSTem:ERRor? should always return string.
            print "ERROR: :SYSTem:ERRor? returned nothing, command: '%s'" \
                % command
            print "Exited because of error."
            sys.exit(1)

# =====
# Main program:
# =====
rm = CreateObject("VISA.GlobalRM", \
    interface=VisaComLib.IResourceManager)
myScope = CreateObject("VISA.BasicFormattedIO", \
    interface=VisaComLib.IFormattedIO488)
myScope.IO = \
    rm.Open("TCPIP0::a-mx3104a-90028.cos.keysight.com::inst0::INSTR")

# Clear the interface.
myScope.IO.Clear
print "Interface cleared."

# Set the Timeout to 15 seconds.
myScope.IO.Timeout = 15000 # 15 seconds.
print "Timeout set to 15000 milliseconds."

# Initialize the oscilloscope, capture data, and analyze.
initialize()
capture()
analyze()

print "End of program"

```

VISA Examples

- ["VISA Example in C"](#) on page 1427
- ["VISA Example in Visual Basic"](#) on page 1436
- ["VISA Example in C#"](#) on page 1446
- ["VISA Example in Visual Basic .NET"](#) on page 1457
- ["VISA Example in Python \(PyVISA 1.5 and older\)"](#) on page 1467
- ["VISA Example in Python \(PyVISA 1.6 and newer\)"](#) on page 1473

VISA Example in C

To compile and run this example in Microsoft Visual Studio 2008:

- 1 Open Visual Studio.
- 2 Create a new Visual C++, Win32, Win32 Console Application project.
- 3 In the Win32 Application Wizard, click **Next >**. Then, check **Empty project**, and click **Finish**.
- 4 Cut-and-paste the code that follows into a file named "example.c" in the project directory.
- 5 In Visual Studio 2008, right-click the Source Files folder, choose **Add > Add Existing Item...**, select the example.c file, and click **Add**.
- 6 Edit the program to use the VISA address of your oscilloscope.
- 7 Choose **Project > Properties....** In the Property Pages dialog, update these project settings:
 - a Under Configuration Properties, Linker, Input, add "visa32.lib" to the Additional Dependencies field.
 - b Under Configuration Properties, C/C++, Code Generation, select Multi-threaded DLL for the Runtime Library field.
 - c Click **OK** to close the Property Pages dialog.
- 8 Add the include files and library files search paths:
 - a Choose **Tools > Options....**
 - b In the Options dialog, under Projects and Solutions, select **VC++ Directories**.
 - c Show directories for **Include files**, and add the include directory (for example, Program Files (x86)\IVI Foundation\VISA\WinNT\Include).
 - d Show directories for **Library files**, and add the library files directory (for example, Program Files (x86)\IVI Foundation\VISA\WinNT\lib\msc).
 - e Click **OK** to close the Options dialog.
- 9 Build and run the program.

```

/*
 * Keysight VISA Example in C
 * -----
 * This program illustrates a few commonly-used programming
 * features of your Keysight oscilloscope.
 */

#include <stdio.h>           /* For printf(). */
#include <string.h>         /* For strcpy(), strcat(). */
#include <time.h>           /* For clock(). */
#include <visa.h>           /* Keysight VISA routines. */

#define VISA_ADDRESS "USB0::0x0957::0x17A6::US50210029::0::INSTR"
#define IEEEBLOCK_SPACE 5000000

/* Function prototypes */
void initialize(void);      /* Initialize to known state. */
void capture(void);        /* Capture the waveform. */
void analyze(void);        /* Analyze the captured waveform. */

void do_command(char *command); /* Send command. */
int do_command_ieeeblock(char *command); /* Command w/IEEE block. */
void do_query_string(char *query); /* Query for string. */
void do_query_number(char *query); /* Query for number. */
void do_query_numbers(char *query); /* Query for numbers. */
int do_query_ieeeblock(char *query); /* Query for IEEE block. */
void check_instrument_errors(); /* Check for inst errors. */
void error_handler();        /* VISA error handler. */

/* Global variables */
ViSession defaultRM, vi;    /* Device session ID. */
ViStatus err;              /* VISA function return value. */
char str_result[256] = {0}; /* Result from do_query_string(). */
double num_result;         /* Result from do_query_number(). */
unsigned char ieeeblock_data[IEEEBLOCK_SPACE]; /* Result from
do_query_ieeeblock(). */
double dbl_results[10];    /* Result from do_query_numbers(). */

/* Main Program
 * ----- */
void main(void)
{
    /* Open the default resource manager session. */
    err = viOpenDefaultRM(&defaultRM);
    if (err != VI_SUCCESS) error_handler();

    /* Open the session using the oscilloscope's VISA address. */
    err = viOpen(defaultRM, VISA_ADDRESS, VI_NULL, VI_NULL, &vi);
    if (err != VI_SUCCESS) error_handler();

    /* Set the I/O timeout to fifteen seconds. */
    err = viSetAttribute(vi, VI_ATTR_TMO_VALUE, 15000);
    if (err != VI_SUCCESS) error_handler();

    /* Initialize - start from a known state. */
    initialize();
}

```

```

/* Capture data. */
capture();

/* Analyze the captured waveform. */
analyze();

/* Close the vi session and the resource manager session. */
viClose(vi);
viClose(defaultRM);
}

/* Initialize the oscilloscope to a known state.
 * ----- */
void initialize (void)
{
    /* Clear the interface. */
    err = viClear(vi);
    if (err != VI_SUCCESS) error_handler();

    /* Get and display the device's *IDN? string. */
    do_query_string("*IDN?");
    printf("Oscilloscope *IDN? string: %s\n", str_result);

    /* Clear status and load the default setup. */
    do_command("*CLS");
    do_command("*RST");
}

/* Capture the waveform.
 * ----- */
void capture (void)
{
    int num_bytes;
    FILE *fp;

    /* Use auto-scale to automatically configure oscilloscope. */
    do_command(":AUToscale");

    /* Set trigger mode (EDGE, PULSe, PATtern, etc., and input source. */
    do_command(":TRIGger:MODE EDGE");
    do_query_string(":TRIGger:MODE?");
    printf("Trigger mode: %s\n", str_result);

    /* Set EDGE trigger parameters. */
    do_command(":TRIGger:EDGE:SOURce CHANnel1");
    do_query_string(":TRIGger:EDGE:SOURce?");
    printf("Trigger edge source: %s\n", str_result);

    do_command(":TRIGger:EDGE:LEVel 1.5");
    do_query_string(":TRIGger:EDGE:LEVel?");
    printf("Trigger edge level: %s\n", str_result);

    do_command(":TRIGger:EDGE:SLOPe POSitive");
    do_query_string(":TRIGger:EDGE:SLOPe?");
    printf("Trigger edge slope: %s\n", str_result);

    /* Save oscilloscope configuration. */

```

```

/* Read system setup. */
num_bytes = do_query_ieeeblock(":SYSTEM:SETup?");
printf("Read setup string query (%d bytes).\n", num_bytes);

/* Write setup string to file. */
fp = fopen ("c:\\scope\\config\\setup.stp", "wb");
num_bytes = fwrite(ieeeblock_data, sizeof(unsigned char), num_bytes,
    fp);
fclose (fp);
printf("Wrote setup string (%d bytes) to ", num_bytes);
printf("c:\\scope\\config\\setup.stp.\n");

/* Change settings with individual commands:

/* Set vertical scale and offset. */
do_command(":CHANnel1:SCALE 0.05");
do_query_string(":CHANnel1:SCALE?");
printf("Channel 1 vertical scale: %s\n", str_result);

do_command(":CHANnel1:OFFSet -1.5");
do_query_string(":CHANnel1:OFFSet?");
printf("Channel 1 offset: %s\n", str_result);

/* Set horizontal scale and offset. */
do_command(":TIMEbase:SCALE 0.0002");
do_query_string(":TIMEbase:SCALE?");
printf("Timebase scale: %s\n", str_result);

do_command(":TIMEbase:POSition 0.0");
do_query_string(":TIMEbase:POSition?");
printf("Timebase position: %s\n", str_result);

/* Set the acquisition type (NORMAL, PEAK, AVERAGE, or HRESolution). *
/
do_command(":ACquire:TYPE NORMal");
do_query_string(":ACquire:TYPE?");
printf("Acquire type: %s\n", str_result);

/* Or, configure by loading a previously saved setup. */

/* Read setup string from file. */
fp = fopen ("c:\\scope\\config\\setup.stp", "rb");
num_bytes = fread (ieeeblock_data, sizeof(unsigned char),
    IEEEBLOCK_SPACE, fp);
fclose (fp);
printf("Read setup string (%d bytes) from file ", num_bytes);
printf("c:\\scope\\config\\setup.stp.\n");

/* Restore setup string. */
num_bytes = do_command_ieeeblock(":SYSTEM:SETup", num_bytes);
printf("Restored setup string (%d bytes).\n", num_bytes);

/* Capture an acquisition using :DIGitize. */
do_command(":DIGitize CHANnel1");
}

```

```

/* Analyze the captured waveform.
 * ----- */
void analyze (void)
{
    double wav_format;
    double acq_type;
    double wav_points;
    double avg_count;
    double x_increment;
    double x_origin;
    double x_reference;
    double y_increment;
    double y_origin;
    double y_reference;

    FILE *fp;
    int num_bytes; /* Number of bytes returned from instrument. */
    int i;

    /* Make a couple of measurements.
     * ----- */
    do_command(":MEASure:SOURce CHANnel1");
    do_query_string(":MEASure:SOURce?");
    printf("Measure source: %s\n", str_result);

    do_command(":MEASure:FREQuency");
    do_query_number(":MEASure:FREQuency?");
    printf("Frequency: %.4f kHz\n", num_result / 1000);

    do_command(":MEASure:VAMplitude");
    do_query_number(":MEASure:VAMplitude?");
    printf("Vertical amplitude: %.2f V\n", num_result);

    /* Download the screen image.
     * ----- */
    do_command(":HARDcopy:INKSaver OFF");

    /* Read screen image. */
    num_bytes = do_query_ieeeblock(":DISPlay:DATA? PNG, COLor");
    printf("Screen image bytes: %d\n", num_bytes);

    /* Write screen image bytes to file. */
    fp = fopen ("c:\\scope\\data\\screen.png", "wb");
    num_bytes = fwrite(ieeeblock_data, sizeof(unsigned char), num_bytes,
        fp);
    fclose (fp);
    printf("Wrote screen image (%d bytes) to ", num_bytes);
    printf("c:\\scope\\data\\screen.png.\n");

    /* Download waveform data.
     * ----- */

    /* Set the waveform points mode. */
    do_command(":WAVEform:POINts:MODE RAW");
    do_query_string(":WAVEform:POINts:MODE?");
    printf("Waveform points mode: %s\n", str_result);

```

```

/* Get the number of waveform points available. */
do_query_string(":WAVEform:POINTs?");
printf("Waveform points available: %s\n", str_result);

/* Set the waveform source. */
do_command(":WAVEform:SOURce CHANnel1");
do_query_string(":WAVEform:SOURce?");
printf("Waveform source: %s\n", str_result);

/* Choose the format of the data returned (WORD, BYTE, ASCII): */
do_command(":WAVEform:FORMat BYTE");
do_query_string(":WAVEform:FORMat?");
printf("Waveform format: %s\n", str_result);

/* Display the waveform settings: */
do_query_numbers(":WAVEform:PREAmble?");

wav_format = dbl_results[0];
if (wav_format == 0.0)
{
    printf("Waveform format: BYTE\n");
}
else if (wav_format == 1.0)
{
    printf("Waveform format: WORD\n");
}
else if (wav_format == 2.0)
{
    printf("Waveform format: ASCii\n");
}

acq_type = dbl_results[1];
if (acq_type == 0.0)
{
    printf("Acquire type: NORMal\n");
}
else if (acq_type == 1.0)
{
    printf("Acquire type: PEAK\n");
}
else if (acq_type == 2.0)
{
    printf("Acquire type: AVERage\n");
}
else if (acq_type == 3.0)
{
    printf("Acquire type: HRESolution\n");
}

wav_points = dbl_results[2];
printf("Waveform points: %e\n", wav_points);

avg_count = dbl_results[3];
printf("Waveform average count: %e\n", avg_count);

x_increment = dbl_results[4];
printf("Waveform X increment: %e\n", x_increment);

```



```

x_origin = dbl_results[5];
printf("Waveform X origin: %e\n", x_origin);

x_reference = dbl_results[6];
printf("Waveform X reference: %e\n", x_reference);

y_increment = dbl_results[7];
printf("Waveform Y increment: %e\n", y_increment);

y_origin = dbl_results[8];
printf("Waveform Y origin: %e\n", y_origin);

y_reference = dbl_results[9];
printf("Waveform Y reference: %e\n", y_reference);

/* Read waveform data. */
num_bytes = do_query_ieeeblock(":WAVEform:DATA?");
printf("Number of data values: %d\n", num_bytes);

/* Open file for output. */
fp = fopen("c:\\scope\\data\\waveform_data.csv", "wb");

/* Output waveform data in CSV format. */
for (i = 0; i < num_bytes - 1; i++)
{
    /* Write time value, voltage value. */
    fprintf(fp, "%9f, %6f\n",
        x_origin + ((float)i * x_increment),
        (((float)ieeeblock_data[i] - y_reference) * y_increment)
        + y_origin);
}

/* Close output file. */
fclose(fp);
printf("Waveform format BYTE data written to ");
printf("c:\\scope\\data\\waveform_data.csv.\n");
}

/* Send a command to the instrument.
 * ----- */
void do_command(command)
char *command;
{
    char message[80];

    strcpy(message, command);
    strcat(message, "\n");
    err = viPrintf(vi, message);
    if (err != VI_SUCCESS) error_handler();

    check_instrument_errors();
}

/* Command with IEEE definite-length block.
 * ----- */
int do_command_ieeeblock(command, num_bytes)

```

```

char *command;
int num_bytes;
{
    char message[80];
    int data_length;

    strcpy(message, command);
    strcat(message, " #8%08d");
    err = viPrintf(vi, message, num_bytes);
    if (err != VI_SUCCESS) error_handler();

    err = viBufWrite(vi, ieeeblock_data, num_bytes, &data_length);
    if (err != VI_SUCCESS) error_handler();

    check_instrument_errors();

    return(data_length);
}

/* Query for a string result.
 * ----- */
void do_query_string(query)
char *query;
{
    char message[80];

    strcpy(message, query);
    strcat(message, "\n");

    err = viPrintf(vi, message);
    if (err != VI_SUCCESS) error_handler();

    err = viScanf(vi, "%t", str_result);
    if (err != VI_SUCCESS) error_handler();

    check_instrument_errors();
}

/* Query for a number result.
 * ----- */
void do_query_number(query)
char *query;
{
    char message[80];

    strcpy(message, query);
    strcat(message, "\n");

    err = viPrintf(vi, message);
    if (err != VI_SUCCESS) error_handler();

    err = viScanf(vi, "%lf", &num_result);
    if (err != VI_SUCCESS) error_handler();

    check_instrument_errors();
}

```

```

/* Query for numbers result.
 * ----- */
void do_query_numbers(query)
char *query;
{
    char message[80];

    strcpy(message, query);
    strcat(message, "\n");

    err = viPrintf(vi, message);
    if (err != VI_SUCCESS) error_handler();

    err = viScanf(vi, "%,10lf\n", dbl_results);
    if (err != VI_SUCCESS) error_handler();

    check_instrument_errors();
}

/* Query for an IEEE definite-length block result.
 * ----- */
int do_query_ieeeblock(query)
char *query;
{
    char message[80];
    int data_length;

    strcpy(message, query);
    strcat(message, "\n");
    err = viPrintf(vi, message);
    if (err != VI_SUCCESS) error_handler();

    data_length = IEEEBLOCK_SPACE;
    err = viScanf(vi, "%#b\n", &data_length, ieeeblock_data);
    if (err != VI_SUCCESS) error_handler();

    if (data_length == IEEEBLOCK_SPACE )
    {
        printf("IEEE block buffer full: ");
        printf("May not have received all data.\n");
    }

    check_instrument_errors();

    return(data_length);
}

/* Check for instrument errors.
 * ----- */
void check_instrument_errors()
{
    char str_err_val[256] = {0};
    char str_out[800] = "";

    err = viQueryf(vi, ":SYSTem:ERRor?\n", "%t", str_err_val);
    if (err != VI_SUCCESS) error_handler();
    while(strncmp(str_err_val, "+0,No error", 3) != 0 )

```

```

    {
        strcat(str_out, ", ");
        strcat(str_out, str_err_val);
        err = viQueryf(vi, ":SYSTem:ERror?\n", "%t", str_err_val);
        if (err != VI_SUCCESS) error_handler();
    }

    if (strcmp(str_out, "") != 0)
    {
        printf("INST Error%s\n", str_out);
        err = viFlush(vi, VI_READ_BUF);
        if (err != VI_SUCCESS) error_handler();
        err = viFlush(vi, VI_WRITE_BUF);
        if (err != VI_SUCCESS) error_handler();
    }
}

/* Handle VISA errors.
 * ----- */
void error_handler()
{
    char err_msg[1024] = {0};

    viStatusDesc(vi, err, err_msg);
    printf("VISA Error: %s\n", err_msg);
    if (err < VI_SUCCESS)
    {
        exit(1);
    }
}

```

VISA Example in Visual Basic

To run this example in Visual Basic for Applications:

- 1 Start the application that provides Visual Basic for Applications (for example, Microsoft Excel).
- 2 Press ALT+F11 to launch the Visual Basic editor.
- 3 Add the visa32.bas file to your project:
 - a Choose **File > Import File...**
 - b Navigate to the header file, visa32.bas (installed with Keysight IO Libraries Suite and found in the Program Files (x86)\IVI Foundation\VISA\WinNT\Include), select it, and click **Open**.
- 4 Choose **Insert > Module**.
- 5 Cut-and-paste the code that follows into the editor.
- 6 Edit the program to use the VISA address of your oscilloscope, and save the changes.
- 7 Run the program.

```

'
' Keysight VISA Example in Visual Basic
' -----
' This program illustrates a few commonly-used programming
' features of your Keysight oscilloscope.
' -----

Option Explicit

Public err As Long      ' Error returned by VISA function calls.
Public drm As Long     ' Session to Default Resource Manager.
Public vi As Long      ' Session to instrument.

' Declare variables to hold numeric values returned by
' viVScanf/viVQueryf.
Public dblQueryResult As Double
Public Const ByteArraySize = 5000000
Public retCount As Long
Public byteArray(ByteArraySize) As Byte
Public paramsArray(2) As Long
Public Const DblArraySize = 20
Public dblArray(DblArraySize) As Double

' Declare fixed length string variable to hold string value returned
' by viVScanf/viVQueryf.
Public strQueryResult As String * 200

' For Sleep subroutine.
Private Declare Sub Sleep Lib "kernel32" (ByVal dwMilliseconds As Long)

'
' Main Program
' -----

Sub Main()

    ' Open the default resource manager session.
    err = viOpenDefaultRM(drm)
    If (err <> VI_SUCCESS) Then HandleVISAError drm

    ' Open the session using the oscilloscope's VISA address.
    err = viOpen(drm, _
        "USB0::0x0957::0x17A6::US50210029::0::INSTR", 0, 15000, vi)
    If (err <> VI_SUCCESS) Then HandleVISAError drm

    ' Set the I/O timeout to ten seconds.
    err = viSetAttribute(vi, VI_ATTR_TMO_VALUE, 10000)
    If (err <> VI_SUCCESS) Then HandleVISAError vi

    ' Initialize - start from a known state.
    Initialize

    ' Capture data.
    Capture

    ' Analyze the captured waveform.
    Analyze

```

```

    ' Close the vi session and the resource manager session.
    err = viClose(vi)
    err = viClose(drm)

End Sub

'
' Initialize the oscilloscope to a known state.
' -----

Private Sub Initialize()

    ' Clear the interface.
    err = viClear(vi)
    If Not (err = VI_SUCCESS) Then HandleVISAError vi

    ' Get and display the device's *IDN? string.
    strQueryResult = DoQueryString("*IDN?")
    MsgBox "*IDN? string: " + strQueryResult, vbOKOnly, "*IDN? Result"

    ' Clear status and load the default setup.
    DoCommand "*CLS"
    DoCommand "*RST"

End Sub

'
' Capture the waveform.
' -----

Private Sub Capture()

    ' Use auto-scale to automatically configure oscilloscope.
    ' -----
    DoCommand ":AUToscale"

    ' Set trigger mode (EDGE, PULSe, PATtern, etc., and input source.
    DoCommand ":TRIGger:MODE EDGE"
    Debug.Print "Trigger mode: " + _
        DoQueryString(":TRIGger:MODE?")

    ' Set EDGE trigger parameters.
    DoCommand ":TRIGger:EDGE:SOURce CHANnel1"
    Debug.Print "Trigger edge source: " + _
        DoQueryString(":TRIGger:EDGE:SOURce?")

    DoCommand ":TRIGger:EDGE:LEVel 1.5"
    Debug.Print "Trigger edge level: " + _
        DoQueryString(":TRIGger:EDGE:LEVel?")

    DoCommand ":TRIGger:EDGE:SLOPe POSitive"
    Debug.Print "Trigger edge slope: " + _
        DoQueryString(":TRIGger:EDGE:SLOPe?")

    ' Save oscilloscope configuration.
    ' -----

```

```

Dim lngSetupStringSize As Long
lngSetupStringSize = DoQueryIEEEBlock_Bytes(":SYSTEM:SETup?")
Debug.Print "Setup bytes saved: " + CStr(lngSetupStringSize)

' Output setup string to a file:
Dim strPath As String
strPath = "c:\scope\config\setup.dat"
If Len(Dir(strPath)) Then
    Kill strPath ' Remove file if it exists.
End If

' Open file for output.
Dim hFile As Long
hFile = FreeFile
Open strPath For Binary Access Write Lock Write As hFile
Dim lngI As Long
For lngI = 0 To lngSetupStringSize - 1
    Put hFile, , byteArray(lngI) ' Write data.
Next lngI
Close hFile ' Close file.

' Change settings with individual commands:
' -----

' Set vertical scale and offset.
DoCommand ":CHANnel1:SCALE 0.05"
Debug.Print "Channel 1 vertical scale: " + _
    DoQueryString(":CHANnel1:SCALE?")

DoCommand ":CHANnel1:OFFSet -1.5"
Debug.Print "Channel 1 vertical offset: " + _
    DoQueryString(":CHANnel1:OFFSet?")

' Set horizontal scale and position.
DoCommand ":TIMEbase:SCALE 0.0002"
Debug.Print "Timebase scale: " + _
    DoQueryString(":TIMEbase:SCALE?")

DoCommand ":TIMEbase:POSition 0.0"
Debug.Print "Timebase position: " + _
    DoQueryString(":TIMEbase:POSition?")

' Set the acquisition type (NORMAL, PEAK, AVERage, or HRESolution).
DoCommand ":ACQuire:TYPE NORMAL"
Debug.Print "Acquire type: " + _
    DoQueryString(":ACQuire:TYPE?")

' Or, configure by loading a previously saved setup.
' -----
strPath = "c:\scope\config\setup.dat"
Open strPath For Binary Access Read As hFile ' Open file for input.
Dim lngSetupFileSize As Long
lngSetupFileSize = LOF(hFile) ' Length of file.
Get hFile, , byteArray ' Read data.
Close hFile ' Close file.
' Write learn string back to oscilloscope using ":SYSTEM:SETup"
' command:

```

```

Dim lngRestored As Long
lngRestored = DoCommandIEEEBlock(":SYSTEM:SETup", lngSetupFileSize)
Debug.Print "Setup bytes restored: " + CStr(lngRestored)

' Capture an acquisition using :DIGitize.
' -----
DoCommand ":DIGitize CHANnel1"

End Sub

'
' Analyze the captured waveform.
' -----

Private Sub Analyze()

' Make a couple of measurements.
' -----
DoCommand ":MEASure:SOURce CHANnel1"
Debug.Print "Measure source: " + _
    DoQueryString(":MEASure:SOURce?")

DoCommand ":MEASure:FREQuency"
dblQueryResult = DoQueryNumber(":MEASure:FREQuency?")
MsgBox "Frequency:" + vbCrLf + _
    FormatNumber(dblQueryResult / 1000, 4) + " kHz"

DoCommand ":MEASure:VAMPlitude"
dblQueryResult = DoQueryNumber(":MEASure:VAMPlitude?")
MsgBox "Vertical amplitude:" + vbCrLf + _
    FormatNumber(dblQueryResult, 4) + " V"

' Download the screen image.
' -----
DoCommand ":HARDcopy:INKSaver OFF"

' Get screen image.
Dim lngBlockSize As Long
lngBlockSize = DoQueryIEEEBlock_Bytes(":DISPlay:DATA? PNG, COLor")
Debug.Print "Screen image bytes: " + CStr(lngBlockSize)

' Save screen image to a file:
Dim strPath As String
strPath = "c:\scope\data\screen.png"
If Len(Dir(strPath)) Then
    Kill strPath ' Remove file if it exists.
End If
Dim hFile As Long
hFile = FreeFile
Open strPath For Binary Access Write Lock Write As hFile
Dim lngI As Long
For lngI = 0 To lngBlockSize - 1
    Put hFile, , byteArray(lngI) ' Write data.
Next lngI
Close hFile ' Close file.
MsgBox "Screen image written to " + strPath

```



```

' Download waveform data.
' -----

' Set the waveform points mode.
DoCommand ":WAVEform:POINTs:MODE RAW"
Debug.Print "Waveform points mode: " + _
    DoQueryString(":WAVEform:POINTs:MODE?")

' Get the number of waveform points available.
Debug.Print "Waveform points available: " + _
    DoQueryString(":WAVEform:POINTs?")

' Set the waveform source.
DoCommand ":WAVEform:SOURce CHANnel1"
Debug.Print "Waveform source: " + _
    DoQueryString(":WAVEform:SOURce?")

' Choose the format of the data returned (WORD, BYTE, ASCII):
DoCommand ":WAVEform:FORMat BYTE"
Debug.Print "Waveform format: " + _
    DoQueryString(":WAVEform:FORMat?")

' Display the waveform settings:
Dim intFormat As Integer
Dim intType As Integer
Dim lngPoints As Long
Dim lngCount As Long
Dim dblXIncrement As Double
Dim dblXOrigin As Double
Dim lngXReference As Long
Dim sngYIncrement As Single
Dim lngYOrigin As Long
Dim lngYReference As Long
Dim strOutput As String

Dim lngNumNumbers As Long
lngNumNumbers = DoQueryNumbers(":WAVEform:PREamble?")

intFormat = dblArray(0)
intType = dblArray(1)
lngPoints = dblArray(2)
lngCount = dblArray(3)
dblXIncrement = dblArray(4)
dblXOrigin = dblArray(5)
lngXReference = dblArray(6)
sngYIncrement = dblArray(7)
lngYOrigin = dblArray(8)
lngYReference = dblArray(9)

If intFormat = 0 Then
    Debug.Print "Waveform format: BYTE"
ElseIf intFormat = 1 Then
    Debug.Print "Waveform format: WORD"
ElseIf intFormat = 2 Then
    Debug.Print "Waveform format: ASCii"

```

```

End If

If intType = 0 Then
    Debug.Print "Acquisition type: NORMAl"
ElseIf intType = 1 Then
    Debug.Print "Acquisition type: PEAK"
ElseIf intType = 2 Then
    Debug.Print "Acquisition type: AVERAge"
ElseIf intType = 3 Then
    Debug.Print "Acquisition type: HRESolution"
End If

Debug.Print "Waveform points: " + _
    FormatNumber(lngPoints, 0)

Debug.Print "Waveform average count: " + _
    FormatNumber(lngCount, 0)

Debug.Print "Waveform X increment: " + _
    Format(dblXIncrement, "Scientific")

Debug.Print "Waveform X origin: " + _
    Format(dblXOrigin, "Scientific")

Debug.Print "Waveform X reference: " + _
    FormatNumber(lngXReference, 0)

Debug.Print "Waveform Y increment: " + _
    Format(sngYIncrement, "Scientific")

Debug.Print "Waveform Y origin: " + _
    FormatNumber(lngYOrigin, 0)

Debug.Print "Waveform Y reference: " + _
    FormatNumber(lngYReference, 0)

' Get the waveform data
Dim lngNumBytes As Long
lngNumBytes = DoQueryIEEEBlock_Bytes(":WAVEform:DATA?")
Debug.Print "Number of data values: " + CStr(lngNumBytes)

' Set up output file:
strPath = "c:\scope\data\waveform_data.csv"

' Open file for output.
Open strPath For Output Access Write Lock Write As hFile

' Output waveform data in CSV format.
Dim lngDataValue As Long

For lngI = 0 To lngNumBytes - 1
    lngDataValue = CLng(byteArray(lngI))

    ' Write time value, voltage value.
    Print #hFile, _
        FormatNumber(dblXOrigin + (lngI * dblXIncrement), 9) + _
        ", " + _

```

```

        FormatNumber(((lngDataValue - lngYReference) _
        * sngYIncrement) + lngYOrigin)

Next lngI

' Close output file.
Close hFile ' Close file.
MsgBox "Waveform format BYTE data written to " + _
        "c:\scope\data\waveform_data.csv."

End Sub

Private Sub DoCommand(command As String)

    err = viVPrintf(vi, command + vbLf, 0)
    If (err <> VI_SUCCESS) Then HandleVISAError vi

    CheckInstrumentErrors

End Sub

Private Function DoCommandIEEEBlock(command As String, _
    lngBlockSize As Long)

    retCount = lngBlockSize

    Dim strCommandAndLength As String
    strCommandAndLength = command + " %#" + _
        Format(lngBlockSize) + "b"

    err = viVPrintf(vi, strCommandAndLength + vbLf, paramsArray(1))
    If (err <> VI_SUCCESS) Then HandleVISAError vi

    DoCommandIEEEBlock = retCount

    CheckInstrumentErrors

End Function

Private Function DoQueryString(query As String) As String

    Dim strResult As String * 200

    err = viVPrintf(vi, query + vbLf, 0)
    If (err <> VI_SUCCESS) Then HandleVISAError vi

    err = viVScanf(vi, "%t", strResult)
    If (err <> VI_SUCCESS) Then HandleVISAError vi

    DoQueryString = strResult

    CheckInstrumentErrors

End Function

Private Function DoQueryNumber(query As String) As Variant

```

```

Dim dblResult As Double

err = viVPrintf(vi, query + vbLf, 0)
If (err <> VI_SUCCESS) Then HandleVISAError vi

err = viVScanf(vi, "%lf" + vbLf, VarPtr(dblResult))
If (err <> VI_SUCCESS) Then HandleVISAError vi

DoQueryNumber = dblResult

CheckInstrumentErrors

End Function

Private Function DoQueryNumbers(query As String) As Long

Dim dblResult As Double

' Send query.
err = viVPrintf(vi, query + vbLf, 0)
If (err <> VI_SUCCESS) Then HandleVISAError vi

' Set up paramsArray for multiple parameter query returning array.
paramsArray(0) = VarPtr(retCount)
paramsArray(1) = VarPtr(dblArray(0))

' Set retCount to max number of elements array can hold.
retCount = DblArraySize

' Read numbers.
err = viVScanf(vi, "%,#lf" + vbLf, paramsArray(0))
If (err <> VI_SUCCESS) Then HandleVISAError vi

' retCount is now actual number of values returned by query.
DoQueryNumbers = retCount

CheckInstrumentErrors

End Function

Private Function DoQueryIEEEBlock_Bytes(query As String) As Long

' Send query.
err = viVPrintf(vi, query + vbLf, 0)
If (err <> VI_SUCCESS) Then HandleVISAError vi

' Set up paramsArray for multiple parameter query returning array.
paramsArray(0) = VarPtr(retCount)
paramsArray(1) = VarPtr(byteArray(0))

' Set retCount to max number of elements array can hold.
retCount = ByteArraySize

' Get unsigned integer bytes.
err = viVScanf(vi, "%#b" + vbLf, paramsArray(0))
If (err <> VI_SUCCESS) Then HandleVISAError vi

```

```

err = viFlush(vi, VI_READ_BUF)
If (err <> VI_SUCCESS) Then HandleVISAError vi

err = viFlush(vi, VI_WRITE_BUF)
If (err <> VI_SUCCESS) Then HandleVISAError vi

' retCount is now actual number of bytes returned by query.
DoQueryIEEEBlock_Bytes = retCount

CheckInstrumentErrors

End Function

Private Sub CheckInstrumentErrors()

On Error GoTo ErrorHandler

Dim strErrVal As String * 200
Dim strOut As String

err = viVPrintf(vi, ":SYSTem:ERror?" + vbLf, 0) ' Query any errors.
If (err <> VI_SUCCESS) Then HandleVISAError vi

err = viVScanf(vi, "%t", strErrVal) ' Read: Errnum,"Error String".
If (err <> VI_SUCCESS) Then HandleVISAError vi

While Val(strErrVal) <> 0 ' End if find: 0,"No Error".
strOut = strOut + "INST Error: " + strErrVal

err = viVPrintf(vi, ":SYSTem:ERror?" + vbLf, 0) ' Request error.
If (err <> VI_SUCCESS) Then HandleVISAError vi

err = viVScanf(vi, "%t", strErrVal) ' Read error message.
If (err <> VI_SUCCESS) Then HandleVISAError vi

Wend

If Not strOut = "" Then
MsgBox strOut, vbExclamation, "INST Error Messages"

err = viFlush(vi, VI_READ_BUF)
If (err <> VI_SUCCESS) Then HandleVISAError vi

err = viFlush(vi, VI_WRITE_BUF)
If (err <> VI_SUCCESS) Then HandleVISAError vi

End If

Exit Sub

ErrorHandler:

MsgBox "*** Error : " + Error, vbExclamation
End

End Sub

```

```

Private Sub HandleVISAError(session As Long)

    Dim strVisaErr As String * 200
    Call viStatusDesc(session, err, strVisaErr)
    MsgBox "*** VISA Error : " + strVisaErr, vbExclamation

    ' If the error is not a warning, close the session.
    If err < VI_SUCCESS Then
        If session <> 0 Then Call viClose(session)
        End
    End If

End Sub

```

VISA Example in C#

To compile and run this example in Microsoft Visual Studio 2008:

- 1 Open Visual Studio.
- 2 Create a new Visual C#, Windows, Console Application project.
- 3 Cut-and-paste the code that follows into the C# source file.
- 4 Edit the program to use the VISA address of your oscilloscope.
- 5 Add Keysight's VISA header file to your project:
 - a Right-click the project you wish to modify (not the solution) in the Solution Explorer window of the Microsoft Visual Studio environment.
 - b Click **Add** and then click **Add Existing Item...**
 - c Navigate to the header file, visa32.cs (installed with Keysight IO Libraries Suite and found in the Program Files (x86)\IVI Foundation\VISA\WinNT\Include directory), select it, but *do not click the Open button*.
 - d Click the down arrow to the right of the **Add** button, and choose **Add as Link**.

You should now see the file underneath your project in the Solution Explorer. It will have a little arrow icon in its lower left corner, indicating that it is a link.

- 6 Build and run the program.

For more information, see the tutorial on using VISA in Microsoft .NET in the VISA Help that comes with Keysight IO Libraries Suite 17.

```

/*
 * Keysight VISA Example in C#
 * -----
 * This program illustrates a few commonly used programming
 * features of your Keysight oscilloscope.
 * -----
 */

using System;
using System.IO;
using System.Text;

```

```

namespace InfiniiVision
{
    class VisaInstrumentApp
    {
        private static VisaInstrument myScope;

        public static void Main(string[] args)
        {
            try
            {
                myScope = new
                    VisaInstrument("USB0::0x0957::0x17A6::US50210029::0::INSTR");
                myScope.SetTimeoutSeconds(10);

                // Initialize - start from a known state.
                Initialize();

                // Capture data.
                Capture();

                // Analyze the captured waveform.
                Analyze();

            }
            catch (System.ApplicationException err)
            {
                Console.WriteLine("*** VISA Error Message : " + err.Message);
            }
            catch (System.SystemException err)
            {
                Console.WriteLine("*** System Error Message : " + err.Message);
            }
            catch (System.Exception err)
            {
                System.Diagnostics.Debug.Fail("Unexpected Error");
                Console.WriteLine("*** Unexpected Error : " + err.Message);
            }
            finally
            {
                myScope.Close();
            }
        }

        /*
        * Initialize the oscilloscope to a known state.
        * -----
        */
        private static void Initialize()
        {
            StringBuilder strResults;

            // Get and display the device's *IDN? string.
            strResults = myScope.DoQueryString("*IDN?");
            Console.WriteLine("*IDN? result is: {0}", strResults);

            // Clear status and load the default setup.

```

```

    myScope.DoCommand("*CLS");
    myScope.DoCommand("*RST");
}

/*
 * Capture the waveform.
 * -----
 */
private static void Capture()
{
    // Use auto-scale to automatically configure oscilloscope.
    myScope.DoCommand(":AUToscale");

    // Set trigger mode (EDGE, PULSe, PATtern, etc., and input source.
    myScope.DoCommand(":TRIGger:MODE EDGE");
    Console.WriteLine("Trigger mode: {0}",
        myScope.DoQueryString(":TRIGger:MODE?"));

    // Set EDGE trigger parameters.
    myScope.DoCommand(":TRIGger:EDGE:SOURce CHANnel1");
    Console.WriteLine("Trigger edge source: {0}",
        myScope.DoQueryString(":TRIGger:EDGE:SOURce?"));

    myScope.DoCommand(":TRIGger:EDGE:LEVel 1.5");
    Console.WriteLine("Trigger edge level: {0}",
        myScope.DoQueryString(":TRIGger:EDGE:LEVel?"));

    myScope.DoCommand(":TRIGger:EDGE:SLOPe POSitive");
    Console.WriteLine("Trigger edge slope: {0}",
        myScope.DoQueryString(":TRIGger:EDGE:SLOPe?"));

    // Save oscilloscope configuration.
    byte[] ResultsArray; // Results array.
    int nLength; // Number of bytes returned from instrument.
    string strPath;

    // Query and read setup string.
    nLength = myScope.DoQueryIEEEBlock(":SYSTem:SETup?",
        out ResultsArray);

    // Write setup string to file.
    strPath = "c:\\scope\\config\\setup.stp";
    FileStream fStream = File.Open(strPath, FileMode.Create);
    fStream.Write(ResultsArray, 0, nLength);
    fStream.Close();
    Console.WriteLine("Setup bytes saved: {0}", nLength);

    // Change settings with individual commands:

    // Set vertical scale and offset.
    myScope.DoCommand(":CHANnel1:SCALe 0.05");
    Console.WriteLine("Channel 1 vertical scale: {0}",
        myScope.DoQueryString(":CHANnel1:SCALe?"));

    myScope.DoCommand(":CHANnel1:OFFSet -1.5");
    Console.WriteLine("Channel 1 vertical offset: {0}",
        myScope.DoQueryString(":CHANnel1:OFFSet?"));
}

```



```

// Set horizontal scale and position.
myScope.DoCommand(":TIMEbase:SCALE 0.0002");
Console.WriteLine("Timebase scale: {0}",
    myScope.DoQueryString(":TIMEbase:SCALE?"));

myScope.DoCommand(":TIMEbase:POSition 0.0");
Console.WriteLine("Timebase position: {0}",
    myScope.DoQueryString(":TIMEbase:POSition?"));

// Set the acquisition type (NORMAL, PEAK, AVERAGE, or HRESOLUTION
).
myScope.DoCommand(":ACQUIRE:TYPE NORMAL");
Console.WriteLine("Acquire type: {0}",
    myScope.DoQueryString(":ACQUIRE:TYPE?"));

// Or, configure by loading a previously saved setup.
byte[] dataArray;
int nBytesWritten;

// Read setup string from file.
strPath = "c:\\scope\\config\\setup.stp";
dataArray = File.ReadAllBytes(strPath);

// Restore setup string.
nBytesWritten = myScope.DoCommandIEEEBlock(":SYSTEM:SETup",
    dataArray);
Console.WriteLine("Setup bytes restored: {0}", nBytesWritten);

// Capture an acquisition using :DIGITIZE.
myScope.DoCommand(":DIGitize CHANNEL1");
}

/*
 * Analyze the captured waveform.
 * -----
 */
private static void Analyze()
{
    byte[] resultsArray; // Results array.
    int nLength; // Number of bytes returned from instrument.
    string strPath;

    // Make a couple of measurements.
    // -----
    myScope.DoCommand(":MEASure:SOURce CHANNEL1");
    Console.WriteLine("Measure source: {0}",
        myScope.DoQueryString(":MEASure:SOURce?"));

    double fResult;
    myScope.DoCommand(":MEASure:FREQuency");
    fResult = myScope.DoQueryNumber(":MEASure:FREQuency?");
    Console.WriteLine("Frequency: {0:F4} kHz", fResult / 1000);

    myScope.DoCommand(":MEASure:VAMplitude");
    fResult = myScope.DoQueryNumber(":MEASure:VAMplitude?");
    Console.WriteLine("Vertical amplitude: {0:F2} V", fResult);
}

```

```

// Download the screen image.
// -----
myScope.DoCommand(":HARDcopy:INKSaver OFF");

// Get the screen data.
nLength = myScope.DoQueryIEEEBlock(":DISPlay:DATA? PNG, COlor",
    out ResultsArray);

// Store the screen data to a file.
strPath = "c:\\scope\\data\\screen.png";
FileStream fStream = File.Open(strPath, FileMode.Create);
fStream.Write(ResultsArray, 0, nLength);
fStream.Close();
Console.WriteLine("Screen image ({0} bytes) written to {1}",
    nLength, strPath);

// Download waveform data.
// -----

// Set the waveform points mode.
myScope.DoCommand(":WAVEform:POINts:MODE RAW");
Console.WriteLine("Waveform points mode: {0}",
    myScope.DoQueryString(":WAVEform:POINts:MODE?"));

// Get the number of waveform points available.
myScope.DoCommand(":WAVEform:POINts 10240");
Console.WriteLine("Waveform points available: {0}",
    myScope.DoQueryString(":WAVEform:POINts?"));

// Set the waveform source.
myScope.DoCommand(":WAVEform:SOURce CHANnel1");
Console.WriteLine("Waveform source: {0}",
    myScope.DoQueryString(":WAVEform:SOURce?"));

// Choose the format of the data returned (WORD, BYTE, ASCII):
myScope.DoCommand(":WAVEform:FORMat BYTE");
Console.WriteLine("Waveform format: {0}",
    myScope.DoQueryString(":WAVEform:FORMat?"));

// Display the waveform settings:
double[] fResultsArray;
fResultsArray = myScope.DoQueryNumbers(":WAVEform:PREAmble?");

double fFormat = fResultsArray[0];
if (fFormat == 0.0)
{
    Console.WriteLine("Waveform format: BYTE");
}
else if (fFormat == 1.0)
{
    Console.WriteLine("Waveform format: WORD");
}
else if (fFormat == 2.0)
{
    Console.WriteLine("Waveform format: ASCii");
}

```

```

double fType = fResultsArray[1];
if (fType == 0.0)
{
    Console.WriteLine("Acquire type: NORMAl");
}
else if (fType == 1.0)
{
    Console.WriteLine("Acquire type: PEAK");
}
else if (fType == 2.0)
{
    Console.WriteLine("Acquire type: AVERAge");
}
else if (fType == 3.0)
{
    Console.WriteLine("Acquire type: HRESolution");
}

double fPoints = fResultsArray[2];
Console.WriteLine("Waveform points: {0:e}", fPoints);

double fCount = fResultsArray[3];
Console.WriteLine("Waveform average count: {0:e}", fCount);

double fXincrement = fResultsArray[4];
Console.WriteLine("Waveform X increment: {0:e}", fXincrement);

double fXorigin = fResultsArray[5];
Console.WriteLine("Waveform X origin: {0:e}", fXorigin);

double fXreference = fResultsArray[6];
Console.WriteLine("Waveform X reference: {0:e}", fXreference);

double fYincrement = fResultsArray[7];
Console.WriteLine("Waveform Y increment: {0:e}", fYincrement);

double fYorigin = fResultsArray[8];
Console.WriteLine("Waveform Y origin: {0:e}", fYorigin);

double fYreference = fResultsArray[9];
Console.WriteLine("Waveform Y reference: {0:e}", fYreference);

// Read waveform data.
nLength = myScope.DoQueryIEEEBlock(":WAVEform:DATA?",
    out ResultsArray);
Console.WriteLine("Number of data values: {0}", nLength);

// Set up output file:
strPath = "c:\\scope\\data\\waveform_data.csv";
if (File.Exists(strPath)) File.Delete(strPath);

// Open file for output.
StreamWriter writer = File.CreateText(strPath);

// Output waveform data in CSV format.
for (int i = 0; i < nLength - 1; i++)

```

```

        writer.WriteLine("{0:f9}, {1:f6}",
            fXorigin + ((float)i * fXincrement),
            (((float)ResultsArray[i] - fYreference) *
            fYincrement) + fYorigin);

    // Close output file.
    writer.Close();
    Console.WriteLine("Waveform format BYTE data written to {0}",
        strPath);
    }
}

class VisaInstrument
{
    private int m_nResourceManager;
    private int m_nSession;
    private string m_strVisaAddress;

    // Constructor.
    public VisaInstrument(string strVisaAddress)
    {
        // Save VISA address in member variable.
        m_strVisaAddress = strVisaAddress;

        // Open the default VISA resource manager.
        OpenResourceManager();

        // Open a VISA resource session.
        OpenSession();

        // Clear the interface.
        int nViStatus;
        nViStatus = visa32.viClear(m_nSession);
    }

    public void DoCommand(string strCommand)
    {
        // Send the command.
        VisaSendCommandOrQuery(strCommand);

        // Check for inst errors.
        CheckInstrumentErrors(strCommand);
    }

    public int DoCommandIEEEBlock(string strCommand,
        byte[] dataArray)
    {
        // Send the command to the device.
        string strCommandAndLength;
        int nViStatus, nLength, nBytesWritten;

        nLength = dataArray.Length;
        strCommandAndLength = String.Format("{0} #8%08d",
            strCommand);

        // Write first part of command to formatted I/O write buffer.
        nViStatus = visa32.viPrintf(m_nSession, strCommandAndLength,

```

```

        nLength);
    CheckVisaStatus(nViStatus);

    // Write the data to the formatted I/O write buffer.
    nViStatus = visa32.viBufWrite(m_nSession, dataArray, nLength,
        out nBytesWritten);
    CheckVisaStatus(nViStatus);

    // Check for inst errors.
    CheckInstrumentErrors(strCommand);

    return nBytesWritten;
}

public StringBuilder DoQueryString(string strQuery)
{
    // Send the query.
    VisaSendCommandOrQuery(strQuery);

    // Get the result string.
    StringBuilder strResults = new StringBuilder(1000);
    strResults = VisaGetResultString();

    // Check for inst errors.
    CheckInstrumentErrors(strQuery);

    // Return string results.
    return strResults;
}

public double DoQueryNumber(string strQuery)
{
    // Send the query.
    VisaSendCommandOrQuery(strQuery);

    // Get the result string.
    double fResults;
    fResults = VisaGetResultNumber();

    // Check for inst errors.
    CheckInstrumentErrors(strQuery);

    // Return string results.
    return fResults;
}

public double[] DoQueryNumbers(string strQuery)
{
    // Send the query.
    VisaSendCommandOrQuery(strQuery);

    // Get the result string.
    double[] fResultsArray;
    fResultsArray = VisaGetResultNumbers();

    // Check for inst errors.
    CheckInstrumentErrors(strQuery);
}

```

```

        // Return string results.
        return fResultsArray;
    }

    public int DoQueryIEEEBlock(string strQuery,
        out byte[] ResultsArray)
    {
        // Send the query.
        VisaSendCommandOrQuery(strQuery);

        // Get the result string.
        int length; // Number of bytes returned from instrument.
        length = VisaGetResultIEEEBlock(out ResultsArray);

        // Check for inst errors.
        CheckInstrumentErrors(strQuery);

        // Return string results.
        return length;
    }

    private void VisaSendCommandOrQuery(string strCommandOrQuery)
    {
        // Send command or query to the device.
        string strWithNewline;
        strWithNewline = String.Format("{0}\n", strCommandOrQuery);
        int nViStatus;
        nViStatus = visa32.viPrintf(m_nSession, strWithNewline);
        CheckVisaStatus(nViStatus);
    }

    private StringBuilder VisaGetResultString()
    {
        StringBuilder strResults = new StringBuilder(1000);

        // Read return value string from the device.
        int nViStatus;
        nViStatus = visa32.viScanf(m_nSession, "%1000t", strResults);
        CheckVisaStatus(nViStatus);

        return strResults;
    }

    private double VisaGetResultNumber()
    {
        double fResults = 0;

        // Read return value string from the device.
        int nViStatus;
        nViStatus = visa32.viScanf(m_nSession, "%lf", out fResults);
        CheckVisaStatus(nViStatus);

        return fResults;
    }

    private double[] VisaGetResultNumbers()

```

```

{
    double[] fResultsArray;
    fResultsArray = new double[10];

    // Read return value string from the device.
    int nViStatus;
    nViStatus = visa32.viScanf(m_nSession, "%,10lf\n",
        fResultsArray);
    CheckVisaStatus(nViStatus);

    return fResultsArray;
}

private int VisaGetResultIEEEBlock(out byte[] ResultsArray)
{
    // Results array, big enough to hold a PNG.
    ResultsArray = new byte[300000];
    int length; // Number of bytes returned from instrument.

    // Set the default number of bytes that will be contained in
    // the ResultsArray to 300,000 (300kB).
    length = 300000;

    // Read return value string from the device.
    int nViStatus;
    nViStatus = visa32.viScanf(m_nSession, "%#b", ref length,
        ResultsArray);
    CheckVisaStatus(nViStatus);

    // Write and read buffers need to be flushed after IEEE block?
    nViStatus = visa32.viFlush(m_nSession, visa32.VI_WRITE_BUF);
    CheckVisaStatus(nViStatus);

    nViStatus = visa32.viFlush(m_nSession, visa32.VI_READ_BUF);
    CheckVisaStatus(nViStatus);

    return length;
}

private void CheckInstrumentErrors(string strCommand)
{
    // Check for instrument errors.
    StringBuilder strInstrumentError = new StringBuilder(1000);
    bool bFirstError = true;

    do // While not "0,No error"
    {
        VisaSendCommandOrQuery(":SYSTem:ERRor?");
        strInstrumentError = VisaGetResultString();

        if (!strInstrumentError.ToString().StartsWith("+0, "))
        {
            if (bFirstError)
            {
                Console.WriteLine("ERROR(s) for command '{0}': ",
                    strCommand);
                bFirstError = false;
            }
        }
    }
}

```

```

        }
        Console.WriteLine(strInstrumentError);
    }
} while (!strInstrumentError.ToString().StartsWith("+0,"));
}

private void OpenResourceManager()
{
    int nViStatus;
    nViStatus =
        visa32.viOpenDefaultRM(out this.m_nResourceManager);
    if (nViStatus < visa32.VI_SUCCESS)
        throw new
            ApplicationException("Failed to open Resource Manager");
}

private void OpenSession()
{
    int nViStatus;
    nViStatus = visa32.viOpen(this.m_nResourceManager,
        this.m_strVisaAddress, visa32.VI_NO_LOCK,
        visa32.VI_TMO_IMMEDIATE, out this.m_nSession);
    CheckVisaStatus(nViStatus);
}

public void SetTimeoutSeconds(int nSeconds)
{
    int nViStatus;
    nViStatus = visa32.viSetAttribute(this.m_nSession,
        visa32.VI_ATTR_TMO_VALUE, nSeconds * 1000);
    CheckVisaStatus(nViStatus);
}

public void CheckVisaStatus(int nViStatus)
{
    // If VISA error, throw exception.
    if (nViStatus < visa32.VI_SUCCESS)
    {
        StringBuilder strError = new StringBuilder(256);
        visa32.viStatusDesc(this.m_nResourceManager, nViStatus,
            strError);
        throw new ApplicationException(strError.ToString());
    }
}

public void Close()
{
    if (m_nSession != 0)
        visa32.viClose(m_nSession);
    if (m_nResourceManager != 0)
        visa32.viClose(m_nResourceManager);
}
}
}

```

VISA Example in Visual Basic .NET

To compile and run this example in Microsoft Visual Studio 2008:

- 1 Open Visual Studio.
- 2 Create a new Visual Basic, Windows, Console Application project.
- 3 Cut-and-paste the code that follows into the Visual Basic .NET source file.
- 4 Edit the program to use the VISA address of your oscilloscope.
- 5 Add Keysight's VISA header file to your project:
 - a Right-click the project you wish to modify (not the solution) in the Solution Explorer window of the Microsoft Visual Studio environment.
 - b Choose **Add** and then choose **Add Existing Item...**
 - c Navigate to the header file, visa32.vb (installed with Keysight IO Libraries Suite and found in the Program Files (x86)\IVI Foundation\VISA\WinNT\Include directory), select it, but *do not click the Open button*.
 - d Click the down arrow to the right of the **Add** button, and choose **Add as Link**.

You should now see the file underneath your project in the Solution Explorer. It will have a little arrow icon in its lower left corner, indicating that it is a link.
 - e Right-click the project again and choose **Properties**; then, select "InfiniiVision.VisaInstrumentApp" as the **Startup object**.
- 6 Build and run the program.

For more information, see the tutorial on using VISA in Microsoft .NET in the VISA Help that comes with Keysight IO Libraries Suite 17.

```
'
' Keysight VISA Example in Visual Basic .NET
' -----
' This program illustrates a few commonly-used programming
' features of your Keysight oscilloscope.
' -----

Imports System
Imports System.IO
Imports System.Text

Namespace InfiniiVision
  Class VisaInstrumentApp
    Private Shared myScope As VisaInstrument

    Public Shared Sub Main(ByVal args As String())
      Try
        myScope = _
          New VisaInstrument("USB0::0x0957::0x17A6::US50210029::0::INSTR
")
        myScope.SetTimeoutSeconds(10)
      End Try
    End Sub
  End Class
End Namespace
```

```

' Initialize - start from a known state.
Initialize()

' Capture data.
Capture()

' Analyze the captured waveform.
Analyze()

Catch err As System.ApplicationException
    Console.WriteLine("*** VISA Error Message : " + err.Message)
Catch err As System.SystemException
    Console.WriteLine("*** System Error Message : " + err.Message)
Catch err As System.Exception
    Debug.Fail("Unexpected Error")
    Console.WriteLine("*** Unexpected Error : " + err.Message)
End Try
End Sub

'
' Initialize the oscilloscope to a known state.
' -----

Private Shared Sub Initialize()
    Dim strResults As StringBuilder

    ' Get and display the device's *IDN? string.
    strResults = myScope.DoQueryString("*IDN?")
    Console.WriteLine("*IDN? result is: {0}", strResults)

    ' Clear status and load the default setup.
    myScope.DoCommand("*CLS")
    myScope.DoCommand("*RST")

End Sub

'
' Capture the waveform.
' -----

Private Shared Sub Capture()

    ' Use auto-scale to automatically configure oscilloscope.
    myScope.DoCommand(":AUToscale")

    ' Set trigger mode (EDGE, PULSe, PATtern, etc., and input source.
    myScope.DoCommand(":TRIGger:MODE EDGE")
    Console.WriteLine("Trigger mode: {0}", _
        myScope.DoQueryString(":TRIGger:MODE?"))

    ' Set EDGE trigger parameters.
    myScope.DoCommand(":TRIGger:EDGE:SOURce CHANnel1")
    Console.WriteLine("Trigger edge source: {0}", _
        myScope.DoQueryString(":TRIGger:EDGE:SOURce?"))

    myScope.DoCommand(":TRIGger:EDGE:LEVel 1.5")
    Console.WriteLine("Trigger edge level: {0}", _

```

```

myScope.DoQueryString(":TRIGger:EDGE:LEVel?")

myScope.DoCommand(":TRIGger:EDGE:SLOPe POSitive")
Console.WriteLine("Trigger edge slope: {0}", _
    myScope.DoQueryString(":TRIGger:EDGE:SLOPe?"))

' Save oscilloscope configuration.
Dim ResultsArray As Byte() ' Results array.
Dim nLength As Integer ' Number of bytes returned from inst.
Dim strPath As String
Dim fStream As FileStream

' Query and read setup string.
nLength = myScope.DoQueryIEEEBlock(":SYSTem:SETUp?", _
    ResultsArray)

' Write setup string to file.
strPath = "c:\scope\config\setup.stp"
fStream = File.Open(strPath, FileMode.Create)
fStream.Write(ResultsArray, 0, nLength)
fStream.Close()
Console.WriteLine("Setup bytes saved: {0}", nLength)

' Change settings with individual commands:

' Set vertical scale and offset.
myScope.DoCommand(":CHANnel1:SCALe 0.05")
Console.WriteLine("Channel 1 vertical scale: {0}", _
    myScope.DoQueryString(":CHANnel1:SCALe?"))

myScope.DoCommand(":CHANnel1:OFFSet -1.5")
Console.WriteLine("Channel 1 vertical offset: {0}", _
    myScope.DoQueryString(":CHANnel1:OFFSet?"))

' Set horizontal scale and position.
myScope.DoCommand(":TIMebase:SCALe 0.0002")
Console.WriteLine("Timebase scale: {0}", _
    myScope.DoQueryString(":TIMebase:SCALe?"))

myScope.DoCommand(":TIMebase:POSition 0.0")
Console.WriteLine("Timebase position: {0}", _
    myScope.DoQueryString(":TIMebase:POSition?"))

' Set the acquisition type (NORMal, PEAK, AVERAge, or HRESolution)

myScope.DoCommand(":ACQuire:TYPE NORMal")
Console.WriteLine("Acquire type: {0}", _
    myScope.DoQueryString(":ACQuire:TYPE?"))

' Or, configure by loading a previously saved setup.
Dim dataArray As Byte()
Dim nBytesWritten As Integer

' Read setup string from file.
strPath = "c:\scope\config\setup.stp"
dataArray = File.ReadAllBytes(strPath)

```

```

' Restore setup string.
nBytesWritten = myScope.DoCommandIEEEBlock(":SYSTem:SETup", _
    dataArray)
Console.WriteLine("Setup bytes restored: {0}", nBytesWritten)

' Capture an acquisition using :DIGitize.
myScope.DoCommand(":DIGitize CHANnel1")

End Sub

'
' Analyze the captured waveform.
' -----

Private Shared Sub Analyze()

    Dim fResult As Double
    Dim ResultsArray As Byte() ' Results array.
    Dim nLength As Integer ' Number of bytes returned from inst.
    Dim strPath As String

    ' Make a couple of measurements.
    ' -----
    myScope.DoCommand(":MEASure:SOURce CHANnel1")
    Console.WriteLine("Measure source: {0}", _
        myScope.DoQueryString(":MEASure:SOURce?"))

    myScope.DoCommand(":MEASure:FREQuency")
    fResult = myScope.DoQueryNumber(":MEASure:FREQuency?")
    Console.WriteLine("Frequency: {0:F4} kHz", fResult / 1000)

    myScope.DoCommand(":MEASure:VAMplitude")
    fResult = myScope.DoQueryNumber(":MEASure:VAMplitude?")
    Console.WriteLine("Vertical amplitude: {0:F2} V", fResult)

    ' Download the screen image.
    ' -----
    myScope.DoCommand(":HARDcopy:INKSaver OFF")

    ' Get the screen data.
    nLength = myScope.DoQueryIEEEBlock(":DISPlay:DATA? PNG, COLor", _
        ResultsArray)

    ' Store the screen data to a file.
    strPath = "c:\scope\data\screen.png"
    Dim fStream As FileStream
    fStream = File.Open(strPath, FileMode.Create)
    fStream.Write(ResultsArray, 0, nLength)
    fStream.Close()
    Console.WriteLine("Screen image ({0} bytes) written to {1}", _
        nLength, strPath)

    ' Download waveform data.
    ' -----

    ' Set the waveform points mode.
    myScope.DoCommand(":WAVEform:POINTs:MODE RAW")

```

```

Console.WriteLine("Waveform points mode: {0}", _
    myScope.DoQueryString(":WAVEform:POINTs:MODE?"))

' Get the number of waveform points available.
myScope.DoCommand(":WAVEform:POINTs 10240")
Console.WriteLine("Waveform points available: {0}", _
    myScope.DoQueryString(":WAVEform:POINTs?"))

' Set the waveform source.
myScope.DoCommand(":WAVEform:SOURce CHANnel1")
Console.WriteLine("Waveform source: {0}", _
    myScope.DoQueryString(":WAVEform:SOURce?"))

' Choose the format of the data returned (WORD, BYTE, ASCII):
myScope.DoCommand(":WAVEform:FORMat BYTE")
Console.WriteLine("Waveform format: {0}", _
    myScope.DoQueryString(":WAVEform:FORMat?"))

' Display the waveform settings:
Dim fResultsArray As Double()
fResultsArray = myScope.DoQueryNumbers(":WAVEform:PREAmble?")

Dim fFormat As Double = fResultsArray(0)
If fFormat = 0 Then
    Console.WriteLine("Waveform format: BYTE")
ElseIf fFormat = 1 Then
    Console.WriteLine("Waveform format: WORD")
ElseIf fFormat = 2 Then
    Console.WriteLine("Waveform format: ASCii")
End If

Dim fType As Double = fResultsArray(1)
If fType = 0 Then
    Console.WriteLine("Acquire type: NORMAl")
ElseIf fType = 1 Then
    Console.WriteLine("Acquire type: PEAK")
ElseIf fType = 2 Then
    Console.WriteLine("Acquire type: AVERAge")
ElseIf fType = 3 Then
    Console.WriteLine("Acquire type: HRESolution")
End If

Dim fPoints As Double = fResultsArray(2)
Console.WriteLine("Waveform points: {0:e}", fPoints)

Dim fCount As Double = fResultsArray(3)
Console.WriteLine("Waveform average count: {0:e}", fCount)

Dim fXincrement As Double = fResultsArray(4)
Console.WriteLine("Waveform X increment: {0:e}", fXincrement)

Dim fXorigin As Double = fResultsArray(5)
Console.WriteLine("Waveform X origin: {0:e}", fXorigin)

Dim fXreference As Double = fResultsArray(6)
Console.WriteLine("Waveform X reference: {0:e}", fXreference)

```

```

Dim fYincrement As Double = fResultsArray(7)
Console.WriteLine("Waveform Y increment: {0:e}", fYincrement)

Dim fYorigin As Double = fResultsArray(8)
Console.WriteLine("Waveform Y origin: {0:e}", fYorigin)

Dim fYreference As Double = fResultsArray(9)
Console.WriteLine("Waveform Y reference: {0:e}", fYreference)

' Get the waveform data.
nLength = myScope.DoQueryIEEEBlock(":WAVEform:DATA?", _
    ResultsArray)
Console.WriteLine("Number of data values: {0}", nLength)

' Set up output file:
strPath = "c:\scope\data\waveform_data.csv"
If File.Exists(strPath) Then
    File.Delete(strPath)
End If

' Open file for output.
Dim writer As StreamWriter = File.CreateText(strPath)

' Output waveform data in CSV format.
For index As Integer = 0 To nLength - 1
    ' Write time value, voltage value.
    writer.WriteLine("{0:f9}, {1:f6}", _
        fXorigin + (CSng(index) * fXincrement), _
        ((CSng(ResultsArray(index)) - fYreference) _
        * fYincrement) + fYorigin)
Next

' Close output file.
writer.Close()
Console.WriteLine("Waveform format BYTE data written to {0}", _
    strPath)

End Sub

End Class

Class VisaInstrument
Private m_nResourceManager As Integer
Private m_nSession As Integer
Private m_strVisaAddress As String

' Constructor.
Public Sub New(ByVal strVisaAddress As String)
    ' Save VISA address in member variable.
    m_strVisaAddress = strVisaAddress

    ' Open the default VISA resource manager.
    OpenResourceManager()

    ' Open a VISA resource session.
    OpenSession()

```

```

    ' Clear the interface.
    Dim nViStatus As Integer
    nViStatus = visa32.viClear(m_nSession)
End Sub

Public Sub DoCommand(ByVal strCommand As String)
    ' Send the command.
    VisaSendCommandOrQuery(strCommand)

    ' Check for inst errors.
    CheckInstrumentErrors(strCommand)

End Sub

Public Function DoCommandIEEEBlock(ByVal strCommand As String, _
    ByVal dataArray As Byte()) As Integer

    ' Send the command to the device.
    Dim strCommandAndLength As String
    Dim nViStatus As Integer
    Dim nLength As Integer
    Dim nBytesWritten As Integer

    nLength = dataArray.Length
    strCommandAndLength = [String].Format("{0} #8{1:D8}", _
        strCommand, nLength)

    ' Write first part of command to formatted I/O write buffer.
    nViStatus = visa32.viPrintf(m_nSession, strCommandAndLength)
    CheckVisaStatus(nViStatus)

    ' Write the data to the formatted I/O write buffer.
    nViStatus = visa32.viBufWrite(m_nSession, dataArray, nLength, _
        nBytesWritten)
    CheckVisaStatus(nViStatus)

    ' Check for inst errors.
    CheckInstrumentErrors(strCommand)

    Return nBytesWritten
End Function

Public Function DoQueryString(ByVal strQuery As String) _
    As StringBuilder
    ' Send the query.
    VisaSendCommandOrQuery(strQuery)

    ' Get the result string.
    Dim strResults As New StringBuilder(1000)
    strResults = VisaGetResultString()

    ' Check for inst errors.
    CheckInstrumentErrors(strQuery)

    ' Return string results.
    Return strResults
End Function

```

```

Public Function DoQueryNumber(ByVal strQuery As String) As Double
    ' Send the query.
    VisaSendCommandOrQuery(strQuery)

    ' Get the result string.
    Dim fResults As Double
    fResults = VisaGetResultNumber()

    ' Check for inst errors.
    CheckInstrumentErrors(strQuery)

    ' Return string results.
    Return fResults
End Function

Public Function DoQueryNumbers(ByVal strQuery As String) _
    As Double()
    ' Send the query.
    VisaSendCommandOrQuery(strQuery)

    ' Get the result string.
    Dim fResultsArray As Double()
    fResultsArray = VisaGetResultNumbers()

    ' Check for instrument errors (another command and result).
    CheckInstrumentErrors(strQuery)

    ' Return string results.
    Return fResultsArray
End Function

Public Function DoQueryIEEEBlock(ByVal strQuery As String, _
    ByRef ResultsArray As Byte()) As Integer
    ' Send the query.
    VisaSendCommandOrQuery(strQuery)

    ' Get the result string.
    System.Threading.Thread.Sleep(2000) ' Delay before reading data.
    Dim length As Integer
    ' Number of bytes returned from instrument.
    length = VisaGetResultIEEEBlock(ResultsArray)

    ' Check for inst errors.
    CheckInstrumentErrors(strQuery)

    ' Return string results.
    Return length
End Function

Private Sub VisaSendCommandOrQuery(ByVal strCommandOrQuery _
    As String)
    ' Send command or query to the device.
    Dim strWithNewline As String
    strWithNewline = [String].Format("{0}" & Chr(10) & "", _
        strCommandOrQuery)
    Dim nViStatus As Integer

```



```

    nViStatus = visa32.viPrintf(m_nSession, strWithNewline)
    CheckVisaStatus(nViStatus)
End Sub

Private Function VisaGetResultString() As StringBuilder
    Dim strResults As New StringBuilder(1000)

    ' Read return value string from the device.
    Dim nViStatus As Integer
    nViStatus = visa32.viScanf(m_nSession, "%1000t", strResults)
    CheckVisaStatus(nViStatus)

    Return strResults
End Function

Private Function VisaGetResultNumber() As Double
    Dim fResults As Double = 0

    ' Read return value string from the device.
    Dim nViStatus As Integer
    nViStatus = visa32.viScanf(m_nSession, "%lf", fResults)
    CheckVisaStatus(nViStatus)

    Return fResults
End Function

Private Function VisaGetResultNumbers() As Double()
    Dim fResultsArray As Double()
    fResultsArray = New Double(9) {}

    ' Read return value string from the device.
    Dim nViStatus As Integer
    nViStatus = visa32.viScanf(m_nSession, _
        "% ,10lf" & Chr(10) & "", fResultsArray)
    CheckVisaStatus(nViStatus)

    Return fResultsArray
End Function

Private Function VisaGetResultIEEEBlock(ByRef ResultsArray _
    As Byte()) As Integer
    ' Results array, big enough to hold a PNG.
    ResultsArray = New Byte(299999) {}
    Dim length As Integer
    ' Number of bytes returned from instrument.
    ' Set the default number of bytes that will be contained in
    ' the ResultsArray to 300,000 (300kB).
    length = 300000

    ' Read return value string from the device.
    Dim nViStatus As Integer
    nViStatus = visa32.viScanf(m_nSession, "%#b", length, _
        ResultsArray)
    CheckVisaStatus(nViStatus)

    ' Write and read buffers need to be flushed after IEEE block?
    nViStatus = visa32.viFlush(m_nSession, visa32.VI_WRITE_BUF)

```

```

    CheckVisaStatus(nViStatus)

    nViStatus = visa32.viFlush(m_nSession, visa32.VI_READ_BUF)
    CheckVisaStatus(nViStatus)

    Return length
End Function

Private Sub CheckInstrumentErrors(ByVal strCommand As String)
    ' Check for instrument errors.
    Dim strInstrumentError As New StringBuilder(1000)
    Dim bFirstError As Boolean = True
    Do ' While not "0,No error"
        VisaSendCommandOrQuery(":SYSTEM:ERROR?")
        strInstrumentError = VisaGetResultString()

        If Not strInstrumentError.ToString().StartsWith("+0,") Then
            If bFirstError Then
                Console.WriteLine("ERROR(s) for command '{0}': ", _
                    strCommand)
                bFirstError = False
            End If
            Console.Write(strInstrumentError)
        End If
    Loop While Not strInstrumentError.ToString().StartsWith("+0,")
End Sub

Private Sub OpenResourceManager()
    Dim nViStatus As Integer
    nViStatus = visa32.viOpenDefaultRM(Me.m_nResourceManager)
    If nViStatus < visa32.VI_SUCCESS Then
        Throw New _
            ApplicationException("Failed to open Resource Manager")
    End If
End Sub

Private Sub OpenSession()
    Dim nViStatus As Integer
    nViStatus = visa32.viOpen(Me.m_nResourceManager, _
        Me.m_strVisaAddress, visa32.VI_NO_LOCK, _
        visa32.VI_TMO_IMMEDIATE, Me.m_nSession)
    CheckVisaStatus(nViStatus)
End Sub

Public Sub SetTimeoutSeconds(ByVal nSeconds As Integer)
    Dim nViStatus As Integer
    nViStatus = visa32.viSetAttribute(Me.m_nSession, _
        visa32.VI_ATTR_TMO_VALUE, nSeconds * 1000)
    CheckVisaStatus(nViStatus)
End Sub

Public Sub CheckVisaStatus(ByVal nViStatus As Integer)
    ' If VISA error, throw exception.
    If nViStatus < visa32.VI_SUCCESS Then
        Dim strError As New StringBuilder(256)
        visa32.viStatusDesc(Me.m_nResourceManager, nViStatus, strError)
        Throw New ApplicationException(strError.ToString())
    End If
End Sub

```

```

    End If
End Sub

Public Sub Close()
    If m_nSession <> 0 Then
        visa32.viClose(m_nSession)
    End If
    If m_nResourceManager <> 0 Then
        visa32.viClose(m_nResourceManager)
    End If
End Sub
End Class
End Namespace

```

VISA Example in Python (PyVISA 1.5 and older)

You can use the Python programming language with the PyVISA package to control Keysight Infiniium Series oscilloscopes.

The Python language and PyVISA package can be downloaded from the web at <http://www.python.org/> and <http://pyvisa.sourceforge.net/>, respectively.

To run this example with Python and PyVISA:

- 1 Cut-and-paste the code that follows into a file named "example.py".
- 2 Edit the program to use the VISA address of your oscilloscope.
- 3 If "python.exe" can be found via your PATH environment variable, open a Command Prompt window; then, change to the folder that contains the "example.py" file, and enter:

```

python example.py

# *****
# This program illustrates a few commonly-used programming
# features of your Keysight oscilloscope.
# *****

# Import modules.
# -----
import visa
import string
import struct
import sys

# Global variables (booleans: 0 = False, 1 = True).
# -----
debug = 0

# =====
# Initialize:
# =====
def initialize():

    # Get and display the device's *IDN? string.

```

```

idn_string = do_query_string("*IDN?")
print "Identification string: '%s'" % idn_string

# Clear status and load the default setup.
do_command("*CLS")
do_command("*RST")

# =====
# Capture:
# =====
def capture():

    # Use auto-scale to automatically set up oscilloscope.
    print "Autoscale."
    do_command(":AUToscale")

    # Set trigger mode.
    do_command(":TRIGger:MODE EDGE")
    qresult = do_query_string(":TRIGger:MODE?")
    print "Trigger mode: %s" % qresult

    # Set EDGE trigger parameters.
    do_command(":TRIGger:EDGE:SOURce CHANnel1")
    qresult = do_query_string(":TRIGger:EDGE:SOURce?")
    print "Trigger edge source: %s" % qresult

    do_command(":TRIGger:EDGE:LEVel 1.5")
    qresult = do_query_string(":TRIGger:EDGE:LEVel?")
    print "Trigger edge level: %s" % qresult

    do_command(":TRIGger:EDGE:SLOPe POSitive")
    qresult = do_query_string(":TRIGger:EDGE:SLOPe?")
    print "Trigger edge slope: %s" % qresult

    # Save oscilloscope setup.
    sSetup = do_query_string(":SYSTem:SETup?")
    sSetup = get_definite_length_block_data(sSetup)

    f = open("setup.stp", "wb")
    f.write(sSetup)
    f.close()
    print "Setup bytes saved: %d" % len(sSetup)

    # Change oscilloscope settings with individual commands:

    # Set vertical scale and offset.
    do_command(":CHANnel1:SCALe 0.05")
    qresult = do_query_values(":CHANnel1:SCALe?")[0]
    print "Channel 1 vertical scale: %f" % qresult

    do_command(":CHANnel1:OFFSet -1.5")
    qresult = do_query_values(":CHANnel1:OFFSet?")[0]
    print "Channel 1 offset: %f" % qresult

    # Set horizontal scale and offset.
    do_command(":TIMEbase:SCALe 0.0002")

```

```

qresult = do_query_string(":TIMEbase:SCALE?")
print "Timebase scale: %s" % qresult

do_command(":TIMEbase:POSition 0.0")
qresult = do_query_string(":TIMEbase:POSition?")
print "Timebase position: %s" % qresult

# Set the acquisition type.
do_command(":ACQUIRE:TYPE NORMAL")
qresult = do_query_string(":ACQUIRE:TYPE?")
print "Acquire type: %s" % qresult

# Or, set up oscilloscope by loading a previously saved setup.
sSetup = ""
f = open("setup.stp", "rb")
sSetup = f.read()
f.close()
do_command(":SYSTEM:SETup #8%08d%s" % (len(sSetup), sSetup), hide_param
s=True)
print "Setup bytes restored: %d" % len(sSetup)

# Capture an acquisition using :DIGitize.
do_command(":DIGitize CHANnel1")

# =====
# Analyze:
# =====
def analyze():

    # Make measurements.
    # -----
    do_command(":MEASure:SOURce CHANnel1")
    qresult = do_query_string(":MEASure:SOURce?")
    print "Measure source: %s" % qresult

    do_command(":MEASure:FREQuency")
    qresult = do_query_string(":MEASure:FREQuency?")
    print "Measured frequency on channel 1: %s" % qresult

    do_command(":MEASure:VAMPlitude")
    qresult = do_query_string(":MEASure:VAMPlitude?")
    print "Measured vertical amplitude on channel 1: %s" % qresult

    # Download the screen image.
    # -----
    do_command(":HARDcopy:INKSaver OFF")

    sDisplay = do_query_string(":DISPlay:DATA? PNG, COLor")
    sDisplay = get_definite_length_block_data(sDisplay)

    # Save display data values to file.
    f = open("screen_image.png", "wb")
    f.write(sDisplay)
    f.close()
    print "Screen image written to screen_image.png."

```

```

# Download waveform data.
# -----

# Set the waveform points mode.
do_command(":WAVEform:POINTs:MODE RAW")
qresult = do_query_string(":WAVEform:POINTs:MODE?")
print "Waveform points mode: %s" % qresult

# Get the number of waveform points available.
do_command(":WAVEform:POINTs 10240")
qresult = do_query_string(":WAVEform:POINTs?")
print "Waveform points available: %s" % qresult

# Set the waveform source.
do_command(":WAVEform:SOURce CHANnel1")
qresult = do_query_string(":WAVEform:SOURce?")
print "Waveform source: %s" % qresult

# Choose the format of the data returned:
do_command(":WAVEform:FORMat BYTE")
print "Waveform format: %s" % do_query_string(":WAVEform:FORMat?")

# Display the waveform settings from preamble:
wav_form_dict = {
    0 : "BYTE",
    1 : "WORD",
    4 : "ASCIi",
}
acq_type_dict = {
    0 : "NORMal",
    1 : "PEAK",
    2 : "AVERage",
    3 : "HRESolution",
}

preamble_string = do_query_string(":WAVEform:PREamble?")
(
    wav_form, acq_type, wfmpTs, avgcnt, x_increment, x_origin,
    x_reference, y_increment, y_origin, y_reference
) = string.split(preamble_string, ",")

print "Waveform format: %s" % wav_form_dict[int(wav_form)]
print "Acquire type: %s" % acq_type_dict[int(acq_type)]
print "Waveform points desired: %s" % wfmpTs
print "Waveform average count: %s" % avgcnt
print "Waveform X increment: %s" % x_increment
print "Waveform X origin: %s" % x_origin
print "Waveform X reference: %s" % x_reference # Always 0.
print "Waveform Y increment: %s" % y_increment
print "Waveform Y origin: %s" % y_origin
print "Waveform Y reference: %s" % y_reference

# Get numeric values for later calculations.
x_increment = do_query_values(":WAVEform:XINCrement?")[0]
x_origin = do_query_values(":WAVEform:XORigin?")[0]
y_increment = do_query_values(":WAVEform:YINCrement?")[0]
y_origin = do_query_values(":WAVEform:YORigin?")[0]

```

```

y_reference = do_query_values(":WAVEform:YREFERENCE?")[0]

# Get the waveform data.
sData = do_query_string(":WAVEform:DATA?")
sData = get_definite_length_block_data(sData)

# Unpack unsigned byte data.
values = struct.unpack("%dB" % len(sData), sData)
print "Number of data values: %d" % len(values)

# Save waveform data values to CSV file.
f = open("waveform_data.csv", "w")

for i in xrange(0, len(values) - 1):
    time_val = x_origin + (i * x_increment)
    voltage = ((values[i] - y_reference) * y_increment) + y_origin
    f.write("%E, %f\n" % (time_val, voltage))

f.close()
print "Waveform format BYTE data written to waveform_data.csv."

# =====
# Send a command and check for errors:
# =====
def do_command(command, hide_params=False):

    if hide_params:
        (header, data) = string.split(command, " ", 1)
        if debug:
            print "\nCmd = '%s'" % header
    else:
        if debug:
            print "\nCmd = '%s'" % command

    InfiniiVision.write("%s\n" % command)

    if hide_params:
        check_instrument_errors(header)
    else:
        check_instrument_errors(command)

# =====
# Send a query, check for errors, return string:
# =====
def do_query_string(query):
    if debug:
        print "Qys = '%s'" % query
    result = InfiniiVision.ask("%s\n" % query)
    check_instrument_errors(query)
    return result

# =====
# Send a query, check for errors, return values:
# =====

```

```

def do_query_values(query):
    if debug:
        print "Qyv = '%s'" % query
    results = InfiniiVision.ask_for_values("%s\n" % query)
    check_instrument_errors(query)
    return results

# =====
# Check for instrument errors:
# =====
def check_instrument_errors(command):

    while True:
        error_string = InfiniiVision.ask(":SYSTem:ERRor?\n")
        if error_string: # If there is an error string value.

            if error_string.find("+0,", 0, 3) == -1: # Not "No error".

                print "ERROR: %s, command: '%s'" % (error_string, command)
                print "Exited because of error."
                sys.exit(1)

            else: # "No error"
                break

        else: # :SYSTem:ERRor? should always return string.
            print "ERROR: :SYSTem:ERRor? returned nothing, command: '%s'" % comma
            print "Exited because of error."
            sys.exit(1)

# =====
# Returns data from definite-length block.
# =====
def get_definite_length_block_data(sBlock):

    # First character should be "#".
    pound = sBlock[0:1]
    if pound != "#":
        print "PROBLEM: Invalid binary block format, pound char is '%s'." % po
        print "Exited because of problem."
        sys.exit(1)

    # Second character is number of following digits for length value.
    digits = sBlock[1:2]

    # Get the data out of the block and return it.
    sData = sBlock[int(digits) + 2:]

    return sData

# =====
# Main program:

```



```

# =====
InfiniiVision = visa.instrument("TCPIP0::130.29.70.139::inst0::INSTR")
InfiniiVision.timeout = 15
InfiniiVision.term_chars = ""
InfiniiVision.clear()

# Initialize the oscilloscope, capture data, and analyze.
initialize()
capture()
analyze()

print "End of program."

```

VISA Example in Python (PyVISA 1.6 and newer)

You can use the Python programming language with the PyVISA package to control Keysight Infiniium Series oscilloscopes.

The Python language and PyVISA package can be downloaded from the web at <http://www.python.org/> and <http://pyvisa.readthedocs.org/>, respectively.

To run this example with Python and PyVISA:

- 1 Cut-and-paste the code that follows into a file named "example.py".
- 2 Edit the program to use the VISA address of your oscilloscope.
- 3 If "python.exe" can be found via your PATH environment variable, open a Command Prompt window; then, change to the folder that contains the "example.py" file, and enter:

```

python example.py

# *****
# This program illustrates a few commonly-used programming
# features of your Keysight oscilloscope.
# *****

# Import modules.
# -----
import visa
import string
import struct
import sys

# Global variables (booleans: 0 = False, 1 = True).
# -----
debug = 0

# =====
# Initialize:
# =====
def initialize():

    # Get and display the device's *IDN? string.

```

```

idn_string = do_query_string("*IDN?")
print "Identification string: '%s'" % idn_string

# Clear status and load the default setup.
do_command("*CLS")
do_command("*RST")

# =====
# Capture:
# =====
def capture():

    # Use auto-scale to automatically set up oscilloscope.
    print "Autoscale."
    do_command(":AUToscale")

    # Set trigger mode.
    do_command(":TRIGger:MODE EDGE")
    qresult = do_query_string(":TRIGger:MODE?")
    print "Trigger mode: %s" % qresult

    # Set EDGE trigger parameters.
    do_command(":TRIGger:EDGE:SOURce CHANnel1")
    qresult = do_query_string(":TRIGger:EDGE:SOURce?")
    print "Trigger edge source: %s" % qresult

    do_command(":TRIGger:EDGE:LEVel 1.5")
    qresult = do_query_string(":TRIGger:EDGE:LEVel?")
    print "Trigger edge level: %s" % qresult

    do_command(":TRIGger:EDGE:SLOPe POSitive")
    qresult = do_query_string(":TRIGger:EDGE:SLOPe?")
    print "Trigger edge slope: %s" % qresult

    # Save oscilloscope setup.
    sSetup = do_query_ieee_block(":SYSTem:SETup?")

    f = open("setup.stp", "wb")
    f.write(sSetup)
    f.close()
    print "Setup bytes saved: %d" % len(sSetup)

    # Change oscilloscope settings with individual commands:

    # Set vertical scale and offset.
    do_command(":CHANnel1:SCALe 0.05")
    qresult = do_query_string(":CHANnel1:SCALe?")
    print "Channel 1 vertical scale: %s" % qresult

    do_command(":CHANnel1:OFFSet -1.5")
    qresult = do_query_string(":CHANnel1:OFFSet?")
    print "Channel 1 offset: %s" % qresult

    # Set horizontal scale and offset.
    do_command(":TIMEbase:SCALe 0.0002")
    qresult = do_query_string(":TIMEbase:SCALe?")

```

```

print "Timebase scale: %s" % qresult

do_command(":TIMEbase:POSition 0.0")
qresult = do_query_string(":TIMEbase:POSition?")
print "Timebase position: %s" % qresult

# Set the acquisition type.
do_command(":ACQuire:TYPE NORMAL")
qresult = do_query_string(":ACQuire:TYPE?")
print "Acquire type: %s" % qresult

# Or, set up oscilloscope by loading a previously saved setup.
sSetup = ""
f = open("setup.stp", "rb")
sSetup = f.read()
f.close()
do_command_ieee_block(":SYSTem:SETup", sSetup)
print "Setup bytes restored: %d" % len(sSetup)

# Capture an acquisition using :DIGitize.
do_command(":DIGitize CHANnel1")

# =====
# Analyze:
# =====
def analyze():

    # Make measurements.
    # -----
    do_command(":MEASure:SOURce CHANnel1")
    qresult = do_query_string(":MEASure:SOURce?")
    print "Measure source: %s" % qresult

    do_command(":MEASure:FREQuency")
    qresult = do_query_string(":MEASure:FREQuency?")
    print "Measured frequency on channel 1: %s" % qresult

    do_command(":MEASure:VAMPlitude")
    qresult = do_query_string(":MEASure:VAMPlitude?")
    print "Measured vertical amplitude on channel 1: %s" % qresult

    # Download the screen image.
    # -----
    do_command(":HARDcopy:INKSaver OFF")

    sDisplay = do_query_ieee_block(":DISPlay:DATA? PNG, COLor")

    # Save display data values to file.
    f = open("screen_image.png", "wb")
    f.write(sDisplay)
    f.close()
    print "Screen image written to screen_image.png."

    # Download waveform data.
    # -----

```

```

# Set the waveform points mode.
do_command(":WAVEform:POINTs:MODE RAW")
qresult = do_query_string(":WAVEform:POINTs:MODE?")
print "Waveform points mode: %s" % qresult

# Get the number of waveform points available.
do_command(":WAVEform:POINTs 10240")
qresult = do_query_string(":WAVEform:POINTs?")
print "Waveform points available: %s" % qresult

# Set the waveform source.
do_command(":WAVEform:SOURce CHANnel1")
qresult = do_query_string(":WAVEform:SOURce?")
print "Waveform source: %s" % qresult

# Choose the format of the data returned:
do_command(":WAVEform:FORMat BYTE")
print "Waveform format: %s" % do_query_string(":WAVEform:FORMat?")

# Display the waveform settings from preamble:
wav_form_dict = {
    0 : "BYTE",
    1 : "WORD",
    4 : "AScii",
}
acq_type_dict = {
    0 : "NORMal",
    1 : "PEAK",
    2 : "AVERage",
    3 : "HRESolution",
}

preamble_string = do_query_string(":WAVEform:PREamble?")
(
    wav_form, acq_type, wfmppts, avgcnt, x_increment, x_origin,
    x_reference, y_increment, y_origin, y_reference
) = string.split(preamble_string, ",")

print "Waveform format: %s" % wav_form_dict[int(wav_form)]
print "Acquire type: %s" % acq_type_dict[int(acq_type)]
print "Waveform points desired: %s" % wfmppts
print "Waveform average count: %s" % avgcnt
print "Waveform X increment: %s" % x_increment
print "Waveform X origin: %s" % x_origin
print "Waveform X reference: %s" % x_reference # Always 0.
print "Waveform Y increment: %s" % y_increment
print "Waveform Y origin: %s" % y_origin
print "Waveform Y reference: %s" % y_reference

# Get numeric values for later calculations.
x_increment = do_query_number(":WAVEform:XINCrement?")
x_origin = do_query_number(":WAVEform:XORigin?")
y_increment = do_query_number(":WAVEform:YINCrement?")
y_origin = do_query_number(":WAVEform:YORigin?")
y_reference = do_query_number(":WAVEform:YREFerence?")

# Get the waveform data.

```

```

sData = do_query_ieee_block(":WAVEform:DATA?")

# Unpack unsigned byte data.
values = struct.unpack("%dB" % len(sData), sData)
print "Number of data values: %d" % len(values)

# Save waveform data values to CSV file.
f = open("waveform_data.csv", "w")

for i in xrange(0, len(values) - 1):
    time_val = x_origin + (i * x_increment)
    voltage = ((values[i] - y_reference) * y_increment) + y_origin
    f.write("%E, %f\n" % (time_val, voltage))

f.close()
print "Waveform format BYTE data written to waveform_data.csv."

# =====
# Send a command and check for errors:
# =====
def do_command(command, hide_params=False):

    if hide_params:
        (header, data) = string.split(command, " ", 1)
        if debug:
            print "\nCmd = '%s'" % header
    else:
        if debug:
            print "\nCmd = '%s'" % command

    InfiniiVision.write("%s" % command)

    if hide_params:
        check_instrument_errors(header)
    else:
        check_instrument_errors(command)

# =====
# Send a command and binary values and check for errors:
# =====
def do_command_ieee_block(command, values):
    if debug:
        print "Cmb = '%s'" % command
    InfiniiVision.write_binary_values("%s " % command, values, datatype='c'
)
    check_instrument_errors(command)

# =====
# Send a query, check for errors, return string:
# =====
def do_query_string(query):
    if debug:
        print "Qys = '%s'" % query
    result = InfiniiVision.query("%s" % query)

```

```

    check_instrument_errors(query)
    return result

# =====
# Send a query, check for errors, return floating-point value:
# =====
def do_query_number(query):
    if debug:
        print "Qyn = '%s'" % query
    results = InfiniiVision.query("%s" % query)
    check_instrument_errors(query)
    return float(results)

# =====
# Send a query, check for errors, return binary values:
# =====
def do_query_ieee_block(query):
    if debug:
        print "Qys = '%s'" % query
    result = InfiniiVision.query_binary_values("%s" % query, datatype='s')
    check_instrument_errors(query)
    return result[0]

# =====
# Check for instrument errors:
# =====
def check_instrument_errors(command):

    while True:
        error_string = InfiniiVision.query(":SYSTem:ERRor?")
        if error_string: # If there is an error string value.

            if error_string.find("+0", 0, 3) == -1: # Not "No error".

                print "ERROR: %s, command: '%s'" % (error_string, command)
                print "Exited because of error."
                sys.exit(1)

            else: # "No error"
                break

        else: # :SYSTem:ERRor? should always return string.
            print "ERROR: :SYSTem:ERRor? returned nothing, command: '%s'" % command
            print "Exited because of error."
            sys.exit(1)

# =====
# Main program:
# =====

rm = visa.ResourceManager()
InfiniiVision= rm.open_resource("TCPIP0::130.29.70.139::inst0::INSTR")

```

```
InfiniiVision.timeout = 15000
InfiniiVision.clear()

# Initialize the oscilloscope, capture data, and analyze.
initialize()
capture()
analyze()

print "End of program."
```

SICL Examples

- **"SICL Example in C"** on page 1480
- **"SICL Example in Visual Basic"** on page 1489

SICL Example in C

To compile and run this example in Microsoft Visual Studio 2008:

- 1 Open Visual Studio.
- 2 Create a new Visual C++, Win32, Win32 Console Application project.
- 3 In the Win32 Application Wizard, click **Next >**. Then, check **Empty project**, and click **Finish**.
- 4 Cut-and-paste the code that follows into a file named "example.c" in the project directory.
- 5 In Visual Studio 2008, right-click the Source Files folder, choose **Add > Add Existing Item...**, select the example.c file, and click **Add**.
- 6 Edit the program to use the SICL address of your oscilloscope.
- 7 Choose **Project > Properties....** In the Property Pages dialog, update these project settings:
 - a Under Configuration Properties, Linker, Input, add "sicl32.lib" to the Additional Dependencies field.
 - b Under Configuration Properties, C/C++, Code Generation, select Multi-threaded DLL for the Runtime Library field.
 - c Click **OK** to close the Property Pages dialog.
- 8 Add the include files and library files search paths:
 - a Choose **Tools > Options....**
 - b In the Options dialog, select **VC++ Directories** under Projects and Solutions.
 - c Show directories for **Include files**, and add the include directory (for example, Program Files\Keysight\IO Libraries Suite\include).
 - d Show directories for **Library files**, and add the library files directory (for example, Program Files\Keysight\IO Libraries Suite\lib).
 - e Click **OK** to close the Options dialog.
- 9 Build and run the program.

```

/*
 * Keysight SICL Example in C
 * -----
 * This program illustrates a few commonly-used programming
 * features of your Keysight oscilloscope.
 */

#include <stdio.h>                                /* For printf(). */

```



```

#include <string.h>          /* For strcpy(), strcat(). */
#include <time.h>           /* For clock(). */
#include <sicl.h>           /* Keysight SICL routines. */

#define SICL_ADDRESS       "usb0[2391::6054::US50210029::0]"
#define TIMEOUT           5000
#define IEEEBLOCK_SPACE   300000

/* Function prototypes */
void initialize(void);      /* Initialize to known state. */
void capture(void);        /* Capture the waveform. */
void analyze(void);        /* Analyze the captured waveform. */

void do_command(char *command); /* Send command. */
int do_command_ieeeblock(char *command); /* Command w/IEEE block. */
void do_query_string(char *query); /* Query for string. */
void do_query_number(char *query); /* Query for number. */
void do_query_numbers(char *query); /* Query for numbers. */
int do_query_ieeeblock(char *query); /* Query for IEEE block. */
void check_instrument_errors(); /* Check for inst errors. */

/* Global variables */
INST id; /* Device session ID. */
char str_result[256] = {0}; /* Result from do_query_string(). */
double num_result; /* Result from do_query_number(). */
unsigned char ieeeblock_data[IEEEBLOCK_SPACE]; /* Result from
do_query_ieeeblock(). */
double dbl_results[10]; /* Result from do_query_numbers(). */

/* Main Program
* ----- */
void main(void)
{
    /* Install a default SICL error handler that logs an error message
    * and exits. On Windows 98SE or Windows Me, view messages with
    * the SICL Message Viewer. For Windows 2000 or XP, use the Event
    * Viewer.
    */
    ionerror(I_ERROR_EXIT);

    /* Open a device session using the SICL_ADDRESS */
    id = iopen(SICL_ADDRESS);

    if (id == 0)
    {
        printf ("Oscilloscope iopen failed!\n");
    }
    else
    {
        printf ("Oscilloscope session opened!\n");
    }

    /* Initialize - start from a known state. */
    initialize();

    /* Capture data. */
    capture();

```

```

/* Analyze the captured waveform. */
analyze();

/* Close the device session to the instrument. */
fclose(id);
printf ("Program execution is complete...\n");

/* For WIN16 programs, call _siclcleanup before exiting to release
 * resources allocated by SICL for this application. This call is
 * a no-op for WIN32 programs.
 */
_siclcleanup();
}

/* Initialize the oscilloscope to a known state.
 * ----- */
void initialize (void)
{
/* Set the I/O timeout value for this session to 5 seconds. */
itimeout(id, TIMEOUT);

/* Clear the interface. */
iclear(id);

/* Get and display the device's *IDN? string. */
do_query_string("*IDN?");
printf("Oscilloscope *IDN? string: %s\n", str_result);

/* Clear status and load the default setup. */
do_command("*CLS");
do_command("*RST");
}

/* Capture the waveform.
 * ----- */
void capture (void)
{
int num_bytes;
FILE *fp;

/* Use auto-scale to automatically configure oscilloscope.
 * ----- */
do_command(":AUToscale");

/* Set trigger mode (EDGE, PULSe, PATtern, etc., and input source. */
do_command(":TRIGger:MODE EDGE");
do_query_string(":TRIGger:MODE?");
printf("Trigger mode: %s\n", str_result);

/* Set EDGE trigger parameters. */
do_command(":TRIGger:EDGE:SOURce CHANnel1");
do_query_string(":TRIGger:EDGE:SOURce?");
printf("Trigger edge source: %s\n", str_result);

do_command(":TRIGger:EDGE:LEVel 1.5");
do_query_string(":TRIGger:EDGE:LEVel?");
}

```

```

printf("Trigger edge level: %s\n", str_result);

do_command(":TRIGger:EDGE:SLOPe POSitive");
do_query_string(":TRIGger:EDGE:SLOPe?");
printf("Trigger edge slope: %s\n", str_result);

/* Save oscilloscope configuration.
 * ----- */

/* Read system setup. */
num_bytes = do_query_ieeeblock(":SYSTem:SETup?");
printf("Read setup string query (%d bytes).\n", num_bytes);

/* Write setup string to file. */
fp = fopen ("c:\\scope\\config\\setup.stp", "wb");
num_bytes = fwrite(ieeeblock_data, sizeof(unsigned char), num_bytes,
    fp);
fclose (fp);
printf("Wrote setup string (%d bytes) to ", num_bytes);
printf("c:\\scope\\config\\setup.stp.\n");

/* Change settings with individual commands:
 * ----- */

/* Set vertical scale and offset. */
do_command(":CHANnel1:SCALe 0.05");
do_query_string(":CHANnel1:SCALe?");
printf("Channel 1 vertical scale: %s\n", str_result);

do_command(":CHANnel1:OFFSet -1.5");
do_query_string(":CHANnel1:OFFSet?");
printf("Channel 1 offset: %s\n", str_result);

/* Set horizontal scale and position. */
do_command(":TIMEbase:SCALe 0.0002");
do_query_string(":TIMEbase:SCALe?");
printf("Timebase scale: %s\n", str_result);

do_command(":TIMEbase:POSition 0.0");
do_query_string(":TIMEbase:POSition?");
printf("Timebase position: %s\n", str_result);

/* Set the acquisition type (NORMAL, PEAK, AVERage, or HRESolution). *
/
do_command(":ACQuire:TYPE NORMal");
do_query_string(":ACQuire:TYPE?");
printf("Acquire type: %s\n", str_result);

/* Or, configure by loading a previously saved setup.
 * ----- */

/* Read setup string from file. */
fp = fopen ("c:\\scope\\config\\setup.stp", "rb");
num_bytes = fread (ieeeblock_data, sizeof(unsigned char),
    IEEEBLOCK_SPACE, fp);
fclose (fp);
printf("Read setup string (%d bytes) from file ", num_bytes);

```

```

printf("c:\\scope\\config\\setup.stp.\n");

/* Restore setup string. */
num_bytes = do_command_ieeeblock(":SYSTEM:SETup", num_bytes);
printf("Restored setup string (%d bytes).\n", num_bytes);

/* Capture an acquisition using :DIGitize.
 * ----- */
do_command(":DIGitize CHANnel1");
}

/* Analyze the captured waveform.
 * ----- */
void analyze (void)
{
    double wav_format;
    double acq_type;
    double wav_points;
    double avg_count;
    double x_increment;
    double x_origin;
    double x_reference;
    double y_increment;
    double y_origin;
    double y_reference;

    FILE *fp;
    int num_bytes; /* Number of bytes returned from instrument. */
    int i;

    /* Make a couple of measurements.
     * ----- */
    do_command(":MEASure:SOURce CHANnel1");
    do_query_string(":MEASure:SOURce?");
    printf("Measure source: %s\n", str_result);

    do_command(":MEASure:FREQuency");
    do_query_number(":MEASure:FREQuency?");
    printf("Frequency: %.4f kHz\n", num_result / 1000);

    do_command(":MEASure:VAMPlitude");
    do_query_number(":MEASure:VAMPlitude?");
    printf("Vertical amplitude: %.2f V\n", num_result);

    /* Download the screen image.
     * ----- */
    do_command(":HARDcopy:INKSaver OFF");

    /* Read screen image. */
    num_bytes = do_query_ieeeblock(":DISPlay:DATA? PNG, COLor");
    printf("Screen image bytes: %d\n", num_bytes);

    /* Write screen image bytes to file. */
    fp = fopen ("c:\\scope\\data\\screen.png", "wb");
    num_bytes = fwrite(ieeeblock_data, sizeof(unsigned char), num_bytes,
        fp);
    fclose (fp);
}

```

```

printf("Wrote screen image (%d bytes) to ", num_bytes);
printf("c:\\scope\\data\\screen.png.\n");

/* Download waveform data.
 * ----- */

/* Set the waveform points mode. */
do_command(":WAVEform:POINTs:MODE RAW");
do_query_string(":WAVEform:POINTs:MODE?");
printf("Waveform points mode: %s\n", str_result);

/* Get the number of waveform points available. */
do_command(":WAVEform:POINTs 10240");
do_query_string(":WAVEform:POINTs?");
printf("Waveform points available: %s\n", str_result);

/* Set the waveform source. */
do_command(":WAVEform:SOURce CHANnel1");
do_query_string(":WAVEform:SOURce?");
printf("Waveform source: %s\n", str_result);

/* Choose the format of the data returned (WORD, BYTE, ASCII): */
do_command(":WAVEform:FORMat BYTE");
do_query_string(":WAVEform:FORMat?");
printf("Waveform format: %s\n", str_result);

/* Display the waveform settings: */
do_query_numbers(":WAVEform:PREAmble?");

wav_format = dbl_results[0];
if (wav_format == 0.0)
{
    printf("Waveform format: BYTE\n");
}
else if (wav_format == 1.0)
{
    printf("Waveform format: WORD\n");
}
else if (wav_format == 2.0)
{
    printf("Waveform format: ASCii\n");
}

acq_type = dbl_results[1];
if (acq_type == 0.0)
{
    printf("Acquire type: NORMal\n");
}
else if (acq_type == 1.0)
{
    printf("Acquire type: PEAK\n");
}
else if (acq_type == 2.0)
{
    printf("Acquire type: AVERage\n");
}
else if (acq_type == 3.0)

```

```

    {
        printf("Acquire type: HRESolution\n");
    }

    wav_points = dbl_results[2];
    printf("Waveform points: %e\n", wav_points);

    avg_count = dbl_results[3];
    printf("Waveform average count: %e\n", avg_count);

    x_increment = dbl_results[4];
    printf("Waveform X increment: %e\n", x_increment);

    x_origin = dbl_results[5];
    printf("Waveform X origin: %e\n", x_origin);

    x_reference = dbl_results[6];
    printf("Waveform X reference: %e\n", x_reference);

    y_increment = dbl_results[7];
    printf("Waveform Y increment: %e\n", y_increment);

    y_origin = dbl_results[8];
    printf("Waveform Y origin: %e\n", y_origin);

    y_reference = dbl_results[9];
    printf("Waveform Y reference: %e\n", y_reference);

    /* Read waveform data. */
    num_bytes = do_query_ieeeblock(":WAVEform:DATA?");
    printf("Number of data values: %d\n", num_bytes);

    /* Open file for output. */
    fp = fopen("c:\\scope\\data\\waveform_data.csv", "wb");

    /* Output waveform data in CSV format. */
    for (i = 0; i < num_bytes - 1; i++)
    {
        /* Write time value, voltage value. */
        fprintf(fp, "%9f, %6f\n",
            x_origin + ((float)i * x_increment),
            (((float)ieeeblock_data[i] - y_reference) * y_increment)
            + y_origin);
    }

    /* Close output file. */
    fclose(fp);
    printf("Waveform format BYTE data written to ");
    printf("c:\\scope\\data\\waveform_data.csv.\n");
}

/* Send a command to the instrument.
 * ----- */
void do_command(command)
char *command;
{
    char message[80];

```

```

        strcpy(message, command);
        strcat(message, "\n");
        iprintf(id, message);

        check_instrument_errors();
    }

/* Command with IEEE definite-length block.
 * ----- */
int do_command_ieeeblock(command, num_bytes)
char *command;
int num_bytes;
{
    char message[80];
    int data_length;

    strcpy(message, command);
    strcat(message, " #8%08d");
    iprintf(id, message, num_bytes);
    ifwrite(id, ieeeblock_data, num_bytes, 1, &data_length);

    check_instrument_errors();

    return(data_length);
}

/* Query for a string result.
 * ----- */
void do_query_string(query)
char *query;
{
    char message[80];

    strcpy(message, query);
    strcat(message, "\n");
    iprintf(id, message);

    iscanf(id, "%t\n", str_result);

    check_instrument_errors();
}

/* Query for a number result.
 * ----- */
void do_query_number(query)
char *query;
{
    char message[80];

    strcpy(message, query);
    strcat(message, "\n");
    iprintf(id, message);

    iscanf(id, "%lf", &num_result);

    check_instrument_errors();
}

```

```

}

/* Query for numbers result.
 * ----- */
void do_query_numbers(query)
char *query;
{
    char message[80];

    strcpy(message, query);
    strcat(message, "\n");
    fprintf(id, message);

    iscanf(id, "%,10lf\n", dbl_results);

    check_instrument_errors();
}

/* Query for an IEEE definite-length block result.
 * ----- */
int do_query_ieeeblock(query)
char *query;
{
    char message[80];
    int data_length;

    strcpy(message, query);
    strcat(message, "\n");
    fprintf(id, message);

    data_length = IEEEBLOCK_SPACE;
    iscanf(id, "%#b", &data_length, ieeeblock_data);

    if (data_length == IEEEBLOCK_SPACE )
    {
        printf("IEEE block buffer full: ");
        printf("May not have received all data.\n");
    }

    check_instrument_errors();

    return(data_length);
}

/* Check for instrument errors.
 * ----- */
void check_instrument_errors()
{
    char str_err_val[256] = {0};
    char str_out[800] = "";

    ipromptf(id, ":SYSTem:ERRor?\n", "%t", str_err_val);
    while(strncmp(str_err_val, "+0,No error", 3) != 0 )
    {
        strcat(str_out, ", ");
        strcat(str_out, str_err_val);
        ipromptf(id, ":SYSTem:ERRor?\n", "%t", str_err_val);
    }
}

```



```

    }

    if (strcmp(str_out, "") != 0)
    {
        printf("INST Error%s\n", str_out);
        iflush(id, I_BUF_READ | I_BUF_WRITE);
    }
}

```

SICL Example in Visual Basic

To run this example in Visual Basic for Applications:

- 1 Start the application that provides Visual Basic for Applications (for example, Microsoft Excel).
- 2 Press ALT+F11 to launch the Visual Basic editor.
- 3 Add the sicl32.bas file to your project:
 - a Choose **File > Import File...**
 - b Navigate to the header file, sicl32.bas (installed with Keysight IO Libraries Suite and found in the Program Files\Keysight\IO Libraries Suite\include directory), select it, and click **Open**.
- 4 Choose **Insert > Module**.
- 5 Cut-and-paste the code that follows into the editor.
- 6 Edit the program to use the SICL address of your oscilloscope, and save the changes.
- 7 Run the program.

```

'
' Keysight SICL Example in Visual Basic
' -----
' This program illustrates a few commonly-used programming
' features of your Keysight oscilloscope.
' -----

Option Explicit

Public id As Integer ' Session to instrument.

' Declare variables to hold numeric values returned by
' ivscanf/ifread.
Public dblQueryResult As Double
Public Const ByteArraySize = 5000000
Public retCount As Long
Public byteArray(ByteArraySize) As Byte

' Declare fixed length string variable to hold string value returned
' by ivscanf.
Public strQueryResult As String * 200

' For Sleep subroutine.

```

```

Private Declare Sub Sleep Lib "kernel32" (ByVal dwMilliseconds As Long)

'
' Main Program
' -----

Sub Main()

    On Error GoTo ErrorHandler

    ' Open a device session using the SICL_ADDRESS.
    id = iopen("usb0[2391::6054::US50210029::0]")
    Call itimeout(id, 5000)

    ' Initialize - start from a known state.
    Initialize

    ' Capture data.
    Capture

    ' Analyze the captured waveform.
    Analyze

    ' Close the vi session and the resource manager session.
    Call iclose(id)

    Exit Sub

ErrorHandler:

    MsgBox "*** Error : " + Error, vbExclamation
    End

End Sub

'
' Initialize the oscilloscope to a known state.
' -----

Private Sub Initialize()

    On Error GoTo ErrorHandler

    ' Clear the interface.
    Call iclear(id)

    ' Get and display the device's *IDN? string.
    strQueryResult = DoQueryString("*IDN?")
    MsgBox "Result is: " + RTrim(strQueryResult), vbOKOnly, "*IDN? Result"

    ' Clear status and load the default setup.
    DoCommand "*CLS"
    DoCommand "*RST"

    Exit Sub

ErrorHandler:

```

```

MsgBox "*** Error : " + Error, vbExclamation
End

End Sub

'
' Capture the waveform.
' -----

Private Sub Capture()

    On Error GoTo ErrorHandler

    ' Use auto-scale to automatically configure oscilloscope.
    ' -----
    DoCommand ":AUToscale"

    ' Set trigger mode (EDGE, PULSe, PATtern, etc., and input source.
    DoCommand ":TRIGger:MODE EDGE"
    Debug.Print "Trigger mode: " + _
        DoQueryString(":TRIGger:MODE?")

    ' Set EDGE trigger parameters.
    DoCommand ":TRIGger:EDGE:SOURce CHANnel1"
    Debug.Print "Trigger edge source: " + _
        DoQueryString(":TRIGger:EDGE:SOURce?")

    DoCommand ":TRIGger:EDGE:LEVel 1.5"
    Debug.Print "Trigger edge level: " + _
        DoQueryString(":TRIGger:EDGE:LEVel?")

    DoCommand ":TRIGger:EDGE:SLOPe POSitive"
    Debug.Print "Trigger edge slope: " + _
        DoQueryString(":TRIGger:EDGE:SLOPe?")

    ' Save oscilloscope configuration.
    ' -----

    Dim lngSetupStringSize As Long
    lngSetupStringSize = DoQueryIEEEBlock_Bytes(":SYSTem:SETup?")
    Debug.Print "Setup bytes saved: " + CStr(lngSetupStringSize)

    ' Output setup string to a file:
    Dim strPath As String
    strPath = "c:\scope\config\setup.dat"
    If Len(Dir(strPath)) Then
        Kill strPath ' Remove file if it exists.
    End If

    ' Open file for output.
    Dim hFile As Long
    hFile = FreeFile
    Open strPath For Binary Access Write Lock Write As hFile
    Dim lngI As Long
    For lngI = 0 To lngSetupStringSize - 1
        Put hFile, , byteArray(lngI) ' Write data.
    Next lngI

```

```

Close hFile    ' Close file.

' Change settings with individual commands:
' -----

' Set vertical scale and offset.
DoCommand ":CHANnel1:SCALE 0.05"
Debug.Print "Channel 1 vertical scale: " + _
    DoQueryString(":CHANnel1:SCALE?")

DoCommand ":CHANnel1:OFFSet -1.5"
Debug.Print "Channel 1 vertical offset: " + _
    DoQueryString(":CHANnel1:OFFSet?")

' Set horizontal scale and position.
DoCommand ":TIMEbase:SCALE 0.0002"
Debug.Print "Timebase scale: " + _
    DoQueryString(":TIMEbase:SCALE?")

DoCommand ":TIMEbase:POSition 0.0"
Debug.Print "Timebase position: " + _
    DoQueryString(":TIMEbase:POSition?")

' Set the acquisition type (NORMAL, PEAK, AVERAGE, or HRESOLUTION).
DoCommand ":ACquire:TYPE NORMAL"
Debug.Print "Acquire type: " + _
    DoQueryString(":ACquire:TYPE?")

' Or, configure by loading a previously saved setup.
' -----
strPath = "c:\scope\config\setup.dat"
Open strPath For Binary Access Read As hFile    ' Open file for input.
Dim lngSetupFileSize As Long
lngSetupFileSize = LOF(hFile)    ' Length of file.
Get hFile, , byteArray    ' Read data.
Close hFile    ' Close file.
' Write setup string back to oscilloscope using ":SYSTEM:SETup"
' command:
Dim lngRestored As Long
lngRestored = DoCommandIEEEBlock(":SYSTEM:SETup", lngSetupFileSize)
Debug.Print "Setup bytes restored: " + CStr(lngRestored)

' Capture an acquisition using :DIGitize.
' -----
DoCommand ":DIGitize CHANnel1"

Exit Sub

ErrorHandler:

MsgBox "*** Error : " + Error, vbExclamation
End

End Sub

'
' Analyze the captured waveform.

```

```

' -----
Private Sub Analyze()

    On Error GoTo ErrorHandler

    ' Make a couple of measurements.
    ' -----
    DoCommand ":MEASure:SOURce CHANnel1"
    Debug.Print "Measure source: " + _
        DoQueryString(":MEASure:SOURce?")

    DoCommand ":MEASure:FREQuency"
    dblQueryResult = DoQueryNumber(":MEASure:FREQuency?")
    MsgBox "Frequency:" + vbCrLf + _
        FormatNumber(dblQueryResult / 1000, 4) + " kHz"

    DoCommand ":MEASure:VAMPlitude"
    dblQueryResult = DoQueryNumber(":MEASure:VAMPlitude?")
    MsgBox "Vertical amplitude:" + vbCrLf + _
        FormatNumber(dblQueryResult, 4) + " V"

    ' Download the screen image.
    ' -----
    DoCommand ":HARDcopy:INKSaver OFF"

    ' Get screen image.
    Dim lngBlockSize As Long
    lngBlockSize = DoQueryIEEEBlock_Bytes(":DISPlay:DATA? PNG, COlor")
    Debug.Print "Screen image bytes: " + CStr(lngBlockSize)

    ' Save screen image to a file:
    Dim strPath As String
    strPath = "c:\scope\data\screen.png"
    If Len(Dir(strPath)) Then
        Kill strPath ' Remove file if it exists.
    End If
    Dim hFile As Long
    hFile = FreeFile
    Open strPath For Binary Access Write Lock Write As hFile
    Dim lngI As Long
    ' Skip past header.
    For lngI = CInt(Chr(byteArray(1))) + 2 To lngBlockSize - 1
        Put hFile, , byteArray(lngI) ' Write data.
    Next lngI
    Close hFile ' Close file.
    MsgBox "Screen image written to " + strPath

    ' Download waveform data.
    ' -----

    ' Set the waveform points mode.
    DoCommand ":WAVEform:POINts:MODE RAW"
    Debug.Print "Waveform points mode: " + _
        DoQueryString(":WAVEform:POINts:MODE?")

    ' Get the number of waveform points available.

```

```

DoCommand ":WAVeform:POINts 10240"
Debug.Print "Waveform points available: " + _
    DoQueryString(":WAVeform:POINts?")

' Set the waveform source.
DoCommand ":WAVeform:SOURce CHANnel1"
Debug.Print "Waveform source: " + _
    DoQueryString(":WAVeform:SOURce?")

' Choose the format of the data returned (WORD, BYTE, ASCII):
DoCommand ":WAVeform:FORMat BYTE"
Debug.Print "Waveform format: " + _
    DoQueryString(":WAVeform:FORMat?")

' Display the waveform settings:
Dim Preamble() As Double
Dim intFormat As Integer
Dim intType As Integer
Dim lngPoints As Long
Dim lngCount As Long
Dim dblXIncrement As Double
Dim dblXOrigin As Double
Dim lngXReference As Long
Dim sngYIncrement As Single
Dim sngYOrigin As Single
Dim lngYReference As Long

Preamble() = DoQueryNumbers(":WAVeform:PREAmble?")

intFormat = Preamble(0)
intType = Preamble(1)
lngPoints = Preamble(2)
lngCount = Preamble(3)
dblXIncrement = Preamble(4)
dblXOrigin = Preamble(5)
lngXReference = Preamble(6)
sngYIncrement = Preamble(7)
sngYOrigin = Preamble(8)
lngYReference = Preamble(9)

If intFormat = 0 Then
    Debug.Print "Waveform format: BYTE"
ElseIf intFormat = 1 Then
    Debug.Print "Waveform format: WORD"
ElseIf intFormat = 2 Then
    Debug.Print "Waveform format: ASCii"
End If

If intType = 0 Then
    Debug.Print "Acquisition type: NORMal"
ElseIf intType = 1 Then
    Debug.Print "Acquisition type: PEAK"
ElseIf intType = 2 Then
    Debug.Print "Acquisition type: AVERage"
ElseIf intType = 3 Then
    Debug.Print "Acquisition type: HRESolution"
End If

```

```

Debug.Print "Waveform points: " + _
    FormatNumber(lngPoints, 0)

Debug.Print "Waveform average count: " + _
    FormatNumber(lngCount, 0)

Debug.Print "Waveform X increment: " + _
    Format(dblXIncrement, "Scientific")

Debug.Print "Waveform X origin: " + _
    Format(dblXOrigin, "Scientific")

Debug.Print "Waveform X reference: " + _
    FormatNumber(lngXReference, 0)

Debug.Print "Waveform Y increment: " + _
    Format(sngYIncrement, "Scientific")

Debug.Print "Waveform Y origin: " + _
    FormatNumber(sngYOrigin, 0)

Debug.Print "Waveform Y reference: " + _
    FormatNumber(lngYReference, 0)

' Get the waveform data
Dim lngNumBytes As Long
lngNumBytes = DoQueryIEEEBlock_Bytes(":WAVEform:DATA?")
Debug.Print "Number of data values: " + _
    CStr(lngNumBytes - CInt(Chr(byteArray(1))) - 2)

' Set up output file:
strPath = "c:\scope\data\waveform_data.csv"

' Open file for output.
Open strPath For Output Access Write Lock Write As hFile

' Output waveform data in CSV format.
Dim lngDataValue As Long

' Skip past header.
For lngI = CInt(Chr(byteArray(1))) + 2 To lngNumBytes - 2
    lngDataValue = CLng(byteArray(lngI))

    ' Write time value, voltage value.
    Print #hFile, _
        FormatNumber(dblXOrigin + (lngI * dblXIncrement), 9) + _
        ", " + _
        FormatNumber(((lngDataValue - lngYReference) * _
            sngYIncrement) + sngYOrigin)

Next lngI

' Close output file.
Close hFile ' Close file.
MsgBox "Waveform format BYTE data written to " + _
    "c:\scope\data\waveform_data.csv."

```

```

        Exit Sub

ErrorHandler:

    MsgBox "*** Error : " + Error, vbExclamation
    End

End Sub

Private Sub DoCommand(command As String)

    On Error GoTo ErrorHandler

    Call ivprintf(id, command + vbLf)

    CheckInstrumentErrors

    Exit Sub

ErrorHandler:

    MsgBox "*** Error : " + Error, vbExclamation
    End

End Sub

Private Function DoCommandIEEEBlock(command As String, _
    lngBlockSize As Long)

    On Error GoTo ErrorHandler

    ' Send command part.
    Call ivprintf(id, command + " ")

    ' Write definite-length block bytes.
    Call ifwrite(id, byteArray(), lngBlockSize, vbNull, retCount)

    ' retCount is now actual number of bytes written.
    DoCommandIEEEBlock = retCount

    CheckInstrumentErrors

    Exit Function

ErrorHandler:

    MsgBox "*** Error : " + Error, vbExclamation
    End

End Function

Private Function DoQueryString(query As String) As String

    Dim actual As Long

    On Error GoTo ErrorHandler

```



```

Dim strResult As String * 200

Call ivprintf(id, query + vbLf)
Call ivscanf(id, "%200t", strResult)
DoQueryString = strResult

CheckInstrumentErrors

Exit Function

ErrorHandler:

MsgBox "*** Error : " + Error, vbExclamation
End

End Function

Private Function DoQueryNumber(query As String) As Double

On Error GoTo ErrorHandler

Dim dblResult As Double

Call ivprintf(id, query + vbLf)
Call ivscanf(id, "%lf" + vbLf, dblResult)
DoQueryNumber = dblResult

CheckInstrumentErrors

Exit Function

ErrorHandler:

MsgBox "*** Error : " + Error, vbExclamation
End

End Function

Private Function DoQueryNumbers(query As String) As Double()

On Error GoTo ErrorHandler

Dim dblResults(10) As Double

Call ivprintf(id, query + vbLf)
Call ivscanf(id, "%,10lf" + vbLf, dblResults)
DoQueryNumbers = dblResults

CheckInstrumentErrors

Exit Function

ErrorHandler:

MsgBox "*** Error : " + Error, vbExclamation
End

```

```

End Function

Private Function DoQueryIEEEBlock_Bytes(query As String) As Long

    On Error GoTo ErrorHandler

    ' Send query.
    Call ivprintf(id, query + vbCrLf)

    ' Read definite-length block bytes.
    Sleep 2000 ' Delay before reading data.
    Call ifread(id, byteArray(), ByteArraySize, vbNull, retCount)

    ' Get number of block length digits.
    Dim intLengthDigits As Integer
    intLengthDigits = CInt(Chr(byteArray(1)))

    ' Get block length from those digits.
    Dim strBlockLength As String
    strBlockLength = ""
    Dim i As Integer
    For i = 2 To intLengthDigits + 1
        strBlockLength = strBlockLength + Chr(byteArray(i))
    Next

    ' Return number of bytes in block plus header.
    DoQueryIEEEBlock_Bytes = CLng(strBlockLength) + intLengthDigits + 2

    CheckInstrumentErrors

    Exit Function

ErrorHandler:

    MsgBox "*** Error : " + Error, vbExclamation
    End

End Function

Private Sub CheckInstrumentErrors()

    On Error GoTo ErrorHandler

    Dim strErrVal As String * 200
    Dim strOut As String

    Call ivprintf(id, ":SYSTEM:ERROR?" + vbCrLf) ' Query any errors data.
    Call ivscanf(id, "%200t", strErrVal) ' Read: Errnum,"Error String".
    While Val(strErrVal) <> 0 ' End if find: +0,"No Error".
        strOut = strOut + "INST Error: " + strErrVal
        Call ivprintf(id, ":SYSTEM:ERROR?" + vbCrLf) ' Request error message
    .
        Call ivscanf(id, "%200t", strErrVal) ' Read error message.
    Wend

    If Not strOut = "" Then

```

```
    MsgBox strOut, vbExclamation, "INST Error Messages"  
    Call iflush(id, I_BUF_READ Or I_BUF_WRITE)  
  
End If  
  
Exit Sub  
  
ErrorHandler:  
  
    MsgBox "*** Error : " + Error, vbExclamation  
    End  
  
End Sub
```

SCPI.NET Examples

These programming examples show how to use the SCPI.NET drivers that come with Keysight's free Command Expert software.

While you can write code manually using SCPI.NET drivers (as described in this section), you can also use the Command Expert software to:

- Connect to instruments and control them interactively using SCPI command sets.
- Quickly prototype and test command sequences.
- Generate C#, VB.NET, or C/C++ code for command sequences.
- Find, download, and install SCPI command sets.
- Browse command trees, search for commands, and view command descriptions.

The Command Expert suite also comes with Add-ons for easy instrument control and measurement data retrieval in NI LabVIEW, Microsoft Excel, Keysight VEE, and Keysight SystemVue.

For more information on Keysight Command Expert, and to download the software, see: <http://www.keysight.com/find/commandexpert>

- "[SCPI.NET Example in C#](#)" on page 1500
- "[SCPI.NET Example in Visual Basic .NET](#)" on page 1506
- "[SCPI.NET Example in IronPython](#)" on page 1512

SCPI.NET Example in C#

To compile and run this example in Microsoft Visual Studio 2008:

- 1 Install the Keysight Command Expert software and the command set for the oscilloscope.
- 2 Open Visual Studio.
- 3 Create a new Visual C#, Windows, Console Application project.
- 4 Cut-and-paste the code that follows into the C# source file.
- 5 Edit the program to use the address of your oscilloscope.
- 6 Add a reference to the SCPI.NET driver:
 - a Right-click the project you wish to modify (not the solution) in the Solution Explorer window of the Microsoft Visual Studio environment.
 - b Choose **Add Reference...**
 - c In the Add Reference dialog, select the **Browse** tab, and navigate to the ScpiNetDrivers folder.

- Windows XP: C:\Documents and Settings\All Users\Keysight\Command Expert\ScpiNetDrivers
 - Windows 7: C:\ProgramData\Keysight\Command Expert\ScpiNetDrivers
- d** Select the .dll file for your oscilloscope, for example **AgInfiniiVision3000X_02_00.dll**; then, click **OK**.

7 Build and run the program.

For more information, see the SCPI.NET driver help that comes with Keysight Command Expert.

```

/*
 * Keysight SCPI.NET Example in C#
 * -----
 * This program illustrates a few commonly used programming
 * features of your Keysight oscilloscope.
 * -----
 */

using System;
using System.IO;
using System.Text;
using Keysight.CommandExpert.ScpiNet.AgInfiniiVision3000X_02_00;

namespace InfiniiVision
{
    class ScpiNetInstrumentApp
    {
        private static AgInfiniiVision3000X myScope;

        static void Main(string[] args)
        {
            try
            {
                string strScopeAddress;
                //strScopeAddress = "a-mx3054a-60028.cos.keysight.com";
                strScopeAddress =
                    "TCPIP0::a-mx4054a-60154.cos.keysight.com::inst0::INSTR";
                Console.WriteLine("Connecting to oscilloscope...");
                Console.WriteLine();
                myScope = new AgInfiniiVision3000X(strScopeAddress);
                myScope.Transport.DefaultTimeout.Set(10000);

                // Initialize - start from a known state.
                Initialize();

                // Capture data.
                Capture();

                // Analyze the captured waveform.
                Analyze();

                Console.WriteLine("Press any key to exit");
                Console.ReadKey();
            }
        }
    }
}

```

```

        catch (System.ApplicationException err)
        {
            Console.WriteLine("*** SCPI.NET Error : " + err.Message);
        }
        catch (System.SystemException err)
        {
            Console.WriteLine("*** System Error Message : " + err.Message);
        }
        catch (System.Exception err)
        {
            System.Diagnostics.Debug.Fail("Unexpected Error");
            Console.WriteLine("*** Unexpected Error : " + err.Message);
        }
        finally
        {
            //myScope.Dispose();
        }
    }

    /*
    * Initialize the oscilloscope to a known state.
    * -----
    */
    private static void Initialize()
    {
        string strResults;

        // Get and display the device's *IDN? string.
        myScope.SCPi.IDN.Query(out strResults);
        Console.WriteLine("*IDN? result is: {0}", strResults);

        // Clear status and load the default setup.
        myScope.SCPi.CLS.Command();
        myScope.SCPi.RST.Command();
    }

    /*
    * Capture the waveform.
    * -----
    */
    private static void Capture()
    {
        string strResults;
        double fResult;

        // Use auto-scale to automatically configure oscilloscope.
        myScope.SCPi.AUToscale.Command(null, null, null, null, null);

        // Set trigger mode.
        myScope.SCPi.TRIGger.MODE.Command("EDGE");
        myScope.SCPi.TRIGger.MODE.Query(out strResults);
        Console.WriteLine("Trigger mode: {0}", strResults);

        // Set EDGE trigger parameters.
        myScope.SCPi.TRIGger.EDGE.SOURce.Command("CHANnel1");
        myScope.SCPi.TRIGger.EDGE.SOURce.Query(out strResults);
    }

```

```

Console.WriteLine("Trigger edge source: {0}", strResults);

myScope.SCPi.TRIGger.EDGE.LEVel.Command(1.5, "CHANnel1");
myScope.SCPi.TRIGger.EDGE.LEVel.Query("CHANnel1", out fResult);
Console.WriteLine("Trigger edge level: {0:F2}", fResult);

myScope.SCPi.TRIGger.EDGE.SLOPe.Command("POSitive");
myScope.SCPi.TRIGger.EDGE.SLOPe.Query(out strResults);
Console.WriteLine("Trigger edge slope: {0}", strResults);

// Save oscilloscope configuration.
string[] strResultsArray; // Results array.
int nLength; // Number of bytes returned from instrument.
string strPath;

// Query and read setup string.
myScope.SCPi.SYSTem.SETup.Query(out strResultsArray);
nLength = strResultsArray.Length;

// Write setup string to file.
strPath = "c:\\scope\\config\\setup.stp";
File.WriteAllLines(strPath, strResultsArray);
Console.WriteLine("Setup bytes saved: {0}", nLength);

// Change settings with individual commands:

// Set vertical scale and offset.
myScope.SCPi.CHANnel.SCALe.Command(1, 0.05);
myScope.SCPi.CHANnel.SCALe.Query(1, out fResult);
Console.WriteLine("Channel 1 vertical scale: {0:F4}", fResult);

myScope.SCPi.CHANnel.OFFSet.Command(1, -1.5);
myScope.SCPi.CHANnel.OFFSet.Query(1, out fResult);
Console.WriteLine("Channel 1 vertical offset: {0:F4}", fResult);

// Set horizontal scale and offset.
myScope.SCPi.TIMEbase.SCALe.Command(0.0002);
myScope.SCPi.TIMEbase.SCALe.Query(out fResult);
Console.WriteLine("Timebase scale: {0:F4}", fResult);

myScope.SCPi.TIMEbase.POSition.Command(0.0);
myScope.SCPi.TIMEbase.POSition.Query(out fResult);
Console.WriteLine("Timebase position: {0:F2}", fResult);

// Set the acquisition type.
myScope.SCPi.ACQuire.TYPE.Command("NORMal");
myScope.SCPi.ACQuire.TYPE.Query(out strResults);
Console.WriteLine("Acquire type: {0}", strResults);

// Or, configure by loading a previously saved setup.
int nBytesWritten;

strPath = "c:\\scope\\config\\setup.stp";
strResultsArray = File.ReadAllLines(strPath);
nBytesWritten = strResultsArray.Length;

```

```

// Restore setup string.
myScope.SCPi.SYSteM.SETup.Command(strResultsArray);
Console.WriteLine("Setup bytes restored: {0}", nBytesWritten);

// Capture an acquisition using :DIGitize.
myScope.SCPi.DIGitize.Command("CHANnel1", null, null, null, null);
}

/*
 * Analyze the captured waveform.
 * -----
 */
private static void Analyze()
{
    string strResults, source1, source2;
    double fResult;

    // Make a couple of measurements.
    // -----
    myScope.SCPi.MEASure.SOURce.Command("CHANnel1", null);
    myScope.SCPi.MEASure.SOURce.Query(out source1, out source2);
    Console.WriteLine("Measure source: {0}", source1);

    myScope.SCPi.MEASure.FREQuency.Command("CHANnel1");
    myScope.SCPi.MEASure.FREQuency.Query("CHANnel1", out fResult);
    Console.WriteLine("Frequency: {0:F4} kHz", fResult / 1000);

    // Use direct command/query when commands not in command set.
    myScope.Transport.Command.Invoke(":MEASure:VAMPlitude CHANnel1");
    myScope.Transport.Query.Invoke(":MEASure:VAMPlitude? CHANnel1",
        out strResults);
    Console.WriteLine("Vertical amplitude: {0} V", strResults);

    // Download the screen image.
    // -----
    myScope.SCPi.HARDcopy.INKSaver.Command(false);

    // Get the screen data.
    byte[] byteResultsArray; // Results array.
    myScope.SCPi.DISPlay.DATA.Query("PNG", "COLor",
        out byteResultsArray);
    int nLength; // Number of bytes returned from instrument.
    nLength = byteResultsArray.Length;

    // Store the screen data to a file.
    string strPath;
    strPath = "c:\\scope\\data\\screen.png";
    FileStream fStream = File.Open(strPath, FileMode.Create);
    fStream.Write(byteResultsArray, 0, nLength);
    fStream.Close();
    Console.WriteLine("Screen image ({0} bytes) written to {1}",
        nLength, strPath);

    // Download waveform data.
    // -----

    // Set the waveform points mode.

```



```

myScope.SCPi.WAVEform.POINTs.MODE.Command("RAW");
myScope.SCPi.WAVEform.POINTs.MODE.Query(out strResults);
Console.WriteLine("Waveform points mode: {0}", strResults);

// Get the number of waveform points available.
myScope.SCPi.WAVEform.POINTs.CommandPoints(10240);
int nPointsAvail;
myScope.SCPi.WAVEform.POINTs.Query1(out nPointsAvail);
Console.WriteLine("Waveform points available: {0}", nPointsAvail);

// Set the waveform source.
myScope.SCPi.WAVEform.SOURce.Command("CHANnel1");
myScope.SCPi.WAVEform.SOURce.Query(out strResults);
Console.WriteLine("Waveform source: {0}", strResults);

// Choose the format of the data returned (WORD, BYTE, ASCII):
myScope.SCPi.WAVEform.FORMat.Command("BYTE");
myScope.SCPi.WAVEform.FORMat.Query(out strResults);
Console.WriteLine("Waveform format: {0}", strResults);

// Display the waveform settings:
int nFormat, nType, nPoints, nCount, nXreference, nYreference;
double dblXincrement, dblXorigin, dblYincrement, dblYorigin;
myScope.SCPi.WAVEform.PREAmble.Query(
    out nFormat,
    out nType,
    out nPoints,
    out nCount,
    out dblXincrement,
    out dblXorigin,
    out nXreference,
    out dblYincrement,
    out dblYorigin,
    out nYreference);

if (nFormat == 0)
{
    Console.WriteLine("Waveform format: BYTE");
}
else if (nFormat == 1)
{
    Console.WriteLine("Waveform format: WORD");
}
else if (nFormat == 2)
{
    Console.WriteLine("Waveform format: ASCii");
}

if (nType == 0)
{
    Console.WriteLine("Acquire type: NORMal");
}
else if (nType == 1)
{
    Console.WriteLine("Acquire type: PEAK");
}
else if (nType == 2)

```

```

    {
        Console.WriteLine("Acquire type: AVERage");
    }
else if (nType == 3)
    {
        Console.WriteLine("Acquire type: HRESolution");
    }

Console.WriteLine("Waveform points: {0:e}", nPoints);
Console.WriteLine("Waveform average count: {0:e}", nCount);
Console.WriteLine("Waveform X increment: {0:e}", dblXincrement);
Console.WriteLine("Waveform X origin: {0:e}", dblXorigin);
Console.WriteLine("Waveform X reference: {0:e}", nXreference);
Console.WriteLine("Waveform Y increment: {0:e}", dblYincrement);
Console.WriteLine("Waveform Y origin: {0:e}", dblYorigin);
Console.WriteLine("Waveform Y reference: {0:e}", nYreference);

// Read waveform data.
myScope.SCPi.WAVEform.DATA.QueryBYTE(out byteResultsArray);
nLength = byteResultsArray.Length;
Console.WriteLine("Number of data values: {0}", nLength);

// Set up output file:
strPath = "c:\\scope\\data\\waveform_data.csv";
if (File.Exists(strPath)) File.Delete(strPath);

// Open file for output.
StreamWriter writer = File.CreateText(strPath);

// Output waveform data in CSV format.
for (int i = 0; i < nLength - 1; i++)
    writer.WriteLine("{0:f9}, {1:f6}",
        dblXorigin + ((float)i * dblXincrement),
        (((float)byteResultsArray[i] - nYreference)
        * dblYincrement) + dblYorigin);

// Close output file.
writer.Close();
Console.WriteLine("Waveform format BYTE data written to {0}",
    strPath);
}
}
}

```

SCPI.NET Example in Visual Basic .NET

To compile and run this example in Microsoft Visual Studio 2008:

- 1 Install the Keysight Command Expert software and the command set for the oscilloscope.
- 2 Open Visual Studio.
- 3 Create a new Visual Basic, Windows, Console Application project.
- 4 Cut-and-paste the code that follows into the Visual Basic .NET source file.

- 5 Edit the program to use the VISA address of your oscilloscope.
- 6 Add a reference to the SCPI.NET 3.0 driver:
 - a Right-click the project you wish to modify (not the solution) in the Solution Explorer window of the Microsoft Visual Studio environment.
 - b Choose **Add Reference...**
 - c In the Add Reference dialog, select the **Browse** tab, and navigate to the ScpiNetDrivers folder.
 - Windows XP: C:\Documents and Settings\All Users\Keysight\Command Expert\ScpiNetDrivers
 - Windows 7: C:\ProgramData\Keysight\Command Expert\ScpiNetDrivers
 - d Select the .dll file for your oscilloscope, for example **AgInfiniiVision3000X_02_00.dll**; then, click **OK**.
 - e Right-click the project you wish to modify (not the solution) in the Solution Explorer window of the Microsoft Visual Studio environment and choose **Properties**; then, select "InfiniiVision.ScpiNetInstrumentApp" as the **Startup object**.
- 7 Build and run the program.

For more information, see the SCPI.NET driver help that comes with Keysight Command Expert.

```
'
' Keysight SCPI.NET Example in Visual Basic .NET
' -----
' This program illustrates a few commonly used programming
' features of your Keysight oscilloscope.
' -----

Imports System
Imports System.IO
Imports System.Text
Imports Keysight.CommandExpert.ScpiNet.AgInfiniiVision3000X_02_00

Namespace InfiniiVision
  Class ScpiNetInstrumentApp
    Private Shared myScope As AgInfiniiVision3000X

    Public Shared Sub Main(ByVal args As String())
      Try
        Dim strScopeAddress As String
        'strScopeAddress = "a-mx3054a-60028.cos.keysight.com";
        strScopeAddress = _
          "TCPIP0::a-mx4054a-60154.cos.keysight.com::inst0::INSTR"
        Console.WriteLine("Connecting to oscilloscope...")
        Console.WriteLine()
        myScope = New AgInfiniiVision3000X(strScopeAddress)
        myScope.Transport.DefaultTimeout.[Set](10000)

        ' Initialize - start from a known state.
        Initialize()
      End Try
    End Sub
  End Class
End Namespace
```

```

        ' Capture data.
        Capture()

        ' Analyze the captured waveform.
        Analyze()

        Console.WriteLine("Press any key to exit")
        Console.ReadKey()
    Catch err As System.ApplicationException
        Console.WriteLine("*** SCPI.NET Error : " & err.Message)
    Catch err As System.SystemException
        Console.WriteLine("*** System Error Message : " & err.Message)
    Catch err As System.Exception
        System.Diagnostics.Debug.Fail("Unexpected Error")
        Console.WriteLine("*** Unexpected Error : " & err.Message)
    'myScope.Dispose();
    Finally
    End Try

End Sub

' Initialize the oscilloscope to a known state.
' -----

Private Shared Sub Initialize()
    Dim strResults As String

    ' Get and display the device's *IDN? string.
    myScope.SCPI.IDN.Query(strResults)
    Console.WriteLine("*IDN? result is: {0}", strResults)

    ' Clear status and load the default setup.
    myScope.SCPI.CLS.Command()
    myScope.SCPI.RST.Command()
End Sub

' Capture the waveform.
' -----

Private Shared Sub Capture()
    Dim strResults As String
    Dim fResult As Double

    ' Use auto-scale to automatically configure oscilloscope.
    myScope.SCPI.AUToscale.Command(Nothing, Nothing, Nothing, _
        Nothing, Nothing)

    ' Set trigger mode.
    myScope.SCPI.TRIGger.MODE.Command("EDGE")
    myScope.SCPI.TRIGger.MODE.Query(strResults)
    Console.WriteLine("Trigger mode: {0}", strResults)

    ' Set EDGE trigger parameters.
    myScope.SCPI.TRIGger.EDGE.SOURce.Command("CHANnel1")
    myScope.SCPI.TRIGger.EDGE.SOURce.Query(strResults)
    Console.WriteLine("Trigger edge source: {0}", strResults)

```

```

myScope.SCPi.TRIGger.EDGE.LEVel.Command(1.5, "CHANnel1")
myScope.SCPi.TRIGger.EDGE.LEVel.Query("CHANnel1", fResult)
Console.WriteLine("Trigger edge level: {0:F2}", fResult)

myScope.SCPi.TRIGger.EDGE.SLOPe.Command("POSitive")
myScope.SCPi.TRIGger.EDGE.SLOPe.Query(strResults)
Console.WriteLine("Trigger edge slope: {0}", strResults)

' Save oscilloscope configuration.
Dim strResultsArray As String()
' Results array.
Dim nLength As Integer
' Number of bytes returned from instrument.
Dim strPath As String

' Query and read setup string.
myScope.SCPi.SYSTem.SETup.Query(strResultsArray)
nLength = strResultsArray.Length

' Write setup string to file.
strPath = "c:\scope\config\setup.stp"
File.WriteAllLines(strPath, strResultsArray)
Console.WriteLine("Setup bytes saved: {0}", nLength)

' Change settings with individual commands:

' Set vertical scale and offset.
myScope.SCPi.CHANnel.SCALe.Command(1, 0.05)
myScope.SCPi.CHANnel.SCALe.Query(1, fResult)
Console.WriteLine("Channel 1 vertical scale: {0:F4}", fResult)

myScope.SCPi.CHANnel.OFFSet.Command(1, -1.5)
myScope.SCPi.CHANnel.OFFSet.Query(1, fResult)
Console.WriteLine("Channel 1 vertical offset: {0:F4}", fResult)

' Set horizontal scale and offset.
myScope.SCPi.TIMEbase.SCALe.Command(0.0002)
myScope.SCPi.TIMEbase.SCALe.Query(fResult)
Console.WriteLine("Timebase scale: {0:F4}", fResult)

myScope.SCPi.TIMEbase.POSition.Command(0.0)
myScope.SCPi.TIMEbase.POSition.Query(fResult)
Console.WriteLine("Timebase position: {0:F2}", fResult)

' Set the acquisition type.
myScope.SCPi.ACQuire.TYPE.Command("NORMal")
myScope.SCPi.ACQuire.TYPE.Query(strResults)
Console.WriteLine("Acquire type: {0}", strResults)

' Or, configure by loading a previously saved setup.
Dim nBytesWritten As Integer

strPath = "c:\scope\config\setup.stp"
strResultsArray = File.ReadAllLines(strPath)
nBytesWritten = strResultsArray.Length

```

```

' Restore setup string.
myScope.SCPi.SYSteM.SETup.Command(strResultsArray)
Console.WriteLine("Setup bytes restored: {0}", nBytesWritten)

' Capture an acquisition using :DIGitize.
myScope.SCPi.DIGitize.Command("CHANnel1", Nothing, Nothing, _
    Nothing, Nothing)
End Sub

' Analyze the captured waveform.
' -----

Private Shared Sub Analyze()
    Dim strResults As String, source1 As String, source2 As String
    Dim fResult As Double

    ' Make a couple of measurements.
    ' -----
    myScope.SCPi.MEASure.SOURce.Command("CHANnel1", Nothing)
    myScope.SCPi.MEASure.SOURce.Query(source1, source2)
    Console.WriteLine("Measure source: {0}", source1)

    myScope.SCPi.MEASure.FREQuency.Command("CHANnel1")
    myScope.SCPi.MEASure.FREQuency.Query("CHANnel1", fResult)
    Console.WriteLine("Frequency: {0:F4} kHz", fResult / 1000)

    ' Use direct command/query when commands not in command set.
    myScope.Transport.Command.Invoke(":MEASure:VAMPlitude CHANnel1")
    myScope.Transport.Query.Invoke(":MEASure:VAMPlitude? CHANnel1", _
        strResults)
    Console.WriteLine("Vertical amplitude: {0} V", strResults)

    ' Download the screen image.
    ' -----
    myScope.SCPi.HARDcopy.INKSaver.Command(False)

    ' Get the screen data.
    Dim byteResultsArray As Byte()
    ' Results array.
    myScope.SCPi.DISPlay.DATA.Query("PNG", "COLor", byteResultsArray)
    Dim nLength As Integer
    ' Number of bytes returned from instrument.
    nLength = byteResultsArray.Length

    ' Store the screen data to a file.
    Dim strPath As String
    strPath = "c:\scope\data\screen.png"
    Dim fStream As FileStream = File.Open(strPath, FileMode.Create)
    fStream.Write(byteResultsArray, 0, nLength)
    fStream.Close()
    Console.WriteLine("Screen image ({0} bytes) written to {1}", _
        nLength, strPath)

    ' Download waveform data.
    ' -----

```

```

' Set the waveform points mode.
myScope.SCPi.WAVEform.POINTs.MODE.Command("RAW")
myScope.SCPi.WAVEform.POINTs.MODE.Query(strResults)
Console.WriteLine("Waveform points mode: {0}", strResults)

' Get the number of waveform points available.
myScope.SCPi.WAVEform.POINTs.CommandPoints(10240)
Dim nPointsAvail As Integer
myScope.SCPi.WAVEform.POINTs.Query1(nPointsAvail)
Console.WriteLine("Waveform points available: {0}", nPointsAvail)

' Set the waveform source.
myScope.SCPi.WAVEform.SOURce.Command("CHANnel1")
myScope.SCPi.WAVEform.SOURce.Query(strResults)
Console.WriteLine("Waveform source: {0}", strResults)

' Choose the format of the data returned (WORD, BYTE, ASCII):
myScope.SCPi.WAVEform.FORMat.Command("BYTE")
myScope.SCPi.WAVEform.FORMat.Query(strResults)
Console.WriteLine("Waveform format: {0}", strResults)

' Display the waveform settings:
Dim nFormat As Integer, nType As Integer, nPoints As Integer, _
    nCount As Integer, nXreference As Integer, _
    nYreference As Integer
Dim dblXincrement As Double, dblXorigin As Double, _
    dblYincrement As Double, dblYorigin As Double
myScope.SCPi.WAVEform.PREAmble.Query(nFormat, nType, nPoints, _
    nCount, dblXincrement, dblXorigin, nXreference, _
    dblYincrement, dblYorigin, nYreference)

If nFormat = 0 Then
    Console.WriteLine("Waveform format: BYTE")
ElseIf nFormat = 1 Then
    Console.WriteLine("Waveform format: WORD")
ElseIf nFormat = 2 Then
    Console.WriteLine("Waveform format: ASCii")
End If

If nType = 0 Then
    Console.WriteLine("Acquire type: NORMal")
ElseIf nType = 1 Then
    Console.WriteLine("Acquire type: PEAK")
ElseIf nType = 2 Then
    Console.WriteLine("Acquire type: AVERage")
ElseIf nType = 3 Then
    Console.WriteLine("Acquire type: HRESolution")
End If

Console.WriteLine("Waveform points: {0:e}", nPoints)
Console.WriteLine("Waveform average count: {0:e}", nCount)
Console.WriteLine("Waveform X increment: {0:e}", dblXincrement)
Console.WriteLine("Waveform X origin: {0:e}", dblXorigin)
Console.WriteLine("Waveform X reference: {0:e}", nXreference)
Console.WriteLine("Waveform Y increment: {0:e}", dblYincrement)
Console.WriteLine("Waveform Y origin: {0:e}", dblYorigin)
Console.WriteLine("Waveform Y reference: {0:e}", nYreference)

```

```

' Read waveform data.
myScope.SCPi.WAVEform.DATA.QueryBYTE(byteResultsArray)
nLength = byteResultsArray.Length
Console.WriteLine("Number of data values: {0}", nLength)

' Set up output file:
strPath = "c:\scope\data\waveform_data.csv"
If File.Exists(strPath) Then
    File.Delete(strPath)
End If

' Open file for output.
Dim writer As StreamWriter = File.CreateText(strPath)

' Output waveform data in CSV format.
For i As Integer = 0 To nLength - 2
    writer.WriteLine("{0:f9}, {1:f6}", _
        dblXorigin + (CSng(i) * dblXincrement), _
        ((CSng(byteResultsArray(i)) - nYreference) * _
        dblYincrement) + dblYorigin)
Next

' Close output file.
writer.Close()
Console.WriteLine("Waveform format BYTE data written to {0}", _
    strPath)

End Sub
End Class
End Namespace

```

SCPI.NET Example in IronPython

You can also control Keysight oscilloscopes using the SCPI.NET library and Python programming language on the .NET platform using:

- IronPython (<http://ironpython.codeplex.com/>) which is an implementation of the Python programming language running under .NET.

To run this example with IronPython:

- 1 Install the Keysight Command Expert software and the command set for the oscilloscope.
- 2 Cut-and-paste the code that follows into a file named "example.py".
- 3 Edit the program to use the address of your oscilloscope.
- 4 If the IronPython "ipy.exe" can be found via your PATH environment variable, open a Command Prompt window; then, change to the folder that contains the "example.py" file, and enter:

```

ipy example.py

#
# Keysight SCPI.NET Example in IronPython
# *****

```



```

# This program illustrates a few commonly used programming
# features of your Keysight oscilloscope.
# *****

# Import Python modules.
# -----
import sys
sys.path.append("C:\Python26\Lib") # Python Standard Library.
sys.path.append("C:\ProgramData\Keysight\Command Expert\ScpiNetDrivers")
import string

# Import .NET modules.
# -----
from System import *
from System.IO import *
from System.Text import *
from System.Runtime.InteropServices import *
import clr
clr.AddReference("AgInfiniiVision4000X_01_20")
from Keysight.CommandExpert.ScpiNet.AgInfiniiVision4000X_01_20 import *

# =====
# Initialize:
# =====
def initialize():

    # Get and display the device's *IDN? string.
    idn_string = scope.SCPi.IDN.Query()
    print "Identification string '%s'" % idn_string

    # Clear status and load the default setup.
    scope.SCPi.CLS.Command()
    scope.SCPi.RST.Command()

# =====
# Capture:
# =====
def capture():

    # Use auto-scale to automatically set up oscilloscope.
    print "Autoscale."
    scope.SCPi.AUToscale.Command(None, None, None, None, None)

    # Set trigger mode.
    scope.SCPi.TRIGger.MODE.Command("EDGE")
    qresult = scope.SCPi.TRIGger.MODE.Query()
    print "Trigger mode: %s" % qresult

    # Set EDGE trigger parameters.
    scope.SCPi.TRIGger.EDGE.SOURce.Command("CHANnel1")
    qresult = scope.SCPi.TRIGger.EDGE.SOURce.Query()
    print "Trigger edge source: %s" % qresult

    scope.SCPi.TRIGger.EDGE.LEVel.Command(1.5, "CHANnel1")
    qresult = scope.SCPi.TRIGger.EDGE.LEVel.Query("CHANnel1")

```

```

print "Trigger edge level: %s" % qresult

scope.SCPI.TRIGger.EDGE.SLOPe.Command("POSitive")
qresult = scope.SCPI.TRIGger.EDGE.SLOPe.Query()
print "Trigger edge slope: %s" % qresult

# Save oscilloscope setup.
setup_lines = scope.SCPI.SYSTem.SETUp.Query()
nLength = len(setup_lines)
File.WriteAllLines("setup.stp", setup_lines)
print "Setup lines saved: %d" % nLength

# Change oscilloscope settings with individual commands:

# Set vertical scale and offset.
scope.SCPI.CHANnel.SCALe.Command(1, 0.05)
qresult = scope.SCPI.CHANnel.SCALe.Query(1)
print "Channel 1 vertical scale: %f" % qresult

scope.SCPI.CHANnel.OFFSet.Command(1, -1.5)
qresult = scope.SCPI.CHANnel.OFFSet.Query(1)
print "Channel 1 offset: %f" % qresult

# Set horizontal scale and offset.
scope.SCPI.TIMEbase.SCALe.Command(0.0002)
qresult = scope.SCPI.TIMEbase.SCALe.Query()
print "Timebase scale: %f" % qresult

scope.SCPI.TIMEbase.POSition.Command(0.0)
qresult = scope.SCPI.TIMEbase.POSition.Query()
print "Timebase position: %f" % qresult

# Set the acquisition type.
scope.SCPI.ACQuire.TYPE.Command("NORMal")
qresult = scope.SCPI.ACQuire.TYPE.Query()
print "Acquire type: %s" % qresult

# Or, set up oscilloscope by loading a previously saved setup.
setup_lines = File.ReadAllLines("setup.stp")
scope.SCPI.SYSTem.SETUp.Command(setup_lines)
print "Setup lines restored: %d" % len(setup_lines)

# Capture an acquisition using :DIGitize.
scope.SCPI.DIGitize.Command("CHANnel1", None, None, None, None)

# =====
# Analyze:
# =====
def analyze():

# Make measurements.
# -----
scope.SCPI.MEASure.SOURce.Command("CHANnel1", None)
(source1, source2) = scope.SCPI.MEASure.SOURce.Query()
print "Measure source: %s" % source1

```

```

scope.SCPi.MEASure.FREQuency.Command("CHANnel1")
qresult = scope.SCPi.MEASure.FREQuency.Query("CHANnel1")
print "Measured frequency on channel 1: %f" % qresult

# Use direct command/query when commands not in command set.
scope.Transport.Command.Invoke(":MEASure:VAMPlitude CHANnel1")
qresult = scope.Transport.Query.Invoke(":MEASure:VAMPlitude? CHANnel1")
print "Measured vertical amplitude on channel 1: %s" % qresult

# Download the screen image.
# -----
scope.SCPi.HARDcopy.INKSaver.Command(False)

image_bytes = scope.SCPi.DISPlay.DATA.Query("PNG", "COLor")
nLength = len(image_bytes)
fStream = File.Open("screen_image.png", FileMode.Create)
fStream.Write(image_bytes, 0, nLength)
fStream.Close()
print "Screen image written to screen_image.png."

# Download waveform data.
# -----

# Set the waveform points mode.
scope.SCPi.WAVEform.POINts.MODE.Command("RAW")
qresult = scope.SCPi.WAVEform.POINts.MODE.Query()
print "Waveform points mode: %s" % qresult

# Get the number of waveform points available.
scope.SCPi.WAVEform.POINts.CommandPoints(10240)
qresult = scope.SCPi.WAVEform.POINts.Query1()
print "Waveform points available: %s" % qresult

# Set the waveform source.
scope.SCPi.WAVEform.SOURce.Command("CHANnel1")
qresult = scope.SCPi.WAVEform.SOURce.Query()
print "Waveform source: %s" % qresult

# Choose the format of the data returned:
scope.SCPi.WAVEform.FORMat.Command("BYTE")
qresult = scope.SCPi.WAVEform.FORMat.Query()
print "Waveform format: %s" % qresult

# Display the waveform settings from preamble:
wav_form_dict = {
    0 : "BYTE",
    1 : "WORD",
    4 : "AScii",
}
acq_type_dict = {
    0 : "NORMal",
    1 : "PEAK",
    2 : "AVERage",
    3 : "HRESolution",
}
(

```

```

    wav_form, acq_type, wfmppts, avgcnt, x_increment, x_origin,
    x_reference, y_increment, y_origin, y_reference
) = scope.SCPi.WAVEform.PREamble.Query()

print "Waveform format: %s" % wav_form_dict[int(wav_form)]
print "Acquire type: %s" % acq_type_dict[int(acq_type)]
print "Waveform points desired: %s" % wfmppts
print "Waveform average count: %s" % avgcnt
print "Waveform X increment: %s" % x_increment
print "Waveform X origin: %s" % x_origin
print "Waveform X reference: %s" % x_reference # Always 0.
print "Waveform Y increment: %s" % y_increment
print "Waveform Y origin: %s" % y_origin
print "Waveform Y reference: %s" % y_reference

# Get numeric values for later calculations.
x_increment = scope.SCPi.WAVEform.XINcrement.Query()
x_origin = scope.SCPi.WAVEform.XORigin.Query()
y_increment = scope.SCPi.WAVEform.YINcrement.Query()
y_origin = scope.SCPi.WAVEform.YORigin.Query()
y_reference = scope.SCPi.WAVEform.YREFerence.Query()

# Get the waveform data.
data_bytes = scope.SCPi.WAVEform.DATA.QueryBYTE()
nLength = len(data_bytes)
print "Number of data values: %d" % nLength

# Open file for output.
strPath = "waveform_data.csv"
writer = File.CreateText(strPath)

# Output waveform data in CSV format.
for i in xrange(0, nLength - 1):
    time_val = x_origin + i * x_increment
    voltage = (data_bytes[i] - y_reference) * y_increment + y_origin
    writer.WriteLine("%E, %f" % (time_val, voltage))

# Close output file.
writer.Close()
print "Waveform format BYTE data written to %s." % strPath

# =====
# Main program:
# =====
#addr = "a-mx3054a-60028.cos.keysight.com"
addr = "TCPIP0::a-mx3054a-60028.cos.keysight.com::inst0::INSTR"
scope = AgInfiniiVision4000X(addr)
scope.Transport.DefaultTimeout.Set(10000)

# Initialize the oscilloscope, capture data, and analyze.
initialize()
capture()
analyze()

print "End of program."

```

```
# Wait for a key press before exiting.  
print "Press any key to exit..."  
Console.ReadKey(True)
```

Index

Symbols

???, 820
+9.9E+37, infinity representation, 1391
+9.9E+37, measurement error, 491

Numerics

0 (zero) values in waveform data, 1205
1 (one) values in waveform data, 1205
4000 X-Series oscilloscopes, command differences from, 47
82350B GPIB interface, 6

A

A429 SEARCH commands, 1000
A429 serial bus commands, 760
absolute value math function, 419
AC coupling, trigger edge, 1122
AC input coupling for specified channel, 293
AC RMS measured on waveform, 509, 550
accumulate activity, 217
ACQUIRE commands, 253
acquire data, 225, 265
acquire mode on autoscale, 221
acquire reset conditions, 202, 1069
acquire sample rate, 264
ACQUIRE subsystem, 67
acquired data points, 258
acquisition count, 256
acquisition mode, 253, 257, 1222
acquisition type, 253, 265
acquisition types, 1198
active edges, 217
active printer, 434
activity logic levels, 217
activity on digital channels, 217
add function, 1217
add math function, 418
add math function as g(t) source, 1300
address field size, IIC serial decode, 863
address of network printer, 439
address, IIC trigger pattern, 866
Addresses softkey, 56
AER (Arm Event Register), 218, 237, 239, 1365
Agilent Flash directory, 722, 740
alignment, I2S trigger, 845
all (snapshot) measurement, 492
ALL segments waveform save option, 752
AM demo signal, 326
AM depth, waveform generator modulation, 1250
AM modulation type, waveform generator, 1260
amplitude profile, Control Loop Response (Bode) power analysis, 639
amplitude profile, Power Supply Rejection Ratio (PSRR) power analysis, 680
amplitude, vertical, 505, 543
amplitude, waveform generator, 1269
analog channel coupling, 293
analog channel display, 294
analog channel impedance, 295
analog channel input, 1294
analog channel inversion, 296
analog channel labels, 297, 354
analog channel offset, 298
analog channel protection lock, 1072
analog channel range, 308
analog channel scale, 309
analog channel source for glitch, 1135
analog channel units, 310
analog channels only oscilloscopes, 6
analog probe attenuation, 299
analog probe head type, 300
analog probe sensing, 1295
analog probe skew, 304, 1293
analysis results, save, 741
analyzing captured data, 63
angle brackets, 184
annotate channels, 297
annotation background, display, 345
annotation color, display, 346
annotation text, display, 347
annotation X1 position, 348
annotation Y1 position, 349
annotation, display, 344
apparent power, 562
apply network printer connection settings, 440
arbitrary waveform generator output, 1246
arbitrary waveform, byte order, 1235
arbitrary waveform, capturing from other sources, 1241
arbitrary waveform, clear, 1238
arbitrary waveform, download DAC values, 1239
arbitrary waveform, download floating-point values, 1236
arbitrary waveform, interpolation, 1240
arbitrary waveform, points, 1237
arbitrary waveform, recall, 717
arbitrary waveform, save, 729
area for hardcopy print, 433
area for saved image, 1333
area measurement, 493, 504
ARINC 429 auto setup, 762
ARINC 429 base, 763
ARINC 429 demo signal, 328
ARINC 429 signal speed, 770
ARINC 429 signal type, 768
ARINC 429 source, 769
ARINC 429 trigger data pattern, 772, 1003
ARINC 429 trigger label, 771, 775, 1001
ARINC 429 trigger SDI pattern, 773, 1004
ARINC 429 trigger SSM pattern, 774, 1005
ARINC 429 trigger type, 776, 1002
ARINC 429 word and error counters, reset, 765
ARINC 429 word format, 767
Arm Event Register (AER), 218, 237, 239, 1365
arm event, NFC arm and event trigger, 1137
arming edge slope, Edge Then Edge trigger, 1110
arming edge source, Edge Then Edge trigger, 1111
arrange waveforms, 1297
ASCII format, 1207
ASCII format for data transfer, 1200
ASCII string, quoted, 184
ASCIIX waveform data format, 749
assign channel names, 297
attenuation factor (external trigger) probe, 367
attenuation for oscilloscope probe, 299
audio channel, I2S trigger, 854
AUT option for probe sense, 1295, 1299
Auto Range capability for DVM, 360
auto set up, trigger level, 1103
auto setup (ARINC 429), 762
auto setup for M1553 trigger, 891
auto setup for power analysis signals, 683
auto trigger sweep mode, 1097
automask create, 587
automask source, 588
automask units, 589
automatic measurements constants, 299
automatic probe type detection, 1295, 1299
autoscale, 219
autoscale acquire mode, 221

autoscale channels, 222
 AUToscale command, 66
 autotest for FLEXray event trigger, 836
 autotest for FLEXray decode, 826
 average math function, clear, 402
 average value measurement, 506, 544
 Average, power modulation analysis, 662
 averaged value math function, 419
 averaging acquisition type, 254, 1199
 averaging, synchronizing with, 1380
 Ax + B math function, 418

B

bandwidth filter limits, 366
 bandwidth filter limits to 20 MHz, 292
 bar chart of current harmonics results, 646
 base 10 exponential math function, 419
 base value measurement, 507, 545
 base, ARINC 429, 763
 base, I2S serial decode, 846
 base, MIL-STD-1553 serial decode, 892
 base, SENT decode, 902
 base, UART trigger, 961
 basic instrument functions, 190
 baud rate, 790, 877, 950
 baud rate, CAN FD, 792
 begin acquisition, 225, 246, 248
 BHARRis window for minimal spectral leakage, 389, 411
 binary block data, 184, 351, 1080, 1205
 BINary waveform data format, 749
 bind levels for masks, 608
 bit order, 951
 bit order, SPI decode, 932
 bit rate measurement, 494
 bit selection command, bus, 269
 bit weights, 194
 bitmap display, 351
 bits in Service Request Enable Register, 207
 bits in Standard Event Status Enable Register, 193
 bits in Status Byte Register, 209
 bits selection command, bus, 270
 blank, 224
 block data, 184, 197, 1080
 block response data, 70
 blocking synchronization, 1375
 blocking wait, 1374
 BMP format screen image data, 351
 braces, 183
 built-in measurements, 63
 burst data demo signal, 327
 burst width measurement, 495
 burst, minimum time before next, 1118
 bus bit selection command, 269
 bus bits selection commands, 270
 bus clear command, 272
 bus commands, 268
 BUS data format, 1202

bus display, 273
 bus label command, 274
 bus mask command, 275
 BUS<n> commands, 267
 button disable, 1066
 button, calibration protect, 283
 byte format for data transfer, 1201, 1207
 BYTeorder, 1203

C

C, SICL library example, 1480
 C, VISA library example, 1427
 C#, SCPI.NET example, 1500
 C#, VISA COM example, 1403
 C#, VISA example, 1446
 CAL PROTECT button, 283
 CAL PROTECT switch, 278
 calculating preshoot of waveform, 523
 calculating the waveform overshoot, 517
 calibrate, 279, 280, 283, 287
 CALibrate commands, 277
 calibrate date, 279
 calibrate introduction, 278
 calibrate label, 280
 calibrate output, 281
 calibrate start, 284
 calibrate status, 285
 calibrate switch, 283
 calibrate temperature, 286
 calibrate time, 287
 CAN acknowledge, 789
 CAN and LIN demo signal, 328
 CAN baud rate, 790
 CAN demo signal, 327
 CAN FD baud rate, 792
 CAN FD data triggers, starting byte position, 801
 CAN frame counters, reset, 782
 CAN SEARCh commands, 1006
 CAN serial bus commands, 777
 CAN serial search, data, 1009
 CAN serial search, data length, 1010
 CAN serial search, ID, 1011
 CAN serial search, ID mode, 1012
 CAN serial search, mode, 1007
 CAN signal definition, 791
 CAN source, 793
 CAN symbolic data display, 786
 CAN symbolic data, recall, 718
 CAN trigger, 794, 800
 CAN trigger data pattern, 798
 CAN trigger ID pattern, 802
 CAN trigger pattern id mode, 803
 CAN trigger, ID filter for, 797
 CAN triggering, 755
 capture data, 225
 capturing data, 62
 cardiac waveform generator output, 1245
 center frequency set, 374, 404, 418
 center of screen, 1230
 center screen, FFT vertical value at, 382, 384
 center screen, vertical value at, 417, 423
 center time base reference, 1090
 CFD demo signal, 329
 channel, 252, 297, 1290, 1292
 channel coupling, 293
 channel display, 294
 channel input impedance, 295
 channel inversion, 296
 channel label, 297, 1291
 channel labels, 353, 354
 channel numbers, 1297
 channel overload, 307
 channel protection, 307
 channel reset conditions, 202, 1069
 channel selected to produce trigger, 1135, 1176
 channel signal type, 305
 channel skew for oscilloscope probe, 304, 1293
 channel status, 249, 1297
 channel threshold, 1292
 channel vernier, 311
 channel, stop displaying, 224
 CHANnel<n> commands, 289, 291
 channels to autoscale, 222
 channels, how autoscale affects, 219
 characters to display, 1064
 chart logic bus state math function, 420
 chart logic bus state, clock edge, 398
 chart logic bus state, clock source, 397
 chart logic bus timing math function, 420
 chart logic bus, units, 401
 chart logic bus, value for data = 0, 400
 chart logic bus, value for data increment, 399
 classes of input signals, 389, 411
 classifications, command, 1384
 clear, 350
 clear bus command, 272
 clear cumulative edge variables, 1290
 clear FFT function, 375
 clear markers, 496, 1311
 clear measurement, 496, 1311
 clear message queue, 191
 Clear method, 65
 clear reference waveforms, 1275
 clear screen, 1298
 clear status, 191
 clear waveform area, 342
 clipped high waveform data value, 1205
 clipped low waveform data value, 1205
 clock, 864, 933, 936
 Clock Extension Peripheral Interface (CXPI), 807
 clock period, SENT signal, 900
 clock slope, I2S, 847
 CLOCk source, I2S, 849
 clock source, setup and hold trigger, 1163
 clock timeout, SPI, 934

- clock with infrequent glitch demo signal, 326
- CLS (Clear Status), 191
- CME (Command Error) status bit, 193, 195
- CMOS threshold voltage for digital channels, 339, 1292
- CMOS trigger threshold voltage, 1338
- code, :ACQuire:COMplete, 255
- code, :ACQuire:SEGmented, 261
- code, :ACQuire:TYPE, 266
- code, :AUToscale, 220
- code, :CHANnel<n>:LABel, 297
- code, :CHANnel<n>:PROBe, 299
- code, :CHANnel<n>:RANGe, 308
- code, :DIGitize, 226
- code, :DISPlay:DATA, 351
- code, :DISPlay:LABel, 353
- code, :DISPlay:ORDER, 1297
- code, :MEASure:PERiod, 532
- code, :MEASure:RESults, 525
- code, :MEASure:TEDGe, 540
- code, :MTEST, 583
- code, :POD<n>:THReshold, 619
- code, :RUN/:STOP, 246
- code, :SYSTem:SETup, 1080
- code, :TIMebase:DELay, 1337
- code, :TIMebase:MODE, 1087
- code, :TIMebase:RANGe, 1089
- code, :TIMebase:REFerence, 1090
- code, :TRIGger:MODE, 1106
- code, :TRIGger:SLOPe, 1125
- code, :TRIGger:SOURce, 1126
- code, :VIEW and :BLANK, 252
- code, :WAVeform, 1218
- code, :WAVeform:DATA, 1205
- code, :WAVeform:POINts, 1209
- code, :WAVeform:PREamble, 1213
- code, :WAVeform:SEGmented, 261
- code, *RST, 204
- code, SCPI.NET library example in C#, 1500
- code, SCPI.NET library example in IronPython, 1512
- code, SCPI.NET library example in Visual Basic .NET, 1506
- code, SICL library example in C, 1480
- code, SICL library example in Visual Basic, 1489
- code, VISA COM library example in C#, 1403
- code, VISA COM library example in Python, 1420
- code, VISA COM library example in Visual Basic, 1394
- code, VISA COM library example in Visual Basic .NET, 1412
- code, VISA library example in C, 1427
- code, VISA library example in C#, 1446
- code, VISA library example in Python, 1467, 1473
- code, VISA library example in Visual Basic, 1436
- code, VISA library example in Visual Basic .NET, 1457
- colon, root commands prefixed by, 216
- color palette for hardcopy, 445
- color palette for image, 735
- Comma Separated Values (CSV) waveform data format, 749
- command classifications, 1384
- command differences from 4000 X-Series oscilloscopes, 47
- command errors detected in Standard Event Status, 195
- Command Expert, 1500
- command header, 1385
- command headers, common, 1387
- command headers, compound, 1387
- command headers, simple, 1387
- command strings, valid, 1385
- commands quick reference, 75
- commands sent over interface, 190
- commands, more about, 1383
- commands, obsolete and discontinued, 1283
- common (*) commands, 3, 187, 190
- common command headers, 1387
- common logarithm math function, 419
- completion criteria for an acquisition, 255, 256
- compound command headers, 1387
- compound header, 1389
- computer control examples, 1393
- conditions for external trigger, 365
- conditions, reset, 202, 1069
- conduction calculation method for switching loss, 705
- Config softkey, 56
- configurations, oscilloscope, 197, 201, 205, 1080
- Configure softkey, 56
- connect oscilloscope, 55
- connect sampled data points, 1296
- Connection Expert, 57
- constants for making automatic measurements, 299
- constants for scaling display factors, 299
- constants for setting trigger levels, 299
- Control Loop Response (Bode) power analysis settings, 628
- control loop response (Bode) power analysis, apply, 629
- control loop response power analysis, sweep start frequency, 632
- control loop response power analysis, sweep stop frequency, 633
- controller initialization, 62
- conversion type of power supply, 659
- copy display, 245
- copyright, 2
- core commands, 1384
- count, 1204
- count totalize, gating enable/disable, 321
- count values, 256
- count, averaged value math function, 396
- count, averages, FFT function, 373
- count, Edge Then Edge trigger, 1113
- count, Nth edge of burst, 1117
- counter, 314, 497
- counter commands, 313
- counter mode, 317
- counter source, 319
- counter totalize, clear, 320
- counter totalize, gating polarity, 322
- counter totalize, gating signal source, 323
- counter totalize, slope, 324
- counter, digits of resolution, 318
- counter, enable/disable, 316
- coupling, 1122
- COUPLing demo signal, 329
- coupling for channels, 293
- CRC format, SENT, 901
- create automask, 587
- crest factor, 564
- CSV (Comma Separated Values) waveform data format, 749
- CT bits (CXPI), triggering on, 821
- cumulative edge activity, 1290
- current harmonics analysis fail count, 647
- current harmonics analysis results, save, 739
- current harmonics analysis run count, 652
- current harmonics analysis, apply, 644
- current harmonics results data, 645
- current harmonics results display, 646
- current logic levels on digital channels, 217
- current oscilloscope configuration, 197, 201, 205, 1080
- current probe, 310, 369
- CURRent segment waveform save option, 752
- current source, 700
- cursor display setting, X1, 458
- cursor display setting, X2, 461
- cursor display setting, Y1, 467
- cursor display setting, Y2, 469
- cursor mode, 457
- cursor position, 456, 459, 462, 464, 468, 471
- cursor readout, 1312, 1316, 1317
- cursor reset conditions, 202, 1069
- cursor source, 460, 463
- cursor time, 1312, 1316, 1317
- cursor units, X, 465, 466
- cursor units, Y, 472, 473
- cursor values, saving, 742
- cursor track measurements, 530
- cursor, how autoscale affects, 219
- cursor, X1, X2, Y1, Y2, 455
- custom time base reference, 1090
- custom time base reference location, 1091
- CXPI frame data value, 817
- CXPI parity bit display, 810
- CXPI serial bus commands, 807
- CXPI signal baud rate, 809

CXPI signal source, [811](#)
 CXPI signal tolerance, [812](#)
 CXPI trigger mode, [813](#)
 CXPI triggering, [755](#)
 cycle count base, FLEXray frame trigger, [839](#)
 cycle count repetition, FLEXray frame trigger, [840](#)
 cycle measured, [510](#), [513](#)
 cycle time, [520](#)
 cycles analyzed, number of, [684](#), [685](#)

D

D- source, [1183](#)
 D+ source, [1184](#)
 data, [865](#), [867](#), [1205](#)
 data (waveform) maximum length, [751](#)
 data 2, [868](#)
 data acquisition types, [1198](#)
 data conversion, [1199](#)
 data format for transfer, [1200](#)
 data output order, [1203](#)
 data pattern length, [800](#), [885](#)
 data pattern, ARINC 429 trigger, [772](#), [1003](#)
 data pattern, CAN trigger, [798](#)
 data point index, [1227](#)
 data points, [258](#)
 data record, measurement, [1210](#)
 data record, raw acquisition, [1210](#)
 data required to fill time buckets, [255](#)
 DATA source, I2S, [850](#)
 data source, setup and hold trigger, [1164](#)
 data structures, status reporting, [1351](#)
 data, saving and recalling, [342](#)
 date, calibration, [279](#)
 date, system, [1063](#)
 DC coupling for edge trigger, [1122](#)
 DC input coupling for specified channel, [293](#)
 DC offset correction for integrate input, [414](#)
 DC RMS measured on waveform, [509](#), [550](#)
 DC waveform generator output, [1244](#)
 DCMotor demo signal, [328](#)
 DDE (Device Dependent Error) status bit, [193](#), [195](#)
 decision chart, status reporting, [1371](#)
 default conditions, [202](#), [1069](#)
 define channel labels, [297](#)
 define glitch trigger, [1133](#)
 define logic thresholds, [1292](#)
 define measurement, [500](#)
 define measurement source, [531](#)
 define trigger, [1134](#), [1152](#), [1153](#), [1155](#)
 defined as, [183](#)
 definite-length block query response, [70](#)
 definite-length block response data, [184](#)
 delay measured to calculate phase, [521](#)
 delay measurement, [500](#)

delay measurements, [539](#)
 delay parameters for measurement, [502](#)
 delay time, Edge Then Edge trigger, [1112](#)
 DELay trigger commands, [1109](#)
 delay, how autoscale affects, [219](#)
 delayed time base, [1087](#)
 delayed window horizontal scale, [1096](#)
 delete mask, [597](#)
 delta time, [1312](#)
 delta voltage measurement, [1320](#)
 delta X cursor, [455](#)
 delta Y cursor, [455](#)
 demo, [325](#)
 DEMO commands, [325](#)
 demo signal, [327](#)
 demo signal function, [326](#)
 demo signal phase angle, [330](#)
 demo signals output control, [331](#)
 deskew for power measurements, [640](#)
 destination, remote command logging, [1074](#)
 detecting probe types, [1295](#), [1299](#)
 device-defined error queue clear, [191](#)
 DIFF source for function, [1303](#)
 differences from 4000 X-Series oscilloscope commands, [47](#)
 differential probe heads, [300](#)
 differential signal type, [305](#)
 differentiate math function, [418](#), [1217](#)
 digital channel commands, [334](#), [335](#), [336](#), [337](#), [339](#)
 digital channel data, [1201](#)
 digital channel labels, [354](#)
 digital channel order, [1297](#)
 digital channel source for glitch trigger, [1135](#)
 digital channels, [6](#)
 digital channels, activity and logic levels on, [217](#)
 digital channels, groups of, [615](#), [617](#), [619](#)
 digital pod, stop displaying, [224](#)
 digital reset conditions, [203](#), [1070](#)
 DIGital<d> commands, [333](#)
 digitize channels, [225](#)
 DIGitize command, [62](#), [67](#), [1198](#)
 digits, [184](#)
 disable front panel, [1066](#)
 disable function, [1304](#)
 disabling calibration, [283](#)
 disabling channel display, [294](#)
 disabling status register bits, [192](#), [206](#)
 discontinued and obsolete commands, [1283](#)
 display annotation, [344](#)
 display annotation background, [345](#)
 display annotation color, [346](#)
 display annotation text, [347](#)
 display channel labels, [353](#)
 display clear, [350](#)
 DISPLAY commands, [341](#)
 display commands introduction, [342](#)
 display connect, [1296](#)

display date, [1063](#)
 display factors scaling, [299](#)
 display for channels, [294](#)
 display frequency span, [387](#), [409](#)
 display measurements, [490](#), [530](#)
 display mode, FFT, [377](#)
 display order, [1297](#)
 display persistence, [357](#)
 display reference, [1088](#)
 display reference waveforms, [1276](#)
 display reset conditions, [203](#), [1070](#)
 display serial number, [247](#)
 display vectors, [358](#)
 display wave position, [1297](#)
 display, FFT function, [376](#)
 display, lister, [451](#)
 display, measurement statistics on/off, [534](#)
 display, oscilloscope, [335](#), [357](#), [403](#), [617](#), [1064](#)
 display, serial decode bus, [758](#)
 displaying a baseline, [1108](#)
 displaying unsynchronized signal, [1108](#)
 divide math function, [418](#)
 DLC data length code (CXPI), triggering on, [822](#)
 DLC value in CAN FD trigger, [799](#)
 DNS IP, [56](#)
 domain, [56](#)
 domain, network printer, [441](#)
 driver, printer, [1309](#)
 DSO models, [6](#)
 duplicate mnemonics, [1389](#)
 duration, [1152](#), [1153](#), [1155](#)
 duration for glitch trigger, [1129](#), [1130](#), [1134](#)
 duration of power analysis, [686](#), [687](#), [688](#), [689](#), [690](#), [691](#)
 duration qualifier, trigger, [1152](#), [1153](#)
 duration triggering, [1098](#)
 duty cycle measurement, [63](#), [490](#), [510](#), [513](#)
 Duty Cycle, power modulation analysis, [662](#)
 DVM commands, [359](#)
 DVM displayed value, [361](#)
 DVM enable/disable, [362](#)
 DVM input source, [364](#)
 DVM mode, [363](#)

E

EBURst trigger commands, [1116](#)
 ECL channel threshold, [1292](#)
 ECL threshold voltage for digital channels, [339](#)
 ECL trigger threshold voltage, [1338](#)
 edge activity, [1290](#)
 edge counter, Edge Then Edge trigger, [1113](#)
 edge counter, Nth edge of burst, [1117](#)
 edge coupling, [1122](#)

- edge fall time, [511](#)
 - edge parameter for delay measurement, [502](#)
 - edge preshoot measured, [523](#)
 - edge rise time, [528](#)
 - EDGE SEARCh commands, [975](#)
 - edge search slope, [976](#)
 - edge search source, [977](#)
 - edge slope, [1125](#)
 - edge source, [1126](#)
 - edge string for OR'ed edge trigger, [1147](#)
 - EDGE trigger commands, [1121](#)
 - edge triggering, [1098](#)
 - edges (activity) on digital channels, [217](#)
 - edges in measurement, [500](#)
 - efficiency, [565](#)
 - efficiency power analysis, apply, [641](#)
 - elapsed time in mask test, [594](#)
 - ellipsis, [184](#)
 - enable channel labels, [353](#)
 - enabling calibration, [283](#)
 - enabling channel display, [294](#)
 - enabling status register bits, [192, 206](#)
 - end of string (EOS) terminator, [1386](#)
 - end of text (EOT) terminator, [1386](#)
 - end or identify (EOI), [1386](#)
 - energy loss, [566](#)
 - envelope math function, [419](#)
 - EOI (end or identify), [1386](#)
 - EOS (end of string) terminator, [1386](#)
 - EOT (end of text) terminator, [1386](#)
 - erase data, [350](#)
 - erase measurements, [1311](#)
 - erase screen, [1298](#)
 - error counter (ARINC 429), [764](#)
 - error counter (ARINC 429), reset, [765](#)
 - error frame count (CAN), [780](#)
 - error frame count (UART), [952](#)
 - error messages, [1065, 1341](#)
 - error number, [1065](#)
 - error queue, [1065, 1362](#)
 - error, measurement, [490](#)
 - ESB (Event Status Bit), [207, 209](#)
 - ESE (Standard Event Status Enable Register), [192, 1361](#)
 - ESR (Standard Event Status Register), [194, 1360](#)
 - ETE demo signal, [327](#)
 - event status conditions occurred, [209](#)
 - Event Status Enable Register (ESE), [192, 1361](#)
 - Event Status Register (ESR), [194, 251, 1360](#)
 - example code, :ACQuire:COMPLete, [255](#)
 - example code, :ACQuire:SEGMENTed, [261](#)
 - example code, :ACQuire:TYPE, [266](#)
 - example code, :AUToscale, [220](#)
 - example code, :CHANnel<n>:LABel, [297](#)
 - example code, :CHANnel<n>:PROBe, [299](#)
 - example code, :CHANnel<n>:RANGe, [308](#)
 - example code, :DIGitize, [226](#)
 - example code, :DISPlay:DATA, [351](#)
 - example code, :DISPlay:LABel, [353](#)
 - example code, :DISPlay:ORDer, [1297](#)
 - example code, :MEASure:PERiod, [532](#)
 - example code, :MEASure:RESults, [525](#)
 - example code, :MEASure:TEDGe, [540](#)
 - example code, :MTEST, [583](#)
 - example code, :POD<n>:THReshold, [619](#)
 - example code, :RUN:/STOP, [246](#)
 - example code, :SYSTem:SETup, [1080](#)
 - example code, :TiMEbase:DELAy, [1337](#)
 - example code, :TiMEbase:MODE, [1087](#)
 - example code, :TiMEbase:RANGe, [1089](#)
 - example code, :TiMEbase:REFeRence, [1090](#)
 - example code, :TRIGger:MODE, [1106](#)
 - example code, :TRIGger:SLOPe, [1125](#)
 - example code, :TRIGger:SOURce, [1126](#)
 - example code, :VIEW and :BLANK, [252](#)
 - example code, :WAVEform, [1218](#)
 - example code, :WAVEform:DATA, [1205](#)
 - example code, :WAVEform:POINts, [1209](#)
 - example code, :WAVEform:PREAmble, [1213](#)
 - example code, :WAVEform:SEGMENTed, [261](#)
 - example code, *RST, [204](#)
 - example programs, [6, 1393](#)
 - excursion delta for FFT peak search, [986](#)
 - EXE (Execution Error) status bit, [193, 195](#)
 - execution error detected in Standard Event Status, [195](#)
 - exponential fall waveform generator output, [1245](#)
 - exponential math function, [419](#)
 - exponential notation, [183](#)
 - exponential rise waveform generator output, [1245](#)
 - extended video triggering license, [1177](#)
 - external glitch trigger source, [1135](#)
 - external range, [368](#)
 - external trigger, [365, 367, 1126](#)
 - EXTERNAL trigger commands, [365](#)
 - EXTERNAL trigger level, [1123](#)
 - external trigger probe attenuation factor, [367](#)
 - external trigger probe sensing, [1299](#)
 - EXTERNAL trigger source, [1126](#)
 - external trigger units, [369](#)
- ## F
- fail count, current harmonics analysis, [647](#)
 - fail/pass status (overall) for current harmonics analysis, [654](#)
 - failed waveforms in mask test, [592](#)
 - failure, self test, [211](#)
 - fall time measurement, [490, 511](#)
 - Fall Time, power modulation analysis, [662](#)
 - falling edge count measurement, [514](#)
 - falling pulse count measurement, [515](#)
 - FAST data, SENT, [1221](#)
 - Fast Fourier Transform (FFT) functions, [374, 387, 389, 404, 409, 411, 418, 1303](#)
 - FF values in waveform data, [1205](#)
 - FFT (Fast Fourier Transform) functions, [374, 387, 389, 404, 409, 411, 418, 1303](#)
 - FFT (Fast Fourier Transform) operation, [1217](#)
 - FFT display mode, [377](#)
 - FFT function display, [376](#)
 - FFT function, source input, [386](#)
 - FFT vertical units, [388, 410](#)
 - FFTPhase (Fast Fourier Transform) functions, [418](#)
 - fifty ohm impedance, disable setting, [1072](#)
 - filename for hardcopy, [1306](#)
 - filename for recall, [719, 1242](#)
 - filename for save, [730](#)
 - filter CXPI trigger by ID, [815](#)
 - filter for frequency reject, [1124](#)
 - filter for high frequency reject, [1101](#)
 - filter for noise reject, [1107](#)
 - filter used to limit bandwidth, [292, 366](#)
 - filters to Fast Fourier Transforms, [389, 411](#)
 - filters, math, [419](#)
 - fine horizontal adjustment (vernier), [1093](#)
 - fine vertical adjustment (vernier), [311](#)
 - finish pending device operations, [198](#)
 - first point displayed, [1227](#)
 - FLATtop window for amplitude measurements, [389, 411](#)
 - FLEXray autoseg for event trigger, [836](#)
 - FLEXray autoseg, [826](#)
 - FlexRay demo signal, [328](#)
 - FlexRay frame counters, reset, [830](#)
 - FLEXray SEARCh commands, [1016](#)
 - FlexRay serial search, cycle, [1017](#)
 - FlexRay serial search, data, [1018](#)
 - FlexRay serial search, data length, [1019](#)
 - FlexRay serial search, frame, [1020](#)
 - FlexRay serial search, mode, [1021](#)
 - FLEXray source, [833](#)
 - FLEXray trigger, [834](#)
 - FLEXray trigger commands, [824](#)
 - FM burst demo signal, [327](#)
 - FM modulation type, waveform generator, [1260](#)
 - force trigger, [1100](#)
 - format, [1207, 1212](#)
 - format (word), ARINC 429, [767](#)
 - format for block data, [197](#)
 - format for generic video, [1173, 1177](#)
 - format for hardcopy, [1305](#)
 - format for image, [733](#)
 - format for waveform data, [749](#)
 - FormattedIO488 object, [65](#)
 - formfeed for hardcopy, [432, 436](#)
 - formulas for data conversion, [1199](#)
 - frame, [937](#)
 - frame counters (CAN), error, [780](#)
 - frame counters (CAN), overload, [781](#)
 - frame counters (CAN), reset, [782](#)

frame counters (CAN), total, **784**
 frame counters (FlexRay), null, **829, 831**
 frame counters (FlexRay), reset, **830**
 frame counters (FlexRay), total, **832**
 frame counters (UART), error, **952**
 frame counters (UART), reset, **953**
 frame counters (UART), Rx frames, **954**
 frame counters (UART), Tx frames, **955**
 frame ID, FLEXray BSS event trigger, **837**
 frame ID, FLEXray frame trigger, **841**
 frame type, FLEXray frame trigger, **842**
 framing, **935**
 frequency deviation, waveform generator FM modulation, **1252**
 frequency measurement, **63, 490, 512**
 frequency measurements with X cursors, **465**
 frequency mode, Control Loop Response (Bode) power analysis, **631**
 frequency mode, Power Supply Rejection Ratio (PSRR) power analysis, **674**
 frequency resolution, **389, 411**
 frequency span of display, **387, 409**
 Frequency, power modulation analysis, **662**
 front panel mode, **1108**
 front panel Single key, **248**
 front panel Stop key, **250**
 front-panel lock, **1066**
 FSK modulation type, waveform generator, **1260**
 FSK rate, waveform generator modulation, **1255**
 FT commands, **371**
 full-scale horizontal time, **1089, 1095**
 full-scale vertical axis defined, **383, 422**
 function, **374, 387, 389, 403, 404, 409, 411, 417, 418, 422, 423, 424, 1303, 1304**
 FUNCTION commands, **391**
 function memory, **249**
 function turned on or off, **1304**
 function, demo signal, **326**
 function, first source input, **426**
 function, second source input, **428**
 function, waveform generator, **1243**
 functions, **1217**

G

g(t) source, first input channel, **1301**
 g(t) source, math operation, **1300**
 g(t) source, second input channel, **1302**
 gain for Ax + B math operation, **415**
 gated measurement window, **553**
 gateway IP, **56**
 gating, FFT math function, **381, 407**
 gaussian pulse waveform generator output, **1245**
 general SBUS<n> commands, **757**
 general SEARCh commands, **970**
 general trigger commands, **1099**

GENeric, **1173, 1177**
 generic video format, **1173, 1177**
 Generic video trigger, edge number, **1178**
 Generic video trigger, greater than sync pulse width time, **1181**
 Generic video trigger, horizontal sync control, **1179**
 Generic video trigger, horizontal sync pulse time, **1180**
 glitch demo signal, **326**
 glitch duration, **1134**
 glitch qualifier, **1133**
 GLITCh SEARCh commands, **978**
 glitch search, greater than value, **979**
 glitch search, less than value, **980**
 glitch search, polarity, **981**
 glitch search, qualifier, **982**
 glitch search, range, **983**
 glitch search, source, **984**
 glitch source, **1135**
 GLITCh trigger commands, **1127**
 glitch trigger duration, **1129**
 glitch trigger polarity, **1132**
 glitch trigger source, **1129**
 GPIB interface, **56**
 graticule area for hardcopy print, **433**
 graticule colors, invert for hardcopy, **437, 1308**
 graticule colors, invert for image, **734**
 grayscale palette for hardcopy, **445**
 grayscale palette for image, **735**
 grayscale on hardcopy, **1307**
 greater than qualifier, **1133**
 greater than time, **1129, 1134, 1152, 1155**
 greater than value for glitch search, **979**
 groups of digital channels, **615, 617, 619, 1292**

H

HANNing window for frequency resolution, **389, 411**
 hardcopy, **245, 432**
 HARDcopy commands, **431**
 hardcopy factors, **435, 732**
 hardcopy filename, **1306**
 hardcopy format, **1305**
 hardcopy formfeed, **436**
 hardcopy grayscale, **1307**
 hardcopy invert graticule colors, **437, 1308**
 hardcopy layout, **438**
 hardcopy palette, **445**
 hardcopy print, area, **433**
 hardcopy printer driver, **1309**
 Hardware Event Condition Register (:HWERegister:CONDition), **229**
 Hardware Event Condition Register (:OPERRegister:CONDition), **1368**
 Hardware Event Enable Register (HWEEnable), **227**
 Hardware Event Event Register (:HWERegister[:EVENT]), **230, 1367**
 HARMonics demo signal, **329**
 head type, probe, **300**
 header, **1385**
 high pass filter math function, **419**
 high resolution acquisition type, **1199**
 high trigger level, **1104**
 high-frequency reject filter, **1101, 1124**
 high-level voltage, waveform generator, **1270**
 high-pass filter cutoff frequency, **412**
 high-resolution acquisition type, **254**
 hold time, setup and hold trigger, **1165**
 hold until operation complete, **198**
 holdoff time, **1102**
 holes in waveform data, **1205**
 hop frequency, waveform generator FSK modulation, **1254**
 horizontal adjustment, fine (vernier), **1093**
 horizontal position, **1094**
 horizontal scale, **1092, 1096**
 horizontal scaling, **1212**
 horizontal time, **1089, 1095, 1312**
 Host name softkey, **56**
 hostname, **56**
 HWEEnable (Hardware Event Enable Register), **227**
 HWERegister:CONDition (Hardware Event Condition Register), **229, 1368**
 HWERegister[:EVENT] (Hardware Event Event Register), **230, 1367**

I

I1080L50HZ, **1173, 1177**
 I1080L60HZ, **1173, 1177**
 I2C demo signal, **327**
 I2S alignment, **845**
 I2S audio channel, **854**
 I2S clock slope, **847**
 I2S CLOCk source, **849**
 I2S DATA source, **850**
 I2S demo signal, **328**
 I2S pattern data, **855**
 I2S pattern format, **857**
 I2S range, **858**
 I2S receiver width, **848**
 I2S SEARCh commands, **1022**
 I2S serial bus commands, **843**
 I2S serial decode base, **846**
 I2S serial search, audio channel, **1023**
 I2S serial search, data, **1025**
 I2S serial search, format, **1026**
 I2S serial search, mode, **1024**
 I2S serial search, range, **1027**
 I2S transmit word size, **860**
 I2S trigger operator, **852**
 I2S triggering, **756**

- I2S word select (WS) low, 861
 - I2S word select (WS) source, 851
 - ID filter for CAN trigger, 797
 - id mode, 803
 - ID pattern, CAN trigger, 802
 - identification number, 196
 - identification of options, 199
 - identifier, LIN, 882
 - idle, 1118
 - idle state, SENT bus, 906
 - idle until operation complete, 198
 - IDN (Identification Number), 196
 - IEC 61000-3-2 standard for current harmonics analysis, 653
 - IEEE 488.2 standard, 190
 - IIC address, 866
 - IIC clock, 864
 - IIC data, 865, 867
 - IIC data 2, 868
 - IIC SEARCh commands, 1028
 - IIC serial decode address field size, 863
 - IIC serial search, address, 1031
 - IIC serial search, data, 1032
 - IIC serial search, data2, 1033
 - IIC serial search, mode, 1029
 - IIC serial search, qualifier, 1034
 - IIC trigger commands, 862
 - IIC trigger qualifier, 869
 - IIC trigger type, 870
 - IIC triggering, 756
 - image format, 733
 - image invert graticule colors, 734
 - image memory, 249
 - image palette, 735
 - image, save, 731
 - image, save with inksaver, 734
 - impedance, 295
 - infinity representation, 1391
 - initial load current, transient response analysis, 712
 - initialization, 62, 65
 - initialize, 202, 1069
 - initialize label list, 354
 - initiate acquisition, 225
 - inksaver, save image with, 734
 - input coupling for channels, 293
 - input for integrate, DC offset correction, 414
 - input impedance for channels, 295, 1294
 - input inversion for specified channel, 296
 - input power, 568
 - input source, Control Loop Response (Bode) power analysis, 635
 - input source, Power Supply Rejection Ratio (PSRR) power analysis, 676
 - inrush current, 572
 - inrush current analysis, 656, 657, 658
 - inrush current expected, 692
 - insert label, 297
 - installed options identified, 199
 - instruction header, 1385
 - instrument number, 196
 - instrument options identified, 199
 - instrument requests service, 209
 - instrument serial number, 247
 - instrument settings, 432
 - instrument status, 72
 - instrument type, 196
 - integrate DC offset correction, 414
 - integrate math function, 418, 1217
 - INTEgrate source for function, 1303
 - intensity, waveform, 352
 - internal low-pass filter, 292, 366
 - introduction to :ACQuire commands, 253
 - introduction to :BUS<n> commands, 268
 - introduction to :CALibrate commands, 278
 - introduction to :CHANnel<n> commands, 291
 - introduction to :COUNter commands, 314
 - introduction to :DEMO commands, 325
 - introduction to :DIGIT<d> commands, 334
 - introduction to :DISPlay commands, 342
 - introduction to :EXTernal commands, 365
 - introduction to :FFT commands, 372
 - introduction to :FUNction commands, 395
 - introduction to :HARDcopy commands, 432
 - introduction to :LISTer commands, 449
 - introduction to :MARKer commands, 455
 - introduction to :MEASure commands, 490
 - introduction to :POD<n> commands, 615
 - introduction to :RECall commands, 716
 - introduction to :SAVE commands, 727
 - introduction to :SBUS commands, 755
 - introduction to :SYSTEM commands, 1062
 - introduction to :TIMEbase commands, 1086
 - introduction to :TRIGger commands, 1097
 - introduction to :WAVEform commands, 1197
 - introduction to :WGEN<w> commands, 1234
 - introduction to :WMEMory<r> commands, 1273
 - introduction to common (*) commands, 190
 - introduction to root (:) commands, 216
 - invert graticule colors for hardcopy, 437, 1308
 - invert graticule colors for image, 734
 - inverted masks, bind levels, 608
 - inverting input for channels, 296
 - IO library, referencing, 64
 - IP address, 56
 - IronPython, SCPI.NET example, 1512
- ## K
- key disable, 1066
 - key press detected in Standard Event Status Register, 195
 - KEYSight demo signal, 329
 - Keysight Interactive IO application, 59
 - Keysight IO Control icon, 57
 - Keysight IO Libraries Suite, 6, 53, 64, 66
 - Keysight IO Libraries Suite, installing, 54
 - knob disable, 1066
 - known state, 202, 1069
- ## L
- label, 1291
 - label command, bus, 274
 - label list, 297, 354
 - label reference waveforms, 1277
 - label, ARINC 429 trigger, 771, 775, 1001
 - label, digital channel, 336
 - labels, 297, 353, 354
 - labels to store calibration information, 280
 - labels, specifying, 342
 - LAN instrument, 58
 - LAN interface, 55, 57
 - LAN Settings softkey, 56
 - landscape layout for hardcopy, 438
 - language for program examples, 61
 - layout for hardcopy, 438
 - leakage into peak spectrum, 389, 411
 - learn string, 197, 1080
 - least significant byte first, 1203
 - left time base reference, 1090
 - legal values for channel offset, 298
 - legal values for frequency span, 387, 409
 - legal values for offset, 417, 423
 - length for waveform data, 750
 - length of data, CXPI trigger, 818
 - less than qualifier, 1133
 - less than time, 1130, 1134, 1153, 1155
 - less than value for glitch search, 980
 - level for trigger voltage, 1123, 1131
 - LF coupling, 1122
 - license information, 199
 - limits for line number, 1173
 - LIN acknowledge, 876
 - LIN baud rate, 877
 - LIN demo signal, 327
 - LIN identifier, 882
 - LIN pattern data, 883
 - LIN pattern format, 886
 - LIN SEARCh commands, 1035
 - LIN serial decode bus parity bits, 875
 - LIN serial search, data, 1038
 - LIN serial search, data format, 1040
 - LIN serial search, data length, 1039
 - LIN serial search, frame ID, 1036
 - LIN serial search, mode, 1037
 - LIN source, 878
 - LIN standard, 879
 - LIN symbolic data display, 874
 - LIN symbolic data, recall, 720
 - LIN sync break, 880
 - LIN trigger, 881, 885
 - LIN trigger commands, 872
 - LIN trigger definition, 1334

- LIN triggering, 756
 - line frequency setting for current harmonics analysis, 648
 - line glitch trigger source, 1135
 - line number for TV trigger, 1173
 - line terminator, 183
 - LINE trigger level, 1123
 - LINE trigger source, 1126
 - list of channel labels, 354
 - LISTer commands, 449
 - lister display, 451
 - lister time reference, 452
 - ln math function, 419
 - load utilization (CAN), 785
 - local lockout, 1066
 - location, custom time base reference location, 1091
 - lock, 1066
 - lock mask to signal, 599
 - lock, analog channel protection, 1072
 - lockout message, 1066
 - log file name, remote command logging, 1073, 1076
 - log math function, 419
 - logic level activity, 1290
 - long form, 1386
 - low frequency sine with glitch demo signal, 327
 - low pass filter math function, 419
 - low trigger level, 1105
 - lower threshold, 520
 - lower threshold voltage for measurement, 1310
 - lowercase characters in commands, 1385
 - low-frequency reject filter, 1124
 - low-level voltage, waveform generator, 1271
 - low-pass filter cutoff frequency, 413
 - low-pass filter used to limit bandwidth, 292, 366
 - LRN (Learn Device Setup), 197
 - lsbfirst, 1203
- ## M
- M1553 SEARCh commands, 1044
 - M1553 trigger commands, 890
 - M1553 trigger type, 896
 - magnify math function, 420
 - magnitude of occurrence, 541
 - main sweep range, 1094
 - main time base, 1337
 - main time base mode, 1087
 - making measurements, 490
 - MAN option for probe sense, 1295, 1299
 - manual cursor mode, 457
 - manufacturer string, 1067, 1068
 - MARKer commands, 453
 - marker mode, 468
 - marker position, 470
 - marker readout, 1316, 1317
 - marker set for voltage measurement, 1321, 1322
 - marker sets start time, 1313
 - marker time, 1312
 - markers for delta voltage measurement, 1320
 - markers track measurements, 530
 - markers, command overview, 455
 - markers, mode, 457
 - markers, time at start, 1317
 - markers, time at stop, 1316
 - markers, X delta, 456, 464
 - markers, X1 position, 459
 - markers, X1Y1 source, 460
 - markers, X2 position, 462
 - markers, X2Y2 source, 463
 - markers, Y delta, 471
 - markers, Y1 position, 468
 - markers, Y2 position, 470
 - mask, 192, 206
 - mask command, bus, 275
 - mask statistics, reset, 593
 - mask statistics, saving, 743
 - mask test commands, 581
 - Mask Test Event Enable Register (MTEenable), 231
 - mask test event event register, 233
 - Mask Test Event Event Register (:MTERegister[:EVENT]), 233, 1369
 - mask test run mode, 600
 - mask test termination conditions, 600
 - mask test, all channels, 586
 - mask test, enable/disable, 598
 - mask, delete, 597
 - mask, get as binary block data, 596
 - mask, load from binary block data, 596
 - mask, lock to signal, 599
 - mask, recall, 721
 - mask, save, 736, 737
 - masks, bind levels, 608
 - master summary status bit, 209
 - math filters, 419
 - math function, stop displaying, 224
 - math operators, 418
 - math transforms, 418
 - math visualizations, 420
 - MAV (Message Available), 191, 207, 209
 - max hold math function, 420
 - maximum duration, 1130, 1152, 1153
 - maximum math function, 420
 - maximum number of peaks for FFT peak search, 987
 - maximum position, 1088
 - maximum range for zoomed window, 1095
 - maximum scale for zoomed window, 1096
 - maximum vertical value measurement, 546
 - maximum vertical value, time of, 554, 1314
 - maximum waveform data length, 751
 - MEASure commands, 475
 - measure mask test failures, 601
 - measure overshoot, 517
 - measure period, 520
 - measure phase between channels, 521
 - MEASure power commands, 557
 - measure preshoot, 523
 - measure start voltage, 1321
 - measure stop voltage, 1322
 - measure value at a specified time, 551
 - measure value at top of waveform, 552
 - measurement error, 490
 - measurement record, 1210
 - measurement results, saving, 744
 - measurement setup, 490, 531
 - measurement source, 531
 - measurement statistics results, 525
 - measurement statistics, display on/off, 534
 - measurement trend math function, 420
 - measurement window, 553
 - measurements, AC RMS, 509, 550
 - measurements, area, 493, 504
 - measurements, average value, 506, 544
 - measurements, base value, 507, 545
 - measurements, built-in, 63
 - measurements, burst width, 495
 - measurements, clear, 496, 1311
 - measurements, command overview, 490
 - measurements, counter, 497
 - measurements, DC RMS, 509, 550
 - measurements, definition setup, 500
 - measurements, delay, 502
 - measurements, fall time, 511
 - measurements, falling edge count, 514
 - measurements, falling pulse count, 515
 - measurements, frequency, 512
 - measurements, how autoscale affects, 219
 - measurements, lower threshold level, 1310
 - measurements, maximum vertical value, 546
 - measurements, maximum vertical value, time of, 554, 1314
 - measurements, minimum vertical value, 547
 - measurements, minimum vertical value, time of, 555, 1315
 - measurements, negative duty cycle, 513
 - measurements, overshoot, 517
 - measurements, period, 520
 - measurements, phase, 521
 - measurements, positive duty cycle, 510
 - measurements, preshoot, 523
 - measurements, pulse width, negative, 516
 - measurements, pulse width, positive, 524
 - measurements, ratio of AC RMS values, 549
 - measurements, rise time, 528
 - measurements, rising edge count, 519
 - measurements, rising pulse count, 522
 - measurements, show, 530
 - measurements, snapshot all, 492
 - measurements, source channel, 531
 - measurements, standard deviation, 529
 - measurements, start marker time, 1316
 - measurements, stop marker time, 1317

measurements, thresholds, [1313](#)
 measurements, time between start and stop markers, [1312](#)
 measurements, time between trigger and edge, [539](#)
 measurements, time between trigger and vertical value, [541](#)
 measurements, time between trigger and voltage level, [1318](#)
 measurements, upper threshold value, [1319](#)
 measurements, vertical amplitude, [505](#), [543](#)
 measurements, vertical peak-to-peak, [508](#), [548](#)
 measurements, voltage difference, [1320](#)
 memory setup, [205](#), [1080](#)
 menu, display, [355](#)
 menu, system, [1336](#)
 message available bit, [209](#)
 message available bit clear, [191](#)
 message decode/triggering format, SENT, [904](#)
 message displayed, [209](#)
 message error, [1341](#)
 message queue, [1359](#)
 message, CAN symbolic search, [1013](#)
 message, CAN symbolic trigger, [804](#)
 message, LIN symbolic search, [1041](#)
 message, LIN symbolic trigger, [887](#)
 messages ready, [209](#)
 midpoint of thresholds, [520](#)
 MIL-STD-1553 demo signal, [328](#)
 MIL-STD-1553 serial decode base, [892](#)
 MIL-STD-1553 serial search, data, [1046](#)
 MIL-STD-1553 serial search, mode, [1045](#)
 MIL-STD-1553 serial search, Remote Terminal Address, [1047](#)
 MIL-STD-1553, dual demo signal, [328](#)
 min hold math function, [420](#)
 minimum duration, [1129](#), [1152](#), [1153](#), [1155](#)
 minimum math function, [420](#)
 minimum vertical value measurement, [547](#)
 minimum vertical value, time of, [555](#), [1315](#)
 MISO data pattern width, [941](#)
 MISO data pattern, SPI trigger, [940](#)
 MISO data source, SPI trigger, [938](#)
 MISO data, SPI, [1221](#)
 mixed-signal demo signals, [327](#)
 mixed-signal oscilloscopes, [6](#)
 mnemonics, duplicate, [1389](#)
 mode, [457](#), [1087](#), [1174](#)
 mode, serial decode, [759](#)
 model number, [196](#)
 models, oscilloscope, [3](#)
 modes for triggering, [1106](#)
 Modify softkey, [56](#)
 modulating signal frequency, waveform generator, [1251](#), [1253](#)
 modulation (waveform generator), enabling/disabling, [1259](#)

modulation analysis, [660](#)
 modulation analysis source (voltage or current), [661](#)
 modulation analysis, type of, [662](#)
 modulation type, waveform generator, [1260](#)
 MOSI data pattern width, [943](#)
 MOSI data pattern, SPI trigger, [942](#)
 MOSI data source, SPI trigger, [939](#), [1335](#)
 most significant byte first, [1203](#)
 move cursors, [1316](#), [1317](#)
 msbfirst, [1203](#)
 MSG (Message), [207](#), [209](#)
 MSO models, [6](#)
 MSS (Master Summary Status), [209](#)
 MTEEnable (Mask Test Event Enable Register), [231](#)
 MTERegister[:EVENT] (Mask Test Event Event Register), [233](#), [1369](#)
 MTESt commands, [581](#)
 multi-channel waveform data, save, [738](#)
 multiple commands, [1389](#)
 multiple queries, [71](#)
 multiplier value for SENT Fast Channel Signal, [912](#)
 multiply math function, [418](#), [1217](#)
 multiply math function as g(t) source, [1300](#)

N

N2820A high sensitivity current probe, [504](#), [505](#), [506](#), [507](#), [508](#), [509](#)
 N8900A Infiniium Offline oscilloscope analysis software, [738](#)
 name channels, [297](#)
 name list, [354](#)
 natural logarithm math function, [419](#)
 negative glitch trigger polarity, [1132](#)
 negative pulse width, [516](#)
 negative pulse width measurement, [63](#)
 negative pulse width, power modulation analysis, [662](#)
 negative slope, [933](#), [1125](#)
 negative slope, Nth edge in burst, [1119](#)
 negative TV trigger polarity, [1175](#)
 network domain password, [442](#)
 network domain user name, [444](#)
 network printer address, [439](#)
 network printer domain, [441](#)
 network printer slot, [443](#)
 network printer, apply connection settings, [440](#)
 new line (NL) terminator, [183](#), [1386](#)
 new load current, transient response analysis, [713](#)
 NFC trigger commands, [1136](#)
 nibble order for SENT Fast Channel Signal, [914](#)
 NL (new line) terminator, [183](#), [1386](#)
 NM bits (CXPI), triggering on, [823](#)
 NMONotonic, dual demo signal, [328](#)

noise floor, [706](#), [709](#)
 noise reject filter, [1107](#)
 noise waveform generator output, [1244](#)
 noise, adding to waveform generator output, [1258](#)
 noisy sine waveform demo signal, [326](#)
 non-core commands, [1384](#)
 non-interlaced GENeric mode, [1177](#)
 non-volatile memory, label list, [274](#), [336](#), [354](#)
 normal acquisition type, [253](#), [1198](#)
 normal trigger sweep mode, [1097](#)
 notices, [2](#)
 NR1 number format, [183](#)
 NR3 number format, [183](#)
 Nth edge burst trigger source, [1120](#)
 Nth edge burst triggering, [1098](#)
 Nth edge in a burst idle, [1118](#)
 Nth edge in burst slope, [1119](#)
 Nth edge of burst counter, [1117](#)
 Nth edge of Edge Then Edge trigger, [1113](#)
 NTSC, [1173](#), [1177](#)
 null frame count (FlexRay), [829](#)
 null offset, [706](#)
 NULL string, [1064](#)
 number format, [183](#)
 number of nibbles, SENT message, [907](#)
 number of points, [258](#), [1208](#), [1210](#)
 number of time buckets, [1208](#), [1210](#)
 numeric variables, [70](#)
 numeric variables, reading query results into multiple, [72](#)
 nwidth, [516](#)

O

obsolete and discontinued commands, [1283](#)
 obsolete commands, [1384](#)
 occurrence reported by magnitude, [1318](#)
 offset, [395](#)
 offset for Ax + B math operation, [416](#)
 offset value for channel voltage, [298](#)
 offset value for FFT function, [382](#), [384](#)
 offset value for selected function, [417](#), [423](#)
 offset value for SENT Fast Channel Signal, [913](#)
 offset, waveform generator, [1272](#)
 one values in waveform data, [1205](#)
 OPC (Operation Complete) command, [198](#)
 OPC (Operation Complete) status bit, [193](#), [195](#)
 OPEE (Operation Status Enable Register), [235](#)
 Open method, [65](#)
 operating configuration, [197](#), [1080](#)
 operating state, [205](#)
 operation complete, [198](#)
 operation status condition register, [237](#)
 Operation Status Condition Register (:OPERRegister:CONDition), [237](#), [1364](#)

- operation status conditions occurred, 209
 - Operation Status Enable Register (OPEE), 235
 - operation status event register, 239
 - Operation Status Event Register (:OPERRegister[:EVENT]), 239, 1363
 - operations for function, 418
 - operators, math, 418
 - OPERRegister:CONDition (Operation Status Condition Register), 237, 1364
 - OPERRegister[:EVENT] (Operation Status Event Register), 239, 1363
 - OPT (Option Identification), 199
 - optional syntax terms, 183
 - options, 199
 - OR trigger commands, 1146
 - order of digital channels on display, 1297
 - order of output, 1203
 - oscilloscope connection, opening, 65
 - oscilloscope connection, verifying, 57
 - oscilloscope external trigger, 365
 - oscilloscope models, 3
 - oscilloscope rate, 264
 - oscilloscope, connecting, 55
 - oscilloscope, initialization, 62
 - oscilloscope, operation, 6
 - oscilloscope, program structure, 62
 - oscilloscope, setting up, 55
 - oscilloscope, setup, 66
 - output control, demo signals, 331
 - output control, waveform generator, 1262
 - output load impedance, waveform generator, 1263
 - output messages ready, 209
 - output polarity, waveform generator, 1265
 - output power, 571
 - output queue, 198, 1358
 - output queue clear, 191
 - output ripple, 577
 - output ripple analysis, 682
 - output sequence, 1203
 - output source, Control Loop Response (Bode) power analysis, 636
 - output source, Power Supply Rejection Ratio (PSRR) power analysis, 677
 - overall pass/fail status for current harmonics analysis, 654
 - overlapped commands, 1392
 - overload, 307
 - Overload Event Enable Register (OVL), 241
 - Overload Event Register (:OVLRegister), 1366
 - Overload Event Register (OVL), 243
 - overload frame count (CAN), 781
 - overload protection, 241, 243
 - overshoot of waveform, 517
 - overshoot percent for transient response analysis, 693
 - overvoltage, 307
 - OVL (Overload Event Enable Register), 241
 - OVL (Overload Event Register), 243
 - OVL bit, 237, 239
 - OVLRegister (Overload Event Register), 1366
- ## P
- P1080L24HZ, 1173, 1177
 - P1080L25HZ, 1173, 1177
 - P1080L50HZ, 1173, 1177
 - P1080L60HZ, 1173, 1177
 - P480L60HZ, 1173, 1177
 - P720L60HZ, 1173, 1177
 - PAL, 1173, 1177
 - palette for hardcopy, 445
 - palette for image, 735
 - PAL-M, 1173, 1177
 - parameters for delay measurement, 502
 - parametric measurements, 490
 - parity, 957
 - parity bits, LIN serial decode bus, 875
 - parser, 216, 1389
 - pass, self test, 211
 - pass/fail status (overall) for current harmonics analysis, 654
 - password, network domain, 442
 - path information, recall, 722
 - path information, save, 740
 - pattern, 866, 867, 868
 - pattern data, I2S, 855
 - pattern data, LIN, 883
 - pattern duration, 1129, 1130, 1152, 1153
 - pattern for pattern trigger, 1149
 - pattern format, I2S, 857
 - pattern format, LIN, 886
 - pattern length, 800, 885
 - PATtern trigger commands, 1148
 - pattern trigger format, 1151
 - pattern trigger qualifier, 1154
 - pattern triggering, 1098
 - pattern width, 941, 943
 - pause pulse, SENT messages, 908
 - peak current, 572
 - peak data, 1199
 - peak detect, 265
 - peak detect acquisition type, 254, 1199
 - PEAK SEARch commands, 985
 - peak-peak math function, 420
 - peak-to-peak vertical value measurement, 508, 548
 - pending operations, 198
 - percent of waveform overshoot, 517
 - percent thresholds, 500
 - period measured to calculate phase, 521
 - period measurement, 63, 490, 520
 - Period, power modulation analysis, 662
 - period, waveform generator, 1267
 - persistence, waveform, 342, 357
 - phase angle, demo signals, 330
 - phase measured between channels, 521
 - phase measurements, 539
 - phase measurements with X cursors, 465
 - phase shifted demo signals, 326
 - PLL Locked bit, 229
 - PNG format screen image data, 351
 - pod, 615, 617, 618, 619, 1217, 1292
 - POD commands, 615
 - POD data format, 1201
 - pod, stop displaying, 224
 - points, 258, 1208, 1210
 - points in waveform data, 1198
 - points per decade, Control Loop Response (Bode) power analysis, 634
 - points per decade, Power Supply Rejection Ratio (PSRR) power analysis, 675
 - polarity, 958, 1175
 - polarity for glitch search, 981
 - polarity for glitch trigger, 1132
 - polarity, runt search, 991
 - polarity, runt trigger, 1157
 - polling synchronization with timeout, 1376
 - polling wait, 1374
 - PON (Power On) status bit, 193, 195
 - portrait layout for hardcopy, 438
 - position, 337, 462, 1088, 1094
 - position cursors, 1316, 1317
 - position in zoomed view, 1094
 - position waveforms, 1297
 - positive glitch trigger polarity, 1132
 - positive pulse width, 524
 - positive pulse width measurement, 63
 - positive pulse width, power modulation analysis, 662
 - positive slope, 933, 1125
 - positive slope, Nth edge in burst, 1119
 - positive TV trigger polarity, 1175
 - positive width, 524
 - power analysis, enabling, 643
 - POWer commands, 621
 - power factor, 567
 - power factor for IEC 61000-3-2 Standard Class C, 649
 - power loss, 573
 - power phase angle, 561
 - power quality analysis, 681
 - power supply rejection ratio (PSRR), 670, 672, 673
 - Power Supply Rejection Ratio (PSRR) power analysis settings, 669
 - preamble data, 1212
 - preamble metadata, 1197
 - predefined logic threshold, 1292
 - predefined threshold voltages, 1338
 - present working directory, recall operations, 722
 - present working directory, save operations, 740
 - preset conditions, 1069
 - preshoot measured on waveform, 523
 - previously stored configuration, 201
 - print command, 245
 - print job, start, 447
 - print mask test failures, 602
 - print query, 1331

printer driver for hardcopy, 1309
 printer, active, 434
 printing, 432
 printing in grayscale, 1307
 probe, 1123
 probe attenuation affects channel voltage range, 308
 probe attenuation factor (external trigger), 367
 probe attenuation factor for selected channel, 299
 probe head type, 300
 probe ID, 301
 probe sense for oscilloscope, 1295, 1299
 probe skew value, 304, 1293
 process sigma, mask test run, 605
 program data, 1386
 program data syntax rules, 1388
 program initialization, 62
 program message, 65, 190
 program message syntax, 1385
 program message terminator, 1386
 program structure, 62
 programming examples, 6, 1393
 protecting against calibration, 283
 protection, 241, 243, 307
 protection lock, 1072
 PTYPE byte (CXPI), trigger when present, 816
 PTYPE frames, CXPI, 813
 pulse waveform generator output, 1244
 pulse width, 516, 524
 pulse width duration trigger, 1129, 1130, 1134
 pulse width measurement, 63, 490
 pulse width trigger, 1107
 pulse width trigger level, 1131
 pulse width triggering, 1098
 pulse width, waveform generator, 1247
 pwidth, 524
 Python, VISA COM example, 1420
 Python, VISA example, 1467, 1473
 PyVISA 1.5 and older, 1467
 PyVISA 1.6 and newer, 1473

Q

qualifier, 1134
 qualifier for glitch search, 982
 qualifier, runt search, 992
 qualifier, runt trigger, 1158
 qualifier, transition search, 996
 qualifier, transition trigger, 1168
 qualifier, trigger duration, 1152, 1153
 qualifier, trigger pattern, 1154
 queries, multiple, 71
 query error detected in Standard Event Status, 195
 query responses, block data, 70
 query responses, reading, 69

query results, reading into numeric variables, 70
 query results, reading into string variables, 70
 query return values, 1391
 query setup, 432, 455, 490, 1080
 query subsystem, 268, 334
 querying setup, 291
 querying the subsystem, 1098
 queues, clearing, 1370
 quick reference, commands, 75
 quoted ASCII string, 184
 QYE (Query Error) status bit, 193, 195

R

ramp symmetry, waveform generator, 1248
 ramp symmetry, waveform generator modulating signal, 1257
 ramp waveform generator output, 1244
 range, 395, 1095
 range for channels, 308
 range for duration trigger, 1155
 range for external trigger, 368
 range for full-scale vertical axis, 383, 422
 range for glitch search, 983
 range for glitch trigger, 1134
 range for time base, 1089
 range of offset values, 298
 range qualifier, 1133
 range, I2S, 858
 ranges, value, 184
 rate, 264
 ratio measurements with X cursors, 465
 ratio measurements with Y cursors, 472
 ratio of AC RMS values measured between channels, 549
 Ratio, power modulation analysis, 662
 raw acquisition record, 1210
 RCL (Recall), 201
 Rds (dynamic ON resistance) waveform, 705
 Rds(on) power measurement, 574
 Rds(on) value for conduction calculation, 707
 reactive power, 575
 read configuration, 197
 ReadIEEEBlock method, 65, 69, 71
 ReadList method, 65, 69
 ReadNumber method, 65, 69
 readout, 1312
 ReadString method, 65, 69
 real power, 576
 Real Power source in Class D harmonics analysis, 650
 real-time acquisition mode, 257
 recall, 201, 716, 1080
 recall arbitrary waveform, 717
 recall CAN symbolic data, 718
 RECall commands, 715
 recall filename, 719, 1242
 recall LIN symbolic data, 720
 recall mask, 721
 recall path information, 722
 recall reference waveform, 724
 recall setup, 723
 recalling and saving data, 342
 receiver width, I2S, 848
 RECTangular window for transient signals, 389, 411
 reference, 395
 reference for time base, 1337
 reference point, FFT Phase, 408
 reference waveform save source, 753
 reference waveform, recall, 724
 reference waveform, save, 754
 reference waveforms, clear, 1275
 reference waveforms, display, 1276
 reference waveforms, label, 1277
 reference waveforms, save to, 1278
 reference waveforms, skew, 1279
 reference waveforms, Y offset, 1280
 reference waveforms, Y range, 1281
 reference waveforms, Y scale, 1282
 reference, lister, 452
 reference, time base, 1090
 registers, 194, 201, 205, 218, 231, 233, 235, 237, 239, 241, 243
 registers, clearing, 1370
 reject filter, 1124
 reject high frequency, 1101
 reject noise, 1107
 relative standard deviation, 538
 remote command logging, enable/disable, 1073, 1077
 remote control examples, 1393
 Remote Terminal Address (RTA), M1553 trigger, 895
 remove cursor information, 457
 remove labels, 353
 remove message from display, 1064
 reorder channels, 219
 repetitive acquisitions, 246
 report errors, 1065
 report transition, 539, 541
 reporting status, 1349
 reporting the setup, 1098
 request service, 209
 Request-for-OPC flag clear, 191
 reset, 202
 reset conditions, 202
 reset defaults, waveform generator, 1268
 reset mask statistics, 593
 reset measurements, 350
 resolution of printed copy, 1307
 resource session object, 65
 ResourceManager object, 65
 restore configurations, 197, 201, 205, 1080
 restore labels, 353
 restore setup, 201
 return values, query, 1391
 returning acquisition type, 265

- returning number of data points, 258
 - RF burst demo signal, 327
 - right time base reference, 1090
 - ringing pulse demo signal, 326
 - ripple (output) analysis, 682
 - ripple, output, 577
 - rise time measurement, 490
 - rise time of positive edge, 528
 - Rise Time, power modulation analysis, 662
 - rising edge count measurement, 519
 - rising pulse count measurement, 522
 - RMS - AC, power modulation analysis, 662
 - RMS value measurement, 509, 550
 - roll time base mode, 1087
 - root (:) commands, 213, 216
 - root level commands, 3
 - RQL (Request Control) status bit, 193, 195
 - RQS (Request Service), 209
 - RS-232/UART triggering, 756
 - R-sense resistor value, N2825A user-defined R-sense head, 303
 - RST (Reset), 202
 - rules, tree traversal, 1389
 - rules, truncation, 1386
 - run, 210, 246
 - Run bit, 237, 239
 - run count, current harmonics analysis, 652
 - run mode, mask test, 600
 - running configuration, 205, 1080
 - RUNT SEARCh commands, 990
 - runt search polarity, 991
 - runt search qualifier, 992
 - runt search source, 993
 - runt search, pulse time, 994
 - RUNT trigger commands, 1156
 - runt trigger polarity, 1157
 - runt trigger qualifier, 1158
 - runt trigger source, 1159
 - runt trigger time, 1160
 - Rx frame count (UART), 954
 - Rx source, 959
- S**
- sample rate, 3, 264
 - sampled data, 1296
 - sampled data points, 1205
 - SAV (Save), 205
 - save, 205, 727
 - save arbitrary waveform, 729
 - SAVE commands, 725
 - save current harmonics analysis results, 739
 - save filename, 730
 - save image, 731
 - save image with inksaver, 734
 - save mask, 736, 737
 - save mask test failures, 603
 - save path information, 740
 - save reference waveform, 754
 - save setup, 747
 - save to reference waveform location, 1278
 - save waveform data, 748
 - saved image, area, 1333
 - saving and recalling data, 342
 - SBUS A429 commands, 760
 - SBUS CAN commands, 777
 - SBUS commands, 755
 - SBUS CXPI commands, 807
 - SBUS I2S commands, 843
 - SBUS SENT commands, 897
 - SBUS <n> commands, general, 757
 - scale, 385, 424, 1092, 1096
 - scale factors output on hardcopy, 435, 732
 - scale for channels, 309
 - scale units for channels, 310
 - scale units for external trigger, 369
 - scaling display factors, 299
 - SCPI commands, 73
 - SCPI.NET example in C#, 1500
 - SCPI.NET example in IronPython, 1512
 - SCPI.NET example in Visual Basic .NET, 1506
 - SCPI.NET examples, 1500
 - scratch measurements, 1311
 - screen area for hardcopy print, 433
 - screen area for saved image, 1333
 - screen display of logged remote commands, enable/disable, 1075
 - screen image data, 351
 - SDI pattern, ARINC 429 trigger, 773, 1004
 - SEARCh commands, 969
 - SEARCh commands, A429, 1000
 - SEARCh commands, CAN, 1006
 - SEARCh commands, EDGE, 975
 - SEARCh commands, FLEXray, 1016
 - SEARCh commands, general, 970
 - SEARCh commands, GLITCh, 978
 - SEARCh commands, I2S, 1022
 - SEARCh commands, IIC, 1028
 - SEARCh commands, LIN, 1035
 - SEARCh commands, M1553, 1044
 - SEARCh commands, PEAK, 985
 - SEARCh commands, RUNT, 990
 - SEARCh commands, SENT, 1048
 - SEARCh commands, SPI, 1053
 - SEARCh commands, TRANSition, 995
 - SEARCh commands, UART, 1057
 - search event (found) times, saving, 745
 - search for found event, 972
 - search mode, 973
 - search state, 974
 - search, edge slope, 976
 - search, edge source, 977
 - SECAM, 1173, 1177
 - seconds per division, 1092
 - segmented memory acquisition times, 746
 - segmented waveform save option, 752
 - segments, analyze, 259
 - segments, count of waveform, 1215
 - segments, setting number of memory, 260
 - segments, setting the index, 261
 - segments, time tag, 1216
 - select measurement channel, 531
 - self-test, 211
 - sensing a channel probe, 1295
 - sensing a external trigger probe, 1299
 - sensitivity of oscilloscope input, 299
 - SENT demo signal, 329
 - SENT enhanced serial message ID and data lengths, 928
 - SENT fast channel data search value, 1049
 - SENT fast channel data trigger setting, 923
 - SENT FAST data, 1221
 - SENT input source, 918
 - SENT percent tolerance variation trigger, 929
 - SENT SEARCh commands, 1048
 - SENT search mode, 1050
 - SENT serial bus commands, 897
 - SENT signal length setting, 910
 - SENT signals display setting, 909
 - SENT slow channel data search value, 1051
 - SENT slow channel ID and data trigger data setting, 924
 - SENT slow channel ID search value, 1052
 - SENT slow channel ID trigger setting, 926
 - SENT SLOW data, 1221
 - SENT trigger mode, 921
 - SENT triggering, 756
 - sequential commands, 1392
 - serial clock, 864, 936
 - serial data, 865
 - serial decode bus, 755
 - serial decode bus display, 758
 - serial decode mode, 759
 - serial frame, 937
 - serial number, 247
 - service request, 209
 - Service Request Enable Register (SRE), 207, 1356
 - set center frequency, 374, 404
 - set cursors, 1316, 1317
 - set date, 1063
 - set time, 1082
 - set up oscilloscope, 55
 - setting digital display, 335
 - setting digital label, 274, 336
 - setting digital position, 337
 - setting digital threshold, 339
 - setting display, 403
 - setting external trigger level, 365
 - setting impedance for channels, 295
 - setting inversion for channels, 296
 - setting pod display, 617
 - setting pod size, 618
 - setting pod threshold, 619
 - settings, 201, 205
 - settings, instrument, 432
 - setup, 254, 268, 291, 334, 342, 432, 1080
 - setup and hold trigger clock source, 1163
 - setup and hold trigger data source, 1164
 - setup and hold trigger hold time, 1165

- setup and hold trigger setup time, 1166
- setup and hold trigger slope, 1162
- setup configuration, 201, 205, 1080
- setup defaults, 202, 1069
- setup memory, 201
- setup reported, 1098
- setup time, setup and hold trigger, 1166
- setup, recall, 723
- setup, save, 747
- shape of modulation signal, waveform generator, 1256
- SHoLd trigger commands, 1161
- short form, 5, 1386
- show channel labels, 353
- show measurements, 490, 530
- SICL example in C, 1480
- SICL example in Visual Basic, 1489
- SICL examples, 1480
- sidebar, display, 356
- sigma, mask test run, 605
- signal speed, ARINC 429, 770
- signal type, 305
- signal type, ARINC 429, 768
- signal value, CAN symbolic search, 1015
- signal value, CAN symbolic trigger, 806
- signal value, LIN symbolic search, 1043
- signal value, LIN symbolic trigger, 889
- signal, CAN symbolic search, 1014
- signal, CAN symbolic trigger, 805
- signal, LIN symbolic search, 1042
- signal, LIN symbolic trigger, 888
- signed data, 1200
- simple command headers, 1387
- sine cardinal waveform generator output, 1245
- sine waveform demo signal, 326
- sine waveform generator output, 1243
- single acquisition, 248
- single-ended probe heads, 300
- single-ended signal type, 305
- single-shot demo signal, 326
- single-shot DUT, synchronizing with, 1378
- single-shot waveform generator output, 1266
- size, 618
- size, digital channels, 338
- skew, 304, 1293
- skew reference waveform, 1279
- slew rate power analysis, 702
- slope, 933, 1125
- slope (direction) of waveform, 1318
- slope not valid in TV trigger mode, 1125
- slope parameter for delay measurement, 502
- slope, arming edge, Edge Then Edge trigger, 1110
- slope, Nth edge in burst, 1119
- slope, setup and hold trigger, 1162
- slope, transition search, 997
- slope, transition trigger, 1169
- slope, trigger edge, Edge Then Edge trigger, 1114
- slot, network printer, 443
- SLOW data, SENT, 1221
- smoothing acquisition type, 1199
- smoothing math function, 419
- smoothing math function, number of points, 425
- snapshot all measurement, 492
- software version, 196
- source, 531, 769, 793, 878
- source (voltage or current) for slew rate analysis, 703
- source channel, M1553, 893
- source for function, 1303
- source for glitch search, 984
- source for Nth edge burst trigger, 1120
- source for trigger, 1126
- source for TV trigger, 1176
- source function for FFT peak search, 988
- source input for FFT function, 386
- source input for function, first, 426
- source input for function, second, 428
- source, arming edge, Edge Then Edge trigger, 1111
- source, automask, 588
- source, FLEXray, 833
- source, mask test, 613
- source, NFC trigger, 1139
- source, runt search, 993
- source, runt trigger, 1159
- source, save reference waveform, 753
- source, transition trigger, 998, 1170
- source, trigger edge, Edge Then Edge trigger, 1115
- source, waveform, 1217
- span, 418
- span of frequency on display, 387, 409
- Spec error counter (CAN), 783
- specify measurement, 531
- speed of ARINC 429 signal, 770
- SPI, 933
- SPI clock timeout, 934
- SPI decode bit order, 932
- SPI decode word width, 945
- SPI demo signal, 328
- SPI MISO data, 1221
- SPI SEARCh commands, 1053
- SPI serial search, data, 1055
- SPI serial search, data width, 1056
- SPI serial search, mode, 1054
- SPI trigger, 935, 941, 943
- SPI trigger clock, 936
- SPI trigger commands, 930
- SPI trigger frame, 937
- SPI trigger MISO data pattern, 940
- SPI trigger MOSI data pattern, 942
- SPI trigger type, 944
- SPI trigger, MISO data source, 938
- SPI trigger, MOSI data source, 939, 1335
- SPI triggering, 756
- square math function, 419
- square root math function, 419
- square wave duty cycle, waveform generator, 1249
- square waveform generator output, 1243
- SRE (Service Request Enable Register), 207, 1356
- SRQ (Service Request interrupt), 227, 231, 235
- SSM pattern, ARINC 429 trigger, 774, 1005
- standard deviation measured on waveform, 529
- Standard Event Status Enable Register (ESE), 192, 1361
- Standard Event Status Register (ESR), 194, 1360
- standard for CAN FD decode, 788
- standard for video, 1177
- standard, LIN, 879
- standard, NFC trigger, 1140
- start acquisition, 210, 225, 246, 248
- start and stop edges, 500
- start cursor, 1316
- start frequency, FFT math function, 379, 405
- start measurement, 490
- start print job, 447
- start time, 1134, 1316
- start time marker, 1313
- starting bit for SENT Fast Channel Signal, 916
- starting byte of data, CXPI trigger, 819
- state memory, 205
- state of instrument, 197, 1080
- statistics increment, 535
- statistics reset, 537
- statistics results, 525
- statistics, max count, 536
- statistics, relative standard deviation, 538
- statistics, type of, 533
- status, 208, 249, 251
- Status Byte Register (STB), 206, 208, 209, 1354
- status data structure clear, 191
- status registers, 72
- status reporting, 1349
- STB (Status Byte Register), 206, 208, 209, 1354
- steady state output voltage expected, 697, 698, 699
- step size for frequency span, 387, 409
- stop, 225, 250
- stop acquisition, 250
- stop cursor, 1317
- stop displaying channel, 224
- stop displaying math function, 224
- stop displaying pod, 224
- stop frequency, FFT math function, 380, 406
- stop on mask test failure, 604
- stop time, 1134, 1317
- storage, 205
- store instrument setup, 197, 205

store setup, 205
 storing calibration information, 280
 string variables, 70
 string variables, reading multiple query results into, 71
 string variables, reading query results into multiple, 71
 string, quoted ASCII, 184
 subnet mask, 56
 subsource, waveform source, 1221
 subsystem commands, 3, 1389
 subtract math function, 418, 1217
 subtract math function as g(t) source, 1300
 sweep mode, trigger, 1097, 1108
 sweep speed set to fast to measure fall time, 511
 sweep speed set to fast to measure rise time, 528
 switch disable, 1066
 switching level, current, 706
 switching level, voltage, 709
 switching loss per cycle, 563
 switching loss power analysis, 704
 sync break, LIN, 880
 sync frame count (FlexRay), 831
 syntax elements, 183
 syntax rules, program data, 1388
 syntax, optional terms, 183
 syntax, program message, 1385
 SYSTEM commands, 1061
 system commands, 1063, 1064, 1065, 1066, 1080, 1082
 system commands introduction, 1062

T

table of current harmonics results, 646
 tdelta, 1312
 tedge, 539
 Tektronix probe model number, 302
 telnet ports 5024 and 5025, 1205
 Telnet sockets, 73
 temporary message, 1064
 TER (Trigger Event Register), 251, 1357
 termination conditions, mask test, 600
 test sigma, mask test run, 605
 test, self, 211
 text, writing to display, 1064
 THD (total harmonics distortion), 655
 threshold, 339, 619, 1292, 1338
 threshold for FFT peak search, 989
 threshold voltage (lower) for measurement, 1310
 threshold voltage (upper) for measurement, 1319
 thresholds, 500, 1313
 thresholds used to measure period, 520
 thresholds, how autoscale affects, 219
 time base, 1087, 1088, 1089, 1092, 1337
 time base commands introduction, 1086

time base reference, 1090
 time base reset conditions, 203, 1070
 time base window, 1094, 1095, 1096
 time between arm and trigger, NFC arm and trigger event, 1138
 time between points, 1312
 time buckets, 255, 256
 time delay, 1337
 time delay, Edge Then Edge trigger, 1112
 time delta, 1312
 time difference between data points, 1225
 time duration, 1134, 1152, 1153, 1155
 time holdoff for trigger, 1102
 time interval, 539, 541, 1312
 time interval between trigger and occurrence, 1318
 time marker sets start time, 1313
 time measurements with X cursors, 465
 time per division, 1089
 time record, 389, 411
 time reference, lister, 452
 time specified, 551
 time, calibration, 287
 time, mask test run, 606
 time, runt pulse search, 994
 time, runt trigger, 1160
 time, start marker, 1316
 time, stop marker, 1317
 time, system, 1082
 time, transition search, 999
 time, transition trigger, 1171
 time/div, how autoscale affects, 219
 time-at-max measurement, 1314
 time-at-min measurement, 1315
 TIMEbase commands, 1085
 timebase vernier, 1093
 TIMEbase:MODE, 68
 time-ordered label list, 354
 timeout enable, NFC arm and trigger event, 1144
 timeout occurred, NFC arm and trigger event, 1143
 timeout period, NFC arm and trigger event, 1145
 timeout, SPI clock, 934
 timing measurement, 490
 title channels, 297
 title, mask test, 614
 tolerance for determining valid SENT sync pulses, 920
 tolerance, automask, 590, 591
 top of waveform value measured, 552
 total frame count (CAN), 784
 total frame count (FlexRay), 832
 total harmonics distortion (THD), 655
 total waveforms in mask test, 595
 touchscreen on/off, 1083
 trace memory, 249
 track measurements, 530
 transfer instrument state, 197, 1080
 transforms, math, 418
 transient response, 578

transient response analysis, 710, 711, 714
 TRANSition SEARCh commands, 995
 transition search qualifier, 996
 transition search slope, 997
 transition search time, 999
 transition trigger qualifier, 1168
 transition trigger slope, 1169
 transition trigger source, 998, 1170
 transition trigger time, 1171
 transmit word size, I2S, 860
 transparent screen background, remote command logging, 1078
 tree traversal rules, 1389
 trend measurement, 429
 TRG (Trigger), 207, 209, 210
 TRIG OUT BNC, 281
 trigger armed event register, 237, 239
 trigger burst, UART, 962
 trigger channel source, 1135, 1176
 TRIGger commands, 1097
 TRIGger commands, general, 1099
 trigger data, UART, 963
 TRIGger DELay commands, 1109
 trigger duration, 1152, 1153
 TRIGger EBURst commands, 1116
 TRIGger EDGE commands, 1121
 trigger edge coupling, 1122
 trigger edge slope, 1125
 trigger edge slope, Edge Then Edge trigger, 1114
 trigger edge source, Edge Then Edge trigger, 1115
 trigger event bit, 251
 Trigger Event Register (TER), 1357
 trigger event, NFC trigger, 1141
 TRIGger FLEXray commands, 824
 TRIGger GLITCh commands, 1127
 trigger holdoff, 1102
 trigger idle, UART, 964
 TRIGger IIC commands, 862
 trigger level auto set up, 1103
 trigger level constants, 299
 trigger level voltage, 1123
 trigger level, high, 1104
 trigger level, low, 1105
 TRIGger LIN commands, 872
 TRIGger M1553 commands, 890
 TRIGger NFC commands, 1136
 trigger occurred, 209
 TRIGger OR commands, 1146
 TRIGger PATtern commands, 1148
 trigger pattern qualifier, 1154
 trigger qualifier, UART, 965
 trigger reset conditions, 203, 1070
 TRIGger RUNT commands, 1156
 TRIGger SHOLd commands, 1161
 trigger SPI clock slope, 933
 TRIGger SPI commands, 930
 trigger status bit, 251
 trigger sweep mode, 1097
 TRIGger TV commands, 1167, 1172
 trigger type, ARINC 429, 776, 1002

- trigger type, SPI, 944
 - trigger type, UART, 966
 - TRIGger UART commands, 946
 - TRIGger USB commands, 1182
 - TRIGger ZONE commands, 1187
 - trigger, ARINC 429 source, 769
 - trigger, CAN, 794
 - trigger, CAN FD sample point, 787
 - trigger, CAN pattern data length, 800
 - trigger, CAN pattern ID mode, 803
 - trigger, CAN sample point, 789
 - trigger, CAN signal baudrate, 790
 - trigger, CAN signal definition, 791
 - trigger, CAN source, 793
 - trigger, duration greater than, 1152
 - trigger, duration less than, 1153
 - trigger, duration range, 1155
 - trigger, edge coupling, 1122
 - trigger, edge level, 1123
 - trigger, edge reject, 1124
 - trigger, edge slope, 1125
 - trigger, edge source, 1126
 - trigger, FLEXray, 834
 - trigger, FLEXray error, 835
 - trigger, FLEXray event, 838
 - trigger, force a, 1100
 - trigger, glitch greater than, 1129
 - trigger, glitch less than, 1130
 - trigger, glitch level, 1131
 - trigger, glitch polarity, 1132
 - trigger, glitch qualifier, 1133
 - trigger, glitch range, 1134
 - trigger, glitch source, 1135
 - trigger, high frequency reject filter, 1101
 - trigger, holdoff, 1102
 - trigger, I2S, 852
 - trigger, I2S alignment, 845
 - trigger, I2S audio channel, 854
 - trigger, I2S clock slope, 847
 - trigger, I2S CLOCksource, 849
 - trigger, I2S DATA source, 850
 - trigger, I2S pattern data, 855
 - trigger, I2S pattern format, 857
 - trigger, I2S range, 858
 - trigger, I2S receiver width, 848
 - trigger, I2S transmit word size, 860
 - trigger, I2S word select (WS) low, 861
 - trigger, I2S word select (WS) source, 851
 - trigger, IIC clock source, 864
 - trigger, IIC data source, 865
 - trigger, IIC pattern address, 866
 - trigger, IIC pattern data, 867
 - trigger, IIC pattern data 2, 868
 - trigger, IIC qualifier, 869
 - trigger, IIC signal baudrate, 877
 - trigger, IIC type, 870
 - trigger, LIN, 881
 - trigger, LIN pattern data, 883
 - trigger, LIN pattern data length, 885
 - trigger, LIN pattern format, 886
 - trigger, LIN sample point, 876
 - trigger, LIN signal definition, 1334
 - trigger, LIN source, 878
 - trigger, mode, 1106
 - trigger, noise reject filter, 1107
 - trigger, Nth edge burst source, 1120
 - trigger, Nth edge in burst slope, 1119
 - trigger, Nth edge of burst count, 1117
 - trigger, Nth edge of Edge Then Edge trigger, 1113
 - trigger, SPI clock slope, 933
 - trigger, SPI clock source, 936
 - trigger, SPI clock timeout, 934
 - trigger, SPI frame source, 937
 - trigger, SPI framing, 935
 - trigger, SPI pattern MISO width, 941
 - trigger, SPI pattern MOSI width, 943
 - trigger, sweep, 1108
 - trigger, threshold, 1338
 - trigger, TV line, 1173
 - trigger, TV mode, 1174, 1339
 - trigger, TV polarity, 1175
 - trigger, TV source, 1176
 - trigger, TV standard, 1177
 - trigger, UART base, 961
 - trigger, UART baudrate, 950
 - trigger, UART bit order, 951
 - trigger, UART parity, 957
 - trigger, UART polarity, 958
 - trigger, UART Rx source, 959
 - trigger, UART Tx source, 960
 - trigger, UART width, 967
 - trigger, USB, 1186
 - trigger, USB D- source, 1183
 - trigger, USB D+ source, 1184
 - trigger, USB speed, 1185
 - truncation rules, 1386
 - TST (Self Test), 211
 - tstart, 1316
 - tstop, 1317
 - TTL threshold voltage for digital channels, 339, 1292
 - TTL trigger threshold voltage, 1338
 - turn function on or off, 1304
 - turn off channel, 224
 - turn off channel labels, 353
 - turn off digital pod, 224
 - turn off math function, 224
 - turn off time, 569, 666, 667
 - turn on channel labels, 353
 - turn on channel number display, 1297
 - turn on time, 570, 666, 667
 - turn on/turn off analysis thresholds, 667
 - turn on/turn off time analysis, 663, 664, 665, 666
 - turning channel display on and off, 294
 - turning off/on function calculation, 403
 - turning vectors on or off, 1296
 - TV mode, 1174, 1339
 - TV trigger commands, 1167, 1172
 - TV trigger line number setting, 1173
 - TV trigger mode, 1176
 - TV trigger polarity, 1175
 - TV trigger standard setting, 1177
 - TV triggering, 1098
 - tvmode, 1339
 - Tx data, UART, 1221
 - Tx frame count (UART), 955
 - Tx source, 960
 - type of power being converted, efficiency measurement, 642
- ## U
- UART base, 961
 - UART baud rate, 950
 - UART bit order, 951
 - UART frame counters, reset, 953
 - UART parity, 957
 - UART polarity, 958
 - UART Rx source, 959
 - UART SEARCH commands, 1057
 - UART serial search, data, 1058
 - UART serial search, data qualifier, 1060
 - UART serial search, mode, 1059
 - UART trigger burst, 962
 - UART trigger commands, 946
 - UART trigger data, 963
 - UART trigger idle, 964
 - UART trigger qualifier, 965
 - UART trigger type, 966
 - UART Tx data, 1221
 - UART Tx source, 960
 - UART width, 967
 - UART/RS232 demo signal, 327
 - UART/RS-232 triggering, 756
 - units (vertical) for FFT, 388, 410
 - units per division, 309, 310, 369, 1092
 - units per division (vertical) for FFT function, 385
 - units per division (vertical) for function, 309, 424
 - units, automask, 589
 - units, X cursor, 465, 466
 - units, Y cursor, 472, 473
 - unsigned data, 1200
 - unsigned mode, 1223
 - upper threshold, 520
 - upper threshold voltage for measurement, 1319
 - uppercase characters in commands, 1385
 - URQ (User Request) status bit, 193, 195
 - USB (Device) interface, 55
 - USB source, 1183, 1184
 - USB speed, 1185
 - USB trigger, 1186
 - USB trigger commands, 1182
 - USB triggering, 1098
 - user defined channel labels, 297
 - user defined threshold, 1292
 - user event conditions occurred, 209
 - User Files directory, 722, 740
 - user name, network domain, 444
 - User's Guide, 6

user-defined Real Power in Class D harmonics analysis, 651
 user-defined threshold voltage for digital channels, 339
 user-defined trigger threshold, 1338
 USR (User Event bit), 207, 209
 utilization, CAN bus, 785

V

valid command strings, 1385
 valid pattern time, 1152, 1153
 value, 541
 value measured at base of waveform, 507, 545
 value measured at specified time, 551
 value measured at top of waveform, 552
 value ranges, 184
 values required to fill time buckets, 256
 VBA, 64, 1394
 Vce(sat) power measurement, 579
 Vce(sat) value for conduction calculation, 708
 vectors turned on or off, 1296
 vectors, display, 358
 vectors, turning on or off, 342
 vernier, channel, 311
 vernier, horizontal, 1093
 vertical adjustment, fine (vernier), 311
 vertical amplitude measurement, 505, 543
 vertical axis defined by RANGe, 383, 422
 vertical axis range for channels, 308
 vertical offset for channels, 298
 vertical peak-to-peak measured on waveform, 508, 548
 vertical scale, 309, 385, 424
 vertical scaling, 1212
 vertical threshold, 1292
 vertical units for FFT, 388, 410
 vertical value at center screen, 382, 384, 417, 423
 vertical value maximum measured on waveform, 546
 vertical value measurements to calculate overshoot, 517
 vertical value minimum measured on waveform, 547
 video line to trigger on, 1173
 video standard selection, 1177
 view, 252, 1224, 1297
 view turns function on or off, 1304
 VISA COM example in C#, 1403
 VISA COM example in Python, 1420
 VISA COM example in Visual Basic, 1394
 VISA COM example in Visual Basic .NET, 1412
 VISA example in C, 1427
 VISA example in C#, 1446
 VISA example in Python, 1467, 1473
 VISA example in Visual Basic, 1436
 VISA example in Visual Basic .NET, 1457

VISA examples, 1394, 1427
 Visual Basic .NET, SCPI.NET example, 1506
 Visual Basic .NET, VISA COM example, 1412
 Visual Basic .NET, VISA example, 1457
 Visual Basic 6.0, 65
 Visual Basic for Applications, 64, 1394
 Visual Basic, SICL library example, 1489
 Visual Basic, VISA COM example, 1394
 Visual Basic, VISA example, 1436
 visualizations, math, 420
 voltage crossing reported or not found, 1318
 voltage difference between data points, 1228
 voltage difference measured, 1320
 voltage level for active trigger, 1123
 voltage marker used to measure waveform, 1321, 1322
 voltage offset value for channels, 298
 voltage probe, 310, 369
 voltage ranges for channels, 308
 voltage ranges for external trigger, 368
 voltage source, 701
 voltage threshold, 500
 voltage, maximum expected input, 694, 695, 696

W

WAI (Wait To Continue), 212
 wait, 212
 wait for operation complete, 198
 Wait Trig bit, 237, 239
 warranty, 2
 waveform base value measured, 507, 545
 WAVEform command, 63
 WAVEform commands, 1195
 waveform data, 1197
 waveform data format, 749
 waveform data length, 750
 waveform data length, maximum, 751
 waveform data, save, 748
 waveform generator, 1234
 waveform generator amplitude, 1269
 waveform generator function, 1243
 waveform generator high-level voltage, 1270
 waveform generator load impedance, Control Loop Response (Bode) power analysis, 637
 waveform generator load impedance, Power Supply Rejection Ratio (PSRR) power analysis, 678
 waveform generator low-level voltage, 1271
 waveform generator offset, 1272
 waveform generator output control, 1262
 waveform generator output load impedance, 1263
 waveform generator output mode, 1264
 waveform generator output polarity, 1265
 waveform generator period, 1267
 waveform generator pulse width, 1247
 waveform generator ramp symmetry, 1248
 waveform generator reset defaults, 1268
 waveform generator square wave duty cycle, 1249
 waveform introduction, 1197
 waveform maximum vertical value measured, 546
 waveform minimum vertical value measured, 547
 waveform must cross voltage level to be an occurrence, 1318
 WAVEform parameters, 68
 waveform peak-to-peak vertical value measured, 508, 548
 waveform period, 520
 waveform persistence, 342
 waveform RMS value measured, 509, 550
 waveform save option for segments, 752
 waveform source, 1217
 waveform source subsource, 1221
 waveform standard deviation value measured, 529
 waveform vertical amplitude, 505, 543
 waveform voltage measured at marker, 1321, 1322
 waveform, byte order, 1203
 waveform, count, 1204
 waveform, data, 1205
 waveform, format, 1207
 waveform, points, 1208, 1210
 waveform, preamble, 1212
 waveform, type, 1222
 waveform, unsigned, 1223
 waveform, view, 1224
 waveform, X increment, 1225
 waveform, X origin, 1226
 waveform, X reference, 1227
 waveform, Y increment, 1228
 waveform, Y origin, 1229
 waveform, Y reference, 1230
 WAVEform:FORMat, 68
 waveforms, mask test run, 607
 wavegen output amplitude(s), Control Loop Response (Bode) power analysis, 638
 wavegen output amplitude(s), Power Supply Rejection Ratio (PSRR) power analysis, 679
 Web control, 73
 WGEN commands, 1231
 WGEN trigger source, 1126
 what's new, 37
 width, 967, 1134
 window, 1094, 1095, 1096
 window time, 1089
 window time base mode, 1087
 window, measurement, 553
 windows, 389, 411
 windows as filters to Fast Fourier Transforms, 389, 411

windows for Fast Fourier Transform
 functions, 389, 411
 WMemory commands, 1273
 word counter (ARINC 429), 766
 word counter (ARINC 429), reset, 765
 word format, 1207
 word format for data transfer, 1200
 word format, ARINC 429, 767
 word select (WS) low, I2S trigger, 861
 word select (WS) source, I2S, 851
 word width, SPI decode, 945
 write mode, remote command
 logging, 1073, 1079
 write text to display, 1064
 WriteIEEEBlock method, 65, 71
 WriteList method, 65
 WriteNumber method, 65
 WriteString method, 65

X

X axis markers, 455
 X cursor units, 465, 466
 X delta, 456, 464
 X delta, mask scaling, 610
 X1 and X2 cursor value difference, 456,
 464
 X1 cursor, 455, 459, 460
 X1, mask scaling, 609
 X2 cursor, 455, 462, 463
 X-axis functions, 1086
 X-increment, 1225
 X-of-max measurement, 554
 X-of-min measurement, 555
 X-origin, 1226
 X-reference, 1227
 X-Y mode, 1086, 1087

Y

Y axis markers, 455
 Y cursor units, 472, 473
 Y offset, reference waveform, 1280
 Y range, reference waveform, 1281
 Y scale, reference waveform, 1282
 Y1 and Y2 cursor value difference, 471
 Y1 cursor, 455, 460, 468, 471
 Y1, mask scaling, 611
 Y2 cursor, 455, 463, 470, 471
 Y2, mask scaling, 612
 Y-axis value, 1229
 Y-increment, 1228
 Y-origin, 1229, 1230
 Y-reference, 1230

Z

zero values in waveform data, 1205
 zone 1 or zone 2 mode, 1190

zone 1 or zone 2 placement, 1191
 zone 1 or zone 2 state, 1193
 zone 1 or zone 2 validity, 1192
 zone qualified trigger source, 1188
 zone qualified trigger state, 1189
 ZONE trigger commands, 1187
 Zoom In/Out setting for N2820A
 channel, 306
 zoomed time base, 1087
 zoomed time base measurement
 window, 553
 zoomed time base mode, how autoscale
 affects, 219
 zoomed window horizontal scale, 1096

